

# Prototyping of a Low-Cost Portable Ventilation Device for Health Care in Developing Countries

Rajeev Chauhan<sup>1</sup>, Nidhi Chauhan<sup>2</sup>, Rashi Sarna<sup>3</sup>, Raman Sharma<sup>4</sup>, Kalpak Kawadgave<sup>5</sup>, Akash Gaddamwar<sup>6</sup>, Eshan Dhar<sup>7</sup>

<sup>1</sup>Assistant Professor, Department of Anesthesia and Intensive Care PGIMER Chandigarh, Punjab, India

<sup>2</sup>Assistant Professor, Department of Psychiatry GMCH-32, Chandigarh, Punjab, India

<sup>3</sup>Assistant Professor, Department of Anesthesia and Intensive Care PGIMER Chandigarh, Punjab, India

<sup>4</sup>Assistant Professor, Department of Hospital Administration PGIMER Chandigarh, Punjab, India

<sup>5</sup>Department of Mechanical Engineering, Vishwakarma Institute of Information Technology, Pune, Maharashtra,

<sup>6</sup>Director, Gyrodrive Machinerics Private Limited, Pune, Maharashtra, India

<sup>7</sup>Chief Technology Officer, Gyrodrive Machinerics Private Limited, Pune, Maharashtra, India

\*\*\*

**Abstract** - The manuscript describes the design and efficacy of a low-cost automated Artificial Manual Breathing Unit (AMBU) bag ventilation device for use in developing countries, where economic constraints do not allow expenditures on high-end conventional ventilators. This device makes use of a Bag-Valve Mask (BVM) or AMBU bag, which is automatically pressed from two sides by a linear actuator to deliver the desired tidal volume at the set respiration parameters. It is expected that the cost of manufacturing at scale shall be 1/100th when compared with conventional hospital high-end ventilators and hence will prove to be a boon for the health care industry in particular for developing nations.

**Key Words:** Ventilation device, Bag Valve Mask (BVM), RC Device, Portable and Automatic.

## 1. INTRODUCTION

Respiration in human beings is considered as a basic physiological process for survival. The factors impeding the normal physiology due to disease, trauma, infections, neuromuscular disorders, etc. may warrant external support to carry out this function. In such conditions, mechanical or assisted ventilation is the cornerstone of management and proves lifesaving. In India, on an average of 20,000 patients suffering from head injuries, chronic respiratory ailments, anaphylaxis and other injury-induced medical conditions require ventilatory support per day. The dearth of ventilators necessitates the caregivers to manually compress AMBU bags for prolonged hours.

BVM's or self-inflating AMBU bags have been used for manual resuscitation in absence of hospital ventilators since the 1940s. The BVM requires constant manual pumping by the patient's attendant however, it does not guarantee a consistent air/oxygen delivery to the patient because of fatigue, lack of knowledge about patient requirements and feedback. There are high incidents of hyperventilation, volutrauma which prove detrimental for the patients. Thus,

an urgent need for low cost controlled mechanical device is felt in the scenarios of non-availability of Intensive care Unit (ICU) beds because of shortage or financial constraints. The prototype designed is expected to facilitate the patient as close to their respiratory physiology thus increasing their chances of survival [1].

A basic concept of such a device has already been described based on a linear actuator mechanism [2]. The device consists of a squeezing actuator, supervised by a microprocessor that is responsible for controlling the salient respiration settings of tidal volume, respiration rate, PEEP (Positive end-expiratory pressure), EtCO<sub>2</sub> (End-tidal carbon dioxide), etc. The user interface for this design comprises of a 2.4-inch Thin Film Transistor (TFT) display screen, input knobs, alarm and power switch. The machine is powered by a 12V - 4 Ampere D.C. supply SMPS (Switched Mode Power Supply) and a Lithium Polymer (LiPo) battery backup provision for power failure. The device is portable measuring 40 cm x 60 cm x 60 cm while weighing 2.8 kg. In this manuscript, the feasibility of a low resource ventilator based on automated BVM has been discussed and the results of three full-scale prototypes are disclosed.

For providing ventilatory support to ailing patients, many devices are available in the market. Most of these machines are either expensive or lack features essential for adequate ventilation support. In Fig. 1 a general landscape of available ventilation support devices is shown using a cost vs functionality scale. At the lower end, manually operated resuscitators like BVM's and AMBU exist in the market providing basic minimum ventilation [3]. Such devices cost around INR 600 - 1500/- and are presently the only option in case of unavailability of hospital ventilators. In the mid-region portable pneumatic and electrical ventilators exist [4]. These come with medium level functionalities like regulated respiration rate, tidal volume, over-pressurization relief and PEEP. Although these devices are suitable enough for ICU triage, they cost around 100k - 300k INR and are still out of reach for our target market.

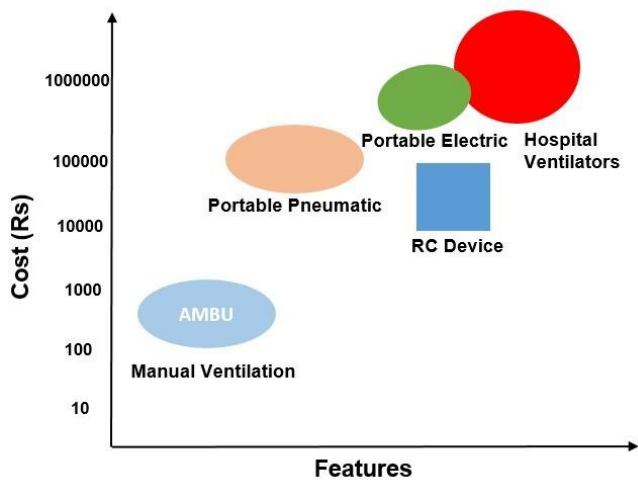


Fig -1: Cost-Feature Landscape of Ventilators in the World.

## 2. Methodology / Approach

Given the resource constraints of the targeted market and medical necessity, a set of functional requirements were devised and are summarized in Table 1.

Table -1: Key Ventilator Specifications for RC Device

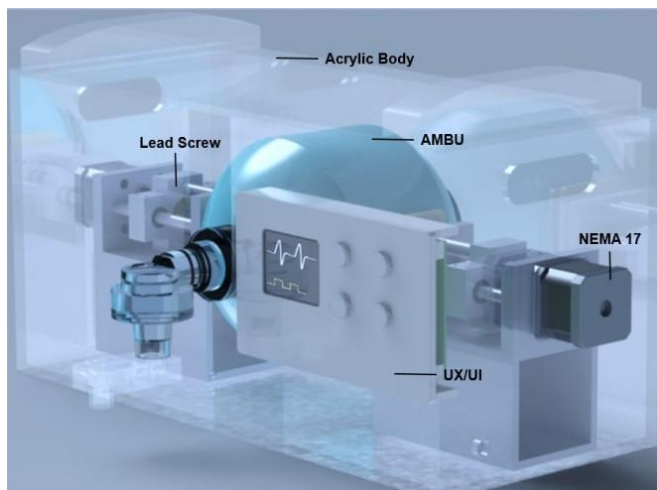
Minimum Parameters	Controllable	Device Compliance
Respiration Rate (RR) = 8 to 30 BPM		RR Knob on the user interface
Tidal Volume (TV) = 200 to 800 ml		TV Knob on the user interface
I/E Ratio = 1:2 (Better if Adjustable)		I:E Switch on the user interface
<b>Airway Pressure Management</b>		
Maximum Pressure Limit = 40 cm H <sub>2</sub> O		
Plateau Pressure Limit = 30 cm H <sub>2</sub> O		
Mechanical Pressure Relief Valve		Pressure Relief Valve is present on AMBU bag outlet
Display of Plateau Pressure and PEEP		A pressure sensor is present
PEEP of 5-15 cm H <sub>2</sub> O		Standard PEEP kit can be incorporated
<b>Failure Mode Manual Override</b>		

In case of failure of automatic Ventilation, the switch over to manual Ventilation should be fast.	The device uses a silicone AMBU bag which can be operated manually by opening the device's main door. The whole operation of manual override takes not more than 6-8 seconds
Prevention against Volutrauma	
Prevention against barotrauma	
<b>Air Quality Control</b>	
FiO <sub>2</sub> Adjustment	Has to be done by the trained medical attendant
HEPA Filtration at Patient End	A module can be installed at the AMBU end of the endotracheal tube
Heat and Moisture Control	Standard Humidifiers can be installed
<b>Alarms and Notifications</b>	
Device Failure Alarm Should be Present	The alarm gets triggered in case of disconnection, overpressure, low volume flow, etc.
<b>Power Supply</b>	
Input: 220 V - 50 Hz - 48 W	220 V AC to 12 V 4 A SMPS
Power Backup	Any standard UPS can be used

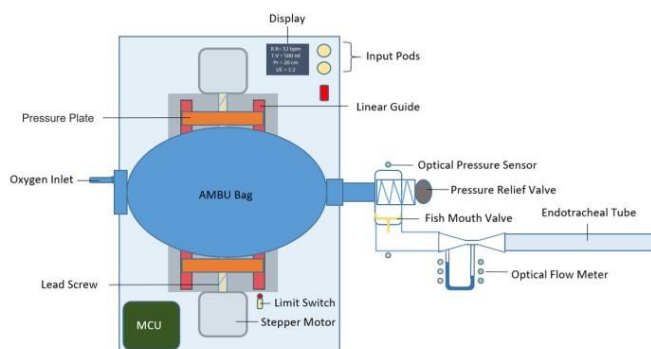
For designing the low-cost ventilator, a benchmark study was conducted to arrive at a reliable design. Different user case scenarios and requirements were enlisted which led to the formulation of a morphological chart for this design. Three different designs with various sub-components were selected for software as well as hardware simulation including flow rate meters, pressure transducers, etc. For designing the RC device MHRA UK guidelines for Rapidly Manufactured Ventilator System (RMVS) were referred [5].

The primary function of any ventilator is to provide the necessary minute ventilation to the intubated patient. There are two main mechanisms conventionally used for pumping this air, one is a forward displacement pump and the other is using a rotary centrifugal compressor. In our RC Device, we have chosen a conventional AMBU bag as the main volume displacement pump. When an AMBU bag is squeezed manually by either a single hand or both hands this causes its shape to deform. This deformation reduces the internal volume and as a sequel the gas pressure inside the bag increases. In our device, this act of squeezing is achieved by an electromechanical linear actuator. Though actuated squeezing of AMBU bags has been explored in a few research groups, none have been commercialized to date. One reason for this can be attributed to the asymmetric compression employed to squeeze the bag. This causes warping of the bag and displacement of the endotracheal tube in actual operation leading to extubation.

In the RC Device actuation of the BVM is achieved symmetrically by two linear actuators working in tandem. The linear actuators comprise a lead screw-lead nut mechanism that derives its motive power from NEMA 17 stepper motors, thus providing very precise motions. The command for motion is supervised by a microprocessor which can regulate the speed of linear motion from 0 to 36 mm/s and stroke length from 0 to 80 mm. Both the parameters of the actuator, linear speed and stroke length are related to respiration rate and tidal volume respectively. The linear motion of these two actuators is transmitted to the AMBU bag via the pressure plates connected to the lead nut body. The pressure plate material was chosen such that adherence is minimal with the AMBU bag material. This is imperative otherwise there will be excessive friction leading to higher thrust force requirements.



**Fig -2:** CAD Model of Respiration Control Device (RC Device)  
[Courtesy Gyrodrive Machineries (P) Ltd.]



**Fig -3:** Schematic of Respiration Control Device (RC Device)  
[Courtesy Gyrodrive Machineries (P) Ltd.]

As it is evident from Fig. 2 the AMBU bag is sandwiched between the two linear actuators. In this configuration, the compression action when initiated in tandem imparts almost no resultant force on the two fixed ends of the AMBU bag. Hence, no motion is transmitted to the endotracheal tubing

which was one of the main concerns while designing the machine. Symmetric compression from two diametrically opposite sides also ensures highly repeatable volume displacement which is not the case with other designs incorporating unidirectional compression.

Another problem one faces with AMBU bags is that the displaced air volume depends on the extent of squeezing action by the attendant's hand which may differ with hands of different sizes. Moreover, it is difficult to ascertain the amount of tidal volume and respiration rate been administered to the patient by the attendant as there is no feedback available. This can lead to inadequate air pressure-volume delivery further leading to ailments like barotrauma, Volutrauma, hypo or hyperventilation. In situations where patients suffer from ARDS and already have very fragile lungs, over-pressurization can cause irreparable damage to the lungs. Hence, while designing RC Device special weightage was given to machine reliability and precision with respect to the set respiratory parameters.

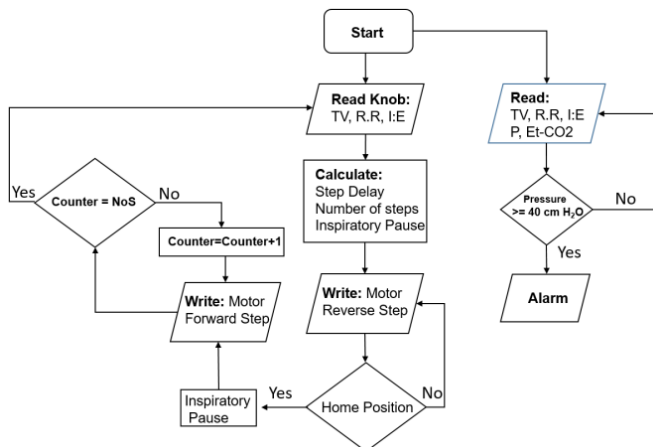
The AMBU bag compression in the RC device is achieved by linear motion of the compression plates. Hence, there exists a relation between the displaced volume, contact area, contact shape and actuator linear lead. A parametric study hence has to be conducted to arrive at the optimum design for compression plates. Repeatability of set tidal volume should be the intended goal of such a study.

For squeezing the BVM, the rotary motion of the electric motor has to be converted to linear motion. While designing the RC Device emphasis was given to the ease of motion control and lower noise levels. Moreover, the overall device cost was of utmost concern. Taking all these parameters into consideration, a lead screw-lead nut arrangement, deriving motive power out of a stepper motor, was chosen.

There are different modes in which ventilators operate and the primary control variables are pressure, volume and flow. In deciding upon the control system, one should know the control variable being controlled. In the case of ventilators, out of pressure, flow and volume, only one variable can be controlled rendering the other two as dependent variables. There are clinical advantages and disadvantages to volume and pressure control. We can just say that volume control results in more stable minute ventilation (and hence more stable blood gases) than pressure control if lung mechanics are unstable. On the other hand, pressure control allows better synchronization with the patient because the inspiratory flow is not constrained to a pre-set value. Although the ventilator must control only one variable at a time during inspiration, it is possible to begin a breath-in pressure control and (if certain criteria are met) switch to volume control or vice versa (referred to as dual-targeting).

The RC Device was designed to work in the Assist Control mode where the clinician sets a predefined Tidal Volume

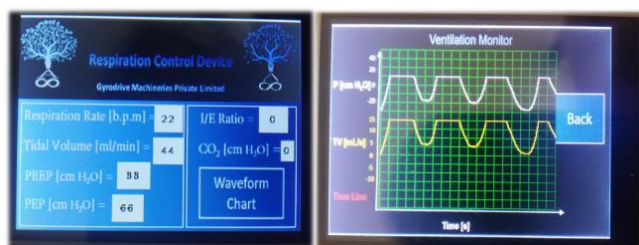
(T.V) and Respiration Rate (R.R) to achieve the desired minute ventilation. The controller reads the R.R and T.V settings and calculates the parameters for required motor rotation. As the motor used in this case is a stepper motor, the control logic calculates the number of steps and step delay as these are directly related to T.V and R.R.



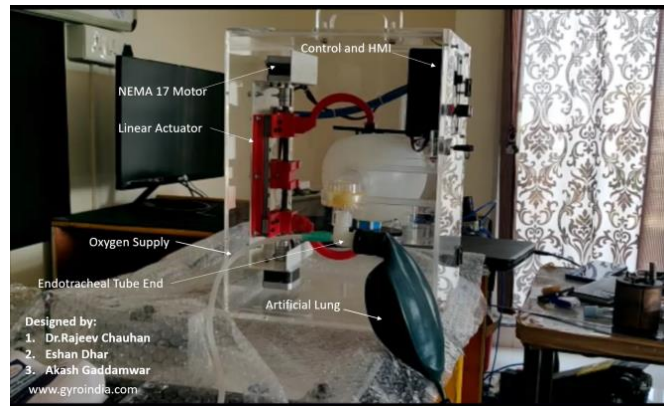
**Fig -4:** Basic Control Algorithm for RC Device [Courtesy Gyrodrive Machineries (P) Ltd.]

The user interface comprises of two knobs, one power switch, an alarm, one power button and a 2.4-inch TFT display. The two knobs are for setting the desired respiration rate and tidal volume. For setting the I:E ratio a three-position button is provided. The display screen [Fig 5] shows the salient respiratory parameters. A waveform graph displaying pressure, flow and tidal volume is also present. The buzzer alarm is for disconnection, abnormal ET pressures and power failure.

A desktop size prototype as shown in Fig 6 was developed to determine the feasibility of the design. Most of the functional mechanical components like bearing block, pressure plate, and terminal box were 3d printed using Poly-Lactic Acid (PLA), whereas the main body was fabricated using Acrylic as the latter can be laser cut, leading to fast prototyping.

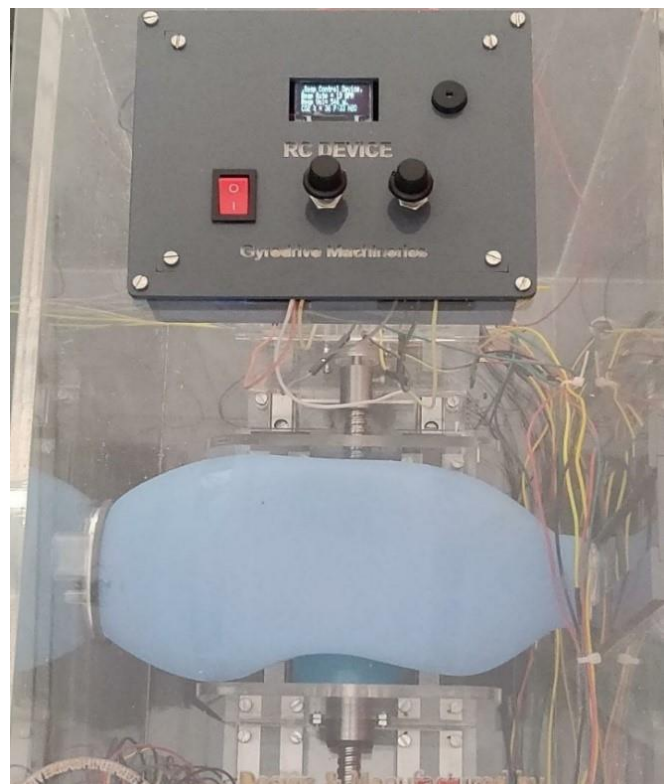


**Fig -5:** Display Screen of Prototype 3 RC Device [Courtesy Gyrodrive Machineries (P) Ltd.]



**Fig -6:** First Working Prototype of RC Device [Courtesy Gyrodrive Machineries (P) Ltd.]

The experimental setup consisted of a test lung and a mercury manometer connected to the RC Device prototype. In the preliminary testing, the device was set at a fixed tidal volume of 500 mL per breath, while the respiration rate was varied from 10 bpm to 20 bpm. It was observed that at a RR of more than 18 bpm, the stepper motor sometimes failed to deliver the required torque. Moreover, a large amount of displacement was observed in the 3D printed parts under compression, which led to under compression of the AMBU bag. The failure to deliver required was attributed to the lowering of motor torque at higher speeds. As the R.R. was increased keeping the T.V. constant, motor speed increased leading to a decrease in torque.



**Fig -7:** Second Working Prototype of RC Device [Courtesy Gyrodrive Machineries (P) Ltd.]

In the second RC Device prototype [Fig. 7] all the 3D printed parts were replaced by polycarbonate and aluminium to impart higher flexural rigidity. Moreover, the normal distance between the BMV bag- pressure plate point of contact and lead nut was reduced.

Furthermore, a contour plot was generated using MATLAB software [6] to find the feasible region of operation in the R.R. - T.V. space as shown in Fig. 8. This was imperative since the motor torque is inversely proportional to speed. As we go on increasing any of the parameters keeping the other fixed in the R.R. - T.V. space, the motor speed increases, subsequently decreasing the torque. For driving the second prototype a 24-Watt stepper motor was selected having a maximum design torque of 4.2 kg-cm at 2 Ampere current drawn. The shaded area in Fig 8 depicts the feasible region of operation, where the limiting torque of 0.34 kg-cm was chosen based on the following calculations:

The maximum gas pressure inside the AMBU bag is

$$P_{Ambu} = 40 \text{ kgcm} = 3.922 \text{ kPa}$$

This pressure is seen by the compression plates leading to a thrust force calculated using the following equation,

$$Thrust = P_{Ambu} * Area = 19.61 \text{ N}$$

For providing this thrust force, the lead screw motor torque was calculated using the following equations,

$$T = 10.19 * Thrust * \frac{d_m (\mu \pi d_m + L)}{2 (\pi d_m - \mu L)} = 0.3 \text{ kgcm}$$

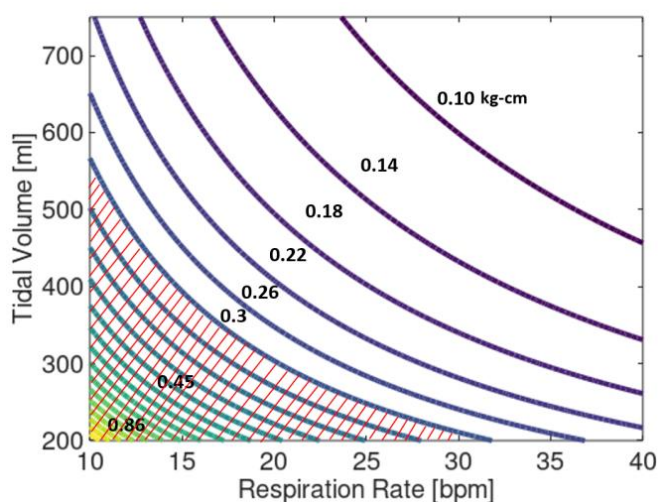


Fig -8: Contour Plot for Stepper Motor used [Courtesy Gyrodrive Machineries (P) Ltd.]

Hence, the minimum torque output of the motor should not fall below this value in any respiration setting. For the second prototype, as can be inferred from the figure, the motor works adequately with the R.R. - T.V. settings within the hatched region. Beyond this region, the motor slips as it fails to provide the required torque for sustaining the thrust.

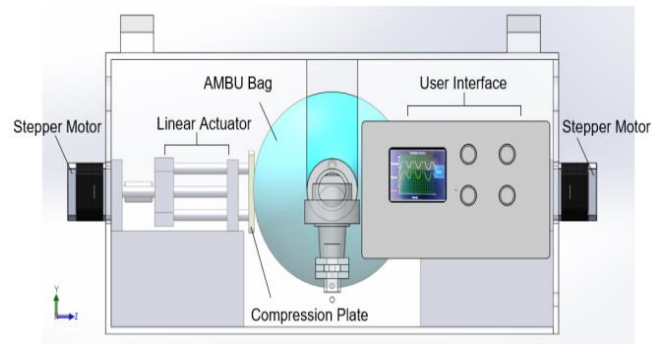


Fig -9: Third Working Prototype of RC Device

A third prototype was developed with improvements made in the software, user interface and actuator hardware. As it can be inferred from Fig. 9, the actuator position was changed to the exact centre of the AMBU bag. This was done to render the design more compact as well as reduce the actuator loading. A larger touch screen was incorporated with lung mechanics display features. This was done to facilitate the clinician to observe and interpret features like plateau pressure, PEEP, Et-CO2, etc., which can reveal important information pertaining the lung physiology. A PEEP device was incorporated as a provision for recruitment maneuvers. Here a maximum setting of 40 cm H2O was provided to avert the risk of a decrease in venous return. A 2 cm H2O of PEEP gradation was provided to offer gradual lung recruitment and avoid the risk of hemodynamic perturbation.

### 3.Results & Discussion

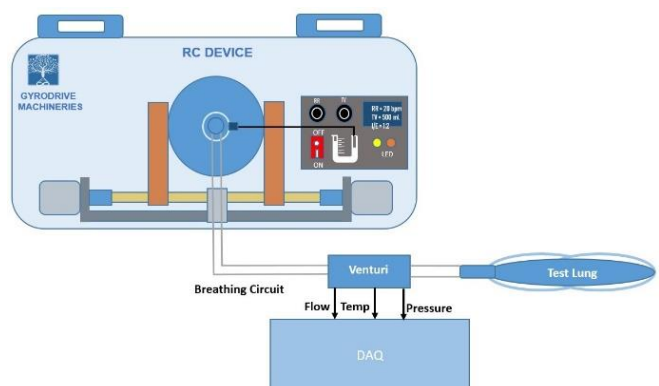
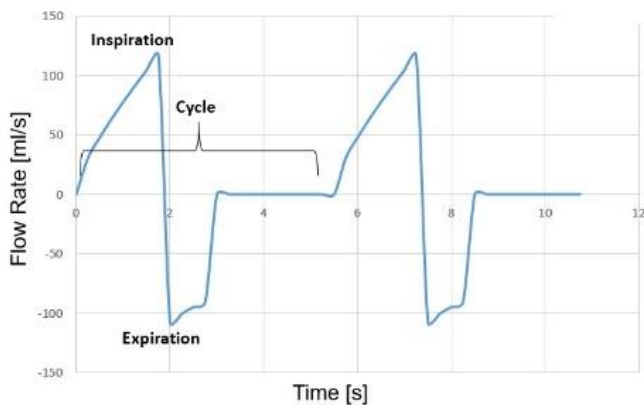


Fig -10: Test Set-Up for RC Device [Courtesy Gyrodrive Machineries (P) Ltd.]

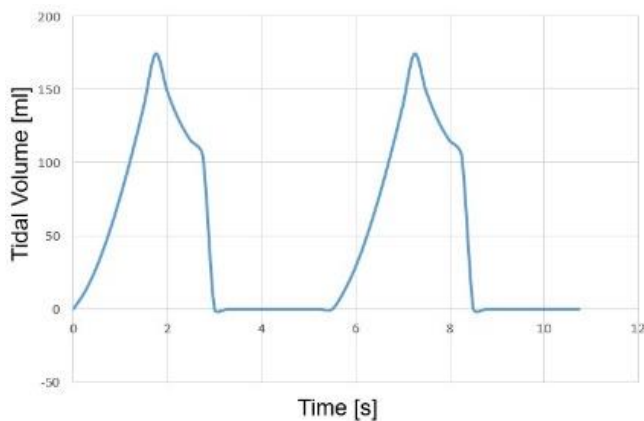
For testing the ventilator performance, a test set up as shown in Fig. 10 was developed. A flexible breathing tube

was attached to the distal end of the self-inflating bag connected to a 1400 ml test lung via a venture type flow meter. The test lung compliance was 50 ml/cmH<sub>2</sub>O whereas total resistance of 6 cmH<sub>2</sub>O/l/s was observed in the complete breathing circuit. Pressure, Flow Rate and Temperature were recorded using a HanTek-6000 Desktop Oscilloscope at a sampling rate of 1 kS/s per channel.

It can be inferred from Fig. 11 that a typical step function like flow rate profile during inspiration and an exponentially decaying expiratory flow rate is not observed [7]. This can be attributed to the non-linear characteristics of an AMBU bag when used as a pump. Fig. 12, Fig. 13 and Fig. 14 further aid in highlighting this observation. To have better control over the pressure and flow rate characteristics of the RC Device, several iterations with different compression plate designs and compression rates should be conducted. In the initial set up the compression action was a step function with constant plunger speed. The response of the actuated AMBU bag to different compression speed profiles like ramp etc. have to be tested. Moreover, the contact mechanics, interaction of the compression plate with the AMBU bag has to be modeled for effective control of device output.

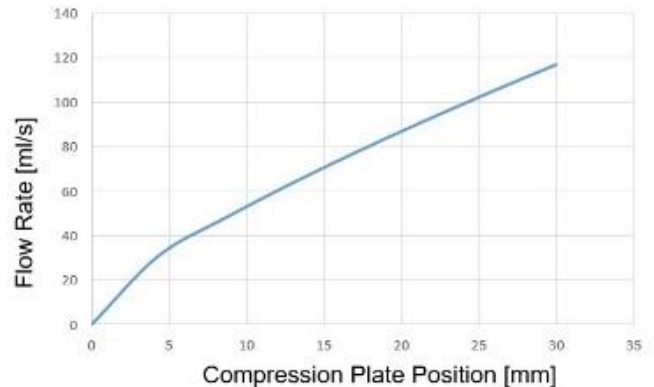


**Fig -11:** Plot of Air Flow Rate with Time for Two Breathing Cycles  
[Courtesy Gyrodrive Machinerics (P) Ltd.]



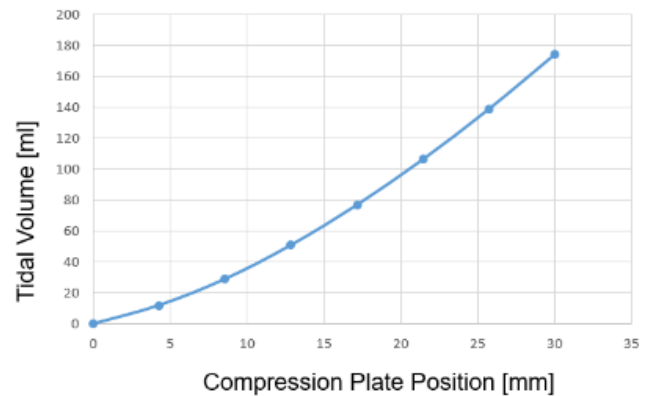
**Fig -12:** Plot for Tidal Volume with Time generated by Integration Flow Rate

[Courtesy Gyrodrive Machinerics (P) Ltd.]



**Fig -13:** Plot of Air Flow Rate with Compression Plate Position

[Courtesy Gyrodrive Machinerics (P) Ltd.]



**Fig -14:** Plot of Delivered Tidal Volume with Compression Plate Position

[Courtesy Gyrodrive Machinerics (P) Ltd.]

#### 4. Conclusion

A low cost automated AMBU bag ventilator was designed in a low resource setting to serve as a bridge between manual ventilation and hospital ventilation. To achieve the desired objective of keeping the cost low, more than 90% of the device parts were indigenized. In the design process, three hardware prototypes with gradually increasing functionality were made and tested. A device patent for RC Device was filed and has been published [8].

An experimental study on the compression flow characteristics of an AMBU bag were conducted. Different flow rate meters and pressure transducers were simulated and tested. The device was also tested continuously for 48 hours and performed as per specifications.

#### 5.Future Scope

Although the relationship between the actuator feed and displaced volume can be calibrated, the contact mechanics

between the pressure plate and the BVM must be established. Moreover, different functions other than step function feed need to be investigated to optimize the performance of the device.

## ACKNOWLEDGEMENT

The design of this device was a collaborative effort by PGIMER Chandigarh and Gyrodrive Machineries Private Limited, Pune Design Bureau. The authors would like to thank Venture Centre Pune for providing the CAD software SolidWorks and MATLAB software for this work.

**Conflict of Interest:** There are no conflicts of interest pertaining to this collaborative research work

## REFERENCES

- [1] R. Chauhan, V. Chaudari, A. Gaddamwar and E. Dhar, "Mathematical Modelling of an Automatic Bag Mask Valve Emergency Ventilator," vol. 07, no. 09, 2020.
- [2] A. M. A. Hussein, H. J. Lee, J. Negrete, S. Powelson, A. Servi, A. Slocum and J. Saukkonen, "Design and Prototyping of a Low-cost Portable Mechanical," in Proceedings of the 2010 Design of Medical Devices Conference, Minneapolis, 2010.
- [3] P. S. Coffey, E. A. Saxon, I. Narayanan and R. M. DiBlasi, "Performance and Acceptability of Two Self-Inflating Bag-Mask Neonatal Resuscitator Design," vol. 60, no. 09, 2015.
- [4] C. Kerechanin, P. Cutchis, J. A. Vincent, D. Smith and D. S. Wenstrand, "Development of Field Portable Ventilator Systems for Domestic and Military Emergency Medical Response," 2004.
- [5] "Rapidly Manufactured Ventilator (RMVS)," Medicines & Healthcare products Regulatory Agency, 25 March 2020. [Online]. Available: [https://assets.publishing.service.gov.uk/government/uploads/system/uploads/attachment\\_data/file/879382/RMVS001\\_v4.pdf](https://assets.publishing.service.gov.uk/government/uploads/system/uploads/attachment_data/file/879382/RMVS001_v4.pdf). [Accessed 07 April 2020].
- [6] R. Pratap, Getting Started with MATLAB: A Quick Introduction for Scientists & Engineers, Oxford University Press, 2013.
- [7] R. Chauhan, V. Chaudhari, A. Gaddamwar and E. Dhar, "Mathematical Modelling of an Automatic Bag Mask Valve Emergency," vol. 07, no. 09, 2020.
- [8] R. Chauhan, "Artificial Manual Breathing Unit Bag Operation Device". India Patent 201911053340A, 20 March 2020.
- [9] R. L. Chatburn, "Engineering Principles Applied to Mechanical Ventilation," in Annual International Conference of the IEEE Engineering in Medicine and Biology, 2003.

## BIOGRAPHIES



**Dr. Rajeev Chauhan**  
Assistant Professor, PGIMER  
Chandigarh, India  
MD Neuro-Anesthesia, PGIMER

**Nidhi Chauhan**  
Assistant Professor,  
Department of Psychiatry GMCH-32,  
Chandigarh, Punjab, India

**Rashi Sarna**  
Assistant Professor,  
Department of Anesthesia and Intensive Care  
PGIMER  
Chandigarh, Punjab, India

**Raman Sharma**  
Assistant Professor,  
Department of Hospital Administration PGIMER  
Chandigarh, Punjab, India



**Kalpak Kawadgave**  
B. Tech Mechanical Final Year  
Vishwakarma Institute of  
Information Technology, Pune



**Akash Gaddamwar**  
Director Gyrodrive Machineries (p) Ltd. India  
RA Mechanical IISc Bangalore  
RA ICER IISc Bangalore



**Eshan Dhar**  
Director and CTO, GMPL India  
RA Sandia Lab USA  
ME Mechanical IISc Bangalore  
PG Diploma Nuclear BARC  
Ex-Scientific Officer-C  
Department of Atomic Energy  
India