



Envisioning Architecture

SPACE / TIME / MEANING

ENVISIONING ARCHITECTURE: SPACE / TIME / MEANING

The Proceedings of the 13th Biennial International Conference
of the European Architectural Envisioning Association
at the Glasgow School of Art, 2017

Edited by
Tom Maver, Paul Chapman, Christopher Platt,
Victor Portela and David Eaton

Cover Design by David Eaton (image by Olga Tarasova)

Published by the Mackintosh School of Architecture
and the School of Simulation and Visualization at
the Glasgow School of Art

Typeset by Freight Design (www.freightdesign.co.uk)

ISBN: 978-0-9576660-8-5

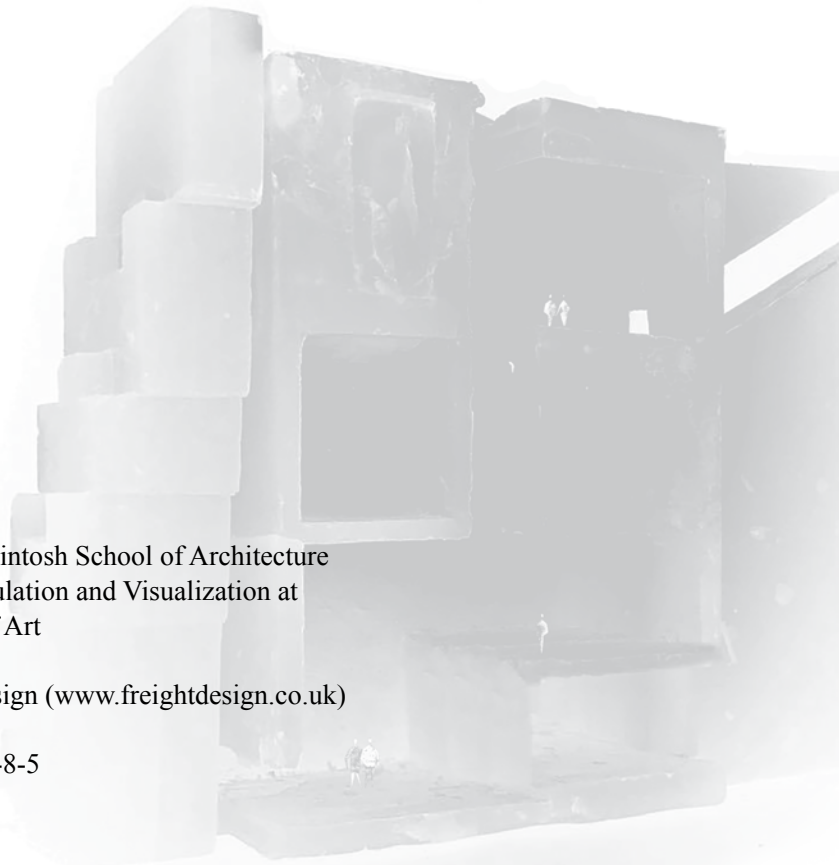

Contents

Preface.....	1
Keynote Speakers	
<i>Marcos Novak</i>	3
<i>Lorraine Farrelly</i>	5
<i>Daniel Pletinckx</i>	7
Sunlight, Eucalypts, and a Golden Bat: Hardy Wilson and the Antipodean Capriccio	9
<i>Yvette Putra</i>	
Community space spatial layout transition in typical Japanese nursing home	18
<i>Lin Bai, Satoshi Nasu</i>	
Sharing Sketches: Architectural Outreach Projects with Elementary Students	24
<i>Margaret McManus</i>	
Tracing the Past: Establishing Tolerances when Investigating Medieval Vault Rib Geometries using Digital Tools	30
<i>Nicholas Webb, Alexandrina Buchanan</i>	
Spatial-Visual (New) Indeterminacy in the Architectural Threshold	38
<i>Amos Bar-Eli</i>	
Analysis of Algorithmic Design Process – Case Study of Agricultural City Project by Kisho Kurokawa	46
<i>Maki Kasahara, Akihiro Mizutani, Kiwa Matsushita</i>	
Visual Communication in Architecture – When an Image Becomes Reality	54
<i>Antonio Nevescanin</i>	
Aero-Architecture “Visualizing to 2nd life of Commercial Airliners” – Recommissioning, Reclaiming, Redesigning Commercial Airliners into Resilient Spaces	65
<i>Harry A. Eggink RA</i>	
Embedded Things – an Inquiry into Beauty	73
<i>Zuzanna Karczewska</i>	
The Intention behind the Spatial Representation of F.L. Wright’s Wasmuth Portfolio	80
<i>Kiwa Matsushita, Hiroshi Tsumita</i>	

Site-Sense	88
<i>Joanna Crotch, Isabel Deakin</i>	
Detour as Destination: An Architecture of Wandering	96
<i>Meliti Dikeos, Lora Kim, Ingrid Strong</i>	
Augmented Maquette for Urban Design	104
<i>Barbara E. A. Piga, Valentina Petri</i>	
Visualization Principles for the Beginning Design Studio	114
<i>Mark O’Bryan</i>	
“Making Sense” – Meaning, Representation and Visualization in the Spaces of Cross–,Trans– and Interdisciplinarity	121
<i>Joern Langhorst</i>	
Interpretation, metaphor, and constraint as vehicles for communicating space, time, and meaning	132
<i>Lohren Deeg, Sean Burns</i>	
Building Posture: Glasgow School of Art’s Driven Voids of Light and Body Dynamics	138
<i>Ahmed K. Ali</i>	
A Form-Function-Use (FFU) model to simulate human behavior in built environments	146
<i>Davide Schaumann, Yehuda E. Kalay, Seung Wan Hong</i>	
Taking a Hard Line: The Revealing Power of Functional Draughtsmanship	154
<i>Christopher Platt</i>	
Enhancing design representational environment to support design learning in the studios	163
<i>Julie Milovanovic, Daniel Siret, Guillaume Moreau, Francis Miguet</i>	
Study of psychological evaluation and its relation to intervals “MAAI” in the external spatial composition of architecture	171
<i>Masaru Harigai, Hiroshi Tsumita, Kazeno Tajika</i>	
Blurring the Boundaries: Visual Design Language, Product Design, and Fabrication in an Architecture Course	178
<i>Saleh Uddin</i>	
Filmmaking, a method for teaching urban design: Narrative, plot, characters, and action for urban spaces	188
<i>Michel Mounayar RA</i>	
Designing Socio-spatial Infrastructures with Time in Mind: Reimagining Istanbul Sali Pazari	196
<i>Antonio Boeri, Burak Pak</i>	
Integrated Space: The Novel Design Research Experience	203
<i>Diana Nicholas, Shivanthi Anandan</i>	

Understanding the meaning of architectural-urban heritage – review of approaches and methodologies?	210
<i>Mateusz Pankiewicz</i>	
A step in the past, a look into the future: the poetic of black and white to decode Italian rationalist architecture	218
<i>Paolo Sanza</i>	
360° vision, from panoramas to VR	226
<i>Lescop Laurent</i>	
Creative Disruptions: Design Activity or Activism?	234
<i>Zamila Karimi, Saleh Uddin</i>	
Sharing the experience of urban design schemes through immersive simulation	244
<i>Barbara E.A. Piga, Eugenio Morello, Marco Boffi, Nicola Rainisio, Giovanni di Liberto</i>	
Form and Visualisation: Development, Implementation and Evaluation of an Integral, Foundational Imaging Study Program	252
<i>Jack Breen</i>	
Architecture as Petrified Music – a Tectonic Definition	260
<i>Filipe X. Oliveira</i>	
Cinematic approaches to mapping spatial narratives	269
<i>Saul Golden</i>	
The Significance of Retaining Post-Military Barrack Complexes for the Sustainable Landscapes of Garrison Towns	277
<i>Marta Rudnicka-Bogusz</i>	
The Virtual / Physical Equilibrium	288
<i>Martijn Stellingwerff</i>	
Interpreting Visualisations	295
<i>Cameron Purdie</i>	
Oppressed Bodies and Embodied Repressions – Mandatory Hijab and Facades in Contemporary Iran	302
<i>Ehsan Sheikhotharam</i>	
Toward Time-Like Oriented Approaches in Architectural Education	310
<i>Negar Kalantar</i>	
Persuasive Sway of Rendering Media	315
<i>Amy Huber</i>	
From Above the City	325
<i>Derin İnan</i>	

Understanding and Developing Meaning in Design:	
Abstraction and Meaning	333
<i>Thomas M. Lesko</i>	
The Right Bike at The Right Time: a brand new (old) interface for VR	339
<i>Michael Knight, Wolfgang Dokonal</i>	
Attuning to Cultural Significance	347
<i>Salim Elwazani</i>	
Narrative facades of Grainger Street: Design and manufacturing of a physical model for participatory design	355
<i>Danilo Di Mascio, Ruth Dalton</i>	
Four-Dimensional Nature of Urban Structures – Reflections upon Company Towns	363
<i>Bartosz Walczak</i>	
(Re)creation of the Socio-Spatial Identity of a Postindustrial City	371
<i>Anetta Kepczynska-Walczak</i>	
Index of Authors	381

Preface

I first became aware of the activities of the European Architectural Envisioning Association (EAEA) when invited to be a Keynote Speaker at the 12th biennial conference hosted at the Lodz University of Technology in Poland and organized by Anetta Kepczynska-Walczak; this most enjoyable conference had the theme Image, Perception and Communication of Heritage and resulted in an excellent Monograph (ISBN 978-83-7283-681-6).

EAEA had started out as the European Architectural Endoscopy Association with the early conferences in Tampere (1993), Vienna, Delft, Dresden and Essen. As the endoscopy technology was overtaken by digital technology, the association changed its name and broadened its appeal. It now is the premier association for academic papers that envision architecture. Subsequent conferences in Bratislava, Dortmund, Moscow, Cottbus, Delft (again), Milano and of course Lodz. I recommend that you go to the EAEA website to learn more (<http://eaeenet.wixsite.com/eaea>).

It is difficult for me to shake off the impression that my invitation to present a Keynote paper in Lodz was a thinly disguised opportunity to persuade me to host the 2017 conference at the Glasgow School of Art. Had I known the effort, frustration and time, I might have fought off my thoughtless impulse to say yes. So here we are!

The Monograph edited from the 2015 conference is very special. Here, however, we have had a more modest intent – simply to provide a clear and full account of the 46 papers that were selected and presented. The intention was to be inclusive rather than elitist, diverse rather than definitive, open rather than closed. Just what we need?

Lots of folk in the international community helped to bring this event together. Those on the Review Group include Aleksander Asanowicz, Jack Breen, Laurent Lescop, Bob Martens, Saleh Uddin, Eugene Morello, Barbara Piga, Murat Sahin, Daniel Siret, Matyn Stellingwerff, Barosz Walczek, Johnny Rodger, Branka Demitrijvic, Jelena Petric, Johan Verbeke, Emine Thompson, Sally Stewart, Florian Urban, Henri Achten, Andre Brown, Danilo DiMascio, Joachim Kierferle, Wolfgang Dokonal, Jose Duarte, Rudi Stuff, David Buri, Bigi Colakoglu, Tadeja Zupanic, Brian Evans, Tim Sharpe, Jo Crotch, Sandy Louchart, Ambrose Gillick, Colin Porteous and Robert Mantho.

Special thanks are due to Anetta Kepczynska-Walczak, the editor of the 2015 Monograph. She unstintingly gave a huge amount of help to me regarding all aspects of this 2017 event.

Tom Maver

Keynote Speaker: Marcos Novak

Marcos Novak is an architect, artist, composer, and theorist who employ algorithmic techniques to design actual, virtual and hybrid intelligent environments. The self-described trans-architect is seeking to expand the definition of architecture by including electronic space, and originated the concept of liquid architectures in cyberspace and the study of a dematerialized architecture for the new, virtual public domain, the immersive virtual worlds.



Marcos is also a professor at the Department of Architecture and Urban Design at UCLA, he is the founding director of the Laboratory for Immersive Virtual Environments and the Advanced Design Research Program at the School of Architecture at the University of Texas at Austin, and a Fellow of the World Technology Network; and his (many) writings which combine architecture, music, art, computation, science, and/or technology include the seminal paper *Liquid Architectures in Cyberspace* (1991), *transArchitecture: Against the Collapsing Radius of Fiction*, and *Transmitting Architecture: The transPhysical City* (1996).

Keynote

“Envisioning architecture” can be understood in many ways: envisioning the form, performance, and impact of architecture; envisioning the near and far; the past, present, and future; the small and large; contexts and circumstances; absolutes and alternatives; causes and consequences. But there is more.

More abstractly, we can think of envisioning as it pertains to:

- a. The extended architectural object that is envisioned;
- b. The qualities emanating from that envisioned object, both actual and imagined;
- c. The self-reflexive possibility that the envisioning itself becomes autonomously architectonic as both object and quality;
- d. Not the envisioned object, but the cumulative effects of the envisioned object on culture;
- e. The re-envisioning of Architecture itself as an act of envisioning and actualizing culture itself.

In other words, the span of envisioning covers a continuum ranging from the literal and pragmatic to the philosophical and civilizational.

For decades, technological advances have been altering how we envision architectural propositions. Now, the envisioning of architecture is undergoing yet another wave of major transformations, perhaps the greatest one so far. These transformations are mediated through technologies, but eventually raise questions about what Architecture itself stands for, not only as profession, but as an ancient and vital discipline and major human endeavour.

Keynote Speaker: Lorraine Farrelly

Lorraine Farrelly qualified as an architect in 1999. She worked professionally as architect and interior designer in London and in practices across Hampshire. Her research interests include a multi-disciplinary approach to architecture at various scales, through understanding ideas of interior detail to urban concepts. She has run degree and Masters in Architecture courses and led the Masters in Architecture at the University of Portsmouth. She has written undergraduate and housing proposals for European sites and competitions in Dublin, Paris, Amsterdam, Vienna, Venice, Rotterdam, London, Dublin and also on regional sites in the UK considering new town and regeneration projects.



She has written books across a range of subjects from Representation and Drawing, Urban investigation and analysis to Materials and Interior space. I work with the RIBA to regularly Chair validation of Schools of Architecture in the UK and internationally. Lorraine is external examiner at Schools across the UK, currently external examiner at Robert Gordon University and Bath University.

Lorraine Farrelly is head of the new School of Architecture at the University of Reading, she has worked professionally as architect and interior designer in London and in practices across Hampshire. Her research interests include a multi-disciplinary approach to architecture at various scales, through understanding ideas of interior detail to urban concepts. She has developed and run degree and Masters in Architecture and interior design and led the Masters in Architecture at the University of Portsmouth. The New School of Architecture is developing a research informed curricula with a strong connection to contemporary practices in architecture. She has written books across a range of subjects from Representation and Drawing, Urban investigation and analysis to Materials and Interior space. She works with the RIBA to regularly Chair validation of Schools of Architecture in the UK and internationally. Lorraine is external examiner at Schools across the UK, currently external examiner at DIT in Dublin and Bath University.

Keynote

The continuing importance of analogue representation in architecture and its relationship to cognitive thinking and the design process.

The representation of the idea for architects is central to describing our process of thinking around architecture. The idea is fluid, dynamic and evolving, the freehand drawing is still an authority in the description of this process. As the digital world becomes ever more realistic, it is the sketch as a drawing and model that has real authenticity.

There are many advantages of the freehand process-

Representing the urban scale to the interior scale of architecture and space which can be accommodated quickly though the freehand process, the individuality of the drawing style, the accessibility of the image and the range of media that can be expressed from collage to storyboard, to cinematic narrative. The range of expression of drawing will be considered and are examination of the importance of the freehand in the ever digital world of expression.

Keynote Speaker: Daniel Pletinckx

Daniel Pletinckx was trained as a civil engineer, with specialisation in information technology. He gained extensive experience in system design, quality assurance, digital image processing and synthesis, 3D and virtual reality through a career of 15 years in private industry.

Currently, Daniel Pletinckx is director of Visual Dimension bvba, a SME dealing with architecture and ICT based innovation in cultural heritage, urbanism and tourism. Visual Dimension specialises in new, efficient ways for creation of and interaction with 3D buildings, landscapes and objects. The company has been active in European projects, such as the European Network of Excellence V-MusT.net that focuses on virtual and digital museums, and 3D-ICONS that provided 3D content of World Heritage monuments and sites through <http://www.europeana.eu/portal/en>. It also has created and interactive landscape visualisations and educational resources for green energy projects.

See some 3D reconstructions of historical buildings, landscapes and objects by Visual Dimension at <https://enameabbey.wordpress.com>.



Keynote

Why do architects still work with physical models, while digital 3D models are way more flexible and cheaper and can be viewed from all relevant points of view? One of the major reasons is that they want to be able to discuss the architectural design with colleagues, with subcontractors and customers. So making 3D accessible for discussion and design to a group of people is crucial in the take-up of this technology and its integration within the daily workflow of architects. When selling the project, in most cases, the customers need to be addressed as a group that can see, experience and explore the architectural space that has been created. This holds also for many sectors and applications outside architecture, in which 3D has a distinctive added value, such as cultural heritage, training, education, tourism or medicine. In this keynote presentation, we show several down-to-earth implementations of GroupVR that are instrumental in bringing back the social dimension of VR and help to integrate virtual and augmented reality in the daily workflow of architecture and other sectors.

Sunlight, Eucalypts, and a Golden Bat: Hardy Wilson and the Antipodean *Capriccio*

Introduction

The word *capriccio* is derived from the Italian, where it describes a “sudden start” or “motion”¹. In artistic and architectural contexts, a *capriccio* may be defined as “a type of landscape or cityscape that is more fancifully rendered than the more topographically correct *veduta*”². Meanwhile, David Mayernik writes that:

Since the eighteenth century the *capriccio* in the arts has meant either a brief, sprightly musical composition, or an image composed of disparate architectural elements, often archaeological³.

For architects, a *capriccio* calls to mind a drawing whose composition oscillates freely between the real and unreal realms. Thus, its edifices may be formed of familiar materials and follow natural laws, but its entourage is a largely improbable concatenation. The overall effect of architectural *capricci* is charming, disarming, and intellectually stimulating. Ultimately, architectural *capricci* challenge their viewers’ understanding of the corporeal and temporal aspects of architecture.

The most well-known architectural *capricci* are those from eighteenth- and nineteenth-century Europe, which include the drawings by Giovanni Batista Piranesi (1720-1778) and Joseph Gandy (1771-1843). However, given the definition of *capricci*, as described earlier, it is conceivable that this genre of drawing existed centuries earlier. It may be seen in, for example, the depictions of architecture in mediaeval allegorical art. Likewise, architectural *capricci* continue to be produced into the twenty-first century, and find their expression in the computer-generated imagery which saturates schools and practices of architecture. In this way, the

¹ This is, in turn derived from the Italian *capra*, meaning “goat”. Oxford English Dictionary. <http://www.oed.com> (accessed 31.03.2017).

² Palmer, Allison Lee. *Historical Dictionary of Neoclassical Art and Architecture*. Lanham [Maryland]: Scarecrow. 2011. p. 57. Interestingly, in the same publication, *capriccio* and *veduta di fantasia* are proposed as being synonymous. Palmer. *Historical Dictionary of Neoclassical Art and Architecture*. p. 196.

³ Mayernik, David. “Meaning and Purpose of the *Capriccio*” in Steil, Lucien (ed.) *The Architectural Capriccio: Memory, Fantasy and Invention*. Surrey - Burlington [Vermont]: Ashgate. 2014. p. 5.

possibilities for what constitute architectural *capricci* are more open to interpretation, and investigation, than may be initially thought.

As it is understood that architectural *capricci* are not confined by the time or place of their production, this paper proposes, as examples of architectural *capricci*, drawings by the Australian architect William Hardy Wilson (1881-1955). On the one hand, Wilson's drawings underscore the wide applications of architectural *capricci*, but they also invite investigation into their relationship to their particular context. Thus, this paper probes, through analyses of his drawings, the role of architectural *capricci* in Australia during the first decades of the twentieth century. Inversely, this paper considers how early twentieth-century Australia influenced architectural *capricci*, while bearing in mind their historical European origins.

William Hardy Wilson

William Hardy Wilson's biographies reveal an individual who was widely travelled, deeply philosophical, and given to romantic ideations. Moreover, his interests were various and sometimes unusual, to include Confucian thought, furniture design, ornithology, and watercolour painting. In terms of his architectural preferences, he was apart from his contemporaries, as he rejected the Modernist aesthetic of his day. Instead, he looked to historical, and, often, foreign, architectural styles, for inspiration.

Wilson wrote extensively, usually expressing himself in whimsical prose. The corpus of his writings includes contributions to journals and newspapers, commentaries on architecture and his travels, and even fiction. Some of his publications include his elaborately rendered drawings, and some of his drawings were also exhibited, both during and after his lifetime. Despite the number and diversity of his drawn and written works, they had a limited distribution, and, are currently, generally unfamiliar to the public. Yet, all in all, his reputation as an artist equals, if not exceeds, that as a writer, or, indeed, an architect.

This paper considers three groups of Wilson's drawings, namely those from two publications, *Old Colonial Architecture in New South Wales and Tasmania* (1924) and *Grecian and Chinese Architecture* (1937), as well as an exhibition, *Kurrajong: Sit-Look-See* (1950). Each of these groups represents a definitive moment in his ever-developing philosophy, with the idealised compositions in *Old Colonial Architecture* showing his early preference for Australia's Georgian architecture. Meanwhile, his drawings in *Grecian and Chinese Architecture*, which were drawn in situ and in the tradition of the Grand Tour, demonstrate his interest in foreign architectural sources. The *Kurrajong* drawings, made towards the end of his life, are a synthesis of his former ideas, as they communicate his vision for a hybrid of Eastern and Western architecture.

In Wilson's architectural *capricci*, notions of time and place are upset, by, firstly, the privileging of imagined views over accurate records, as in his drawings in *Old Colonial Architecture*. Secondly, in seeking to unite historical Eastern and Western architectural styles in an Australian landscape, he created images whose time and place resist definition. This is demonstrated by his drawings for *Kurrajong*, whose projections for the future draw on the past, and whose architectural sources are

confused.

Through Australia's colonial link, Wilson's architectural *capricci* were influenced by eighteenth- and nineteenth-century European precedents, and are, in fact, a continuation of these precedents⁴. However, his contribution to the genre of architectural *capricci* is unique, as his predilection for narrative and the polemical are manifested in his drawings.

Sunlight and Eucalypts

The drawings in *Old Colonial Architecture* are of buildings in New South Wales and Tasmania, which, according to Wilson, date from the late eighteenth and early nineteenth centuries⁵. The term "Old Colonial"⁶ is also his own, which he describes as "an architecture of sunlight and shadows, buildings and trees"⁷. These drawings depict the buildings in their colonial context, and, being highly idealised views, are not convincing records⁸. For example, the human figures are dressed in believable styles, and behave in an almost realistic manner, but their deportment and placement are somewhat stilted.

Wilson prepared the drawings for *Old Colonial Architecture* from 1912 to 1922, and, around the time of its publication, in 1924, travelled to China, Italy, and Greece, to draw the buildings there (these drawings would later be published, in 1937, in *Grecian and Chinese Architecture*). Indeed, the introduction to *Old Colonial Architecture* was written while he was in Athens, which influenced his rumination on the past, and future, of Australian architecture:

And even as these [eucalyptus] trees, perfuming the Athenian air, have crossed the world to the feet of the Parthenon, the source whence sprang the Old Colonial Australia, so perchance, one day, shall return to thy bosom, Mother of Architecture! a new style, fruit of the union of the children of thy womb with the oriental soil in which they are, in thy eyes, but lately planted⁹.

The drawing of Lady Franklin's Museum, Hobart (Fig. 01), in *Old Colonial*

⁴ "I know his [Piranesi's] work intimately and admire it." Wilson, Hardy. *Grecian and Chinese Architecture*. Melbourne: Hardy Wilson. 1937. p. 6.

⁵ "They were built, approximately, between the years 1790 and 1850, during the first fifty years of architecture in Australia...Owing to the remoteness of the two Colonies from the scene of changing fashions, the late-Eighteenth Century style was continued well into the Nineteenth Century". Wilson, Hardy. *Old Colonial Architecture in New South Wales and Tasmania*. Sydney: Ure Smith in association with the National Trust of Australia (N.S.W.). 1975 [1924]. p. 4.

⁶ "[T]he name of 'Old Colonial' is not a correct architectural term [but] appears to me, to be more appropriate, and more easily apprehended, than the more accurate one of 'late-Georgian'." Wilson. *Old Colonial Architecture*. p. 3.

⁷ Wilson. *Old Colonial Architecture*. p. 6.

⁸ "I began with the intention of making an architectural record, but the work had not progressed far when the pictorial beauty of the subjects proved irresistible, and I looked at the buildings with a painter's eye as much as with an architects'." Wilson. *Old Colonial Architecture*. p. 2.

⁹ Wilson. *Old Colonial Architecture*. p. 10.

Architecture, is remarkable as an architectural *capriccio*¹⁰. In this drawing, Wilson used perspective in an extreme manner, to enable the front façade of this building to receive the most attention, with its Classical elements closest to the viewer. Meanwhile, the only other façade which is visible, that to the right of the viewer, is angled away sharply, so to have less clarity and room for detail. It is also possible that he was, whether consciously or otherwise, borrowing from the oblique view gained of the Parthenon in Athens, as it is approached via the Panathenaic Way¹¹.



Fig. 01. Wilson. "Lady Franklin Museum, near Hobart, Tasmania". 1915.

Source: National Library of Australia (NLA)
nla.obj-134444830.



Fig. 02. Wilson. "The Parthenon at Athens" c. 1925.

Source: National Library of Australia (NLA)
nla.obj-153528683.

Grecian and Chinese Architecture includes several drawings of the buildings in the Acropolis, which Wilson had drawn in situ. Coupled with his architectural education, this increases the likelihood that he was aware of the Parthenon's oblique approach, and emulated this, as much as some of its other aspects, when drawing Lady Franklin's Museum. His depiction of the "Peristyle of the Parthenon at Athens" (Fig. 02), from *Grecian and Chinese Architecture*, also bears some resemblance as an architectural *capriccio*, as it includes imagined birds among the Classical ruins. He wrote of his intentions to "provide life in the foreground" of this drawing:

This lovely building wanted a more noble bird... A Grecian figure would have been a wrong note beside his ruined temple, and a modern person equally

¹⁰ Built in 1842, Lady Franklin's Museum has an intriguing history, which, in addition to its appearance, lends itself well as the subject of an architectural *capriccio*. It was, legendarily, conceived as a museum for storing apples. In *Old Colonial Architecture*, Wilson provided an imaginary exchange between Lady Franklin and the unidentified architect of the museum. Wilson. *Old Colonial Architecture*. p. 8.

¹¹ "[H]ow thy [the Parthenon's] sight recalls that Temple in a fair Tasmanian valley, mute tribute to thy imperishable beauty". Wilson. *Old Colonial Architecture*. p. 10.

out of place. Then in a moment of enthusiasm phoenixes were drawn. They might be called architectural birds¹².

Among the ruins, in the foreground of the drawing of Lady Franklin's Museum, are human figures. These human figures are greatly out of scale with this building as it exists in reality, being of a more appropriate scale for most of the grand Classical temples, such as the Parthenon. This technique serves to enlarge Lady Franklin's Museum. On the whole, these human figures appear more or less a part of these ruins, and are, therefore, subservient to this building.

Lady Franklin's Museum is, naturally, removed both geographically and temporally from the Parthenon, but this is not evident to the viewer, because there are signs of wear in the pediment (although these fissures are improbably symmetrical). However, most of this building remains relatively intact, including its doorway, so an admiration for this building's entire form is not compromised. All in all, Wilson upset the notion of time in this drawing, as he has strewn ruins, composed of classical clichés, in this drawing's foreground. Nevertheless, the purpose of these ruins is purely symbolic, and they are not helpful in gaining any real sense of context, or scale, of this building.

A Golden Bat

Wilson's interests in Chinese architecture, art, and philosophy began early in his career. Aside from his travels to China, his fantasy novel, *Yin-Yang* (1934), has Chinese themes. The unrealised designs for his own home, "Celestion" (c. 1924), and the tennis pavilion, built at "Eryldene", in Sydney (1927), both manifest a hybridisation of Eastern and Western architectural styles. He also adopted, as his symbol, a golden bat, which was stylised in an approximately Chinese fashion¹³. This appears on the covers of *Old Colonial Architecture*¹⁴ and *Grecian and Chinese Architecture*. In *Grecian and Chinese Architecture*, he explained its meaning:

As the bat, which is a symbol of happiness in the Far East, flies within the circle of the world, in the device on the cover of this book, so may the architecture within bring fruitful issue to the joining of the arts in the yellow of the East and the white from the West¹⁵.

Around 1950, Wilson believed that Sydney was facing an imminent overpopulation crisis, and so envisaged, as a solution, the Eastern-Western hybrid city of Kurradjong,

¹² According to Wilson, the three young birds represent "European, Chinese, and new architecture of East and West", the last of which, evidently, presaged his plans for Kurradjong. Hardy. *Grecian and Chinese Architecture*. p. 8.

¹³ In Chinese culture, the bat symbolises happiness, as, in Mandarin Chinese, the word for 'bat' is a homophone for the word for 'happiness'.

¹⁴ In *Old Colonial Architecture*, the symbol is slightly different, with the addition of two peaches. In Chinese culture, the peach symbolises immortality.

¹⁵ In *Old Colonial Architecture*, this explanation is differently worded. The original text is entirely in capital letters, so the capitalisation in this paper is approximated. Wilson. *Grecian and Chinese Architecture*. n.p.

in the Blue Mountains of New South Wales¹⁶. Some of the Kurrajong drawings were exhibited, in 1950, under the title *Kurrajong: Sit-Look-See*¹⁷. Kurrajong was never realised¹⁸, and these drawings were donated, in 1954, to the National Library of Australia (NLA), in Canberra.

The architectural *capriccio* titled ‘Kurrajong: Sit-Look-See’ (Fig. 03) is, fittingly, included under the heading “Symbolism” in the manuscript accompanying the donation of the Kurrajong drawings¹⁹. It is one of Wilson’s allegorical visions for his utopian city, and he described it as follows:

On edge of rounded foreground is seated Australian Conductor beating time with his baton to music of Kurrajong, unaware of symbols behind him. To left, aboriginal symbol of Australia, is disappearing into valley of darkness. To right, Chinese coolie, laden with baskets, is coming up slope, symbol of future. And in foreground is Asian pheasant, bred in Kurrajong, symbol of Asian penetration²⁰.

He also explained that the atomic cloud, rising in the background, is an explosion over the Monument of Atomic Hope (which is itself a “joining of Grecian and Chinese forms in Australian monument”)²¹. These most likely reflect his theory correlating “atomic force” with the “preservation of humanity”²².

The design for the Kurrajong Library (Fig. 05) is clearly borrowed from Wilson’s impression of the Temple of Heaven²³, in modern-day Beijing, China (Fig. 04) (which was published in *Grecian and Chinese Architecture*). In *Grecian and Chinese Architecture*, Wilson wrote:

The Temple of Heaven has a loveliness which is unknown in the West; there is no other building with beauty like it²⁴.

Thus, to his mind, it was the Chinese counterpart of the Parthenon, which was, as he described, “the most beautiful building in Europe.”²⁵

In Wilson’s concept for the Kurrajong Library, he left behind not only the

¹⁶ “Sydney is the largest and most parasitical city in Australia. Unless its helplessness is understood and population decreased by creating immediately Kurrajong and similar new towns, Sydney’s downfall is inevitable.” Wilson, Hardy. “Kurrajong: Sit-Look-See [manuscript for exhibition]”. 1950. n.p.

¹⁷ Wilson translated ‘Kurrajong’ as “a place to stop, look, see”. Wilson. “Kurrajong: Sit-Look-See [manuscript for exhibition]”. n.p.

¹⁸ The real-life town of Kurrajong exists in this location, and it appears that Wilson intended for his Kurrajong to supersede it.

¹⁹ The language in this manuscript is a kind of pidgin (possibly stemming from Wilson’s appreciation of Chinese philosophical writing), hence its somewhat problematic expression. Wilson, Hardy. “Kurrajong: Sit-Look-See [manuscript for donation]”. Kew [Victoria]: Hardy Wilson. 1954. p. 3.

²⁰ Wilson. “Kurrajong: Sit-Look-See [manuscript for donation]”. p. 36.

²¹ Wilson. “Kurrajong: Sit-Look-See [manuscript for exhibition]”. n.p.

²² Wilson. “Kurrajong: Sit-Look-See [manuscript for donation]”. p. 7.

²³ This building is, more accurately, the Hall for Prayer for Good Harvests, which is one of a number of structures forming the Temple of Heaven complex. However, to align with Wilson’s descriptions, this paper uses the term Temple of Heaven.

²⁴ Wilson. *Grecian and Chinese Architecture*. p. 10.

²⁵ Wilson. *Grecian and Chinese Architecture*. p. 7.



Fig. 03. Wilson. "Kurrajong: Sit-Look-See". 1950.
Source: National Library of Australia. nla.obj-134484292.



Fig. 04. Wilson. "The Temple of Heaven
at Peking". c. 1925.
Source: National Library of Australia. nla.obj-134474563.



Fig. 05. Wilson. "Kurrajong Library". c. 1951.
Source: National Library of Australia.
nla.obj-134483967.

desire for simplicity and restraint in design, but also discarded any such approach in communicating through drawing. Thus, in its unusual composition, the Kurrajong Library drawing is more successful as an architectural *capriccio*. To this end, it follows some of the rules of Chinese perspective, where the “implied viewpoint [is] above the scene.”²⁶

The entourage in the Kurrajong Library drawing presents another issue for consideration. Not only are the human figures free from Western perspectival conventions, they are, additionally, uniform in appearance, and clothed in what appear to be Chinese, or at least East Asian, costume. This, along with the lack of Western perspective, suggests that Wilson intended for an extensive Sinification of this drawing²⁷.

Wilson’s architectural *capricci* for Kurrajong show his responses to conservative cultural and political milieus, and convey his particular views on civilisation. Although he was typical in overlooking Australia’s colonial-era transgressions, he critiqued the then-current White Australia Policy²⁸, by calling for the employment of Chinese workers to realise his plans for Kurrajong²⁹.

Conclusion

Wilson’s architectural *capricci* recall a patina-encrusted past, yet, at the same time, offer glimpses of a utopian future. They depict real geometries, but are populated with imagined entourage. Thus, they test the boundaries of architecture, but never cross them.

This paper suggests that Wilson’s architectural *capricci* are, primarily, a search for an appropriate style in Australian architecture. As a concept, this search continues into the present day, and remains unresolved. Australian architecture, until recent decades, dismissed its indigenous cultures as legitimate sources, and its relationship with its colonial past is still difficult. Moreover, Australia’s geographical position, in Asia and Oceania, has put it at odds with its British heritage.

For Wilson, these conditions necessitated imaginative solutions. This paper proposes that there are successors, in Australian architecture, to his architectural *capricci*, and who operated in the late twentieth and early twenty-first century. The Melbourne-based practice of Edmond & Corrigan, for example, use architectural *capricci* in a similar manner, but, at the same time, respond to the contemporary challenges for Australian architecture, including greater diversity and pluralism.

²⁶ Fraser, Iain, and Rod Henmi, Rod. *Envisioning Architecture: An Analysis of Drawing*. New York: Van Nostrand Reinhold. 1994. p. 46.

²⁷ These figures and the streetscape were explained as having been taken from the novel *Yin-Yang*. Wilson. “Kurrajong: Sit-Look-See [manuscript for donation]”. p. 31.

²⁸ “Above all else is the necessity to contact Chinese creative thought. The Australian Parliament refused to admit a reasonable quota of Chinese creative people and admitted students and traders for a limited period of seven years. Thus we took road which leads to destruction.” Wilson. “Kurrajong: Sit-Look-See [manuscript for exhibition]”. n.p.

²⁹ “To avoid this mistake, a way is possible by creating a new city such as Kurrajong, and admitting creative Chinese to help in the task which could become an important opening in the new world.” Wilson. “Kurrajong: Sit-Look-See [manuscript for exhibition]”. n.p.

Bibliography

- Edwards, Zeny (ed.). *William Hardy Wilson: Artist, Architect, Orientalist, Visionary*. Sydney: Watermark. 2001.
- Fraser, Iain, & Henmi, Rod. *Envisioning Architecture: An Analysis of Drawing*. New York: Van Nostrand Reinhold. 1994.
- Hamann, Conrad; Van Schaik, Leon; Mitsogianni, Vivian; Callister, Winsome; Watson, Fleur. *Cities of Hope Remembered: Cities of Hope Rehearsed: Australian Architecture & Stage Design by Edmond & Corrigan 1962-2012*. Fishermans Bend [Victoria]: Thames & Hudson Australia. 2012.
- Mayernik, David. "Meaning and Purpose of the *Capriccio*" in Steil, Lucien (ed.). *The Architectural Capriccio: Memory, Fantasy and Invention*. Surrey - Burlington [Vermont]: Ashgate. 2014. p. 5-13.
- Oxford English Dictionary. <http://www.oed.com> (accessed 31.03.2017).
- Palmer, Allison Lee. *Historical Dictionary of Neoclassical Art and Architecture*. Lanham [Maryland]: Scarecrow. 2011.
- Wilson, Hardy. *Grecian and Chinese Architecture*. Melbourne: Hardy Wilson. 1937.
- Wilson, Hardy. "Kurrajong: Sit-Look-See [manuscript for exhibition]." 1950.
- Wilson, Hardy. "Kurrajong: Sit-Look-See [manuscript for donation]." Kew [Victoria]: Hardy Wilson. 1954.
- Wilson, Hardy. *Old Colonial Architecture in New South Wales and Tasmania*. Sydney: Ure Smith in association with the National Trust of Australia (NSW). 1975 [1924].

Community space spatial layout transition in typical Japanese nursing home

Introduction

Along with the development of modern Japanese economy, nursing home in Japan has also been evolved. In 1963, when the first welfare law for the elderly was issued, Japan was experiencing high economic growth, urbanization, and women's social advancement. The household functions was also under changes at that time, making it difficult for elderly to take care of themselves at home, which led to high market needs of senior facilities. Consequently, lots of large-scale nursing homes with big shared room for more than 10 residents were built up. This solved the problem of senior facility shortage, but the collective living in such a large scale care nursing home also brought residents the difficulty in receiving care service. With the improvement of living standards, slightly smaller group living type nursing home came out in 1980s. Unlike the big shared room living, a smaller group of 4~6 people sharing living room became the main style, but the nursing care was still provided collectively though the scale was a little smaller than before. Later, by the influence of realizing home alike living style and having individual care service, nursing home with private living room and unit care living space appeared in 1996. This is so-called modern unit care nursing home, and is now the main senior facility in Japan¹.

By the transition of nursing home from large scale nursing care to unit care, the common space structure has also been changed(Fig.01). In large scale care nursing home, the common space is mainly concentrated in one location, where eating, recreation, and rehabilitation etc. daily activities are taken place. On the other hand, with the changes to unit care style, the dining room and day activity are gradually separated, a living space is designed and shared by several private rooms for day activities, and further connects to place with higher publicity (Fig. 01).

Toyama investigated the effectiveness of social and care service by introducing private room and small scale care unit in Japanese nursing home², concluded that

¹ Murakami Miyuki, et al.(2003), Transition of Institutional Formation and the Principle of Nursing in Elderly Welfare, -From a Large Group Care to a Small Group Care-, Tokai University, 9, p.89-95.

² Toyama Tadashi(2002), A Study on the Introduction of Private Rooms and Small Care Units at Long-Term Care Insurance Facilities, Medical Economics Research, 11, p63-89.

it brought residents the formation of personalized space, the improvement of QOL(quality of life), ADL(activities of daily living), the social participation and abundant interpersonal relationship.

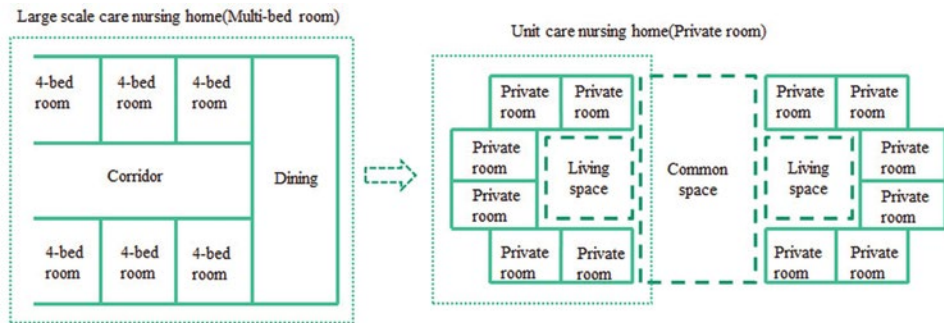

Fig. 01. Large scale care and unit care Japanese nursing home

Source: <http://www.mhlw.go.jp/topics/kaigo/kentou/15kourei/3b.html>(accessed 14.04.2017)

On the other hand, what does this transition imply to changes in community space, an important common facility for residents and local people to gather together? Figuring out this change particularly in terms of spatial characteristics would be helpful in future nursing home community space designing.

In this paper, 62 nursing homes which were built in the year from 1978 to 2014 are selected from Japanese architecture publications, with which the community space spatial characteristics is analyzed to develop an understanding of how it has been changed, and what is the inherent spatial difference between large scale care and unit care nursing homes, so as to provide a reference for future community space designing in Japanese nursing home.

Methodology

Hillier's space syntax theory and methodology is applied in this study³.The theory has been getting extensive use since it was introduced and has been generally accepted as a means in spatial characteristics comparative study from the point of view of space accessibility⁴.

The space syntax metrics of connectivity, depth, and integration are calculated to depict changes in community space spatial characteristics.

The connectivity measures the number of immediate neighbours that are directly connected to community space. The depth itself is defined as change steps from a space to others, and the step between immediate neighbours is one, so the bigger the depth of a space is, the difficult to access this space. The integration describes the average depth of a space to all others, this metric is also regarded as the index of accessibility. The higher the integration of community space is, the better it is spatially integrated in nursing home, and the easier to access and easier for people to gathering together there.

³ Hillier,B and Hanson,J(1984),The social logic of space,Cambridge Uni. Press.

⁴ Hanson,J.(1998),Decoding Homes and Houses, Cambridge: Cambridge University Press, p6-13.

Further, to conduct spatial comparison of community space to nursing home itself, the functional integration ratio, FIR, which is the ratio of integration of community space to nursing home all space average is calculated as well.

UCL DepthMap tool provides different approaches to devise and analyse spatial characteristics⁵. The convex map approach utilizes vertical boundaries to convert 3-D space to a number of “fattest” or largest 2-D convex polygons, and establishes connection for each polygon based on the availability of direct access⁶. Due to this “fat” nature of the convex shape, it is said that this approach is best suited for defining spaces such as building interiors⁷, and this approach is applied in this article for community space spatial characteristics evaluation.

Floor plan of each selected nursing home is scanned and converted to AutoCAD file, which is then imported to DepthMap tool to create convex map. Based on space functionality, each space unit is presented by using one or multiple convex maps but to have least possible number of convex maps to cover all the spaces. The wall, any kind of partition which separates spaces is taken as boundary while doors and openings are considered as connection points. For multi-story buildings, elevators and staircases are regarded as connection points.

The selection of nursing homes is evaluated in two groups based on the scale of nursing care performed, large scale care group and unit care group. The former is classic nursing home where 2~10 residents share living room while the latter is modern type where nursing care is conducted in small group unit.

Findings and Discussion

Large Scale Nursing Home

Usually the large scale nursing home was designed to have a long corridor, along which housing and service facilities were built. In some cases, it was also designed into different functional areas connected by connection corridors. A typical floor plan, convex map and spatial integration result is shown in Fig. 02. Here, the integration is coloured according to its value, high value of well integrated location to poor is presented from red, to yellow, green, and dark blue(Fig.02).

This example is a nursing home for 80 residents built in 1996. The living rooms were mainly located in 2 living areas with a long corridor connected. The community space, physical training room, dining room etc. common facilities were situated in the area slightly away from living area while service station was closely based to living area. The DepthMap calculation presents it is the long corridor which owns the highest spatial integration as red colour shown(Fig.02).

⁵ Varoudis, T(2013), Space Syntax Angular Betweenness Centrality Revisited. Proceedings of the 9th International Space Syntax Symposium, p057:7

⁶ Peponis, J. and Wineman, J.(2002), Spatial Structure of Environment and Behavior. In: R. Bechtel and A. Churchman (Ed), Handbook of environmental psychology. John Wiley and Sons, Inc. New York.

⁷ Daniel Koch, Pablo M. Carranza(2013), Syntactic Resilience, Proceedings of the Ninth International Space Syntax Symposium. p054:1

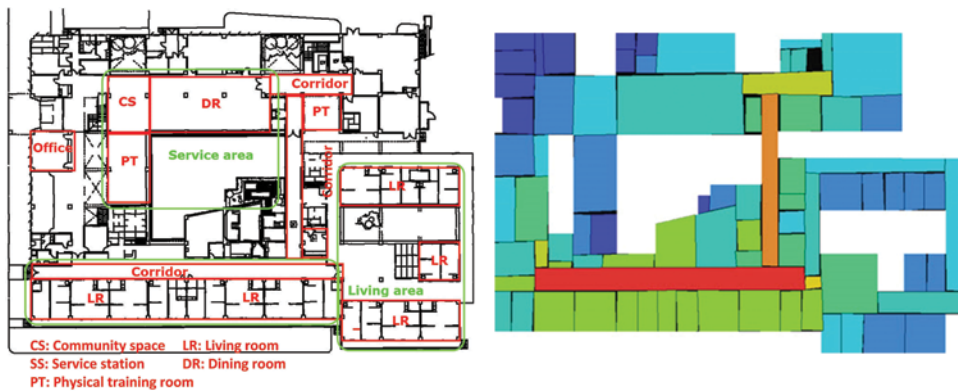

Fig. 02. Typical large scale care nursing home floor plan(left) and integration result(right) Source: Lin Bai

Because care service is carried out for large group by limited staffs, the care service station normally was allocated very close or in centre area for the convenience to reduce moving distance in providing care service(SS in Fig.02). On the other hand, it reminds the community space was not getting enough attention in this kind of nursing homes. One factor is that there were only 17 nursing homes in the total of 40 investigated where community space was implemented, and in most of the deployed nursing homes, community space was situated in a place away from living or central area, as shown in this example(CS in Fig. 02). This basically causes lower spatial integration in community space, and high in service station in large scale care nursing homes.

Unit Scale Nursing Home

Normally unit care nursing home is constituted by multiple care units, each offers accommodation for about ten residents where nursing care is performed by exclusive staffs in accordance with resident individuality and the rhythm of life. By this concept, a common living space is designed in each unit where the light meal, nursing care and mutual activities are conducted. Besides, dedicated dining room, physical training room, and community space may also be furnished(Fig. 03).

The example is a nursing home built in 2005 in Okinawa for 112 residents, a two-story building with 5~6 care units in each floor. The care units were situated in 3 areas with each contains 1~2 units. In addition, a physical training room, a dedicated dining room were located in another area, and a community space with audio and visual techniques equipped hall was built in adjacent. The different functional areas were linked by connection corridors, and links between care units was done via open space(hall, lobby etc.) or short corridors(Fig. 03).

The calculation demonstrates the connection corridor is the space with highest spatial integration(right side in Fig. 03, number is the order from high integration to low).

Investigation also tells the community facility was implemented in 17 of the 22 investigated unit care nursing homes, and, it also found that in most cases it was located in middle or between different functional areas, which resulted its higher spatial integration as our example(#16 in Fig. 03).

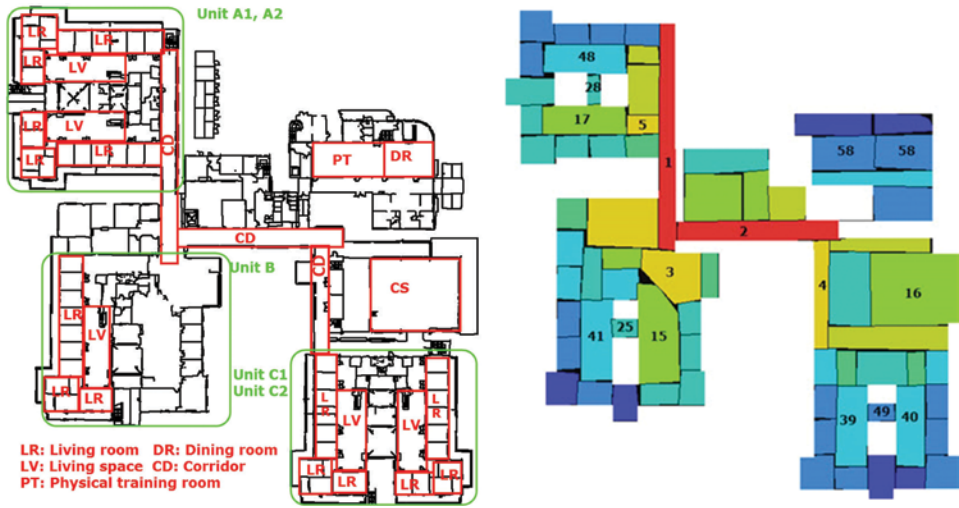

Fig. 03. Typical unit care nursing home floor plan(left) and integration(right). Source: Lin Bai

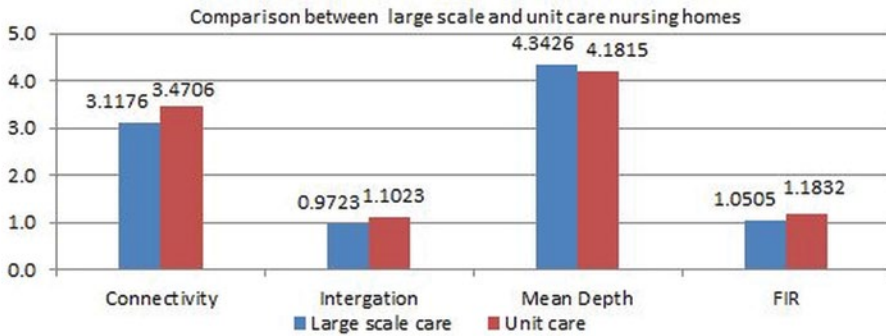

Fig. 04. Unit care nursing home with connection corridor as most integrated. Source: Lin Bai

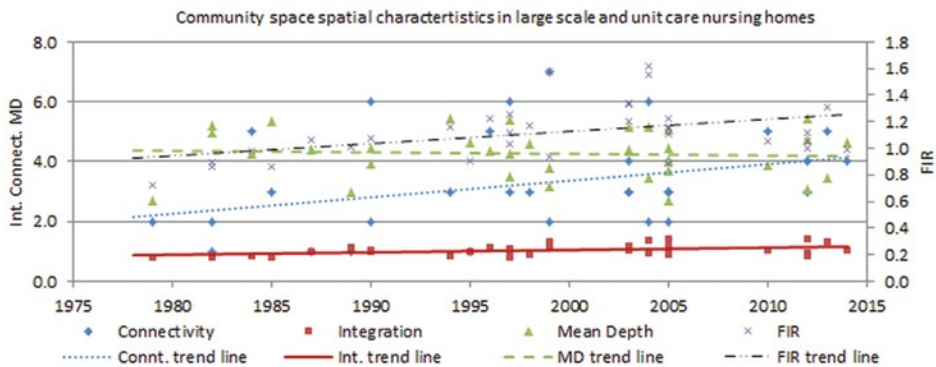

Fig. 05. Community space spatial characteristics overall changes in past 35 years. Source: Lin Bai

Comparison Between Large Scale and Unit Scale Nursing Home

The average integration, connectivity, mean depth, and FIR for community facility in large scale care and unit care nursing home is presented in Fig. 04.

Compared with large scale care nursing homes, the integration is increased by about 13% from 0.9723 to 1.1023, connectivity increased about 11% from 3.1176 to 3.4706, FIR is increased by about 13%, and, the mean depth is decreased from 4.34 to 4.18 in unit care nursing homes (Fig. 04).

This result reveals that community space has spatially been taken as an important common facility in unit care nursing home with more direct connections, less steps to access and higher spatial integration. And, the increased FIR also confirms that spatial integration of community space is about 18% higher than nursing home all space average in unit care nursing homes.

Overall Changes of Community Space in the Past 35 Years

The overall changes of community space in past 35 years is presented in Fig. 05, again, the integration, connectivity, and FIR was in uptrend (Fig. 05).

The FIR was changed from less than 1.0 in most nursing homes built before 1995 to more than 1.0 in that after 1995 (Fig. 05). This tells generally the community space has been positioned to place with higher spatial integration in most of nursing homes built after 1995. This result also reflects the change in consideration from accommodating more elderly with higher priority in early Japanese nursing homes to allocate community space to higher spatial integration place with higher priority in modern Japanese nursing homes.

The slightly decreased mean depth indicates the steps to access community space were decreasing, which also confirms that community space was getting to be situated to space with better access. Combined all changes in spatial characteristics above, it can be concluded that community space in modern Japanese nursing home generally has been getting spatially sited to a place with easier access and easier for people to gather together.

Conclusions

The analysis of spatial characteristics and community space in particular for Japanese nursing homes discloses that in classical large scale care nursing homes, the corridors along which living rooms and service facilities are distributed is the highest spatial integration place, and in modern unit care nursing homes, the route space links different functional areas basically is the highest spatial integration place.

The comparison between large scale care and unit care nursing homes confirms that the spatial integration, connectivity of community space is increased by about 13%, and the mean depth to access community space is decreased. This reveals the changes has happened in allocating community space to higher spatial integration place in modern Japanese unit care nursing homes.

The overall transition of community space in Japanese nursing home in the past 35 years also confirms its uptrend in both spatial integration and connectivity. This transition reflects a culture of connect to great community in modern Japanese nursing home design, that is, to make community space easily accessed and gathered by nursing home residents and local people.

Sharing Sketches: Architectural Outreach Projects with Elementary Students

Introduction

In an attempt to relate the teaching of beginning design students with outreach efforts to elementary students, this paper explores an experiment that involved a common sketch and assisted each of the sectors in their further understanding of the architecture profession.

Service outreach with 3rd grade students through Northeastern Pennsylvania's Architecture in Schools (AIS) has revealed common stereotypes about the architecture profession; therefore, the effort becomes much less about teaching architecture, but more accurately about dispelling the myths about architecture. This exercise looked at sharing a common denominator- a sketch- between two realms: the discussion with collegiate architecture students and the imaginations of 3rd graders. This common sketched assisted in educating both parties on the role of an architect. The second-year design students were engaged in visual literacy exercises, and the third graders were engaged in imaginative "landscapes" within a given context. This paper will take a closer look at this experiment along with another similar shared-sketch exercise.

Part 1: The University Design Students

The first part of this exercise—with a focus on understanding what a sketch is and what it could be—had its origins with 2nd year college design students. Up until this point in their design careers, a sketch had been a drawing that replicated the literal likeness of something. This is, in fact, in line with the general public's definition of the word as expressed in Webster's dictionary: *"a quick, rough drawing that shows the main features of an object or scene."*

But what happens when you want to explore preliminary ideas of intangible or ethereal versus an object or scene? This requires a new way of thinking about the word 'sketch'—or perhaps not *new* but now fully conscionable and focused. When thinking and conversing about architecture there becomes a need to relate it to its surroundings. Gestures and speech may become limiting when discussing ideas on the scale of a city, a park, or a plot of land. An alternate form of communication is necessary: a visual sketch. These "large scale" discussions beg for visual communication support along with the necessity to adjust scale via lines that we can put on paper—that we can

relate to and chat about. Verbal communication is important for support at this stage as students integrate this new meaning of ‘sketch’ to their arsenal of communication tools.

This notion of speaking while documenting ideas through sketching, records ideas in ways that are fairly novel when associated with the word sketch. Sketching while talking is what I refer to in this paper as an “in-line chat” (a play on and contradiction of the term on-line chat). This strategy enforces the notion that— though shifting from replicating to revealing, to collectively understand a site there needs to be a way to grasp it or capture it on a human scale that can bring forth layers and patterns which may otherwise be ethereal or non-visual.

The In-line Chat

Professor to student: chatting and sketching; lines become arrows that have meaning in order to convey a concept; cross hatch or shade is implemented to indicate something else perhaps more static in nature than the arrow. To engage in in-line chats is to collect ideas and information as a beginning step toward working out problems or finding new ones. The word ‘diagram’ is consciously left out at this point, because diagrams convey the delivery of information that has already been gathered and sorted, and represents more of a final product in a clear and simple manner; where sketch still pertains to the research, the brainstorm, and the messy phase that comes before the diagram. The in-line sketch is an important tool for the student to understand and it may be difficult to teach it without doing it. The sketches in (Fig. 01) have been illustrated by myself while speaking and collecting ideas with 2nd year university design students.

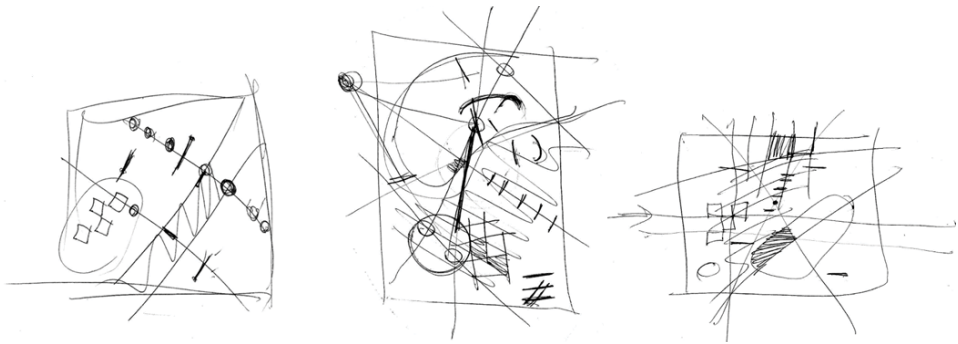

Fig. 01. The Images above represent In-line Chats: the product of sketching while conversing and drawing as a means of communicating an architectural process. Source: author

Once manifested on paper, the ‘in-line chat’ has now played its role: it has served as a thought from which to advance upon or to ignore. It is—more often than not—never seen again. This is true not only in architecture education, but in the profession as well. That sketch may very well be saved; but it is most likely archived indefinitely. These messy brainstorms are so much a part of our process of an architect; countless hours and days discovering and exploring solutions to problems in these thoughtful, messy sketches, and then they are discarded or hidden.

But not this time. The in-line chats between professor and student captured

relative meaning to a conversation. They grappled with notions of organizing and understanding topography, boundary, water flow, edges, site lines, air traffic, etc. When removed from the conversation the sketches retain an abstract sense of organization that can inspire abstract connections. Nonetheless, they showcase part of the art of architecture, and then essentially become solidified into abstract pieces that often record a fundamental understanding of context and surroundings.

Can this abstraction of a fundamental thought as preserved in these sketches be understood or even further abstracted by another person's thought on the organizational composition?

Part 2: The Third-graders

The exercise continued—or began an afterlife—in a creative experiment with 3rd grade elementary students. The in-line chats that were the result of once-meaningful sketch-exchanges of ideas and thoughts with 2nd year college architecture students became the context in which 3rd graders revealed their own understanding of a “landscape.”

Far from a blank piece of paper, or a coloring book; they were given an opportunity to see things; to search for things; to imagine or invent things; and then to respond to them. After all, that is an important part of what the architect is doing when embarking on a project. The original in-line chat became a permanent abstraction that once had inherent meaning; the 3rd grade students were then challenged with finding new meaning within it. You can see in the upper portion of (Fig. 2) the embedded in-line chat in which the children imagined new landscapes; and the lower portion shows an effort to finalize this new landscape after remove the abstract sketch.

The students enthusiastically imagined their own space and place at a scale that had nothing to do with the origination of the sketch, but only after discussions of representation helped them to see things differently than just lines and shapes. Discussions took place that related to how architects represent factors that are intangible like wind and direction; how architects draw lines that indicate meaning to a design; and how architects give a literal presence on the paper for things that are underground and above ground (transit lines and roof overhangs). This discussion of collapsing a vast amount of information into a sketch through mark-making prompted conversations relating to building and site systems and early considerations for sustainable strategies on different scales and how these may involve collaborative solutions or they may be integral to the role of an architect. In (Fig. 3) you can see the inclusion of wind and lighting systems, as others included power lines and windmills.

The experiment, though challenging in the beginning, proved to be very engaging as the young students seemed able to envision themselves in the context of the lines and shapes of the “in-line chat.” Many of the original sketch markings were reimagined in a literal sense as a valid interpretation; but also, many new markings by the students were made to impose ideas and to respond to their given contexts.

This exercise also introduced many of the students to tracing paper. The implantation of this can be seen in (Fig. 4) where a more finalized drawing has been created on the right. This introduction to a new medium alone provided enough

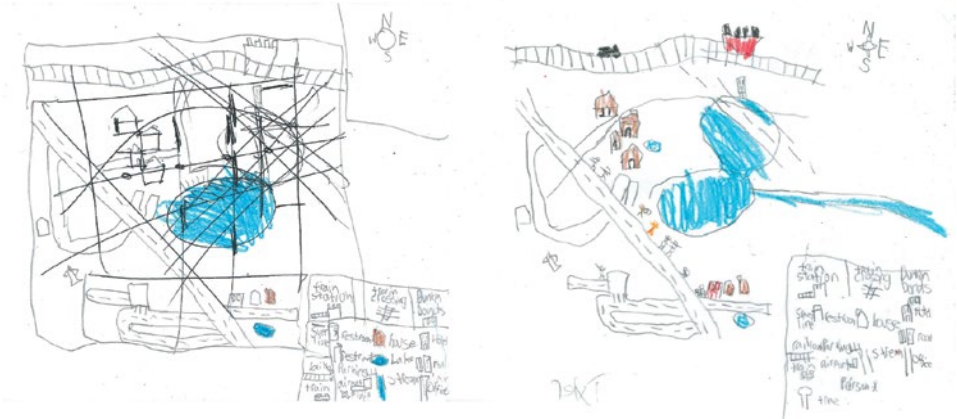

Fig. 02. A third-grade student imagines a new landscape within the in-line chat. The base sketch-drawing can be seen in the dark markings of the image on the left. *Source: author*

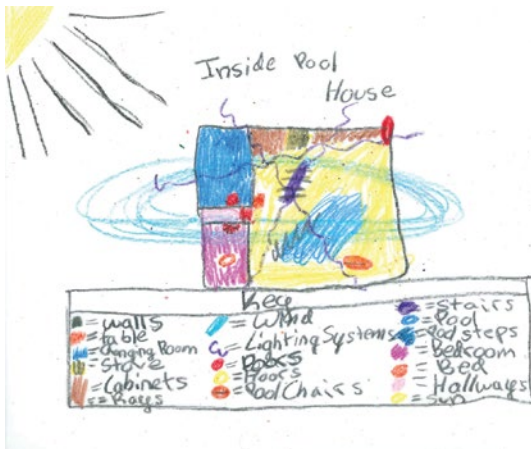

Fig. 03. Wind and lighting systems play a dominant role in this sketch. *Source: author*

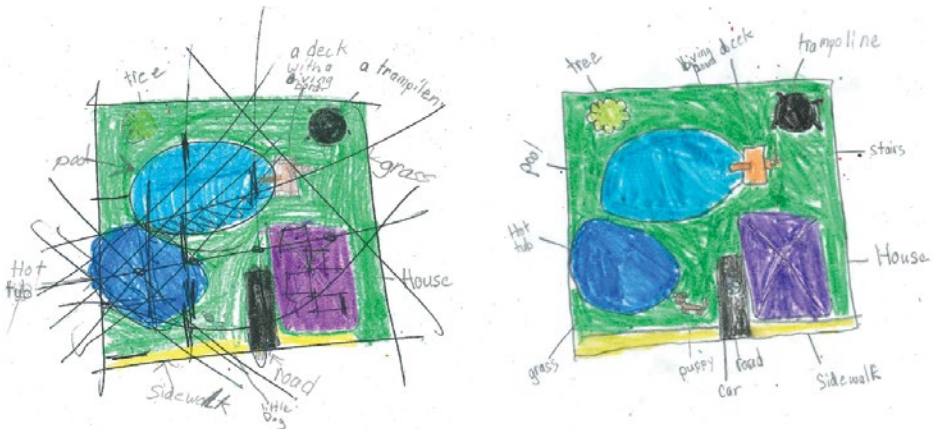

Fig. 04. This image highlights many of the revisions students made when transferring their designs onto trace paper. *Source: author*

excitement and motivation for them to push their designs forward. It also gave them another opportunity to reinterpret their own designs again and to revise a number of issues, including scale and program. Figure 5 showcases such a revision: the large “ice cubes” that were a result of residual square shapes of the in-line chat, have been revised to reflect the more appropriately-scaled lily pads resting in the pond.

An Outcome

This exercise was an attempt to have children understand the process of the architectural profession and emphasize the architects’ responsibility in the response to a non-blank canvas. Leaving this knowledge with them can serve as an effort to dispel the myth of the architecture profession. Although the face of the architecture profession arguably belongs to the construction documents; it is important to reveal the fun and the problem-solving aspects of the design process with the children. This exposure can only assist in clarifying creative aspects involved in architecture and other design professions.

Communicating ideas visually is paramount in the architecture profession. In-line chats reinforce this notion through pedagogical habits between professor and student within a studio setting. The complexity, organization and collection of meaningful markings inherent in these visual records of communication deserve to be expressed as part of the process and the art of architecture. Revealing these visual records by introducing them into exercises that encourage searching for problems in a given context and subsequently inventing solutions gives younger students a better understanding of the role of an architect.

Other Sketches: Sites and Scenes

While perhaps not as complicated as the above exercise, this next exercise, titled “Sites and Scenes,” looks at providing more ‘actual’ context in which young students can engage. (Fig.5) shows four sketches indicating environmental scenarios related to climate and geography: hot, dry desert; cold snowy mountain; cool, rainy forest; and warm, breezy beach.

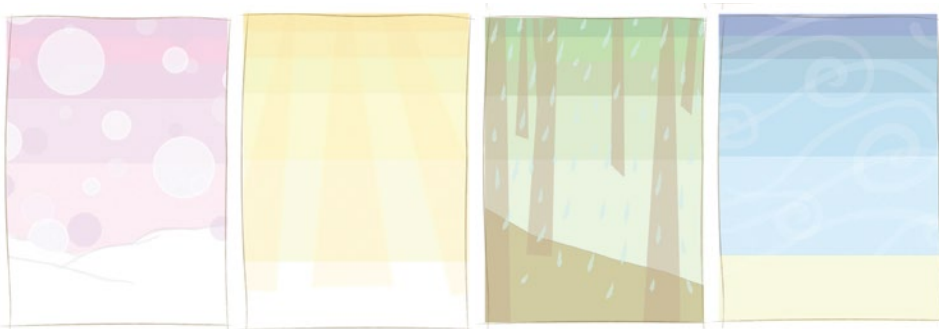

Fig. 05. Four digitally-sketched environmental scenarios to provide context. *Source: author*

After a brief discussion related to building in different climates, the elementary students were handed a scene and were tasked with designing a structure within that site that they can imagine inhabiting and activating. The discussion asked children to compare clothing and accessories that one might wear in certain climates to the way things might be built in those same climates. For instance, in the wintertime we wear large puffy jackets; this may relate to the need for thick, insulated walls. In the summer, we may wear a large brimmed hat; this may encourage a large roof overhang to keep the hot sun out of the interior space. And in both a rainy forest and a warm, breezy beach environment it can be nice to be elevated off the ground so that we can stay dry or so that air may circulate around the house to keep it cool. (Fig.6) demonstrates the level of engagement and detail that children put forth when trying to reconcile their preconceived notion of a building as it responds to the sky, the ground, and surrounding context it encounters.



Fig. 06. A third-grade student designing habitable space in a cold climate. This image showcases attention to wall thickness relative to environmental conditions.

Source: author

Conclusion

It is sketch exercises such as the two types indicated above, that begin to allow young children to activate their decision-making and design skills. At some point, the traditional coloring book stops challenging young students as its design decisions are limited to little more than color. But if we can share these other forms of creatively-minded exercises, we can encourage young students to engage their own imaginations and to question their own mark-making relative to scale, context and experience. It can give children the opportunity to see architecture for the thoughtful, problem-discovering, and puzzle-like negotiation that it is, and this can bring us one step closer to revealing the true nature and responsibilities of the architecture profession.

Tracing the Past: Establishing Tolerances when Investigating Medieval Vault Rib Geometries using Digital Tools

Introduction

This paper explores the digital documentation processes used to investigate the design and construction of medieval vaults in the British Isles. Here we can reopen investigations initiated in the past using techniques that are becoming widespread in the present, such as laser scanning and total station. We are also concerned with how our investigations are interpreted, particularly looking to the future once digital tools and techniques advance further still. We will focus our discussion on data collected at the east end of Wells cathedral in the south west of England and the choir at Ely cathedral in the east of England. Comparisons will be made between relative strengths and weaknesses of three different data collection methods as well as investigating the potential for human error by comparing the results when the same task is repeated several times.

Most Gothic vaults, as found in greater churches and cathedrals, work on the principle of first defining a series of ribs, with the in-between surfaces, or webbing, filled in afterwards either using, or at least subservient to, the geometry prescribed by the ribs already set out (Nussbaum and Lepsky 1999). This reverses the principle of stereotomy where the full geometry of a vault is designed prior to construction, which appears in neo-gothic vault examples in the nineteenth century. Our previous research suggests that to design and construct a medieval vault in the thirteenth and fourteenth centuries required the use of a tracing floor plan, where masons could experiment with 2D geometry in plan as well as projections from the plan to investigate the 3D design of each vault rib. This process resulted in a rich variety of vaults built throughout Europe and beyond which have long been studied to try to ascertain the different design and construction processes used. However, it is only now that digital surveying and analysis tools have become widespread that we can quickly and accurately document many vaults for analysis purposes; an issue which hindered pre-digital investigations (Willis 1842), as surveying vaults is logistically challenging because of their locations - often high up in church and cathedral interiors.

Methodological questions

In surveying the vaults our primary documentation method has been laser scanning, resulting in detailed and accurate point cloud models, which can also be converted to mesh models. Recently we have also experimented with total station surveying, and previous investigations have used photogrammetry (Webb, Buchanan and Peterson 2016). Using the survey data, vault ribs are digitally traced along intrados lines (their outermost edge) enabling us to extract data such as the radius, arc centre point in relation to the impost line, as well as the boss or apex height (Fig.01). The high accuracies prescribed using digital tools, however, opens a series of questions in the interpretation of such data. For example, if a vault rib has a radius of 4480mm and another related rib has a radius of 4360mm, is this difference of 120mm significant? Three scenarios are proposed:

1. It represents an intentional change in design by the medieval masons.
2. It is a result of acceptable tolerance levels in the design and construction process, including settlement of the vaults post-construction.
3. It has occurred due to inaccuracies in our own documentation methods moving from the physical artefacts to the digital representations.

The first and second scenarios are beyond our control, yet, if found, could be important in aiding our understanding of medieval vault design and construction. On the other hand, the third scenario is within our control and therefore becomes the focus of this paper, and its potential impact on the first two scenarios.

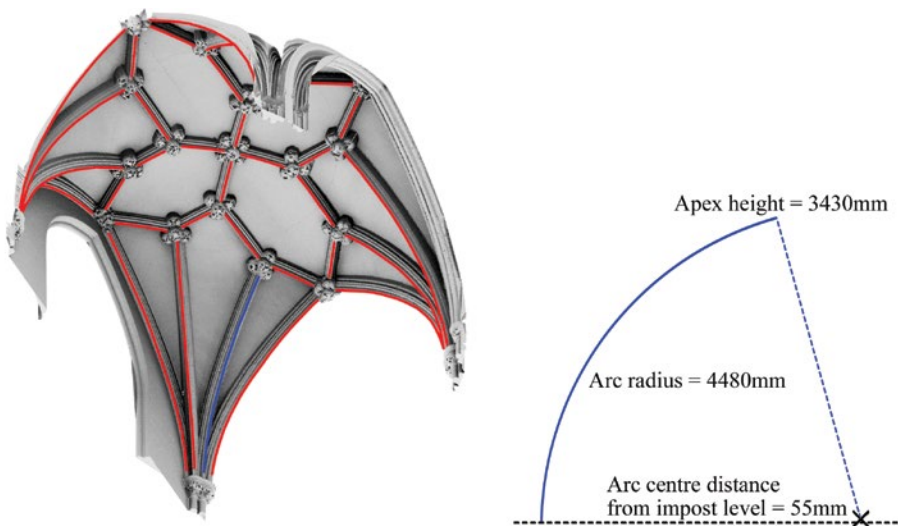

Fig.01. Tracings the mesh model of bay N5 at Wells cathedral, with rib Tr_Ti_2 extracted in blue to show its key geometry features.

Process options

To investigate possible inconsistencies in the digital data collection, we must first understand the processes used, and the different options available. In tracing intrados lines our standard method uses mesh models. This is because, as a surface model, it is

easy to visually locate intrados lines, particularly compared with point clouds (Fig.02). The mesh is traced in Rhinoceros 5 using the ‘three-point arc’ tool requiring start and end points, followed by a further point along the arc to form its curvature. There have been cases where capturing the curvature of vault ribs are more problematic, such as in the Lady Chapel at Chester cathedral, where ribs snake their way upwards making single arcs harder to define. However, at our case study sites this is not a significant issue. The main assumed problem in tracing mesh models using the arc tool is that each arc is created of three points. Therefore, as hundreds of points are available to ‘join the dots’, it is highly likely that if traced multiple times, a slightly different curve will be created. Hence one aim of this study is to test the scale of differences when the same rib is traced several times.



Fig.02. Three tracing methods used for the investigation. Mesh model (left), point cloud model (centre), and total station (right).

An alternative method to our standard mesh tracing procedure is to create arcs using the point cloud data itself (Fig.02). Here it takes time to locate the intrados lines amongst the other thousands of points, but once isolated, the ‘circle: fit points’ tool can be used to create a best fit curve through them. A further method is to use a Leica total station (Fig.02), where vault rib intrados lines are documented from the cathedral floor creating a series of digital x,y,z co-ordinate points. These are also joined together using the ‘circle: fit points’ tool in Rhinoceros 5. As the points along the intrados lines are the only objects in the digital model this is much simpler than using the dense point clouds. Potential issues with the total station method are intrados lines being inaccurately surveyed in-situ, such as not enough points being used to document them. We suggest seven points should be used across the breadth of each rib as a minimum.

Lines of enquiry

Based on the above, we will first explore these three different digital tracing methods using vaults surveyed at Ely cathedral. Our aim for the project is to continue with the mesh model method, therefore by looking at the two additional methods we can test the reliability of our mesh model results. Also, we will investigate the possible role of human error when tracing vault ribs using the standard mesh model method by comparing the same arcs which are traced on three separate occasions, this time using the vaults surveyed at Wells cathedral.

For each of the two investigations, two comparatives can be made. Firstly, we will examine each rib against their duplicate ribs. In relation to the Ely data we will compare the same rib traced three times using different methods and in relation to the Wells data we will compare the potential variations when traced multiple times using the same mesh model. Next, we will examine individual ribs against given clusters of data, for example, at Wells cathedral we established a radius of 4599mm as significant, therefore individual rib data can be compared against all other rib data forming the same set.

Establishing clusters is important to the project, as it enables us to identify patterns in geometry, which may provide clues as to how the medieval masons designed the vaults. Significant data clusters were initially identified manually, then, as it became apparent that more scientific methods were preferable, SPSS Statistic was employed. Statistical clustering enabled us to identify different cluster patterns and centres. With hierarchical clustering we could test different numbers of clusters, and identify the centre of these using K-means clustering. The hierarchical clustering method associates each piece of data to its nearest cluster centre using a squared Euclidean distance, and we could then identify how many clusters were required for the arc radii, arc centre's distance from the impost level and the boss or apex heights. This was aided using means, standard deviations and Z-scores.

The statistical and technical nature of this paper is necessary, as it offers an opportunity to interrogate base data to ensure that findings are as accurate as possible. Scholarly investigations into medieval vault design and construction using digital surveying and analysis tools are increasingly prevalent across Europe and beyond, whereas scrutiny of the base data and methodology is less evident in published work, which could potentially lead to misleading results and hypotheses.

Ely cathedral: comparing digital documentation methods

For this study, we utilised survey data from vaults of bay C8 in the choir, dated around 1328-1335, and the vaults of bay N8 in the north choir aisle, dated prior to the choir vaults (Pevsner and Metcalf 1985). Once all ribs had been traced using the three different documentation methods of mesh models, point cloud models and total station, we could record the required geometries and populate the results into a table, which were then investigated by comparing duplicate ribs, as well as rib clusters.

Comparing duplicate ribs

By tracing the three different sets of survey data, we had three duplicates for each individual rib, therefore we could initially calculate the average rib data of the three, followed by the standard deviation figure. For example, in bay N8 the radius of rib D1 was 3423mm when traced using total station data, 3249mm traced using the mesh model, and 3341mm traced using the point cloud data. This gave a mean of 3338mm and a standard deviation of 87mm. Once we had calculated these for all ribs in bay N8 and C8, we worked out average standard deviations across all the data, which could then be used to establish satisfactory tolerances (Tab.01). In the data, we removed the measurements of the longitudinal ribs and one set of longitudinal tiercerons ribs in bay

C8, as these proved difficult to record using total station, therefore a fair comparison could not be made between all three sets of data. Ely cathedral was our first use of total station, and we have since rectified the problem which prevented successful documentation of such ribs.

Table 01. Standard deviation averages when tracing each rib three times at Ely cathedral.

Averages	Arc radius	Arc centre distance from impost level	Boss or apex height of vault rib
Mean S.D.	107mm	84mm	32mm
Median S.D.	84mm	77mm	22mm
Maximum S.D.	340mm	250mm	74mm

Using table 01 to compare the full sample of 38 tracings (each traced using all three methods), we can be satisfied that most tracings will be reliable within the mean standard deviation figures, regardless of the method used to trace them. Table 01 also reveals that deviations are largest when analysing radii, and smallest when analysing the boss or apex heights. Finally, highlighting the maximum standard deviations in the table shows us that there are occasions where data is less reliable when comparing the three tracing methods. As such, we can use clustering to recognise possible poor data.

Comparing clusters of data

As described previously, we used clustering to identify trends within the data. Once these were defined we could highlight anomalies. To do this we first created a mean of all data in the cluster, followed by its standard deviation. We could then look at the distance of each rib from that mean, as well as calculating its Z-Score, which is a method of quantifying data that is increasingly distant from the mean data. We can use the Z-Scores to predict whether a rib’s data is within one standard deviation of the mean (that is a Z-Score between -1 and 1), and therefore whether we need to interrogate it further. Using this process, we could then check the tracings to look for errors in our process, and if found they could be re-traced. If the tracing process was deemed satisfactory, this then indicated a possible anomaly in the original construction of the vault.

Comparing Z-Scores outside of -1 and 1 in all three tracing methods, similar numbers of data were flagged in each case, suggesting all are equally reliable methods. In terms of deciding whether to continue with the standard mesh model tracing method, we can therefore look to the times taken to survey and trace the vaults in each case. This was 35-40 minutes for the mesh model, 65-90 minutes for the point cloud and 120-125 minutes for total station. As such, the mesh model method is easily fastest, so we will continue with this process for our project. It is likely that surveying and tracing vaults with point cloud and total station data will become more efficient with practice, however, we will use these as back-up datasets as we can now be confident our mesh model results are accurate within tolerances as demonstrated.

Wells cathedral: comparing multiple tracings

The second study compares the results of ribs traced multiple times, this time all traced using the mesh model method. The aim here was to establish acceptable tolerance levels, given that we know results are likely to differ slightly with every tracing. For this study, we utilised survey data from Wells cathedral, specifically bay N2 and S5 of the choir aisle vaults, probably 1330s and the north east transept vault, assumed completed by 1329 (Draper 1981). Once each bay was traced on three separate occasions, we could again populate the data into a table for analysis.

Comparing duplicate ribs

The first comparison was once more made by investigating each rib's three duplicate tracings, this time all using the mesh model method. A table recorded the rib radius, the distance of the arc's centre point from the impost level, as well as each rib's boss or apex height, which could then be used to calculate the average figures for each rib and to compare their standard deviations. In exactly the same way as the Ely cathedral data, we could then compile a summary table this time of the 54 ribs in the three sample bays, all traced three times (Tab.02).

Table 02. Standard deviation averages when tracing each rib three times at Wells cathedral.

Averages	Arc radius	Arc centre distance from impost level	Boss or apex height of vault rib
Mean S.D.	42mm	26mm	6mm
Median S.D.	28mm	15mm	4mm
Maximum S.D.	203mm	170mm	69mm

We can be satisfied that data is acceptable within the average figures given in table 02, regardless of who or when the mesh model was traced. On the other hand, if data lies outside of these standard deviations, we should interrogate it further. For example, for rib Tr3 in bay N2, the first tracing gave a radius of 4625mm, the second 4846mm and the third 4653mm. The second figure seems high, so this tracing would need to be checked. In our standard methodology, however, we would only trace each rib once and re-trace it if there were issues with the figures as previously discussed. As such we would not usually be able to compare duplicate data for ribs, and therefore looking at clusters of data is more informative. Having said that, the confirmation of standard deviations in comparing duplicate ribs is reassuring that our methodology is satisfactory.

Comparing clusters of data

Using SPSS Statistics we could again form clusters of data, this time for the vaults at Wells, and flag Z-Scores outside of one standard deviation from the mean of each cluster. For example we identified three clusters of radii, the largest being 4599mm. The first tracing of rib Tr1 in bay N2, which was found to be part of this largest cluster, had a radius of 4901mm and a Z-Score of 2.20. The second tracing

had a radius of 4743mm and Z-Score of 1.01 and the third had a radius of 4725mm and Z-Score of 0.95. This tells us that all three are above most figures in the cluster, however, we should be concerned about the first figure, particularly given its high Z-Score, and interrogate the tracing further. In reality, it appears that this rib does have a bigger radii, which again may give us clues on the design and construction of the vault. Similarly to the Ely cathedral data, we can use this process of creating clusters and Z-Scores to constantly critique and check our data.

Reflections and ways forward

Using the findings in each case we can formulate a set of tolerances to work with when tracing individual ribs. Comparing Ely cathedral (different survey methods) and Wells cathedral (multiple tracings), we decided to base our tolerances on the former as the average standard deviations were higher (Tab.01). As such we have a high level of confidence that the tracings produced will be satisfactory within these tolerances, regardless of the method used to trace them. Additionally, because the tolerances were smaller for the multiple tracings at Wells cathedral (Tab.02), we are also satisfied with these. In the future, we will therefore use the figures in table 03 as a guide, working to the nearest 25mm.

Table 03. Suggested tolerances for future investigations, with working examples.

	Arc radius	Arc centre distance from impost level	Boss or apex height of vault rib
Tolerance	100mm	75mm	25mm
Rib example 1	4480mm	55mm	3430mm
Reliable between	4380 to 4580mm	-20 to 130mm	3405 to 3455mm
Rib example 2	4360mm	100mm	3465mm
Reliable between	4260 to 4560mm	25 to 175mm	3440 to 3490mm

By testing our tracing methods through the different experiments, we have also established a refined methodology to follow for future case studies (Fig.03). The aim here is to identify a process, particularly when dealing with erroneous data. As such, if a rib is traced using the mesh model and, once clusters of data are identified, its data falls within one standard deviation of the cluster mean, the result will be deemed satisfactory (within the established tolerances as previously outlined). On the other hand, if the data falls outside of one standard deviation of the cluster mean, we will first check the 3D tracing for errors and if found, trace the rib again. If still problematic, this could be compared with ribs traced using additional survey methods, such as total station. If the result is still not within one standard deviation of the cluster mean, we could test additional clusters using SPSS Statistics. If additional clusters are found, the whole process is restarted. If no new clusters are found, the result can be confirmed as an anomaly.

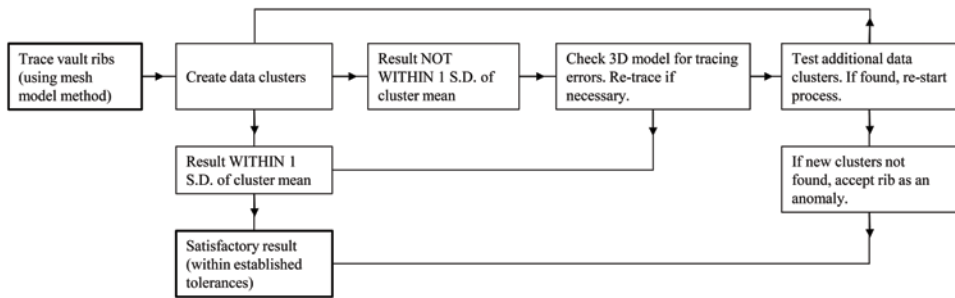

Fig.03. Proposed methodology to follow for future investigations.

It is highly likely that anomalies will be found in the data, due to the medieval construction processes as well as settlement. As such, the methodology cannot be used as an exact formula, and instead, along with the established tolerances, should be used for guidance only. In such research into vault design and construction however, we must re-state the importance of detailing the surveying and analysis methods used, which should fall under the same level of scrutiny as the results themselves.

Acknowledgements

We are grateful for the Society of Antiquaries' Lambarde Memorial Travel Award and the Paul Mellon Centre's Research Support Grant to fund data collection at both sites. We would also like to thank JR Peterson for his technical support, and Jiaoyue Zhao for her contribution in tracing the vault ribs.

Bibliography

- Draper, Peter "The Sequence and Dating of the Decorated Work at Wells"
in: *Art and Architecture at Wells at Glastonbury*. British Archaeological
Association Conference Transactions IV for 1978. 1981, p. 18-29.
- Nussbaum, Norbert; Lepsky, Sabine. *Das gotische Gewölbe. Eine Geschichte
seiner Form und Konstruktion*. Wissenschaftliche Buchgesellschaft:
Darmstadt. 1999.
- Pevsner, Nikolaus; Metcalf, Priscilla. *The Cathedrals of England: Midland,
Eastern and Northern England*. New York: Viking. 1985. p. 120.
- Webb, Nicholas; Buchanan, Alexandrina; Peterson, J.R. "Modelling Medieval
Vaults: Comparing Digital Surveying Techniques to Enhance our
Understanding of Gothic Architecture" in: Herneoja, Aulikki; Österlund,
Toni; Markkanen, Piia (eds.) *Complexity & Simplicity*. Oulu: ECAADE.
2016. p. 493-502.
- Willis, Robert. "On the Construction of the Vaults of the Middle Ages".
Transactions of the Royal Institute of British Architects. vol. 1 no. 2, 1842.
p.1-69.

Amos Bar-Eli

Interior Design Department, Faculty of Design, HIT – Holon Institute of Technology,
Holon, Israel

Spatial-Visual (New) Indeterminacy in the Architectural Threshold

Introduction

Architecture creates an interior space which is extracted-from, and is a division-of exterior space. This division, the architectural threshold, is understood as a zone of transition, transformation, and change. It is a space of indeterminacy with liminal, sometimes ambiguous, qualities. As early as mid-nineteenth century emerging technological advancements introduced new possibilities to the indeterminacy of the architectural threshold. The introduction of large glass panels has dissolved the boundary between exterior and interior space. Central to this theme is the gaze, which offers means of seeing, simultaneously, the various spatial conditions, resulting in enhanced spatial-visual indeterminacy. Transparency came along with a common effect: reflection, not only dissolving the architectural threshold but also fragmenting and multiplying it. Recent advances of projection and digital imagery are used and understood as architectural material. Superimposition of transparency, reflection, and projections is blurring the divide between interior-exterior, defining the (new) indeterminacy.

Architectural Threshold: The divide between interior and exterior

The architectural threshold cannot be dismissed simply as a passage from interior space to that of the exterior. On the social and psychological level transition situations are intense and complicated. They receive a ceremonial aspect, giving them importance and value. In these designated ceremonial times, change of form, status, and role, along with exaggerated, externalized, and forbidden behaviour is the norm. The re-ordering of social hierarchy requires a liminal period, in order for the new condition to establish itself, to mark its importance, and to properly distance one condition from the next.¹

The threshold as a metaphoric condition is well acknowledged in the arts, one example that towers above others is Czech writer Franz Kafka. The plots and

¹ Turner, Victor. *The Ritual Process: Structure and Anti-Structure*. Tel-Aviv: Resling, 2004 (1969) [In Hebrew].

protagonists of his stories are perpetually stuck in transformation, or metamorphosis. They decline the possibility of maturation, and perpetually fixed in a state of unfulfilled passion. The architectural descriptions preserve the plot in accordingly ambiguous and unwelcoming state. Closed doors, meandering paths, narrow passages, impaired vision, misleading directions, missing guides, constant blocks, and a whole range of movements with no apparent progression. Kafka's written spatial sequences are constructed in lumps, separate pieces with voids of unmeasurable gaps between them. A second mechanism, completely contradictory, is the possibility of 'jumps' that transgress enormous distances, as if through a magical opening. According to Kafka the neighbouring village is in the same time so far that it needs more than the time of a single lifetime to reach it. Meandering between these two literary techniques Kafka maintains his stories simultaneously surrealistic and realistic, humourist and sad, pessimistic and optimistic. By focusing on the constant transitory he was able to reconcile conflicting conditions of modern, urban, industrial bureaucratic society.²

The transition between the nineteenth and twentieth centuries was an intriguing historical period of social and cultural change. It marked a shift to industrialized, urban, consumerist society. A society in which indeterminate, fragmented, and transitory aspects affirm their precedence. These issues became the focal point for the cultural critique of German scholar Walter Benjamin. Benjamin chooses to analyse culture via the 'passages' of Paris. Covered exterior spaces, intermediate zones, containing both the macro of the public and the micro of the private. Benjamin dissects culture not via the heroic or the memorable but rather through the daily routines, the banal, and the minor. Benjamin discusses the architecture of iron and glass as a shift from the superficiality of decoration, and panoramic paintings capturing reality's rich details as distancing from nineteenth century romantic view. Focusing on phenomena such as photography, and mechanical reproduction, he developed the notion of culture's fragmented, and indeterminate identity. He explains this through the term 'Baroque Allegory'. A dialectical process in which everything becomes fragmented, receive complex and shifting meanings, and by the same process also lose all meaning. Benjamin managed to identify the conceptual complexities of indeterminacy which characterized twentieth century.³

Spatial-Visual indeterminacy in the architectural threshold

Interior and exterior spaces are loaded with psychological, philosophical, and theological meaning. The transition requires the threshold to have spatial and visual presence which is different from either one and share both. For example, the 'annunciation' fresco by Fra Angelico in the convent of San-Marco in Florence, created around 1450. In the painting the figures occupy an intermediate space, which is neither interior nor exterior, they are placed within the architectural threshold. The angel emerging from the garden, the exterior, is facing Maria who is seated within an

² Kwinter, Sanford. *Architectures of Time: Toward a Theory of the Event in Modernist Culture*. Cambridge MA: MIT Press. 2001.

³ Benjamin, Walter. *Collection B: Passing Thoughts*. Tel-Aviv: Hakibbutz Hameuchad. 1996 [Hebrew trans. From German].

architectural setting, the interior. It contains a small window through which we can see a glimpse back into the garden. So, the Interior contains within it the exterior, and this exterior is the container of the interior. (Fig.01) This is a paradoxical loop-like concept which perplexes artists and thinkers. The spatial setting corresponds conceptually to the idea of the Trinity - the union of Father, Son, and Holy Ghost in one Godhead,⁴

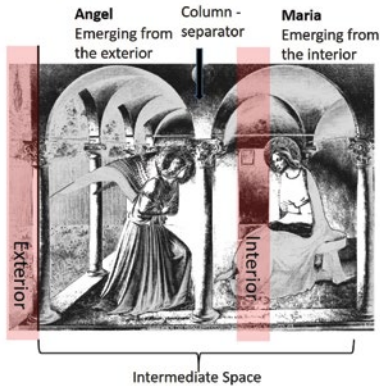

Fig. 01. Spatial analysis in Fra Angelico 'annunciation'
Source: author



Fig. 02. Barcelona Pavilion, visited 2015
Source: author

The architectural threshold space is unique in the manner by which it accommodates social practices and interaction. In 1908 architect Adolf Loos published the article "Ornament and Crime". In it, Loos claims, that in the same way that modern man does not need a tattoo to establish his identity, so does the modern building should remain simple and clear of decorations. The article indicates modern architecture shift of interest toward aesthetics of pure materiality and construction. But this is not only elimination of content from the skin, but rather a major switch in the role of the architectural threshold, from a simple surface toward a spatial condition. It reconfigures the architectural skin from a divider that can be decorated to a spatial condition that can be occupied.

Loos interest is with interior and exterior as two forms of social existence: the private and the public. As such his designs reflect a distinct difference between them, and emphasizing unique meaning to the threshold as a spatial condition. From the threshold, you can see both interior and exterior, so by the gaze you can regulate and supervise social behaviour. At the same time as your gaze falls upon the other you are also exposed and at the sight of the other. Loos threshold spaces are indeterminate: by their position (inside/outside), function (supervise/spectator), and social role (actor/director).⁵

⁴ Barnaby, Nygren. "Fra Angelico's San Marco Altarpiece and the Metaphors of Perspective". Notes in the History of Art. vol. 22 (1). 2002. p. 25-32.

⁵ Colomina, Beatriz. Privacy and Publicity: Modern Architecture as Mass Media. Cambridge, Mass: MIT Press. 1994.

The emergence of large panels of transparent glass has introduced new concepts and possibilities into the relationship of interior-exterior. In the twenties and thirties of the twentieth century German architect Ludwig Mies van der Rohe proposed architectural visions which set a new direction to the issue of division between interior and exterior. Glass with its transparent quality was envisioned as capable of eliminating the architectural threshold as separator of space. Transparency offered clarity, purity, and perpetual continuity of space. Mies methodologies were three-fold: simplicity - as means to eliminate symbolic meaning from the architectural skin, fluidity – placing the walls freely in space, and transparency – allowing sight to travel unobstructed. In his Barcelona Pavilion of 1929, a complex visual occurrence takes place. (Fig.02) The large transparent glass, the reflective water pools, the polished marble, and the mirrorlike steel columns, create a dazzling visual fragmented superimposition. An indeterminacy in the architectural threshold.⁶

‘Projections’ as architectural material

The capturing, transmitting, manipulating, and projecting of digital images became central to current life and culture. In the past decade technology of the ‘projection surface’ has dramatically transformed it from object to material. Until not too long ago ‘projection surfaces’ were confined as household objects, such as TV. Although many types exist they are characterized by producing their own light source, and of being thin. Having their own light source makes them independent from environmental conditions. Being thin imply that they can be applied upon a surface almost like paint. ‘Projections’, can be understood as architectural material, they can occupy large surfaces, be merged with other materials, and divide space.

First designs that experimented with the sensory indeterminacy of projections were conducted by the Eames couple. During the late fifties of the twentieth century they designed large multi-media exhibitions. Their model was the ‘circus’, an event which offers a multiplicity of simultaneous experiences. They used many screens of extremely large size, and projected multitude of image sequences choreographed and synchronized, with the aim to: “...produce sensory overload... The audience drifts through a multimedia space that exceeds their capacity to absorb it”.⁷

American architecture researcher Sylvia Lavin discusses the emerging relationship between the projected images and the architectural surface. Her notion of the interaction between solid form and materiality - architecture, and the ‘soft’, transformable nature of the projected media, is correlated to the act of kissing. This superimposition transforms both the architecture and the projection. The projection receives a unique context, and the architecture gains new visibility. It is a kiss-like relationship, Lavin states: “But their effect on architecture is to cause architectural facades to disobey notions of frontality, coherence, and transparency. Projected images break the planes of a building into parts that never come together again to

⁶ Evans, Robin. *Translations from Drawing to Building and Other Essays*. London: Architectural Association. 1997.

⁷ Colomina, Beatriz. “Enclosed by Images”. *Grey Room*. issue 02. 2001. p. 19.

compose an envelope”⁸.

American architecture firm Diller, Scofidio+Renfero created thought provoking projects that question the relationship between digital media and architecture. Their 1996 ‘Jumpcuts’, is a project made of Twelve screens positioned on the glass facade of a movie theatre. The screens are fed by live cameras pointed to escalators in the interior lobby. The movement of the escalators and people is projected and reconfigured dynamically across the facade, interrupted occasionally by movie trailers. Viewed from the outside, multiple superimposition of the real with the projected interior, a fragmented interplay of content, scale, and perspective. “Travelogues” (2001) is a 33 screens installation in an airport corridor. Each screen displays a one second film, corresponding to the time passengers walk pass each screen. The location in an airport, a non-place space, the content, and length of the movies, the state of limbo of the viewers, all enhance the indeterminacy of the space. Their “Facsimile” from 2004 consists of a large projection monitor suspend on the glass facade of an office building. The monitor glides slowly across the transparent facade. It is fed by two sources. One is a live scan of the interior and the second are pre-recorded images that correspond to fictive office or hotel interior. In this way, a constant interaction takes place between the real, the projected, the pre-recorded, and the constant movement of the screen. Summing up the unique attributes of projections as architectural material:

- Self-light source - they don’t rely upon external light conditions.
- They are very thin - they are not perceived as objects.
- Common use - affordable, accessible, and easy to maintain.
- Flexible in design - they offer multitude of shapes or size.
- Flexible in content - image quality and unlimited options of content.
- Interactive - responsive to touch, gestures, and sensory interaction.
- Augmented/virtual/Free floating 3D - a feasible possibility.

(New) indeterminacy in the architectural threshold

Introduction of large transparent glass panels late in the nineteenth century offered new possibilities for the architectural threshold. Glass unique attribute is its transparency and reflectivity. What you see is not the material itself but what lays behind it, and when reflective, what is seen lays behind the viewer. The late decades of the twentieth century introduced technological advances of digital imagery. Those accelerated in rapid speed and use, becoming a dominant presence in architecture and culture. ‘Projections’ are changing and dynamic, they portray movements and transformation, and are not limited to the immediate time or space which the ‘projection surface’ is located in.

The architectural threshold, is now loaded with a mixture of transparency, reflectivity, and projections. This creates an extensive effect of fragmentation, superimposition, and partial views, blurring the distinction between interior and exterior. A new possibility is added: the elsewhere and the other-time, superimposed with the here and now. Realistic spatial conditions are intermingled with the imagined

⁸ Lavin, Sylvia. *Kissing architecture*. Princeton & Oxford: Princeton University Press. 2011. p. 47.

and speculated. This is not merely a visual by-product but rather as a reflection of current culture, which is essential for understanding current architecture possibilities.⁹ The visual aspects of this (new) indeterminacy are defined by the, sometimes conflicting, mixture of:

- Viewpoints and Perspectives
- Distances and scales
- Movement and speed
- Meaning and intent
- Realistic and imagined
- Present and past

Possible interactions of the above list are no less than bewildering. The nature of the (new) indeterminacy is described as a spatial surface-thickness and visual flat-depth. The thinness of glass does not dissolve the threshold but rather introduces more spatial possibilities. Creating a varying thickness to the architectural skin inhabited by social functions, chance occurrences, and symbolic intentions. (Fig.03) The visual mixture, resulting from the introduction of projections, created a visual condition of hyper-multiplicity of imagery and content. The superimposition of conflicting, and shifting viewpoints, scales, meanings, and mediums creates a flat surface of unmeasurable depth. The viewer is submerged in imagery. In this sensory overload, the body is simultaneously creator, participant, and a helpless victim.



Fig. 03. Street view

Source: author

⁹ Vidler, Anthony. *Warped Space: Art, Architecture, and Anxiety in Modern Culture*. Massachusetts: MIT Press, 2002.

(New) indeterminacy is characterized by constant discontinuity of space and consciousness. Perspective does not order objects in space, and time does not regulate actions. Our bodies are immersed in imagery overload which continue to flow endlessly, with no apparent objective, intermingle un-purposely in unpredictable manner, and superimpose in countless formations. (Fig.04) The unexpected is the only predictable, the unstable is the only constant, disharmony is the only rhythm, discontinuity is the only permanent, fragments are the only whole. In which the real or the haptic is neither central nor determinative.



Fig. 04. Street view
Source: author

Summary

Spatial-visual (new) indeterminacy in the architectural threshold presents a distorted reality in which the here and now are neither here or now. It is a kaleidoscope with no geometric logic, a wonder world of Alice, Piranesi-prison gone haywire, Tower of Babel in every store-front, a jungle of possibilities, it is world submerged in its own dream. This can be read as collapse of order or rather an emphatic and human externalization of our inner consciousness. As are these words by Italian writer Italo Calvino: "... who are we anyhow, who is each of us if not a collection of experiences, data, readings, imagens? The life of each person is an encyclopedia, library, items list, collections of styles, and all can mix constantly and rearrange anew in all possible manners".¹⁰

¹⁰ Calvino, Italo. American Lessons: Six Suggestions for the Next Millennium. Tel-Aviv: Zmora-Bitan. 2012. p. 172. [In Hebrew].

The spatial-visual (new) indeterminacy in the architectural threshold is not merely an outcome of emerging technology, it is a reflection of contemporary society as well as a determinate factor in evolving culture. One can choose to ignore it, it can be criticized as dystopia or praised as utopia, but this misses the point. It is rather the design implications and possibilities which are of importance. It is our obligation as designers to be responsive and work with it.

Many questions arise in relation to this reality. How should we orient ourselves in this spatial-visual havoc? Is the notion of orientation an obstacle in itself? What are the design tools which are adequate for such reality? And how does this effect design education? This is a new territory for design and design thinking. A new vision for contemporary society. It is our responsibility to acknowledge, decipher, and familiarize ourselves with this condition, to interpret and re-interpret, to critique, evaluate, accept, reject, or reconcile. It is contended that the spatial-visual (new) indeterminacy in the architectural threshold is a feasible and contemporary reflection of both current society and a representation of interior human consciousness in contemporary culture.

Bibliography

- Barnaby, Nygren. "Fra Angelico's San Marco Altarpiece and the Metaphors of Perspective". *Notes in the History of Art*. vol. 22 (1). 2002. p. 25–32.
- Benjamin, Walter. *Collection B: Passing Thoughts*. Tel-Aviv: Hakibbutz Hameuchad. 1996 [Hebrew trans. From German].
- Calvino, Italo. *American Lessons: Six Suggestions for the Next Millennium*. Tel-Aviv: Zmora-Bitan. 2012. [In Hebrew].
- Colomina, Beatriz. *Privacy and Publicity: Modern Architecture as Mass Media*. Cambridge, Mass: MIT Press. 1994.
- Colomina, Beatriz. "Enclosed by Images". *Grey Room*. issue 02. 2001. p. 6–29.
- Evans, Robin. *Translations from Drawing to Building and Other Essays*. London: Architectural Association. 1997.
- Friedberg, Anne. *The Virtual Window: from Alberti to Microsoft*. London, England: The MIT Press. 2006.
- Kwinter, Sanford. *Architectures of Time: Toward a Theory of the Event in Modernist Culture*. Cambridge MA: MIT Press. 2001.
- Lavin, Sylvia. *Kissing architecture*. Princeton & Oxford: Princeton University Press. 2011.
- Turner, Victor. *The Ritual Process: Structure and Anti-Structure*. Tel-Aviv: Resling. 2004 (1969) [In Hebrew].
- Vidler, Anthony. *Warped Space: Art, Architecture, and Anxiety in Modern Culture*. Massachusetts: MIT Press, 2002.
- <http://www.dsrny.com/> (accessed 17.04.2017)

Maki Kasahara ^a, Akihiro Mizutani ^b Kiwa Matsushita ^c

^{a,c} Department of Architecture, School of Science and Technology for Future Life, Tokyo, Japan ^b Department of Architecture & Civil Engineering, Toyohashi University of Technology, Aichi, Japan

Analysis of Algorithmic Design Process – Case Study of Agricultural City Project by Kisho Kurokawa

Introduction

When multiple architects work on a large-scale project, it is useful to build common rules or system, upon which the entire scheme can be based. The computer-aided design is able to build such an algorithmic system, which is reproducible by anybody. At the same time, however, the character and/or attraction of architecture maybe created by the indeterminate factors, which are often subjective interventions by humans. This research aims to clarify the balance between the determinate and indeterminate factors in architectural design by using the program, Grasshopper, to verify the design process of the Agricultural City Project by Kisho Kurokawa (1934-2007) as a case study (see Fig. 01).

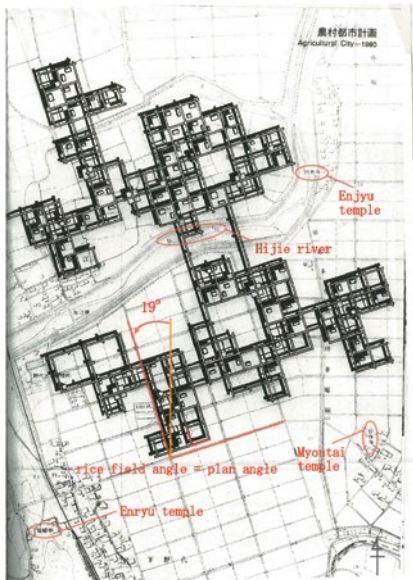

Fig. 01. Original plan of Agricultural City Project
Source: Kisho Kurokawa's World, 1975

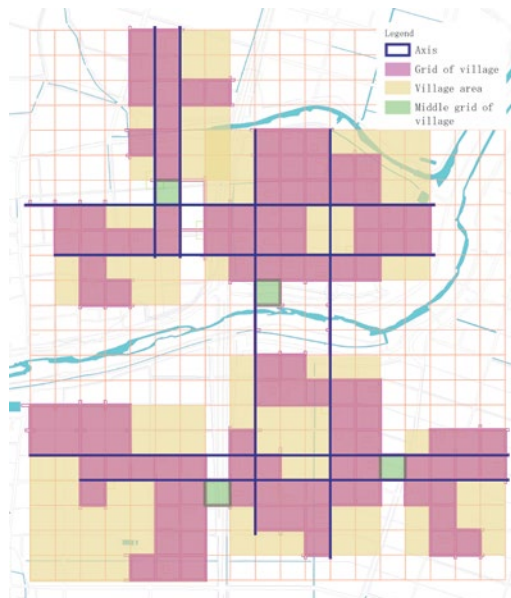

Fig. 02. The Analysis of the plan
Source: author

The Selection of the Subject

Kurokawa's Agricultural City Project, first presented in the Metabolist booklet in 1960 issued for the World Design Conference held in Tokyo, is an unrealized, visionary project, which proposed the agricultural settlements on the expandable and gridded street network and artificial ground, raised four-meter above the ground to avoid a damage from the flood of the river. It was designed as a reaction to Kurokawa's own experience of Ise-bay Typhoon and its damages on the actual agricultural settlements. The project received the international attentions upon the presentation at the World Design Conference, which lead it to be exhibited at "Visionary Architecture" exhibition at the Museum of Modern Arts, New York.

Although the computer was not used for the design, due to the influence from his teacher, Kenzo Tange (1913-2005), Kurokawa was keenly interested in design process based on the algorithmic system. The key concept of the Metabolism, the responsiveness to the environment and reproducibility in the cities of growing population, suited well with the algorithmic design. Kurokawa, on the other hand, has a strong personal design sense, which is also apparent in this project. Thus, the Agricultural City project is an appropriate example, studying the balance between the determinate and indeterminate factors in architectural design.

The Procedure of the Research

First, the drawings of the project were reproduced based on the original documents. After careful reading of Kurokawa's texts on the Agricultural City Project and other relating projects and scrutinization of the plan, several hypotheses were made on his logical design rules. Those hypotheses were verified by writing the computer program according to the rules using Grasshopper. The parts which are not reproducible by the computer program can be differentiated as the indeterminate factors which may depend on Kurokawa's subjective sense.

The Analysis of the Project

The Agricultural City Project has two versions: 1. a single cluster and 2. the version which several clusters were planned onto the actual site. The single cluster consists of 5 by 5 grid, of which each square measures 100-meter by 100-meter. The artificial raised ground was made in each square, on which 20 houses were planned to be built. An average size of the existing community, approximately 340 households of 1700 people were intended to live, and the public buildings, such as Shito shrines, schools, and community centers were also designed to be built on the artificial ground. The grid acts as the streets as well as the supply lines of water and electricity. This grid of 500-meter square constituted a cluster of a community.

The second version was planned over the river in the actual site. It was designed based on the algorithmic system for the future expansion, so that close analyses were made on this version. Unlike the single cluster type, the edges of the grid in this version stretch to all directions and the formation of each cluster is not clean square. The projections from the grid reflect the metabolists' thought of growth, and the variation of projections range from 10m to 35m as shown in Table 1.

Table 01. The types and number of the validation of projections

types of the parts projected direction of the parts projected	0. 10m	1. 15m	2. 20m	3. 25m	4. 30m	5. 35m	Total	
1. +X	0	9	8	1	0	0	18	} = 33
2. -X	0	6	5	3	0	1	15	
3. +Y	0	8	9	0	1	0	18	} = 40
4. -Y	2	15	5	0	0	0	22	
Total	2	38	27	4	1	1	73	

+X,-X whole number of peripheral intersecting point :51 locations +X 35%, -X 29%, ±X 32%

+Y,-Y whole number of peripheral intersecting point :48 locations +Y 38%, -Y 46%, ±Y 42%

Source: author

The types of artificial ground, the edge condition of the grid, and were analysed to find the common rules.

In the written description of the project, the site was set in as Ama county Kanie town, Aichi prefecture, which was Kurokawa’s hometown, but the actual site was found in Kuwana city Tado town in Mie prefecture, which was located in 20 kilometres west from the original location by matching the form of the river and location of three temples on the drawing to the current map. Also, the single cluster was configured to be 100-meter by 100-meter, but in order to superimpose the plan onto the actual site, the scale of the plan had to be reduced to 60% of the original. By doing so, grid fitted to the angle of the rice field, and the artificial ground was placed to avoid overlapping in with river.

Artificial grounds were formed on the grid, and there are 6 types as shown in Table 2: a.100-meter×100-meter, b.75-meter×75-meter, c.25-meter×25-meter, d.50-meter×75-meter, and e.100-meter×25-meter to be a type of ground exist inside the grid, and f.75-meter×75-meter is existed on the intersection point of the grid.

In the analysis of overall framework four sets of double axes were, alternatively extending to the north-south and east-west directions. The clusters were formed as a prototype of single cluster type, on the double axes, but adjusted to different conditions of the actual site and avoiding interference from the other clusters. The grid area cover 60% of the village area, and there are more than 1 square grid between different villages to differentiate them from each other. The hypotheses were made that the expansion of the grid and the formation of cluster were the determinate factors, while the number, type and location of the artificial ground showed that they were indeterminate factors.

Verification of the Analysis

The hypothesis of the design process based on the analysis above was verified by writing an algorithmic program to replicate the project using Grasshopper (see Fig. 04). The parts of procedure, which the project can be reproduced using the same component in Grasshopper suggest the algorithmic system. The formation of double

Table 02. The types and number of the grid grounds, *Source: author*

Type	5 types of inside the grid land					Grid intersected land
	a. 100	b. 75	c. 25	d. 50	e. 25	f. 75
Number	12	28	15	14	1	5

The detailed classification and the number of b, c, d

b.		12		5		3		8
c.		2		2		7		5
d.		4		4		1		5

Legend
 Grid frame
 Artificial ground

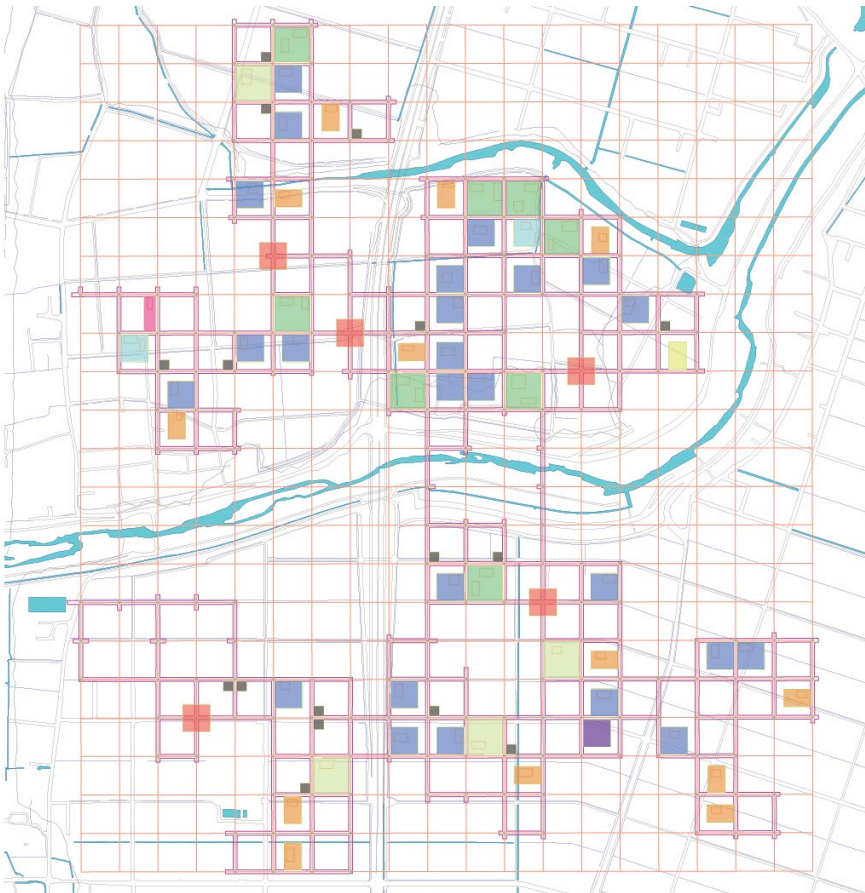

Fig. 03. The verification of the plan, *Source: author*

axes and shift of central points could be reproduced in such a procedure. Also, the clusters are formed according to the different conditions of the surroundings, such as river and mound, and the distance between each other, which seem to have certain rules.

The artificial ground have several but the same types of the ground are never placed next to each other. Thus, the program to form the artificial ground was written according to the following process.

The artificial ground types were placed in order of their sizes starting from the largest type. To avoid placing in the same location, “Dispatch” command is used, at every term of setting a new type of artificial ground. The appearance of grounds b.c.d. depend on the orientation, so these 3 types were divided into four sub-types orienting to four directions, and placed in random order(see Table 02). Only f. has the center point at the intersection point of grid, so there are possibilities to be placed over the other grounds. This time a version of seed=5 was selected which has no overlap of artificial grounds (see Fig. 05, 07).

The locations of the center points of the community as well as types of artificial lands, however, could not be replicated without typing in certain numbers, which suggest that they are based on the indeterminate factors. These indeterminate factors allowed the architect to give more spontaneous and expandable appearance to the project, as well as give a room for the residents and community to have their input if the project had had been realized.

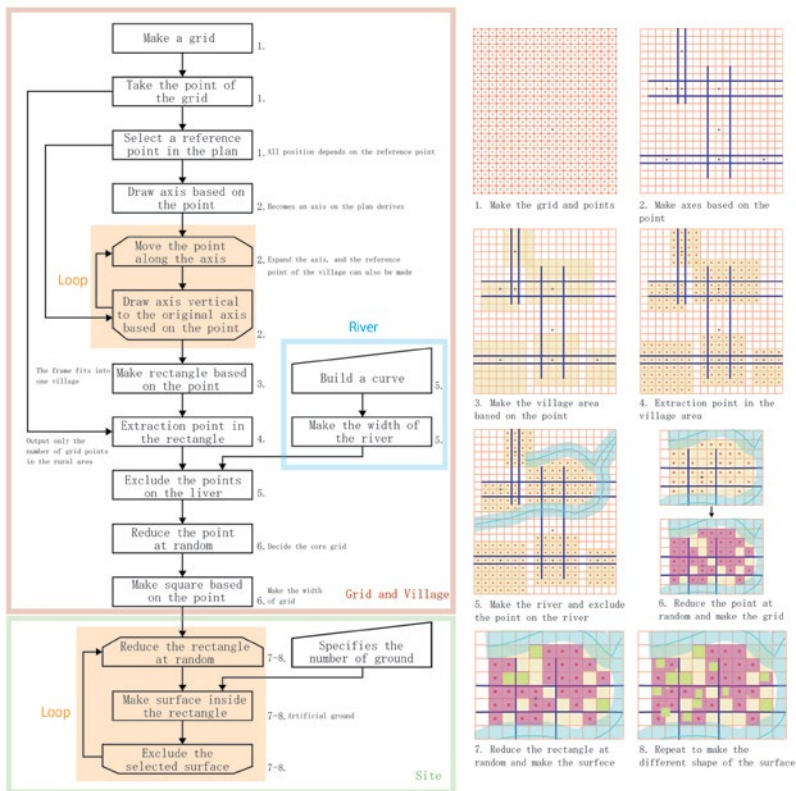

Fig. 04. The program of analyzing the plan
Source: author

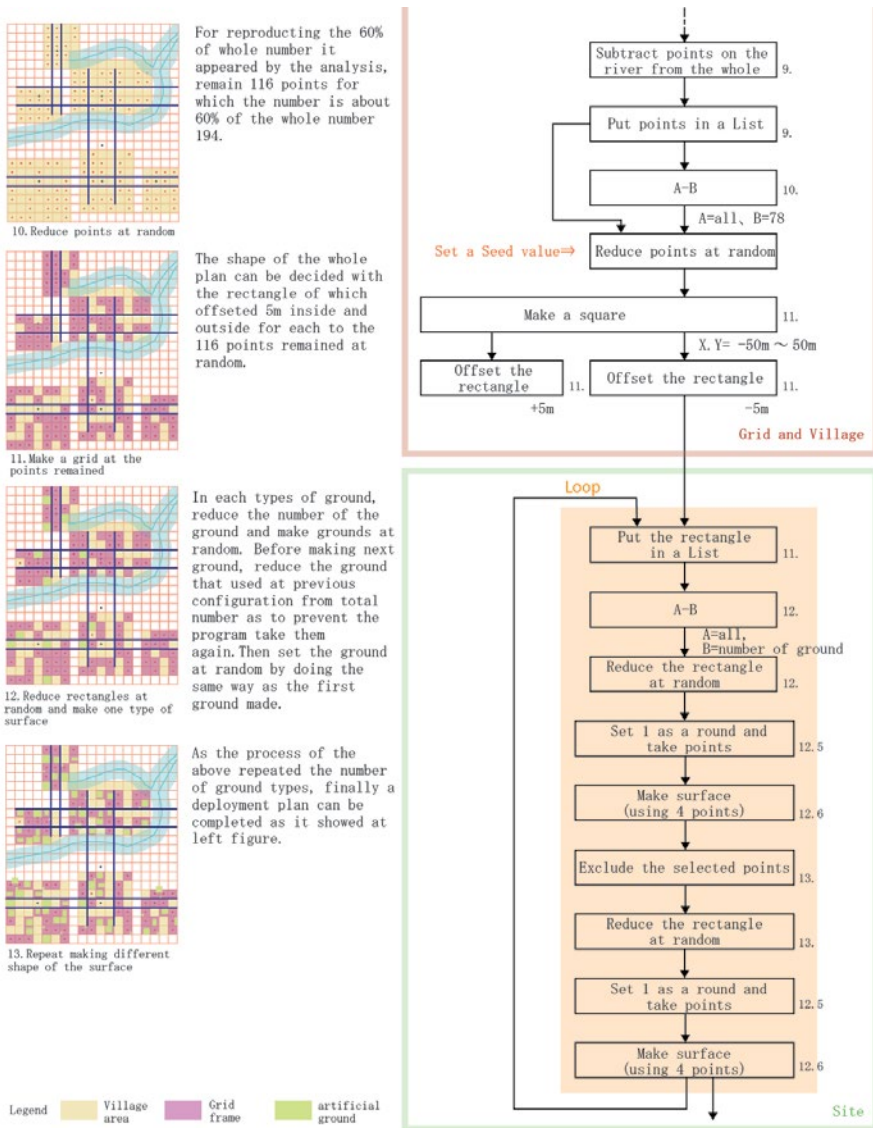

Fig. 05. The detailed program of making the grid grounds, Source: author

Create a ground

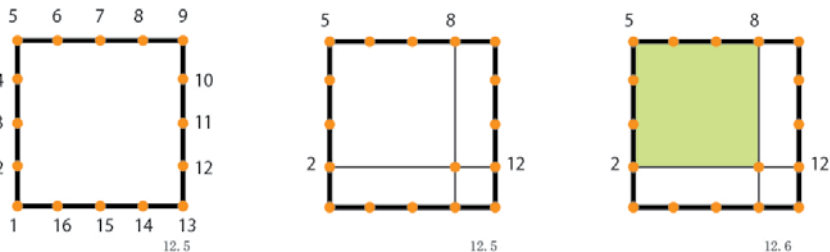

Fig. 06. The explanation of separating the grid rectangle and making the grid grounds, Source: author

The procedure of making artificial grounds.

Separate the grid rectangle to 16 equal parts. Then number the split points from 1 to 16. From the numbered points, take a list of points out that through vertex of the ground to create. Make a surface using the 4 vertices. All the ground made by those 16 equal parts, so it is possible to make all the ground by using the same way. Only the ground f. has the center point at the intersection point of the grid, it should move (50m,50m) after making the surface (see Fig. 06, 07).

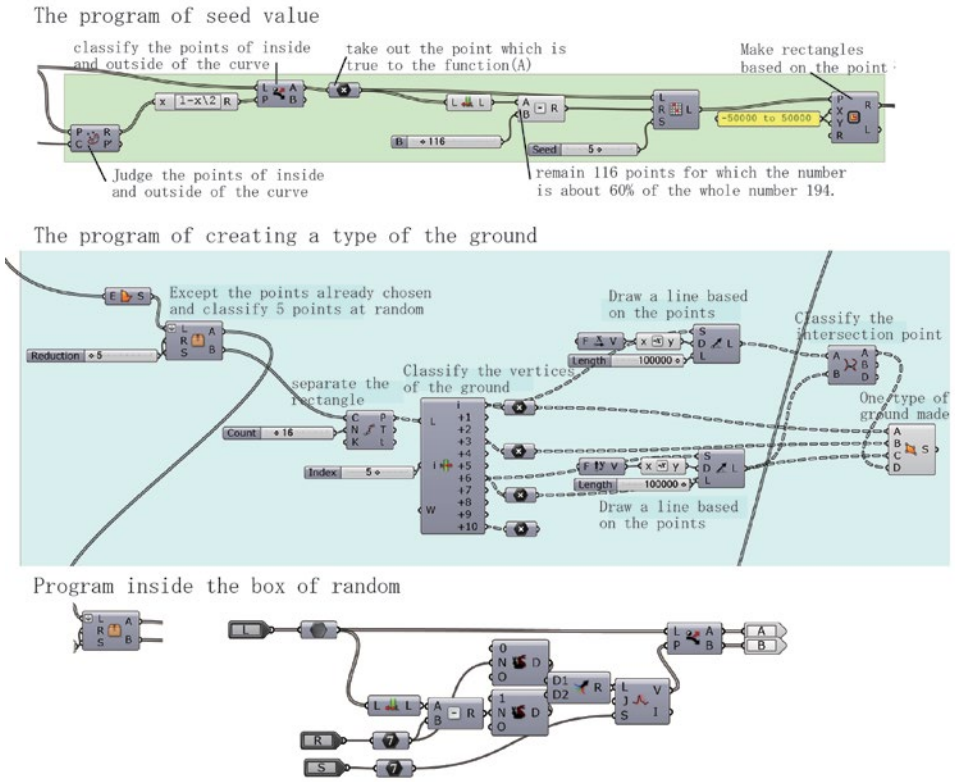

Fig. 07. The grasshopper program of the plan
Source: author

Conclusion

The algorithmic program could recreate certain parts of the Agricultural City Project, but the other parts were not reproducible by the program. The results differentiated the determinate factors (double axes, clusters) from the indeterminate factors (location of grid, type and number of the artificial ground). It can be speculated that the determinate system is more apparent in the elements which relate to the fundamental design concept or the prototype, while more superficial form-related design, which may depend on the personal

and subjective decision by the architect, appear in the indeterminate system. The hypothetical logic of design process of the Agricultural City Project was verified through writing the replicable program in Grasshopper. Agricultural City Project is planned about 60 years ago, although it can be reproduced by using the new technology grasshopper, so that means consciously or unconsciously some rules are based in the past as same as now make a plan of architecture. This verification method using the computer program clarifies the characteristics of the algorithmic design process, which could also be seen in Kenzo Tange and other Metabolists works.

Bibliography

Books:

Metabolism 1960; Metabolist group: Bijyutsu Publishing House.

Action Building Theory- Aesthetics of Metabolism; Kisho Kurokawa: Syo-koku House. 2011.

Ideas of Metabolism; Kisho Kurokawa: Hakuba Publishing House. 1972.

Homo Movens Future of City and Human; Kisho Kurokawa, Chu-o Kouron House. 1969.

Kisho Kurokawa's World; Kisho Kurokawa:Mainichi Newspaper House. 1975.

Publications and documents without author:

Modern Architecture, April – May 1960: Kindaikenchiku shuppan House.

Modern Architecture, November - December 1960: Kindaikenchiku shuppan House.

Architecture Culture, September 1959: Sho-koku House.

Architecture Culture, September 1960: Sho-koku House.

International Architecture, April 1960: Bijyutsu Publishing House.

Paper in book with editor:

Kisho Kurokawa in: Architect Culture: Syo-koku Company. 1959.9 p.27-32.

Kisho Kurokawa in: Modern Architect: Modern Architect Company. 1961.3 p77-81.

Website:

<http://www.rhino3d.com/new/dev> (accessed 01.11.2016)

<http://www.data.jma.go.jp/obd/stats/data/bosai/report/1959/19590926/19590926.html> (13.10.2016)

<http://www.kisho.co.jp/page/11.html> (accessed 23.09.2016)

Visual Communication in Architecture – When an Image Becomes Reality

Introduction The Reality of Architecture

Visual communication is a way of communicating through visual aids, meaning it relies exclusively on vision, mostly through two-dimensional images. Architecture is one among many professions that use primarily visual imagery to communicate amongst professionals but also with lay people. Recently, more significance is placed on the later, and communities are getting more involved. To many professionals this is a matter of high importance. 1 By analyzing images presented to community, lay people make their own judgments on whether the proposed designs or plans are good or bad. Considering they were given a voice, certainly their opinion should count, but the question which naturally presents itself is - how do architects as professionals communicate with communities? Does this communication differ from communication amongst themselves? Furthermore, and possibly one of the most important issues is the following question: can this imagery used as communication tool also be used to manipulate and deceive the general public? Nada Bates-Brkljac points out that “professional ‘jargons’, including architectural, are often criticized as mystifying, whose main purpose is to exclude outsiders.”², which proves that there is a difference in presentation within the profession and towards lay people.

However, could this be said about any profession then? Is the general public also concerned about, for example, medical language? It is clear that architects don’t, and there is no need even to present detailed plan drawings, technical sections etc. to a community due to fact that it would probably not be understood. Usually some form of a perspective view is presented, which can be better understood. With technology advancing almost on a daily basis, projects presented over time have become more and more real, and in what seems like blink of an eye, we are now surrounded by images so real that it is hard to tell if it is a computer rendering or a photograph.

¹ *Community Involvement in Planning: The Government’s Objectives*. ODPM. Office of the Deputy Prime Minister. London 2004

² Bates-Brkljac, Nada. *Towards client-focused architectural representations as a facilitator for improved design decision-making process*. <http://papers.cumincad.org/data/works/att/ddss2008-09.content.pdf> (accessed 17.3.2017).

Day by day, hand drawings, collages and similar forms have become things of the past, and pencils, glue and scissors have been replaced with mouse, digital pads and computer applications. Technology is more accessible and affordable than ever before, advancing so far that by putting on glasses, one can find themselves in virtual reality, walking around the cyber space, navigating through the non-existing and almost fully experiencing the “space”. Participants who are highly present should experience VR as a more engaging reality than the immediate world, 3 and as presence is the essence of a psychological experience⁴, virtual reality is taking form of “real reality”. Architecture, as a science and an art form, lived through many societal changes and revolutions, but where does it stand in this new renaissance of society? Can it follow as easily and quickly as changes appear?

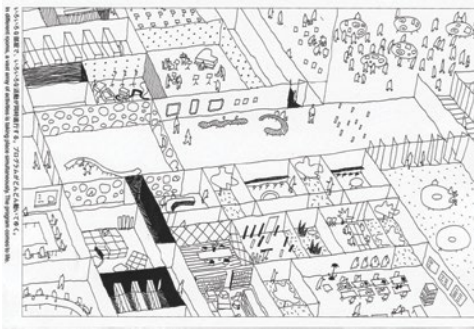

Fig. 01. SANAA architects –
Spatial Intentions Diagram

Source: <https://flickr.com/photos/references/5433493820>



Fig. 02. Studio BIG - St. Petersburg Pier,
Computer generated render

Source: <https://www.big.dk/#projects-spp>

Architecture Drawings Before Computer Era

Before approaching possible problems architecture might be facing today, it is important to understand that architecture communication has come a long way through history, it was changing and developing, as it is in human nature to search for more, and to explore new and better ways to deal with problems. From prehistoric times and cave paintings where possibly the first sections might have been drawn, through the full development of architecture as a profession in the ancient Greek times, we trace architecture drawings in a similar form as they are used now.

Architecture was communicated then and also now, through technical drawings which were subject to certain norms that made them understandable to audience regardless of differences in verbal communication. Nevertheless, there was more to art of drawing in architecture. Pre-design phase includes diagrams

³ Balakrishnan, Bimal; Kalisperis, Loukas; Sundar, Shyam. *Capturing Affect in Architectural Visualization - A Case for integrating 3-dimensional visualization and psychophysiology*. http://papers.cumincad.org/data/works/att/2006_664.content.pdf (accessed 22.4.2017).

⁴ Huang, MP; Alessi NE. “Presence as an emotional experience” in J.D. Westwood, R.A. Robb and D.Stredney (eds), *Medicine meets virtual reality: The convergence of physical and informational technologies options for a new era in healthcare*, Amsterdam. 1999. p. 148-153.

and sketches, while post-design phase brought need to visualize subjects before their materialization, which introduced perspective drawings and different images simulating atmosphere in space. Drawing is the key to synthesizing the vision of an architectural idea concisely ⁵ and it was changing and developing in search for better ways to envision ideas and thoughts. Even technical drawings were adapting and evolving through history in order to communicate better. Changing the norm to express a project in the best manner is visible for example in Jeremy Bantham's drawings of a design for Panopticon Prison, where the architect combined plan, section and elevation in one image, creating a harmonious and clear image of how the design functions.



Fig. 03. Two men under a tent, Prehistoric Indian cave painting, 7,000 years ago

Source: architectural-review.com/today/14-pivotal-architecture-drawings/8657619.article

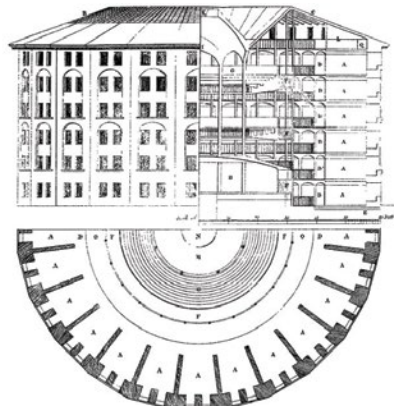

Fig. 04. Jeremy Bantham – Panopticon Prison Drawing

Source: theguardian.com/technology/2015/jul/23/panopticon-digital-surveillance-jeremy-bentham

At the same time the need for visualizing architecture appeared, non-existing structures started frequently appearing in art. However, architecture became a topic in itself as early as the 18th century. It was no longer about building the design, and it had introduced abstract thinking and research. It can be seen in the 18th century in Piranesi's Prison Series, where architecture becomes more abstract, less concerned with the technical aspect, creating a unique atmosphere, and his perspective images served as an inspiration rather than design waiting to be built. The end of the 19th century and the 20th century brought a new renaissance and changed architecture and the way it is communicated and perceived. Rejection of historical styles meant introducing a new set of rules, not only in design but also in the way of communication. The second half of the 20th century, up until the 1990s, is an especially prolific time in architecture and architecture drawing. Radical Italian groups Superstudio and Archizoom Associati, formed in 1966 in Italy, reshaped the architectural thought and society, influencing works of many contemporary architects today such as Rem Koolhaas or Zaha Hadid. Using

⁵ Scheer, David R. *The death of drawing: architecture in the age of simulation*. London: Routledge, 2014.

collage techniques, they created mega-structures which were never to be built but just served as a commentary on society and malfunction of architecture itself.⁶ Images created by Superstudio, although highly unrealistic and avant-garde for that time, created a certain desired atmosphere and a will to explore the thought of abstract thinking.

Just a decade later, Zaha Hadid won the competition for the Hong Kong Peak Leisure Club, presenting the mega-structure with oil on canvas, where the reference to Italian radical movement or Russian avant-garde is undeniable. Sam Jacob in his article about the lost art of architecture drawing speaks about these so-called paper architects of the 1970s and '80s: pre-commercial Libeskind, phase one OMA, and most of all, pre-digital Zaha Hadid - and many more. Drawings were indivisible from disciplinary conception of architecture. These were drawings not of architecture but as architecture.⁷

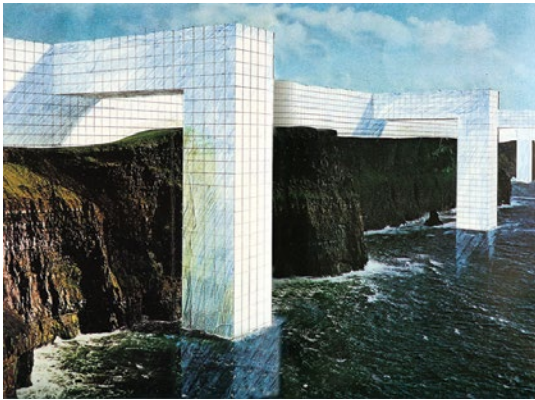

Fig.05. (Above) Superstudio - Continuous Monument
Source: socks-studio.com/2011/03/02/superstudio-italian-radical-architects/



Fig. 06. (Right) Zaha Hadid - The Peak Leisure Club project,
oil on canvas, 1982
Source: zaha-hadid.com/architecture/the-peak-leisure-club/

Introduction of CAD and BIM - Death of Drawing

With technological revolution in the 1960s and the 1970s, the world started to change. Computers were introduced to help solve problems, and in minutes or hours they were able to do something that could take days for a team of people. While technology and computers were slowly entering all pores of the society, architecture was not left out. In the 1970s, the first CAD programs were introduced, and they were to help designers and building professionals to draw and

⁶ Ringen, Jonathan. *Superstudio: Pioneers of Conceptual Architecture*. <http://www.metropolismag.com/December-1969/Superstudio-Pioneers-of-Conceptual-Architecture/> (accessed 15.3.2017).

⁷ Jacob, Sam. *Architecture Enters the Age of Post-Digital Drawing*. <http://www.metropolismag.com/architecture/architecture-enters-age-post-digital-drawing/> (accessed 24.3.2017).

solve problems. Following introduction of CAD, the concept of BIM was created. Computer programs have quickly taken design and building world by storm, finding broad usage and replacing drawing boards and physical model making. Drawing and designing became easier and faster, changes in projects and designs that could previously mean extending deadlines for days and weeks became problems resolved in minutes. BIM was the potential tool that could radically transform the design process and change the rules of traditional architectural conventions of visual communication.⁸ BIM offers the double-edged promise of displacing abstraction with simulation.⁹ The art of drawing was getting lost, and many architects of the young generation are not even familiar with practices that were once used. Architect David Ross Scheer, in his publication *Death of Drawing : Architecture in the Age of Simulation*¹⁰, discusses the importance of drawing in the process of design. At first glance, an architect declaring the death of drawing might seem shocking and questionable, as drawing is perceived as the most fundamental medium of communication, it is the hallmark of an architect's profession. The author does not negate the positive side of technology and the help it provides; he says we need to understand the myriad of tools available to us, but be smart enough to lead with design rather than performance. Architects need to talk back to BIM and preside over the course of design. Scheer made substantial efforts in elaborating on two key concepts here: representation and simulation, which he believed differ from each other significantly. Scheer criticized representation for its intrinsic inadequacy and inaccuracy in reflecting reality, despite its symbolic role in architectural practice, and exploration of representations does lead to advancement of knowledge about reality. Simulation on the other hand, is the operational reality at the cost of reduced complexity. Thus it helps us gain insights to limited reality in an experiential manner without concern about interpretation. The central argument raised by Scheer was: *"...the relationship between design and reality is undergoing a shift from representation to simulation and that this shift has many profound implications for architecture."* Scheer expressed concerns about the radical change caused by the displacement of drawing by simulation, featuring BIM and computational design, and fears that such change was largely attributed to performative economic reasons. What does being able to do more and produce faster mean for the architectural profession? Is architecture becoming a 'toy' of other professions, such as real-estate, doing fast design, producing technology-helped glossy images and visualizations, more as marketing tool than representation of project itself?

⁸ Ambrose, Michael. *Plan is dead: To BIM, or not to BIM, That Is The Question*. http://papers.cumincad.org/data/works/att/ascaad2006_paper13.content.pdf (accessed 17.3.2017).

⁹ Ambrose, Michael. *Plan is dead: To BIM, or not to BIM, That Is The Question*. http://papers.cumincad.org/data/works/att/ascaad2006_paper13.content.pdf (accessed 17.3.2017).

¹⁰ Scheer, David R. *The death of drawing: architecture in the age of simulation*. London: Routledge. 2014.



Fig.07. Architecture renderings on banners, new investment in Lodz, 28.04.2017.

Source: photograph by Antonio Nevescanin

Architecture Representations

Throughout design decision-making process, people's understanding and assessment of design proposals is facilitated by architectural representations. Visual representations that are commonly presented to the general public nowadays are mostly architecture renderings, 3D visualizations of upcoming projects. By looking at visual representations, people make apt judgments on whether a building, housing estate, a city centre design scheme, etc., is 'good', 'bad' and whether we ourselves 'like it'. Thus, the processes cannot overlook the key role visual representations play, not just in deciding the worth of design proposals but also in actually determining what gets built. 11 A research study done at the University of the West of England (UWE) in Bristol investigated peoples' perceptions and responses to different forms of architectural representations of urban development proposals. The investigation revealed that:

- a. There is an inadequate consideration of what type of architectural representation is appropriate at specific stages and its purposes within the design decision-making process
- b. There are significant differences between the experts' and non-experts' responses to different forms of architectural representations that need to be further explored following the increased public participation in the process.

What do these findings mean for architects? Even more importantly – what do they mean for architects in training, the ones that are to carry out the profession in the future? Architects are relying more and more on computer tools to create representations of their work, the market is getting competitive on realness of rendered images, all to win over the general public, competition or investor. It is understandable that 3D images and visualizations are easier to read and process, and are therefore possibly the best way for presentation. But is the computerization of architecture erasing essential tools like sketching and drawing, and therefore trivializing the profession, thus allowing bad

¹¹ Bates-Brkljac, Nada. *Towards client-focused architectural representations as a facilitator for improved design decision-making process*. <http://papers.cumincad.org/data/works/att/ddss2008-09.content.pdf> (accessed 17.3.2017).

designs to be built? There needs to be established connection between the architecture design process and representation in different stages of process. As professionals, architects should come to term with what kind of presentations are acceptable in architecture society, and more importantly to lay people, and what percentage of work and in which stages should work be done using IT methods. Once general public is presented with images too polished and almost ‘too real’, their expectations grow, and professionals are finding themselves in competition to create images, instead of spending time in design process. Architecture becomes just a manipulation tool in real-estate marketing and loses its ethical root usually for financial profit.



Fig. 08. ‘Apartments inspired by your dreams’ photograph, Lodz, 28.04.2017

Source: photograph by Antonio Nevescanin



Fig. 09. MVRDV - Ravel Plaza Project, architecture rendering

Source: dezeen.com/2015/10/09/mvrdv-plant-covered-proposal-wins-ravel-plaza-amsterdam-competition/

Hyperrealism in Architecture Visualizations

Daniel Boorstin in his book “The Image: A Guide to Pseudo-Events in America”¹² writes that we are living in a world in which fantasy is more real than reality. He describes how the forged and unauthentic displaces the natural, true and spontaneous. In fact, reality and life become forms of art or entertainment, like television, movies and the radio. In this context, the question arises: what is the association between reality and its representation.¹³ Recent discussion raised by a project of Dutch office MVRDV is just one example of problems architecture deals with in modern society nowadays, and exploration of fantasy world and reality which Boorstin questioned in 1987.

Even before construction of the design started, the project for Ravel Plaza in Amsterdam has raised controversy. In his article ‘What this MVRDV Rendering Says

¹² Boorstin, Daniel J. *The image: A guide to pseudo-events in America*. New York: Atheneum, 1987.

¹³ Asanowicz, Alexander. *Computer Renderings - “Reality is Overrated”*. http://papers.cumincad.org/data/works/att/2005_729.content.pdf (accessed 13.4.2017).

About Architecture and the Media¹⁴ architecture writer Mark Minkjan raised questions about architecture representation and problems with creating and communicating through renderings. Minkjan points out why renderings of Ravel Plaza are misleading and appear to be fantasy-like in their hyperrealist appearance. “*Is architecture today anything more than make-up for real estate projects?*” wonders Minkjan in the article, expressing the worrying reality taking over the architecture profession. He does state though, that he does not question the future look and functionality of the building, which is not a part of the presentation once it is built. He just perceives the language and communication as the problem. A problem where architects voluntarily agree to ‘reduce architecture to cosmetics’, hiding the ugly side of architecture and urban development, manipulating the public, and working hand in hand with investors and real estate in flipping the plots and creating money, not thinking about creating better architecture or trying to speak up about the problem. Architecture with these representations is associated with luxury and exclusivity, instead of everyday social and public issues, according to Minkjan. Also, the media adds to the frenzy, presenting visualizations, glorifying this way of communication and imposing standards to the architecture professional market. It is almost unthinkable to deliver an architecture competition, regardless of the topic, without 3D computer generated visualizations, which are getting better, ‘more realistic’ - with more flying birds and trees in the background, that will probably not appear there in the end, and no one will care anymore. In his publication *Visual communication: images with messages*¹⁵ Paul Martin Lester discusses how society is bombarded on a daily basis with unrelenting stream of visual stimulation from all forms of media. Society learned to respond to images, read them quicker than any other information. Is one computer generated image enough to win the competition, to build the project, to warm the hearts of the general public? In the paper *Communicating with laypeople*¹⁶, Hornyanszky-Dalholm and Rydberg-Mitchell explored different techniques of communication with the lay people, and already in 1992 when the paper was published, they expressed concern about using computer techniques in communication with lay people. They point out that ‘...beautiful pictures could make them [lay people] believe that they [architects] are more committed to the users than when using traditional tools’. They suggested that the physical model is a much better way to communicate the idea and concept. However, now in 2017 architects rarely build models. Often, architecture practices that can afford it pay graphic design studios to create renderings for them. On a highly competitive market, and because of the fast pace of living and the way we process information, it can often happen that a ‘better’ image wins, which means that market is reserved for those with the resources and money to create these images, and the ones who are willing to play this game. After Minkjan’s article, influential and well

¹⁴ Minkjan, Mark. *What this MVRDV Rendering Says About Architecture and Media*. <https://www.failedarchitecture.com/what-this-mvrdv-rendering-says-about-architecture-and-media/> (accessed 22.3.2017).

¹⁵ Lester, Paul Martin. *Visual communication: images with messages*. Belmont, CA: Wadsworth Pub. Co. 1995. p.7

¹⁶ Hornyanszky Dalholm, Elisabeth. *Communicating with Laypeople*. <http://papers.cumincad.org/data/works/att/7bf4.content.01203.pdf> (accessed 13.4.2017).

known architecture practice MVRDV sent an open letter¹⁷ to Archdaily, stating that “*MVRDV accepted grudgingly to have a visualization department because renders are used as a translation of the architect’s core business, the technical drawing, to make the building understandable to clients and users—not to mention the fact that most newspapers would never publish a technical drawing.*” While Ravel Plaza might look stunning once built, is this the case for all projects presented through hyperrealist visualizations? Another question is, if we as architects can understand and agree that pressure of creating ‘perfect’ rendering and manipulation that goes with it is not the best way to communicate, why do we accept this way of communicating and working? Why can’t resources be spend on improving the design process?

Conclusion

We are living in a world where dream of an architect easily becomes reality. Something that is today just a two-dimensional image on the computer screen can tomorrow become a three-dimensional structure in our neighborhood. While hand drawing, collage techniques and making physical models are becoming things of the past, technology steps in, providing faster, easier and more realistic solution for creating imagery to communicate. The bar is being raised on a daily basis, while we are surrounded by more and more realistic virtual images of the world around us, sometimes so romanticized that the actual reality cannot live up to expectations. Technology is taken so far that computer systems can actually design instead of people, resolving more and more complex problems. Architecture becomes marketing where the best presented image wins, being consumed as fast as any product on the market. We are surrounded by computer renderings as they appear everywhere, even on billboards of new investments, construction sites etc. In need of a fast solution, actual architecture design in society often takes less time than producing the perfect renderings, and it becomes less important. Lay people have more insight in architecture than ever before, as they became consumers of images and renderings. The architecture profession itself is divided – the ones who are accepting the present and producing the imagery as expected, raising the expectations on daily basis, and on the other hand, the ones still trying to resist, understanding the importance of drawing and the process of thought put into it. Simply based on the projects and designs can it be possible to establish the criteria to evaluate the quality of both approaches and designs? Furthermore, what are the consequences once an image that became reality does not live to expectations?

¹⁷ Davidson, Alex; Knikker , Jan. *In Defense of Renders and Trees On Top of Skyscraper*. <http://www.archdaily.com/783045/in-defense-of-renders-and-trees-on-top-of-skyscrapers-mvrdrv> (accessed 22.3.2017).

Bibliography

Books:

- Boorstin, Daniel J. *The image: A guide to pseudo-events in America*. New York: Atheneum, 1987.
- Curtis, William J. R. *Modern Architecture since 1900*. 3rd ed. London: Phaidon, 1996.
- Jodidio, Philip; Zaha Hadid. *Hadid: Zaha Hadid, Complete Works 1979-today*. Koln: Taschen, 2013.
- Scheer, David R. *The death of drawing: architecture in the age of simulation*. London: Routledge. 2014.

Publications and documents without author:

- Community Involvement in Planning: The Government's Objectives*. ODPM. Office of the Deputy Prime Minister. London 2004

Paper in book with editor:

- Huang, MP; Alessi NE. "Presence as an emotional experience" in J.D. Westwood, R.A. Robb and D.Stredney (eds), *Medicine meets virtual reality: The convergence of physical and informational technologies options for a new era in healthcare*, Amsterdam. 1999. p. 148-153.

Website:

- Ambrose, Michael. *Plan is dead: To BIM, or not to BIM, That Is The Question*. http://papers.cumincad.org/data/works/att/ascaad2006_paper13.content.pdf (accessed 17.3.2017).
- Asanowicz, Alexander. *Computer Renderings - "Reality is Overrated"*. http://papers.cumincad.org/data/works/att/2005_729.content.pdf (accessed 13.4.2017).
- Astbury, Jon. *14 Pivotal Architecture Drawings*. <https://www.architectural-review.com/today/14-pivotal-architecture-drawings/8657619.article> (accessed: 19.12.2016).
- Balakrishnan, Bimal; Kalisperis, Loukas; Sundar, Shyam. *Capturing Affect in Architectural Visualization - A Case for integrating 3-dimensional visualization and psychophysiology*. http://papers.cumincad.org/data/works/att/2006_664.content.pdf (accessed 22.4.2017).
- Bates-Brkljac, Nada. *Towards client-focused architectural representations as a facilitator for improved design decision-making process*. <http://papers.cumincad.org/data/works/att/ddss2008-09.content.pdf> (accessed 17.3.2017).
- Budin, Jeremiah; Rosenberg, Zoe; Syrkett, Asad. *Architectural Renderings Are Probably Lying to You - Don't trust the renderings*. <http://www.curbed.com/2016/3/31/11333854/alexandra-lange-curbed-appeal-podcast-renderings> (accessed 19.12.2016).

- Davidson, Alex; Knikker, Jan. *In Defense of Renders and Trees On Top of Skyscraper*.
<http://www.archdaily.com/783045/in-defense-of-renders-and-trees-on-top-of-skyscrapers-mvrdv> (accessed 22.3.2017).
- Hornyszky Dalholm, Elisabeth. *Communicating with Laypeople*. <http://papers.cumincad.org/data/works/att/7bf4.content.01203.pdf> (accessed 13.4.2017).
- Jacob, Sam. *Architecture Enters the Age of Post-Digital Drawing*. <http://www.metropolismag.com/architecture/architecture-enters-age-post-digital-drawing/> (accessed 24.3.2017).
- Minkjan, Mark. *What this MVRDV Rendering Says About Architecture and Media*. <https://www.failedarchitecture.com/what-this-mvrdv-rendering-says-about-architecture-and-media/> (accessed 22.3.2017).
- Ringen, Jonathan. *Superstudio: Pioneers of Conceptual Architecture*. <http://www.metropolismag.com/December-1969/Superstudio-Pioneers-of-Conceptual-Architecture/> (accessed 15.3.2017).

Aero-Architecture “Visualizing to 2nd life of Commercial Airliners” – Recommissioning, Reclaiming, Redesigning Commercial Airliners into Resilient Spaces

Introduction

Hidden and forgotten in the southwest deserts of the United States, away from public view and discourse, are the anonymous airplane graveyards, with their expanding area and ever-growing numbers of obsolete airplanes dating back to the Second World War. The once majestic and most advanced technological inventions of mankind are discarded to decades of slow erosion by the sun and the wind. Last year, an interesting article titled “The Boneyard – Old jets are retired to the New Mexico desert” appeared in the 05/13/16 issue of USA Today by journalist Ben Mutzabaugh in which he eloquently describes the boneyard adjacent to the Roswell local airport. The article presents an exhibit of retired airplanes from the Boeing 777 to the 727 and other planes, like “the red 1962 Lockheed Jet Star JT 12-5 that once flew Elvis”. Ben continues to describe the site as a popular tourist destination for observing the decaying and exposed airplanes as an airplane cemetery museum that brings back “lot of memories” of our aviation history. For architects, this junkyard is an untapped resource ready to be reshaped, reused, and brought back to life. A potential refuge, a new line of furniture, a new housing typology, and many other visions are possible second lives to be created from these obsolete airliners.

It has also been 15 years since Architect William McDonough’s visionary book “Cradle to Cradle” introduced a new model and approach to existing manufacturing and design. He produced the Hanover Principles, “a set of statements about designing buildings and objects with forethought about their environmental impact, their effect on the sustainability of growth, and their overall impact on society”. Professor Paul Laseau’s books, “Visual Notes” and “Architectural Drawing”, on visual thinking, studies the subject of visual acuity, the ability to see more in what we experience or observe, and the methodology to integrate that process clearly and accurately for others to understand. So the process and value of reusing and recycling become important components in architecture as we design new environments, in combination with our ability to visualize and communicate these concepts. Also embedded in this sustainable second life concept is another challenge: resiliency.

Excessively violent storms are becoming a more frequent occurrence in our weather patterns, and our architecture is not up to the task of combating their damaging forces. Buildings are swept away in floods and hurricanes, blown apart in tornadoes and straight winds, crumbled by earthquakes, and torched in forest fires. Resilient architecture needs to be investigated, created, and built in order to live safely in our climate-change environment.

These are the two challenges that have been the mainstay of the Aero-Architecture studios conducted at Ball State University's College of Architecture and Planning. The studios were able to build a design vocabulary of using airline parts as primary building materials in creating innovative and resilient architectural spaces, and finding a variety of reuses for these forgotten airliners. The resultant student projects were first informally introduced to a group of young aeronautical engineers working at Boeing, as well as the chief engineer of the 747- 800. They encouraged us in the continuation of these projects, and invited our students to visit the assembly plant in Everett, Washington, where they were introduced to aero technology, airplane components, assembly logistics, new materials, and integral design methodologies. The plant tour also allowed students to see the process of manufacturing commercial airliners, and gave them close-up opportunities to examine the scale of the components that make up the aircraft.

The paper will present five years of aero-architecture through graphic communications of the graduate studios that utilized the airplane bone yards to reinvent the obsolete into state-of-the-art living environments and create a second life for the Boeing Commercial Airliners. The communication challenges were to illustrate the continuous value of aeronautical engineering, to demonstrate the endless opportunities of the second life of airplanes, and to visually address the resilient challenges of future climate-change environments.

The Studio Brief

The architecture graduate studio design challenge was to invent a second life for the Boeing Commercial Airliners. The studio engaged in the challenge to program, develop and design contemporary sustainable habitats by utilizing the components of the decommissioned commercial airliners as primary material for the projects.

The Program

The design studio began with a visit, via Google, to airline graveyards in Arizona, during which they investigated particular models and then reinvented the obsolete into state of the art habitats and created a second life for the Boeing Commercial airliners. The challenge was to define and redefine these once majestic ships of the sky and transform them into sustainable living spaces on earth. The projects began in the research stage (team process), with the analysis and the investigation of airplanes, and terminated with individual design solution of architectural form, space, and technology.

The other design research component was the analysis and understanding of extreme weather patterns, environmental forces and the destructive effect they have on architecture.



Fig. 01. Airplane Boneyards, Source: Google

The First Project

The first project was to utilize, reinvent, and reform the fuselage into a new urban architectural environment, integrated with layers of sustainable architectural concepts for contemporary urban living patterns of working, living and playing. These projects were then presented and critiqued by Aeronautical engineers at the Boeing Assembly Plant and in the Future of Flight Museum in Everett, Washington.

The studio then received a plant tour in order to gain more understanding of the scale, technology, and assembly of the planes for their second studio project. (Plant photographs by Boeing) The tour allowed students to see the process of manufacturing commercial airliners, and gave them up-close opportunities to examine the components that make up the aircraft.

The Second Project

The second project is to respond to the gained knowledge and experience of the tour and engagement from the Boeing Plant visit and the Boeing presentation and discourse. Student then design more integrated systems of the utilization of airplane components.

Below are a few examples of the students’ projects and the added value they incorporated into their designs.



Fig. 02. Proposed disassembly plant and design studios

Source: author

Aeronautical Disassembly and Research Facility by Joshua Stowers

Have you ever wondered what happens to a retired aircraft, especially the commercial airliners? Well, many end up in the desert, useless and abandoned. But why? Few facilities exist to disassemble an aircraft, but those that do rip and shred the airplane into useless chunks of scrap material. Why not recycle parts just the way they are?

Commercial airliners are assembled similarly to cars, right on an assembly line, albeit a slightly bigger one. With all their pre-made component technologies integrated into the construction of an aircraft, why not simply reverse-construct the plane? The Aircraft Fleet Recycling Association has already set goals and standards for aircraft disassembly, but why not go further?

In business, money is everything, and an aircraft's scrap value alone does not justify the cost of cutting it apart. So how does one overcome this? By producing an environment that encourages the creative reuse of airplane parts and materials for manufacturing products and incorporating them into architectural design, decommissioned aircraft would have enough value to economically justify their disassembly.

A zero-waste disassembly plant would provide refurbished airworthy parts back to the airlines, provide raw materials for an on-site manufacturing facility, and ensure every scrap is recycled. Attached to the facility, an education, training, and research facility would incubate entrepreneurs, provide a platform of opportunity to researchers, and be the center of the discussion for spearheading efforts of sustainability after the useful life of aircraft.

By establishing added value to the process, this facility makes possible the tools, space, and leadership needed to create and establish new uses for aerospace technologies. The aim of this facility is to be a platform where all the other projects in this paper become possible, by providing the opportunity and means for their construction.

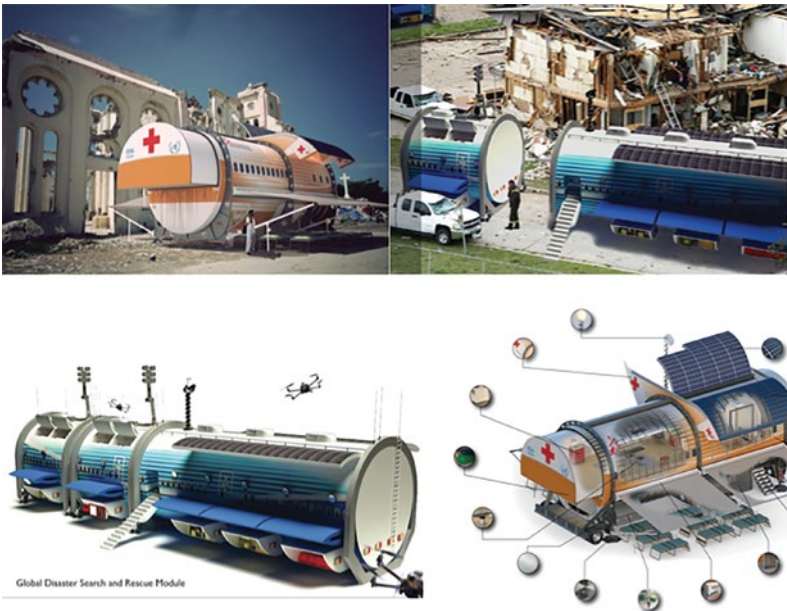

Fig. 03. A rescue and medical module, Source: author

Extreme Environmental Medical Response Module by Lucas Holwerda

Past research has shown that disaster response times and relief housing alleviate fears and concerns about safety and health in post disaster scenarios. While the relationship between housing and physical health has been the focus of considerable research, healthcare design and deployment—which are especially necessary in mitigating long term injury—have received much less attention. This study examines the issues of disaster response and deployment design through research of healthcare response in real disaster scenarios. I believe the findings will show that thoughtful design through empirical evidence, interviews, and working knowledge of healthcare programming can result in shorter response times and better health services immediately following catastrophes. In addition, only a handful of agencies currently have programs that target the health and security needs of disaster victims. This research suggests that there is a significant mismatch between healthcare knowledge and healthcare design response in disaster settings, which perhaps require exceptional response the most.

Utilizing case studies of organizations providing medical response in Haiti such as the United Nations Educational, Scientific and Cultural Organizations (UNESCO), The Red Cross, AmeriCares, and the United States Military, we can begin to gain insight into how response times for adequate medical care may affect social justice in post-disaster communities. In addition, a site visit to Haiti in March of 2013, three years following the earthquake disaster, provided opportunities of conducting observational research, as well as the implementation of interviews with local citizens and organizations such as the aforementioned case studies.

Through the use of Post Disaster Response Evaluations (PDREs) and literature reviews, policies and resulting designs appear, which inform how a responsive design may provide adequate medical response, and supports facilitating and alleviating concerns of inadequate social justice while generating a means of mitigating medical response that place citizens into categories (i.e., amputees) that root social stigma.

This design initiates the real-life concern that simply a quick response in catastrophic scenarios is not enough. An empirical approach towards medical response design, coupled with an understanding of local social belief systems, provides a framework for drastically improving the lives of the vulnerable stakeholders in disasters.

Global disaster search and rescue module by Daniel Potash

The Global Disaster Search and Rescue Module is a new alternative to traditional search and rescue operations. Utilizing existing aviation technology and products, these modules provide search and rescue teams with everything they need to operate in post-disaster situations. Due to the existing engineering capabilities, these modules are designed to withstand extreme conditions including the potential after-effects of a disaster. With the frequency of natural disasters increasing, these modules would be stationed around the world to be ready at a moment’s notice. The Global Disaster Search and Rescue Modules will make the jobs of rescuers easier, therefore saving more lives faster.



Fig. 04. Coastal resilient housing, Source: author

Aero BLOC, Resilient coastal housing, by David Smith

The Aero Bloc is a modular community, designed for a new breed of urban dweller. Recycled 737 fuselages provide the container for the modules, which can provide shelter for living, growing, retail, and many other uses including outdoor green space. Each module is designed to be entirely self-sufficient. Through the incorporation of efficient and smart systems the modules gather their own energy, collect water, and provide a dynamic pod for occupation. The entire complex grows organically based on need and input from the client and environment. Basic cellular rules for growth, architectural guidelines, and client needs determine the placement of the module in the Bloc.

The modules are prefabricated in a facility off-site, and delivered via barge or truck to the site. Before delivery the modules are completely finished according to client and engineering specifications, and upon arrival the integral crane automatically lifts the pod into place before a small team easily installs them into the superstructure. What is created is a complex network - a hive - of urban communal space. The superstructure provides a “quick connection,” or a port where the modules can be plugged in and unplugged easily. This design allows for the easy mobility, high quality

and efficient production, and flexibility of the structure. The pods are made to be able to be relocated if needed with simple means, and the 737-fuselage size allows it to be transported with most means.

The modular system and self-sufficiency also allow the Bloc to perform well in times of disaster. The Bloc is meant to resist the damages caused by flooding. The modules can be lifted to a higher placement as waters rise, and their on-board energy harvesting and water systems allow them to sustain themselves when infrastructure fails. The module itself is strong and resilient, and can resist the damages caused by high winds and water damage, and if the modules are damaged, they can easily be replicated and replaced.

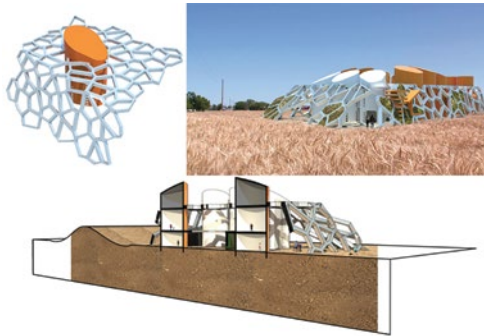

Fig. 05. Tornado responsive architecture

Source: author

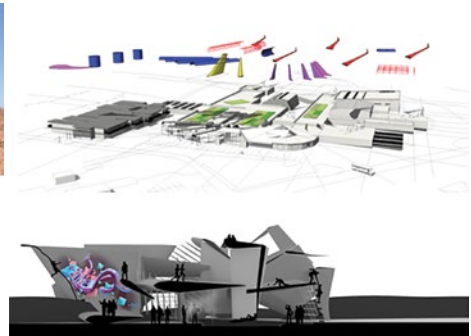

Fig. 06. Inserting and folding plane components

Source: author

Tornado Refuge by Glen Cramer

Every year, many people are killed or injured by tornados. Building collapse and flying debris are to blame. Suburban communities located in tornado alley are at a high risk of such destruction.

After being devastated multiple times in the past decade, Moore, Oklahoma is in desperate need of a stronger and more robust school to resist the next storm.

This school and community center sits next to a large suburban neighborhood with little or no protection. In the event of a likely storm this building will serve as a tornado shelter for those residents as well as a safe haven for the students and staff.

Inserting and folding of airplane components by Tara Murphy and Alexis Flowers

On March 2, 2012 an F3 tornado ripped through the small Indiana town of Henryville and destroyed their K-12 school. The storm caused considerable damage and left the educational facility in disrepair. The project inserts resilient airplane components into the redesign of the school that would create a more protective environment against future storms and create a unique educational environment.

By folding airplane parts, an exterior multi functional community facility is developed in an inner city neighborhood. The folded spatial composition allows for seasonal festivities, public markets, evening venues, and a variety public play.

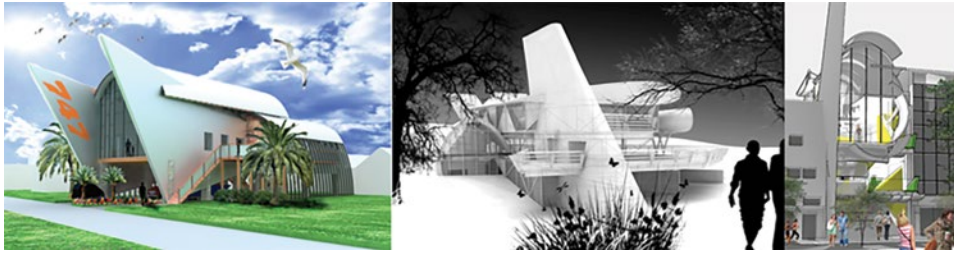

Fig. 07. Aero architecture housing
Source: author

Aero-Architecture Housing by Eric Bearman and Miguel Ramirez

New suburban and urban housing topology are designed by utilizing airplane parts in a variety of methods that result in more integrated systems and have the capacity to weather more violent storms. The parts of the fuselage will function as a safe room and the wings as a roof and water collection/storage system. The wings can also become aerodynamic structural walls to divert winds and collect energy. The concept is to convert a typical static house into a dynamic energy-producing facility for contemporary suburban and urban living environments.



Fig. 08. Fire resistance
Source: author

Fire Resistant Habitats by Morganne Walker

Wildfires, whether caused by nature or man, have destroyed millions of acres of forest, wildlife, and human dwellings and will continue on that path for years to come. This project looks into the possibility of being able to design a habitat that can survive a wildfire. By using the three-layered structure of the airplane engine as a main refuge against the heat of a forest fire and wrapping and extending the living unit with a sacrificial outer core of a recycled fuselage, one would be able to survive the fire and rebuild the dwelling after a major fire.

Embedded Things – an Inquiry into Beauty

In this paper I propose that slowness and nearness¹ should become crucial elements in developing an ethical, moral and aesthetic stance towards the environment. This kind of attitude is rooted in deep empathy rather than scientific understanding and an approach to “green building”, becomes embedded in us, ceases then to be a choice and becomes an unquestioned part of our value system.

Values, Ethics, and Beauty

“...the connection between an ecological perception of the world and corresponding behavior is not a logical but a psychological connection. Logic does not lead us from the fact that we are integral part of the web of life to certain norms of how we should live. However, if we have deep ecological awareness, or experience, of being a part of the web of life, then we will (as opposed to should) be inclined to care for all living nature. Indeed we can scarcely refrain from responding in this way.”
– “The Web of Life”; Fritjof Capra

In “The Web of Life” Fritjof Capra explores the ideas and beliefs brought up by the movement of Deep Ecology. He describes them as the view of the world, which puts the same value on the human and non-human life. It does not see hierarchies but networks in which all elements and phenomena of the world are fundamentally interconnected and interdependent. Deep Ecology questions the very foundations of our “modern, scientific, industrial, growth oriented, materialistic worldview and way of life”.² This means that our current paradigm is under question and paradigm shift is called for. The shift of the paradigm will happen when not only our opinions and perceptions change but also our values. Our value system governs our life and our every action. This change happens slowly and sometimes the process is almost imperceptible. For a paradigm shift we need a change in the value system from which a new ethics will emerge.

I believe that our ethics and our values are closely connected with what we find beautiful. We inherently want to preserve beautiful things (in museums), we want to be around them, we want interact (look at) with them. In western culture we associate

¹ In his essay “The Thing” Martin Heidegger explores nearness as an inherent aspect of “thinging” of things

² Capra, Fritjof, *The Web of Life* (Anchor Books, a Division of Random House, New York, 1996), 8

beauty and beautiful things with distance. We see ourselves as spectators removed from the engaged experience with the thing in order to appreciate it in an objective and “disinterested” way.

Crispin Sartwell describes art as the experience of full absorption into the world which stands in opposition to the attitude of “disinterested pleasure”. He says “to be a spectator is to be safe”³ but it does not reveal the beauty of the world to us.

I explore these concepts more in depth further in this paper in the discussion of making and its embodiment.

Sartwell explores other ways of conceiving beauty. One that seems very interesting to me is his examination of Hozho - Navajo’s concept of beauty. In contrast to the western way of understanding beauty hozho is not limited to aesthetics. It means “beauty” and “health”, “balance”, “harmony”, “goodness”. It describes people, things and the universe. Hozho describes everything and the interconnectedness of all. Similarly in Chinese culture and philosophy beauty is seen as moral, aesthetic, health and cosmos related. It is in processes and relationship of all things, it requires not looking but active participating which then becomes the way of knowing.⁴

“A single stalk of bamboo contains within it, and displays outwardly, the li of bamboo, the principle that distinguishes bamboo from all other things. And every stalk of bamboo also contains within it the li of the cosmos, the principle by which everything is ordered. Bamboo grows according to the nature of bamboo and has within it the genealogical heritage that distinguishes bamboo from all other plants. But each piece of bamboo also grows according to the conditions of its environment, according to the conditions of the earth, and according to the physical laws that govern the universe. It depends on the soil and weather, and climate, but also on gravity, energy and so on. In principle, a complete understanding of a stalk of bamboo entails and understanding of everything.” – Crispin Sartwell; “Six Names of Beauty”

Following this train of thought making is not mimicking but it is creating the world through responding to and participating in it.

I have been testing ways of instigating this change of values in both teaching my classes as well as in my own work. I believe that slow and deep engagement with the world could lead to building empathy which could then result in slow but enduring changes in value systems and in perception of beauty. I also believe that empathy cannot be taught but it has to be sensed and nurtured. The teacher can only open the space and opportunity for it to happen.

³ Sartwell, Crispin, *The Art of Living: Aesthetics of the Ordinary in World Spiritual Traditions* (State University of New York Press, Albany, 1995), 126

⁴ Sartwell, Crispin, *Six Names of Beauty* (Routledge, New York and London, 2006), 133 - 152

Things and Slowness

I would like to make two propositions and subsequently ask questions about them:

1. Re-presenting place as a process of making things is a way of creating a slow engagement with the place.
2. The deep, empathic relationship with the world can be built through this slow engagement with the site / place

In his essay “Bringing Things to Life: Creative Entanglements in a World of Materials” anthropologist Tim Ingold discusses things as they stand in opposition to objects. The inhabited world is comprised not of objects but of things. Things are not isolated and self-contained but they extend the possibilities and relationships into the world; a pen affords a possibility of writing, chair sitting, etc. Similarly there is not such concept as a tree but only “a-tree-in-the-air” with its particular location, relationship to the ground and the sky, insects and animals that live in and around it, wind, sun, and water. Ingold concludes that that “the tree is not an object at all, but a certain gathering together of the threads of life”.⁵

If we think of things as such gatherings then making of new things is a process in which one gathers and becomes directly engaged with the threads of life. In fact in that process the maker becomes a thread herself. The thing becomes a manifestation of the process of making / gathering but once the thing is made and becomes a part of the world exposed to all the physical and cultural elements the making continues, the making or rather the process of becoming of things never ends. It requires slow and enduring engagement to be noticed and understood.

For Ingold process of form giving is life, form is death. There is no such thing as static materiality, it is rather comprised of fluxes and flows of materials which come together to create things. The world and things are in the constant state of becoming.⁶

Slowness allows for the duration of time with the mind and the hands engaged with a particular place or aspect of the world. The mind is not charged with any specific goal or purpose, it is just there, it is lingering. It is immersed and soaked without being directed.

This is another way of describing Sartwell’s understanding of art as total absorption with the world. This is art and making as a way of knowing the world.⁷

Through my creative work and teaching I have come to understand the process of making as an embodied and tactile way of examining the world, as a way of dwelling in the world. I realized that this understanding requires making to be slow. Slow representing and making establishes a close, intimate and engaged relationship between the one who is making and the world.

⁵ Ingold, Tim, *Bringing Things to Life: Creative Entanglements in a World of Materials*, (ESRC National Center for Research Methods, July 2010), 4

⁶ See: Ingold, Tim, *Bringing Things to Life: Creative Entanglements in a World of Materials*

⁷ See: Sartwell, Crispin, *The Art of Living: Aesthetics of the Ordinary in World Spiritual Traditions*

Drawing; Freshmen Design Studio⁸

There is a series of projects conducted in the first semester of the first year architectural design studio. The objective is to develop a deep and empathic relationship between the student and the site (place / landscape) through making. In this paper I would like to focus on only one of the projects that the students embark on.

At the beginning of the semester the students draw a 1000' line on the map delineating the system of creeks and streams in our town. That line becomes their extended site, which they explore in the course of the semester. They document their extensive "being-in-the-site" and they start to look closer and at the same time beyond their immediate proximity. They look for patterns present on the site and they consider them as consequences of interactions and relationships - they understand the site as a system of extended forces. They record these forces directly on the site through rubbing, printing, casting, etc. The students are right there, in that place, touching the ground, dirt, grass, trees, submerging in the water, taking imprints of the physical world. They are as close to being enveloped in the heart of the site as possible. This nearness is one of the goals.

The students record one pattern at least three times – from the point of view of different forces responsible for creating it. They try to isolate each force but they soon find out that this is an impossible task as each force is entangled with all others and can only be revealed and described in its relationship to others. The physical and conceptual process that the students go through can be seen as stretching the place in different directions to be able to examine it from different points of view, while understanding that it can never be taken apart and reduced to individual element. The forces and patterns are always explored in their multiplicity. This is the first moment in which the smoothness of the place and its resistance to stratification reveals itself.

This duration and space of the place investigation is expanded and stretched.

"...material things, like people, are processes, and that their real agency lies precisely in the fact that 'they cannot always be captured and contained' (Pollard 2004: 60). As we have found, it is in the opposite of capture and containment, namely in discharge and leakage, that we discover the life of things."
– Tim Ingold; "Bringing Things to Life"

The recordings / drawings are **of** the site and place. They are not only the canvases for the forces and their relationships to manifest themselves. In order to "record" they have to, at least temporarily become parts of the site themselves. They become "entangled" with the site and they become things. They record (through touch, vision, sound, smell and taste) the process of becoming things.

⁸ The curriculum for this studio was a result of collaboration of four faculty members: Chere LeClair, John Brittingham, Mike Everts, and Zuzanna Karczewska

“The jug is not a vessel because it was made, rather, the jug had to be made because it is holding vessel ... The vessel’s thingness does not lie at all in the material of which it consists but in the void that holds.” – Martin Heidegger; “The Thing”

The thingness of the drawings is in the space between the actual artefacts and the site itself. That is the space of the process of making and revealing. That space is embedded in each student, a physical and inherent part of that process herself.

The students use the recordings to “reconstruct” the original pattern. They create large “slow” drawings that rebuild the stretched smooth and slow space of the place. Multiplicity of points of view, forces, and understandings are embedded in each drawing. The time that is taken for the drawings is the time of contemplation and reflection in which the empathy is built.

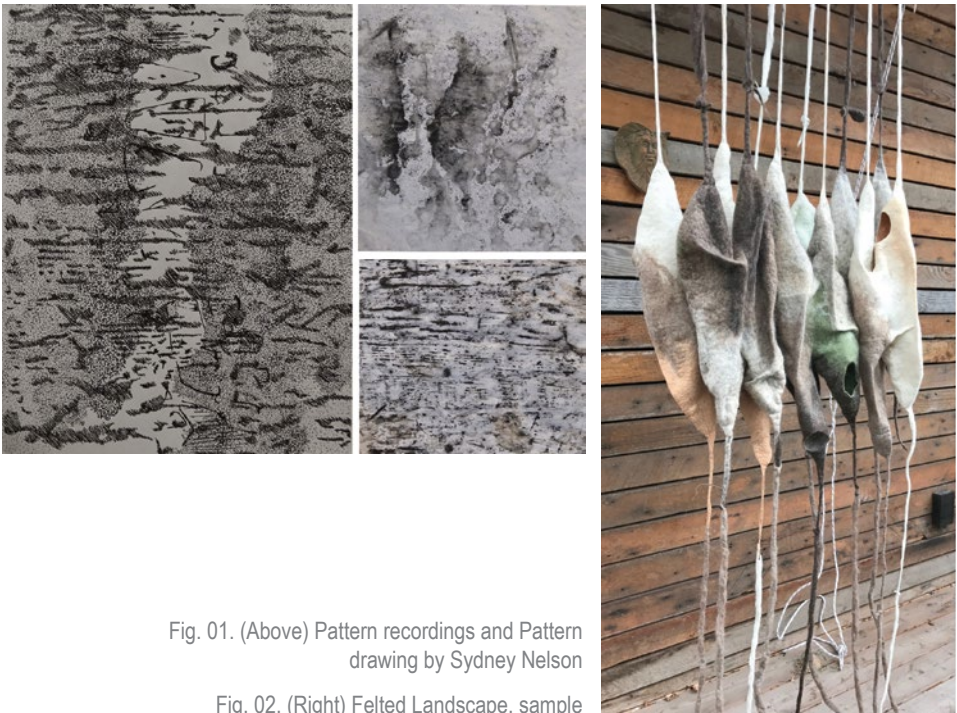

Fig. 01. (Above) Pattern recordings and Pattern drawing by Sydney Nelson

Fig. 02. (Right) Felted Landscape, sample

Felt

In “The Art of Living: Aesthetics of the Ordinary in World Spiritual Traditions” Crispin Sartwell argues that what defines art as art is the process of its production and the process of its receiving. Works of art are created for no other purpose except for their own sake and the most fundamental experience of that process is the experience of full absorption. The maker is immersed in the process of extracting the specific aspects of the world into the made or conceptualized thing and she is immersed in her relationship with the materials and stuffs of the world that she is working with - she is fully absorbed by the world itself. Conceived as full absorption, making becomes a way of not only interacting and participating in, but fully identifying with the world.

“distinction of an organism from the environment is itself only a convenience and is, in any case, fluid. We absorb parts of the environment into ourselves and we eliminate parts of ourselves into the environment. As we move through the environment the environment quite literally moves through us.” – Crispin Sartwell; “The Art of Living”

Art conceived as doing, making, and absorption is a way of knowing and being. In my work I explore the slow medium of felt which allows me to draw from the place, examine its “placesness” and learn how to dwell in it. Using local wool and plant dyes allows for the felted pieces to be **of the landscape** rather than just its representation. I am identifying the inherent qualities of the place (specific textures and coloration of the wool and the hidden color of the plants that change with seasons) within the made thing. Initially using photographs and observations in the landscape I bring the distinct layers of sky, ground and depths of the Earth into the “smooth” and “entangled” relationship in each piece, they are embedded within, and through the medium and action of felting they acquire their own energy.

“Felt, they say, is an antifabric “It implies no separation of threads, no intertwining, only an entanglement of fibers.” (Deleuze and Guattari) The ground of smooth space, likewise, is comprised of the entangled trajectories of growth and movements of people, animals and plants as they find a way through, following no predetermined direction but responding at every turn to the conditions of the moment and the possibilities they afford to carry on.” – Tim Ingold; “The Shape of the Land”



Fig. 03. Felted work, sample 02

Felt is 8,500 years old and felting is the oldest technique for producing fabric. It relies only on heat, moisture and pressure and does not require any other technology. The process itself builds on the specific characteristics of sheep’s wool - crimp, elasticity, and creep. With moisture the fibers swell and spread out their scales causing the fibers to entangle with each other. The heat, pressure and friction increase the crimp and creep causing the fibers to shrink with each other. The thickness, shape and size of felt changes in the process of making.⁹

⁹ Mullins, Willow, *Felt* (Berg, New York, 2009), 9

The process of felting is a way of creating the slow, empathic relationship with the place. In the process energy is exchanged between the felter's body and the thing itself. It is very tactile and physically engaging and it puts one in an intimate, overwhelming physical contact with the wool – its smell, texture and taste– which is a part of the place.

Felt has its own energies and there is always an unpredictable dimension to what is made. One is not fully in control. This unpredictable dimension of felt is dependent on the qualities of the local wool, its weight, texture, ability to hold water, which come directly from the place / landscape. It is also dependent on the environment – moisture in the air, temperature, etc.

In the process of felting wool, as wool-in-the-world – material in the constant state of flux, in response to its environment, becomes my body's extension into the world. Making, felting, dying are ways of knowing the world and place.

Conclusion

Opening up space for slowness is relatively straightforward in my own work. It is embedded in the process that I employ. There are several stages to felting each piece and each one of them is laborious and time consuming. It takes several days to complete each piece. There is a rhythm of intense physical making and reflecting – watching the wool dry. This is the rhythm of slowness and meditation. In freshmen studio, convincing students to take countless hours to complete a drawing so they can meditate on their relationship with the world is a different task all together. This kind of project is far from what they expect in their first semester of architectural education and they are often confused, frustrated and see it as a waste of time. However, in case of the students the value, in addition to slow engagement is also in tearing down their preconceived ideas on what architecture and architectural education is. Asking them to do a “slow” project at the very beginning of their studies requires them to rethink and questions values that they hold.

Bibliography

- Heiddeger, Martin. “The Thing” in *Poetry, Language, Thought*. Harpercollins. 2001.
- Sartwell, Crispin. *The Art of Living; Aesthetics of the Ordinary in World Spiritual Traditions*. Albany: State University of New York Press. 1995.
- Sartwell, Crispin. *Six Names of Beauty*. New York and London: Routledge. 2004.
- Mullins, Willow. *Felt*. New York: Berg. 2009
- Ingold, Tim. “The Shape of the Land” in *Making: Anthropology, Archaeology, Art and Architecture*. New York and London: Routledge. 2013
- Ingold, Tim. “Bringing Things to Life: Creative Entanglements in a World of Materials”. *ESRC National Center for Research Methods*. July 2010

The Intention behind the Spatial Representation of F.L. Wright's Wasmuth Portfolio

Introduction

For an architect, since the media age, it became crucial problem how to represent their works in two-dimensional plane especially to those who have not experienced their space in real life. In some cases, two-dimensional representations, free from the restrictions of reality, are better means to express architects' thoughts more clearly than the actual buildings, as Beatriz Colomina discussed the manipulation of architectural photographs by Le Corbusier as an issue of architectural spaces as mass media¹. This paper focuses on the drawings from *Ausgeführte Bauten und Entwürfe von Frank Lloyd Wright*, or so-called Wasmuth Portfolio, as an earlier example of the edited two-dimensional representations by an architect. Through the scrutinization of the intentional manipulations on drawings by Wright, this paper aims to study the reflection of his spatial ideas on drawings in comparison to his text.

The Selection of the Subject

Wasmuth Portfolio² consisted of two folios, which together contain a hundred loose leaves. It represented 65 projects, mostly in Prairie Style, between 1894 to 1909. It introduced Wright to Europe for the first time, is said to have given a strong impact on the European Modernist Architects who had never seen the actual buildings by Wright, through its innovative presentation³. Wright himself was deeply involved in the design and editing process of the portfolio, thus the presentation of the drawings

¹ Colomina, Beatriz. *Privacy and Publicity: Modern Architecture as Mass Media*. Cambridge: MIT Press. 1994.

² Since the original *Ausgeführte Bauten und Entwürfe von Frank Lloyd Wright* is scarce and not easily available, this research used the reproduction of the original, 2/3 of its size. Wright, Frank Lloyd. *Studies and Executed Buildings by Frank Lloyd Wright*. Ernst Wasmuth Verlag. 1998.

³ While it was widely believed that Wasmuth Portfolio accelerated the Modernism Movement in Europe, Anthony Alofsin argued that its influence was not as large as it has been conceived in his detailed study on Wright's European years. Nonetheless, Alofsin's claim does not undermine the importance of Wasmuth Portfolio in Wright's career and its powerful messages. Alofsin, Anthony. *Frank Lloyd Wright The Lost Years, 1910-1922*. Chicago – London / Austin: University of Chicago Press/ InnerformsLtd.com. 1993.

directly reflected his ideas. In spite of the publisher's wish to issue a photo book, Wright insisted on using drawings to represent his work. Though he was an amateur photographer himself, he was not satisfied with the quality of photographs. He claimed "Photographs do not adequately present these subjects. A building has a presence, as has a person, that defies the photographer..."⁴

Although Wright had a clear preference to drawings over the photographs, some of the eye-level perspective drawings are produced by tracing the photographs⁵ but with some alterations. Since the time to prepare for the publication was limited, tracing was a fast way to produce drawings, but another reason was to make adjustments how the buildings should appear according to his own vision, which may not have been expressed fully by the actual architecture. Wright was certainly conscious of how his works should appear in the media and manipulated them using the method that was available to him: drawing. This paper closely compares the perspective drawings with the original photographs, and clarifies the Wright's intended vision represented in two-dimensional media through the analysis of the reconstructed drawings.

Wright's Text

Two years prior to the Wasmuth publication, Wright had an opportunity to publish his works extensively in *the Architectural Record*, featuring 87 pieces of photographs and drawings as well as his manifesto, "In the Cause of Architecture"⁶. Wright, however, was not satisfied with the representation of his works in this issue. The portfolio was the another chance for him to visually represent his philosophy in the essay, "In the Cause of Architecture," as many of the drawings were tracing the photographs in *the Architectural Record*. He wrote in a letter to his friend in 1910, "The monograph (Wasmuth Portfolio) giving the office-ideal—the architect's rendering of his vision—his scheme graphically proposed in his own matter—"⁷,

In the essay, Wright emphasized the importance of "integrity" with Function and Form. Then, he formulated six prepositions that represented the architectural ideal not only for his own works but also for the entire architectural professions. Table 01. shows the main theme of the prepositions and key words. Especially the first and third prepositions gave concrete examples the design of architectural elements that could be represented through the drawings.

⁴ Wright, Frank Lloyd. "In the Cause of Architecture". *The Architectural Record*, Vol. 23. No. 3. 1908. 3. p. 159.

⁵ Brooks, H. Allen. "Frank Lloyd Wright and the Wasmuth Portfolio". *The Art Bulletin*. Vol. 48. No.2. 1966. p.193.

⁶ Wright, "In the Cause of Architecture". pp.

⁷ Wright's letter to Charles Robert Ashbee dated on July 24, 1910. Alofsin. p. 338.

Table 01. Six Propositions in "In the Cause of Architecture."

No.	Theme (Overall Theme: Integrity, Nature)
I.	Simplicity and Repose
	1. A building should contain as few rooms as the conditions allow.
	2. Openings should occur as integral features of structure and form.
	3. Less use of ornaments and decorations
	4. Assimilate appliances and fixtures into the design of structure.
	5. Picture should be incorporated in the general scheme of decoration.
	6. The furniture should be built in as a part of the whole building.
II.	A man had a right to his individuality through his house.
III.	A building should appear to grow from its site and harmonize with surroundings. i.e. gently sloping roofs, low proportions, quiet skylines, suppressed heavysset chimneys, sheltering overhangs, low terraces, outreaching walls sequestering private gardens
IV.	Use colour schemes to fit the nature.
V.	Bring out the nature of materials.
VI.	A house with character will be more valuable as it grows older.

Source: *The Architectural Record*. Vol.23. 1908. pp. XXX-XXX

Table 02. List of Drawings Produced by Tracing Photographs.

Pl. No.	Name of Buildings	Year	Int/ Ext	Source of Photograph
XXII	Bradley House	1900	Interior	The Architectural Record ¹ . p.180
XXIV	Hickox House	1900	Exterior	The Architectural Record. p.179
XIX	<u>Fricke House</u>	1902	Exterior	In the Nature of Materials ² . PL
XXXIII	Larkin Company	1903	Exterior	The Architectural Record. p.167
XXXIII	Larkin Company	1903	Exterior	The Architectural Record. p.173
XXXIII	Larkin Company	1903	Interior	The Architectural Record. p.169
XXXV	Tomek House	1905	Exterior	The Architectural Record. p.187
XXXI	Dana House	1904	Exterior	The Architectural Record. p.174
XXXIa	<u>Dana House</u>	1904	Exterior	The Architectural Record. p.175
XXXIb	<u>Dana House</u>	1904	Interior	The Architectural Record. p.174
XXVI	Barton House	1903	Exterior	The Architectural Record. p.206
LVI	<u>Coonley House</u>	1907	Interior	The Complete Works ³ . p.289
LVIa	<u>Coonley House</u>	1907	Interior	The Library of Congress ⁴

⁸ The Architectural Record, Vol. 23. No. 3. 1908. 3. pp. 155-221.

⁹ Hitchcock, Henry-Russel. In the Nature of Materials The Buildings of Frank Lloyd Wright 1887-1941. Trewin Copplestone Publishing Ltd. 1973.

¹⁰ Pfeiffer, Bruce Brooks; Goessel, Peter. Frank Lloyd Wright Complete Works 1885-1916. Taschen. 2011.

¹¹ Photocopy of Photograph, plate #121 Two Views: Detail of Rear and Interior, West Stairwell – Avery Coonley House, 300 Scottswood Road, 281, Bloomingbank Road, Riversice, Cook Country, IL, Prints & Photographs Online Catalogue, Library of Congress, USA.

The Selection of the Subject

Brook's paper lists 8 drawings, which were produced by tracing the photographs. In 100 leaves of Wasmuth Portfolio, there are 83 perspective drawings. 53 exterior and 6 interior perspective drawings have the standing point at eye-level. Among those 59 drawings, 38 depicted the realized buildings. After searching the photographs of those buildings taken before 1910 in the architectural magazines, 5 more photographs, used as the base image of the perspective drawings, were found, so the subjects of the analysis are 13 drawings (8 exterior and 5 interior drawings) in total (Table 02, the images not listed in Brook's paper are underlined).

Extraction and Analysis of the Altered Elements

13 drawings were superimposed onto the original photographs in order to clarify which elements Wright made alterations on the images of his design. The drawings, which were produced by tracing the photographs generally follow the overall angle of the photos, but many subtle modifications were made. The changes in each drawing were categorized into the 8 groups, and Table 03 shows the total sum of categorized alterations in 8 exterior drawings (Hickox, Fricke, Tomek, Dana, Martin and Larkin Company).

Analysis of the Altered Elements – Exterior Perspectives

As for the overall composition of the drawings, all exterior drawings have the layouts wider than the original photographs. The drawings are composed to be either square or landscape orientation, emphasizing the horizontality which is the characteristics of prairie and in accord with his Proposition III, "harmony with the surrounding Nature".

In the exterior drawings, the altered elements were categorized into three types, according to what they represent: architecture, natural vegetation, and surrounding environment. The "architecture" type had the most numbers of alterations, among which the wall fence, windows and eaves tend to be drawn differently from the original photographs. The wall fences are often newly added or stretched horizontally as the overall composition is widened. There are also cases where the heights of the walls are lowered, possibly in order to show more of the architecture behind. The windows are often stretched vertically or the decorations were added onto them.

Table 03. Categorized Changes in 8 Exterior Drawings

No.		1	2	3	4	5	6	7	8	Total	
Check Points		Newly Added	Deleted	Enlarged/ Emphasized	Reduced in size	Decoration Added	Design Change	Location Change	Angle/vanishing point change		
Overall	Vertical			3	1					4	
	Horizontal			8						8	
Elements	Architectural Elements	Window		2		5	3			10	
		Window frame			1			2		3	
		Column					1			1	
		Roof			2		1	1		2	6
		Eave			6	1				3	10
		Chimney			2	2			1		5
		Porch			3			3			6
		Fence Wall	4	1	3	3					11
		Fence		1	1						2
		Ground Fl.				1					1
	Bldg. Shadow	1	2				1			4	
	Natural Vegetation	Tall Tree	5	3	2	1		1	3		15
		Short Tree	3	4	1	1		1			10
		Leaf	5								5
		Branch		4							4
		Lawn	1			1			1		3
		Tree Shadow		4					1		5
		Flower Pot	1	1							2
		Plant on bldg.	4		2						6
	Surrounding Environment	Neighbor Bldg.(L)	4	4							8
		Neighbor Bldg.(R)	3	2		1					6
		Sidewalk	1					2	5		8
		Approach	3		1	1			1		6
		Topography			1			2	1		4
		People		2							2
		power pole,fire extinguisher		3							2
	Total		35	31	41	12	7	16	13	5	158

Source: *The Architectural Record*. Vol.23. 1908.

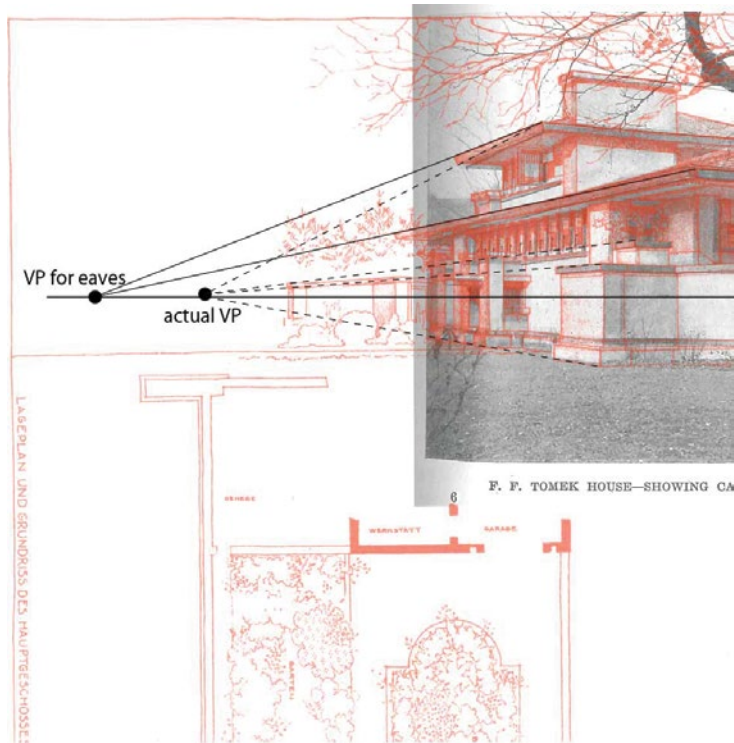

Fig. 01. Superimposition of Tomek House drawing onto the photograph.

Source: *Photograph-The Architectural Record Vol.23;*

Drawing Studies and Executed Buildings by Frank Lloyd Wright.

As in Proposition III, “gently sloping roofs” and “sheltering overhangs” achieved by eliminating attics were emphasized by stretching eaves horizontally. In some cases, Wright shifted the vanishing point of eaves more outwardly than that of the rest of the elements in order to emphasize the horizontality (Fig. 01). In the essay, he considered that such exterior appearance was the most radical break-off from the previous houses, and wished to emphasize it even more than how his actual works appeared.

The “natural vegetation” type had the second most alterations in the exterior perspective drawings. In many cases, trees were added behind the buildings to create more natural and lively atmosphere. While “Nature” was the element Wright repeatedly stressed in the essay, however, the Nature or surrounding environment he admired was not wild and untouched nature, but tamed and sophisticated one. Influenced by Japanese Woodcut Prints, notably Hiroshige, Wright adopted stylized representation of trees and leaves in order to create uniformity between architecture and Nature. The vegetation interfering with the buildings were intentionally removed or trimmed to show up the buildings, and the suburban landscape was more formal and trim than it actually was shown in the photographs. The plants on the buildings on the windowsill and balcony were often added or enlarged. The integration of vegetation with buildings was intentionally rendered, to make an emphasis on the Proposition III of “harmony with the surrounding Nature”.

Table 04. Categorized Changes in 4 Interior Drawings

No.	1	2	3	4	5	6	7	8	Total	
Check Points	Newly Added	Deleted	Enlarged/ Emphasized	Reduced in size	Decoration Added	Design Change	Location Change	Angle/vanishing point change		
Overall	Vertical		4					1	5	
	Horizontal		3	2					5	
Elements	Architectural Elements	Window,		1	1		1		3	
		Curtan, rail					2	2	4	
		Stairs	1				1	1	3	
		First floor					1		1	
		Beam, ceiling					2	1	1	4
		Bldg. shadow	1							1
		Door					1			1
		Material joint		1	2					2
	Furniture Elements	Desk	2							2
		Chair		1				1	4	6
		Carpet						3		3
		Fablic	4	1				1		6
		People		1						2
		Booshelf	4							4
		Desk Items	1					2		3
		Ornament	1	1	1			1		4
		Flower vase	6	3				1	1	11
		Flower pot		2	1					3
		Cushion		1					1	2
		Document	1	1						2
Total		21	12	12	3	7	12	8	2	77

Source: *The Architectural Record*. Vol.23. 1908.

Analysis of the Altered Elements – Interior Perspectives

Of 6 interior perspective drawings in the Portfolio, 5 of them were produced by tracing photographs. The drawings of Bradley and Coonley Houses living rooms and corridor have almost exactly the same composition as the photographs, while those of Larkin Company and Dana House boldly narrowed the composition of original photograph. For example, in the drawing of Dana House depicting the view of gallery through the stairway, the vertical composition was emphasized by adding the steps

which were trimmed off in original photograph (Fig. 02). Suggesting where the viewer stands, this pictorial manipulation and vertical composition helps to take viewers' eye into the depth of interior space.

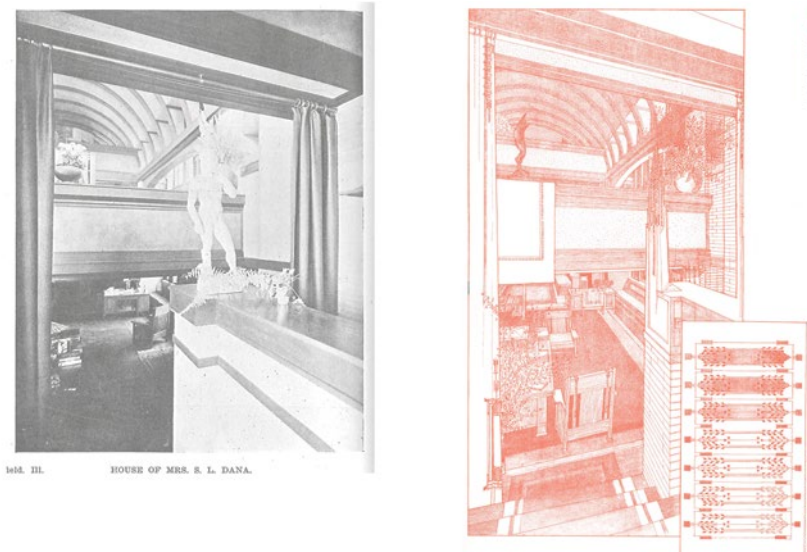

Fig. 02. Dana House photograph and drawing.

Source: *Photograph-The Architectural Record Vol.23*;
Drawing- Studies and Executed Buildings by Frank Lloyd Wright.

In the interior drawings, unlike the exterior perspectives, few architectural elements were altered while many furniture elements were manipulated by addition and deletion. As in Proposition I 3-6, Wright aimed to make harmonious interior with simple and geometrical furniture, but in actuality, many clients brought their own furniture against Wright's will. The drawings deleted and replaced those furniture with the ones designed by Wright.

The interior space in the drawings, however, are not just made simple by reducing the number of items, but Wright also added elements he designed. Especially, tapestries and bookshelves were often added. It shows that Wright considered not only architecture, but also those furniture elements to be important factors to create the uniform and harmonious atmosphere in the room.

Conclusion

In Wasmuth Portfolio, Wright attempted to visually represent the ideas in "In the Cause of Architecture" in the *Architectural Record* in 1908. One of the major reasons why Wright insisted on using drawings for the Portfolio was probably that he could treat "Studies (unrealized projects)" and "Executed Buildings" equally in order to achieve "integrity" of his thoughts and projects. Also, the act of tracing allowed him to select the elements that "he wished to see" from the photographic images and reconstruct the "Executed Buildings" to adjust to his vision. Drawing was the process to elevate the built projects to meta-architecture, or the integrated architectural idea, which was what Wright wished to present through the Wasmuth Portfolio.

Site-Sense

Introduction

The reading and understanding of ‘site’ is a fundamental component of an architect’s design process. The relationship between site and designer ultimately leads to the creation of the architectural proposal. A rich and thoughtful relationship with context can support the development of a unique, appropriate and relevant output.

Is it therefore appropriate to assume that learning how to develop this relationship is crucial to those engaged in the study of architecture, and if so how do we support students to acquire the skills to be able to fully and meaningfully engage with the ‘site survey’?

This paper explores the role of the site survey and reports on two diverse survey techniques and reflects on how the merging of these could form the development of a multi-dimensional methodology, which students can draw upon to aid their understanding and registration of place exploring the poetic, prosaic and the technics of the site. This proposal will challenge students to be scientists, urban archaeologists and anthropologists as they are tasked to engage with place beyond its surface and factual dimensions. The proposed tools are designed to support students to experiment with recordings of both the factual and the temporal qualities of the context under examination, using a plethora of instruments from smart phones, sketchbooks, and their own bodies, and are encouraged to engage with the pragmatics as well as the poetics of that place through a series of tasks which will be a combination of conceptual and rational. It is anticipated that a meaningful and confident approach to site analysis will support students in their design of proposals that are consequently intelligently and intrinsically connected to the place for which they have been proposed.

Ewing in her introduction in ‘Architecture and Field/Work’ describes the process ‘field/work may be seen as a form of critical realism’ and goes on to list the traditional components of the site survey process, ‘site visit, site survey, site analysis condition survey, setting out, snagging...’.¹

This may all sound reasonable but what is actually meant by tasks such as ‘site analysis’?

¹ Ewing, Suzanne; McGowan, Jeremie; Speed, Chris; Bernie, Victoria Clare. *Architecture and Field/Work*. London: Routledge. 2011.

As a counterpoint to this Butterworth in her essay ‘Of all we survey’² is critical of what she terms as the ‘conventional survey’ and goes on to suggest that ‘a genuine understanding of place entails making a personal commitment.’

What is meant by a conventional survey is unclear but Butterworth’s critique implies that she sees the gathering of pragmatic data to be in deficit in respect of a holistic reading of the site, and that a personal understanding that captures the temporal and poetic qualities is necessary.

We propose that an assured balance of both is absolutely crucial if one is to fully and holistically understand a place. Over time and with experience much of the experiential data will come with ease. Hawkes, in his book *The Environmental Imagination* discusses Zumthor’s work as being supported by the ‘security of memory and experience, one might call this ‘informed intuition’³. But to get to that level of critical observation and registration many years of practice and a sensitivity to place is necessary.

Our own observations, firstly as students of architecture, are that the ‘site analysis’ and what that meant in terms of activity was never made explicit to us. Generally, a design brief was issued, a site given and off you went to complete the ‘site survey’. This usually involved a camera, a tape measure and a sketchbook, but with no guidance or instruction about exactly what we should be recording or what to do with the gathered information. It was intuitive learning, which never received the same level of critique as the outcomes that were produced as a result.

And now, secondly as architectural educators, we are critical of the learning and teaching around this vital part of the process, observing that it is generally unstructured and often inadequate.

This paper explores the development of a proposed methodology, which aims to support new students of architecture through the elusive site survey and equip them with a range of tools to observe, record, register and communicate the multi layers of factual and experiential information gathered through this process.

What are we asking, or perhaps expecting from students when we send them out to site? Scratching the surface of the place is a good starting point, inhabiting, resting and registering the phenomena of the site seems an ideal place to begin.

“Observation is a dying art.”⁴

Kubrick’s statement proposes that the art of observation is in decline and as architectural educators his statement rings true.

Architectural students must not only learn to actively observe, but they must do this within a framework that will result in recordings of these observations

² Butterworth, Carolyn. “Of All We Survey” in: Littlefield, David; Lewis, Saskia. *Architectural Voices*. Chichester: Wiley. 2007. p. 148-151.

³ Dean, Hawkes. *The Environmental Imagination*. London: Routledge. 2008.

⁴ <https://www.goodreads.com/quotes/959635-observation-is-a-dying-art> (accessed 14.04.2017).

that have meaning, and which will in turn contribute to narratives and arguments in the development of design proposals. They must learn skills and develop the confidence to represent what they find through captured images, technical data, drawn representations, recorded ephemeral experiences, taxonomies of collections of found information and objects and in the construction of poetry and narratives. There is then a requirement to value what is worthy, and edit what has resulted from these surveys, utilising the selected observations and findings as devices to develop meaningful work, which is connected to the spaces and places that the students have observed.

Site Analysis

‘...unlike music, sculpture, film and literature, a construction (non-mobile) is intertwined with the experience of a place. The site (of a building) is more than a mere ingredient in its conception. It is its physical and metaphysical foundation’⁵ Steven Holl

Site analysis is often seen as a recording of fixed phenomenon of the place under observation, but there are many layers of such phenomenon. The acknowledgment of both the tangible and intangible data is crucial in the acquisition of a complete picture.

To enable students to register a complete and holistic understanding of the site or place it is necessary for them to explore and record both the ‘facts’ and the ‘feelings’, of the site that is under investigation. This requires the students to approach this exploration with an open mind and body to allow absorption of the invisible qualities, alongside the visible aspect of that site.

Raoul Bunschoten of CHORA Architects describes this as ‘two skins’⁶. The first being the natural world, the earth, ground, sea on which we live. He refers to this as the first skin. The second skin is the way we live on the world, the skin of houses, cars, cities, people and information. He goes on to say ‘Our second skin and first skin are both dynamic and they interact with each other and I think on any site that you go to, you always have to understand the relationship between the two skins’.

Each author has currently been working independently on developing site registration techniques that align with their own research interests. One focus has been on the scientific recording of data and relies on quantifying qualities of the site. The second process attempts to capture the intangible; the qualitative; and elicits methods to graphically represent these elusive qualities. Reflecting on both methods, and critiquing their strengths and weaknesses we are currently developing a hybrid methodology; one which conjoins both approaches in the production of a more complete analysis process allowing the many layers of site’s information both visible and invisible, factual and imagined, historical and present to be realised.

⁵ Holl, Steven. *Intertwining*. Princeton, Princeton Architectural Press, 1996.

⁶ Bunschoten, Raoul. “Site, context and place” in: Anderson, Jane (ed.). *Architectural Design*. Lausanne: AVA Publishing. 2011. p. 78-103.

The Pragmatic

Survey: ‘the act of examining and recording the measurements, features, etc. of an area of land in order to make a map or plan of it’⁷

It has long been a problem for students to engage completely with a site survey through the process of analysis. The default is that such a survey is a visual inspection only. A further observation lies within the current context of the developing digital age, where it is becoming more apparent that there is a tendency to rely on visual aids like google maps and street view to gather knowledge of a site as opposed to physically interacting with it. Students also appear to find it unclear as to how to embark on the process of analysis, uncertain of what this really means in the context of the design process.

A selected group of Stage 1 students from the Mackintosh School of Architecture were tasked with testing an alternative site survey whilst in Ardrishaig, a small village on the west coast of Scotland on the edge of Loch Gilp. The students were briefed to explore the nature of the existing context and its environs. This short 2-day project was intended to elicit creative awareness of the rural landscape and an understanding of the physical and spatial context of the village of Ardrishaig and its unique relationship to its spectacular surroundings.

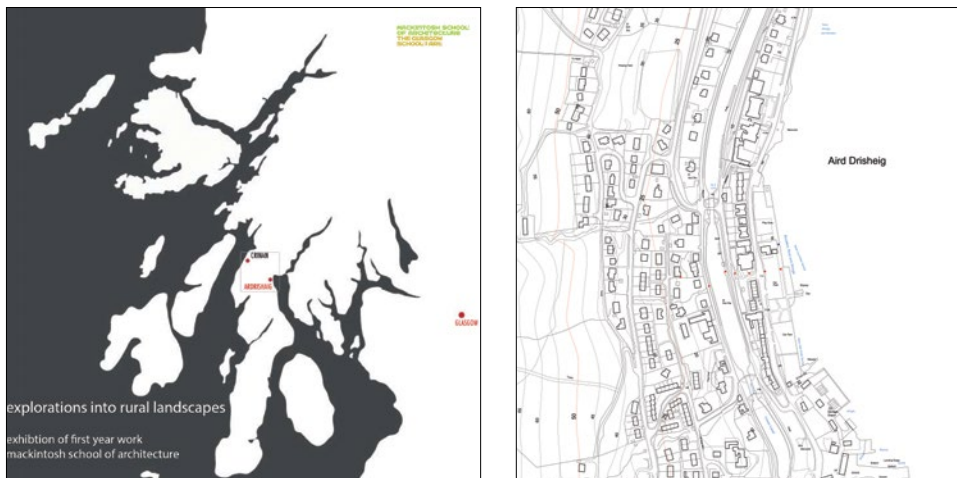

Fig. 01 & 02. Ardrishaig Poster of the Student project and locations of weather stations.

Source: author.

This alternative site survey resulted in the students being tasked with taking part in a series of scientific and environmental cataloguing over a 24-hour period. Their recordings included readings of temperature, humidity, direct solar exposure, directional noise, surface temperature and wind speed and direction. Their engagement with this scientific data gathering appeared to increase their understanding of the site in two ways. Firstly, they gained specific knowledge of the factors that they had been

⁷ *Oxford Dictionary of English*. Oxford. Oxford University Press. 2010 (third edition).

observing and recording, and secondly through the act of recording and collating data they achieved a deeper and more subtle understanding of the site and the locale.

It was found that when rooting the ‘site survey’ and data recording in science it became more quantifiable for the student and also much clearer as there was no ambiguity to the readings. There were questions that arose due to anomalies in the data recorded but this only added to the final understanding of the site as these anomalies forced the student to check and recheck the data and observe their surroundings to fully understand and explain any rogue recordings. It became clear that through the necessity to understand and articulate these exceptional readings the students were able to engage with the site at a more pragmatic level and that this in turn supported the design process.

It is felt that the act of factual data gathering not only allows the student to understand a site through the prism of an unquestionable set of numbers but it also provides time and space to immerse themselves in a place and through the undertaking of specific tasks gives them a sustained insight into the site and its factual qualities.



Fig. 03. Student feel the site, *Source: author.*

The Poetic

The ‘facts’ of the site can be time consuming to gather, but are deemed to be less emotionally onerous to collect than the poetics. The registration of which also requires the investigator to have the confidence to value their personal responses. The additional challenge of registering the invisible is how to visually record the findings of experiences so that data can be re-visited during the editing process of the analysis, and if relevant, shared and discussed as part of the design development. Zumthor in his book ‘Atmospheres’ describes what he calls the ‘Magic of the Real’⁸ and recounts notes from his sketch book that he made whilst sitting in the sunshine in a square on Maudy Thursday in 2003. He articulates not only what he sees but what he hears,

⁸ Zumthor, Peter: *Atmospheres*. Basel, Boston, Berlin: Burkhauser. 2006.

the sun and the shade, the movement of the air, and how people inhabit the place. He is essentially carrying out an analysis of that place, not through measured data but through observation made as a human resting within that place.

To support students in the development of a multi-dimensional methodology in their consideration of the atmosphere within site, place and its architecture; and subsequently within their own proposals; two opportunities have been introduced into the Diploma Programme at Glasgow School of Art. Both allow time to explore and experiment with methods to elicit the confidence in those involved in recognising what they feel and how this may have relevance and value. The first of these is a 10-week PG taught elective titled Sense—Space, and the second is a one day Diploma workshop of the same name. Students begin the process with the challenge of recording the invisible. Following this a number of sense specific tasks are given. All are designed to encourage the students to connect with their intuition when exploring the world. Poetry and narratives are written, videos produced, smell maps created and soundscapes recorded, all capturing the ephemeral qualities of place and how humans reside and use the spaces under observation. Whilst not initially site specific the results show a deeper registration of their bodies in the world as they read and record the diversities of place through the capturing of sounds, smells, touch, temperature, light and shade.

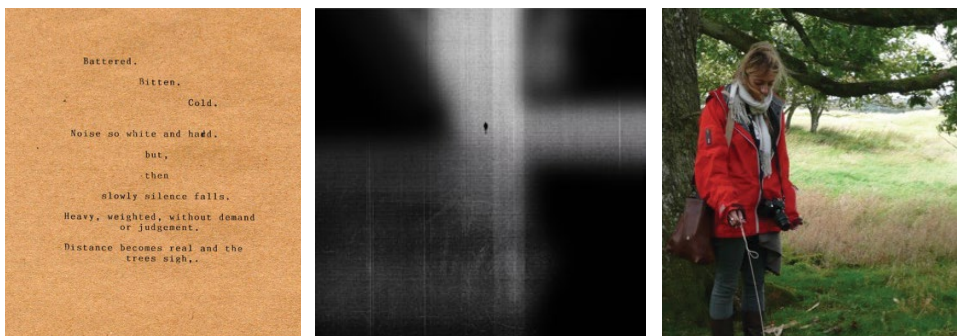

Fig. 04, 05 & 06. Two poetic observations of Place, and drawing the wind.

Source: author.

An Experiment

Facts and Feelings: an experiment

The experiment that has been designed will try to elicit the pros and cons of both types of site survey; firstly, the facts and secondly the feelings; and allow comparisons between each method, and the results gathered, to be made. The intension is to draw on the findings of this experiment to develop a meaningful multi-layered site analysis process which can be implemented within the design studios in the forthcoming academic session. The hope being that design work will be enriched by the gathering of relevant and diverse data which can be utilised to support the design process,

something which currently has been observed as lacking in relevant and useful content. Two groups will be challenged to independently explore the phenomena of the environment of a chosen site. One group will use instruments to record the facts on the site; the other will use their bodies to absorb sensual registering's of the place...the feelings. This documenting of the site will inform their response to that place ahead of a hypothetical design proposal. The experiment will not require the development of proposals as it is an exploration into the development of a site analysis methodology that is the purpose of the experiment. To try and ensure that the evidence/data is comparable each group will be directed to carry out their separate registrations at the same time, however, each group will work independently. The aim being that the resulting presentations of site data gathered will allow comparisons to be made, a sharing of methods used and discussion of the merit of each survey method to be observed and debated. It is anticipated that from the conclusions drawn the students involved will consider a more holistic approach to site survey in the future. For the authors, it is anticipated that a new site survey methodology will be established which will be rolled out in the undergraduate years in the next academic session.

Facts

*"The goal is to turn data into information, and information into insight."*⁹
– Carley Fiorina, former CEO, Hewlett-Packard Co.

The FACT survey team will be challenged to use a mobile recording instrument station (provided by MEARU, Mackintosh Environmental Architecture Research Unit) to register measurable data from the site – sound, light, temperature, wind direction and speed and other physical phenomena, that can be recorded accurately with the equipment provide. Once collected the team will be asked to prepare a presentation that demonstrates their findings and reading of the site with a view to it being develop as per the hypothetical design brief.

Feelings

'Look around you...Feel the wind, smell the air. Listen to the birds and watch the sky. Tell me what's happening in the wide world.'¹⁰ – Nancy Farmer, *The Sea of Trolls*.

Unlike the Fact group, the readings of the site will be done through the registration of phenomena by the teams' own bodies. The participants will be asked to use their individual sense receptors – eyes, ears, nose, mouth and skin to absorb information about how they feel in the space they are in. They will be asked to make notes, write words, record sounds and make drawings of what they register of both the tangible and intangible. Once collected, they will also be asked to prepare a presentation that demonstrates their findings and reading of the site.

⁹ <http://www.statistics.com/> (accessed 16.04.2017).

¹⁰ Farmer, Nancy; *Sea of Trolls*. United States: Athenaeum Books. 2004.

Conclusion

The core of this paper deals with the acquisition of skills to equip students to fully and meaningfully engage with the ‘site survey’ issues, based on the belief that this relationship is crucial in the study of architecture, and the production of proposals which are sensitive and grounded to their context.

Currently the experiment laid out in the paper is waiting to be trialled by a group of students so drawing a conclusion at this early stage is not yet possible.

The use and successes of each of the independent methodology described through the separate survey techniques have been made and the results have been shared, thus allowing the development of a hybrid methodology to be constructed. This new survey method will endeavour to ensure that the students involved have a meaningful and appropriate dialogue with the sites which they will be challenged to design proposals for, one that is fun and engaging and leads to personal and factual data that is in the unquestionable ownership of each student participant.

The development of this holistic survey proposal is currently in a testing stage, but once launched we will be in a position to reflect and refine as we develop the methodology; and through iteration will develop a process for the students to adopt that will connect them to the sites and places they are exploring and facilitate registering beyond the visual; equipping those involved with a plethora of tools to garner a deeper understanding and relevant knowledge of the sites under scrutiny. The desired outcome being that this will in time result in proposals which will be deeply rooted to their context and have appropriate narratives to connect them to that place.

Bibliography

- Dean, Hawkes. *The Environmental Imagination*. London: Routledge. 2008.
- Holl, Steven. *Intertwining*. Princeton, Princeton Architectural Press, 1996.
- Pallasma, Juhani. *The Thinking Hand*. Chichester: Wiley. 2009.
- Ewing, Suzanne; McGowan, Jeremie; Speed, Chris; Bernie, Victoria Clare. *Architecture and Field/Work*. London: Routledge. 2011.
- Farmer, Nancy; *Sea of Trolls*. United States: Athenaeum Books. 2004.
- Oxford Dictionary of English*. Oxford. Oxford University Press. 2010 (third edition).
- Butterworth, Carolyn. “Of All We Survey” in: Littlefield, David; Lewis, Saskia. *Architectural Voices*. Chichester: Wiley. 2007. p. 148-151.
- Brunschoten, Raoul. “Site, context and place” in: Anderson, Jane (ed.). *Architectural Design*. Lausanne: AVA Publishing. 2011. p. 78-103.
- <https://www.goodreads.com/quotes/959635-observation-is-a-dying-art> (accessed 14.04.2017).
- <http://www.statistics.com/> (accessed 16.04.2017).

Detour as Destination: An Architecture of Wandering

Introduction



Fig.01a. *Soria Moria* by Theodor Kittelsen c. 1900,
Fig.01b. *Wanderer Above the Sea of Fog* by Caspar David Friedrich c.1818
Source 01a: www.samling.nasjonalmuseet.no/no/object/NG.M.00546,
Source 01b: www.hamburger-kunsthalle.de/en/nineteenth-century

The painting *Soria Moria*, ca. 1900, by Norwegian artist Theodor Kittelsen, (Fig.01a) depicts a scene from a Norwegian folk tale about “Ash Lad,” a wandering suitor, trying to find his way to the golden Soria Moria Castle (in the distance) to rescue the princess before she must wed her betrothed. With his back to the viewer, one cannot help but associate this painting with works of the earlier 19th century Romantic Movement, including the notable *Wanderer above the Sea of Fog*, by German artist Caspar David Friedrich in 1818 (Fig.01b). In both instances, the men - one young, one older - hold walking sticks and gaze across the distant landscape. By concealing the faces of their subjects, the artists invite the viewer to participate in what the protagonists’ experience: a moment of “pause” in the land. Although the suitor in the Norwegian fable ultimately succeeds in winning the hand of the princess, the essence of Kittelsen and Friedrich’s paintings is not about the conclusion of a journey. Rather, their respective work suggests a powerful suspension of time – a mere moment - where the individual is one with nature and a broader wilderness. One

feels both apprehension and awe in the vastness of the natural world: man's sense of individuality and communion with a greater whole is revealed in these paintings.

Our intimate connection with the physical environment has dramatically changed since the Romantic period where walking may have been a primary mode of transportation. In the wake of the current technical revolution, automotive and technological dependencies have altered the speed of movement and information resulting in a displacement of our bodies in time and space. Convenience, ease, and efficiency govern our decisions as to whether we walk or drive, and often replace the need to wander and explore for pleasure. Author and activist Rebecca Solnit writes in *Wanderlust: A History of Walking*, that, "on foot everything stays connected...one lives in the whole world rather than in interiors built up against it."¹

Against this backdrop, many caution that the enticement and addictive qualities of the ubiquitous "screen" disconnects us from the physical world. Personal relationships to place carry less meaning: the physical act of walking and thinking has been limited through the two-dimensional experience generated by our hand-held devices, with us at all times. The increasing reality that the "lure of the screen" is keeping children, in particular, indoors, has become an urgent subject of discussion. Many educators see a worrisome disconnect – or alienation – between children and the natural world. In his 2005 book *Last Child in the Woods*, author Richard Louv singled out this problem as a significant concern today and went so far as to coin the phrase 'Nature Deficit Disorder.' He argues that there are qualities of imaginative play, reflection, and even humility that only nature can stimulate and presses for more active learning and interest in the natural world.

Complexities of wandering in the 21st century

Louv and Solnit's arguments remind us of the need for balance between pragmatic, societal needs and the romantic, singular needs of an individual in nature. The authors of this paper pose the question: If human nature requires both social contact and romantic individualism, how can architects – both as practitioners and educators – advance this necessary equilibrium? Juhani Pallasmaa asserts that, "architecture slows down, halts, reverses, or speeds up experiential time, and we can appropriately talk of slow and fast architectures...It gives limitless and meaningless space its human measures and meanings, but it also scales endless time down to the limits of human experience."² If a work of architecture can provide a deeper sense of self in time and place, then we might consider ways in which a minimal intervention can provide comprehensible scale within vastness and humble stillness within motion.

With this objective in mind, this paper examines the Norwegian National Tourist Routes as valuable precedents which allow visitors to reconcile the complexity and pace of our current technological environment while providing opportunities to realign ourselves in nature. Sponsored by the Norwegian government, these tourist stops are designed to appeal to the automotive traveler and to bring tourism to rural communities while preserving formerly inaccessible wilderness. In this case, 'inaccessible' is not

¹ Solnit, 9.

² Pallasmaa, 53

just driven by forbidding terrain; it also includes the government's focus on access for all. On a romantic level, the designs often reveal places of silence away from the road. However, moments once discovered through walking are now available by car at high speeds via structured pull-offs, and are identified with a piece of architecture or sculpture to frame views. The implications are many: How does the cadence of each experience inform the experience itself, from 90 kmh to a halt, vs. wandering and finding perhaps the same moment in space? How can the specifics, including sight, sound, smell - and, to a degree, contact with the earth - generate memory and association?

In an effort to convey the greater meaning of the tourist route as related to the tradition of Norwegian architecture, Karl Otto Ellefsen, Professor of Architecture and Urbanism at the Oslo School of Architecture and Design, recalls theorist Christian Norberg-Schulz, who “developed his theory of place or ‘locus’, saying that architectural space should not be understood as something produced, rather architecture ought to be comprehended as a process of unveiling what is already there – the task of the architect being to search for the essentials in a specific place and develop its hidden qualities.”³ These hidden qualities inextricably connect structure to place, and, by extension, place to meaning. This raises the question of how architecture can foster personal experience, at a particular time and place, in nature. Can the “noise” of our daily lives be temporarily silenced through a choreographed architectural experience in the land, as is evidenced by the Norwegian Tourist stops? It is not unlike Martin Heidegger's lecture, “Building Dwelling Thinking,” regarding the bridge as a place making entity:

“The bridge swings over the stream ‘with ease and power’... The banks emerge as banks only as the bridge crosses the stream. The bridge expressly causes them to lie across from each other... With the banks, the bridge brings stream and bank and land into each other's neighborhood. The bridge gathers the earth as landscape around the stream.”⁴

In Heidegger's estimation, no place is understood until it is somehow marked, registered. The construction of a bridge, for instance, creates a place in the world that then gathers space. Similarly, the architectural markers of Norway's National Tourist Route, by their existence, gather the ground and views around them. They provide a portal through which to comprehend nature and to invite further exploration into the wilderness.

³ Berre, ed., 22.

⁴ Heidegger, 354.

Case Studies: Norwegian Tourist Stops

The 18 Tourist Routes provide a collage of amenities such as rest stops, viewing platforms, visitor centers, picnic benches and bird watching shelters. Despite this variety, the common experience in all locations is that nature is being made accessible by the car, whether on roads shared with those who use them every day or those that are more remote. Most, if not all, are tightly responsive to the specific place in nature as they ‘gather’ the unique qualities of place to them, scaled to the human. This overall approach to the natural world, given the varied landscapes of Norway, creates unique architectural responses for each location.

The following four attractions, that roughly span the length of the country from North to South, were selected for study because together they create a distinct story for both individual and larger groups to have brief, but intense encounters with the land: The attraction on Senja Island near the village of Bergsbotn, the Dalsnibba Skywalk in Møre og Romsdal county, the Hellåga rest area along Helegelandskysten, and the Sohlbergplassen viewing point along the Rondane mountains. They are organized into two thematic categories: viewing -from a distance and within vastness, and embedding - direct, intimate connection to the place.

Viewing the Terrain

Despite recognizable differences in scale, the smaller viewing platform at Bergsbotn and the more extensive Dalsnibba Skywalk are similar in that they invite visitors to pull off the road and take in the unique views to the fjords and mountains that would be difficult to access without the built form.



Fig.02a and Fig.02b Cantilevered viewing bridge at Bergsbotn, Senja by Code: Arkitektur.

Source: www.architecturenorway.no/projects/travelling/bergsbotn-2010

Located along the coast, the linear viewing platform at Bergsbotn is visible along the sharp curve of the adjacent road (Fig.02a). Once out of the car, there is a small threshold between the road and platform that denotes the moment of passing to a new territory. From this subtle edge, the cantilevered long platform is detached from the road and extends in opposite directions with the support of steel columns below. The wooden walking surface divides into three strips, with the middle strip rising upward over the fjord, mimicking the heaving forms of the mountains beyond, and creating an uninterrupted 360 degree panoramic view of the rugged Norwegian

landscape (Fig.02b). At the other end of the cantilevered platform, the middle portion descends downward, exposing the precarious relationship to the ground. By floating both the structure and the visitor above the land, Code Arkitektur creates a quality of tension where the built form places the individual into a remarkable natural scene. The diminutive scale of a person is in sharp contrast to the vastness of this grand site, at once awe inspiring and humbling.

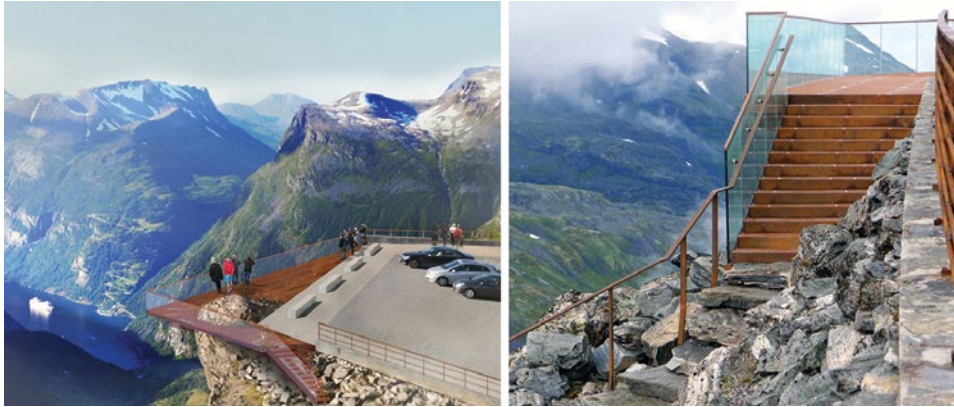

Fig.03a: View from above of Dalsnibba Geiranger Fig.03b: Detail at stair

Source 03a: www.ostengen-bergo.no/prosjekt/dalsnibba-1500-moh

Source 03b: www.landezine.com/index.php/2017/01/dalsnibba-skywalk

The Dalsnibba Skywalk, named for the Dalsnibba mountain near the village of Geiranger, shares a similar goal of place making for the purpose of enjoying exceptional views, albeit in an arguably more spectacular location than Bergsbotn (Fig.03a). In contrast to the more intimately scaled Senja attraction, this tourist stop was designed to accommodate a large number of visitors to a uniquely Norwegian site hundreds of meters above sea level. With roads accessible for only a limited seasonal period, the Dalsnibba stop includes three levels of parking, two of which are pull-offs adjacent to the road along the ascent to the top of the mountain, and the third at the highest accessible point marking the final destination. The skywalk culminates at a corten steel grate viewing platform that cantilevers dramatically off the concrete vehicular arrival. The angular geometries of the platform are edged by a minimal glass guardrail, further simplified to a single metal bar handrail at the point where the steel metal stairs meet the jagged stone stairs connecting the three levels of parking along the steep terrain (Fig.03b). The tactile qualities of the natural and man-made materials, along with the unobtrusive architectural details, intensify the moment of viewing and reveal a landscape with such commanding presence that the individual is insignificant within it.

Embedded Encounters

“... walking is a subversive detour.” – Rebecca Solnit



Fig.04a: Hellåga rest area, Landskapsfabrikken. Fig.04b: Stair to the water
 Source: www.nasjonaleturistveger.no

In contrast to the stops in Bergsbotn or Dalsnibba, the attraction at Hellåga along the Helgenlandskysten Route and Sohlbergplassen in the Rondane area, are less about the choreographed placement of the individual in a distant scene and more about wandering through and being immersed in the place itself.

Upon arrival at Hellåga, there is a curvilinear bathroom facility close to a tree edge on one side and a picnic area on the other (Fig.04a). A rusted steel platform modestly grips the ground as if a barnacle securing the land to the water below. In contrast to the gray tones of both the road and surrounding stones, this raised surface with subtle, single line metal handrails, is the start of a red metal stair that descends through a zone of low growing vegetation toward the water’s edge (Fig.04b). At roughly the seam where wild shrubs can no longer grow on the rock, this stair transitions into buff-colored concrete steps, without rails, which cling tightly to the similarly toned rock face. The concrete stepped path dips directly into the water without a formal landing, suggesting a poetic continuity with the land on the other side of the fjord. The Hellåga rest stop is a place where visitors can fish from the edge of the stair, or wander beyond to a place of their own choosing.



Fig.05a: Plan. Fig.05b: Sohlbergplassen view, Fig.05c: Underneath the structure
 Source: www.holmebakk.no/sohlbergplassen/photos.html

Along the Rondane Mountain route, the Sohlbergplassen attraction is introduced by two separate concrete paths fastened along the length of a vehicular pull-off (Fig.05a). Held at the same elevation, the paths weave through an area of dense pine trees and eventually merge to form a platform with a direct view to the lake and mountains beyond (Fig.05b). This framed view is said to be the location where Norwegian Neo-romantic artist Harald Sohlberg painted his well-known work, “Winter Night in the Mountains.” The relationship between the level, curvilinear platform, the gently sloping hill, and the surrounding trees frames the view beyond. Structurally, the platform is supported by thin steel columns that angle slightly so the foundations avoid disturbing the buried tree roots. One can reach the forest floor by a stair at the outer edge of the platform so that one can experience the moment from the stop or wander through the forest to the lake.

Rectangular openings are positioned throughout the platform, bringing sunlight and rain to the ground below (Fig.05c). Additionally, the thick concrete railing not only acts as a fluid, guiding ribbon, but also it is the stiffening beam at the edge of the structural slab. Although Sohlbergplassen is like an amoeba with no defined shape flowing around the vertical pine trees, the concrete material itself creates a sympathetic relationship between the two. Architect Carl-Viggo Hølmekjær notes that the “project proves fully that concrete does not necessarily have to be a technical, hard, cold and dead material. The concrete here is in fact experienced as a warm, beautiful, soft material that is very much alive.”⁵ The distinctive concrete form does not overpower or control the natural surroundings. Rather, by being embedded in the wild, it offers the possibility for a visitor to wander beyond through less prescribed means.

Intended Conclusions

The architectural detours on the Norwegian National Tourist Routes are undeniably using today’s technology, materials, and fabrication in innovative ways that allow for a complex dialogue to occur with nature. Architecture, when characterized by a thoughtful response to the clues of the land can bring us back to nature. Although wandering – in direct contact with the ground – is an intimate form of embodiment, the architectural detour, when sensitively handled, can become the destination that even briefly, slows down time. The routes provide a point from which to comprehend nature and to invite further exploration. In this way, architecture can generate a contemplative and subversive detour that simultaneously gathers a quality of wildness around it. In contrast to an architecture of containment, there is the possibility for the eye and mind to wander, as “a guard on patrol to protect the ineffable.”⁶

With the economic intent of promoting the interests of the tourist industry, it is interesting to speculate on how Norwegians themselves may see these interventions. Culturally, the country prides itself on the close relationship between its citizens and the land they inhabit and treasure. Known for its Viking and explorer’s history, wandering through unmarked terrain in Norway *is* the destination and a fundamental piece of Norwegians’ cultural landscape. Would they therefore critique these stops as

⁵ Krokstrand, 123.

⁶ Solnit, 11.

an imposition, an interference, by 21st Century society, corrupting their country's great asset? Given the Nordic legacy of exploration and reverence for its wilderness, one might think that these would be considered mere "follies"; useless for the true native and a prescribed, perhaps extravagant, course of discovery that ultimately limits one's own ability to explore beyond. One can certainly argue about the specific successes or failures of the numerous rest stops, but there is an overriding accomplishment that is worthy of study by both educators and practitioners: They all provide a moment, a pause, from the speed of the car to one's own individual pace, connecting our technologically 'driven' selves to the scale of our beings in the places around us. At the stops, one embodies the terrain in front of and around oneself. The built form is not at odds with the landscape; rather it intertwines and elevates the experience itself. Once drawn into these moments, there is an invitation to view, wander, and reflect, not unlike the 19th century images that artists like Kittelsen and Friedrich aspired to reveal.

Bibliography

Books:

Berre, Nina, ed. *Omveg / Detour. Arkitektur Og Design Langs 18 Nasjonale Turistvegar / Architecture and Design along 18 National Tourist Routes*. Oslo: Norsk Form. 2009.

Heidegger, Martin, ed. David Farrell Krell. *Basic Writings*, "Building Dwelling Thinking," lecture, August 5, 1951. Harper Perennial Modern Thought, 2008.

Louv, Richard. *Last Child in the Woods*. North Carolina: Algonquin Books of Chapel Hill. 2005.

Pallasmaa, Juhani, *Mind in Architecture*. MIT Press: 2015. p. 52-53.

Schluchtmann, *Architektur and Landshaft in Norwegen (Architecture and Landscape in Norway)*. Germany: Hatje Cantz. 2014.

Solnit, Rebecca. Introduction. *Wanderlust: A History of Walking*. London: Penguin Books. 2000. p 3-13.

Paper in journal:

Ellefsen, Karl Otto. "Detoured Installations: The policies and architecture of the Norwegian National Tourist Routes Project." *Architectural Design*. v.85, n.2. 2015 Mar/Apr. p. 64-75.

Krokstrand, Ole H, Ranstand, Reiulf, Hoelmekbakk, Carl-Viggo. "Splendid concrete architecture in National Tourist Routes in Norway." *Structural Concrete*. Vol. 15 Issue 2. June 2014. p.117-125.

Larsen, Janike Kampevd. "Global Tourism Practices as Living Heritage: Viewing the Norwegian Tourist route Project." *Future Anterior: Journal of Historic Preservations, History, Theory, and Criticism*. Vol. 0, Issue 1. University of Minnesota. Summer 2012. p. 67-87.

Augmented Maquette for Urban Design

Introduction

Augmented Reality (AR) is used in different disciplines with several purposes. In the field of architecture and urban planning it can be very effective if applied to anticipate design projects and their effects. This can be done on-site, through the augmentation of the transformation area, or off-site, using physical models of the same context. This contribution focuses on Augmented Reality¹ with physical scale models, later named *Augmented Maquette*.

AR enable to join the specific characteristics of the real and the digital environment, and in so doing the user can take advantage of the peculiar and unique nature of both. This is the reason why we believe that the application of such a tool can be very effective in supporting an informed dialog between the different actors involved in the process of urban transformation, including stakeholders, decision makers and citizens. Likewise, it can be very effective for higher education in architecture and urban studies.

The paper presents pros and cons of physical and digital models and advantages and disadvantages of a mixed solution. It briefly describes a qualitative comparative study among three selected apps for AR, based on the evaluation of their efficacy in outdoor environments and with scaled models. It then outlines the typology of “layers” that can be added to physical models for generating experiential dynamic *maquettes*.

Physical and Virtual models

The way we represent our design projects has of course an influence on design thinking, and hence on the design process and the final outcomes², as it is clearly shown by several architectural projects around the world. The use of physical mockups as a tool for supporting design thinking, evaluation and communication of design proposals is not new to the architectural domain. The use of digital models, instead,

¹ Some references to the research on the topic of AR for Urban Design done at *Laboratorio di Simulazione Urbana 'Fausto Curti' of Polytechnic of Milan* are: Piga, 2010; Cibien et al., 2011; Piga et al., 2015; Piga & Morello, 2015; Calabrese & Baresi, 2017; Cibien, 2017.

² Sarkar & Chakrabarti, 2008

is relatively novel even if it is already widely adopted around the world³. In parallel to the technological advancements, the recent innovative modeling procedures are widening the possibilities of making mockups in both approaches; in fact, along with the traditional ways of modeling, the introduction of Computer Numerical Control (CNC) machines in the field of architecture led to new ways for manufacturing physical mockups based on additive, subtracting or cutting processes⁴; similarly, in the digital representation domain the introduction of procedural modeling opened up new possibilities.

The used of mixed solutions that combines physical and digital elements, that is Mixed Reality (MR) (Fig. 01)⁵, that includes Augmented Reality as a subclass, is even newer, although in expansion. Anyhow, the era of a largely adopted Mixed Reality approach in the today professional practice or in higher architectural education is still at the very beginning. Since this process has just started and it is not largely diffused yet, the understanding of the implications on design thinking in the professional practice at a large scale can be only assumed.

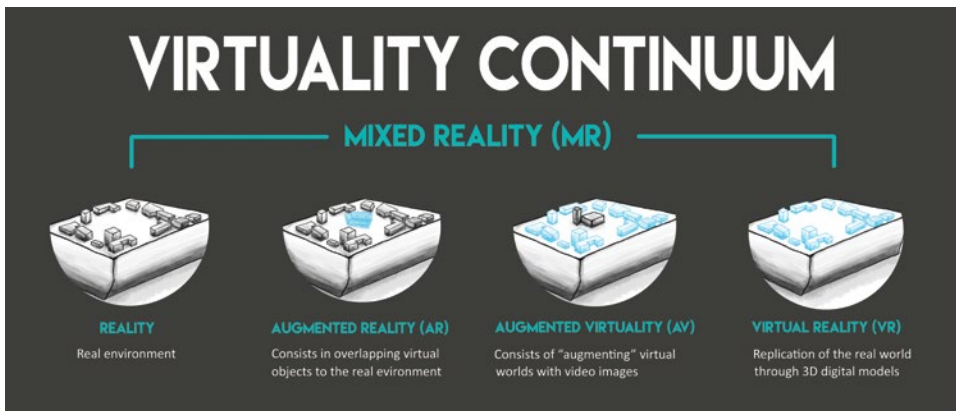

Fig. 01. Representation of the concept of *Virtuality Continuum* by P.Milgram, T. Haruo, U.Akira, F.Kishino, 1994⁵. Source: Valentina Petri

Moreover, even when applied, these types of solutions are generally confined at the end of the process, namely to the phase of communication to clients and other stakeholders. Despite this, it is easy to suppose that the opportunities provided by this mixed approach will be soon wider, impacting the design process from conception to final construction.

The combination of physical and digital models will enable to take advantages of the specific characteristics of both media, enabling at the same time to partially overcome the limits of both; for instance, it would be easier to simulate different weather condition on a physical model. Anyhow, as shown below, an analysis on Augmented Reality apps on the market shows that there is still a lack of products

³ Mitchell & McCullough, 1995

⁴ Capati, 2017

⁵ Azuma, 1997; Milgram et al., 1994; Van Krevelen & Poelman, 2010; Barba & MacIntyre, 2011; Calabrese & Baresi, 2017

dedicated to the augmentation of physical models, even if there are researches working on the subject⁶.

Physical models have been always widely used for assisting the design development and as a – easy to interpret – communication media for presenting the project to clients and other stakeholders. The main relevant property of scaled models is that they are physical. Their tangibility reduces the gap between representation and reality and this generally ensures the easiness of understanding of contents, especially for lay people. Moreover, with its solid three-dimensionality, mockups are generally perceived as trustable. This perception is reinforced by the fact that their scale cannot be modified, unless to build another mockup; in other words, it is not possible to zoom in and out physical models and it is possible to visually measure and compare the represented urban elements among them, without panning the model on the screen.

The scale has of course a direct impact on the level of details that it is possible to achieve. Coupled with the portion of space it represents, this defines the dimension of the final model, that is often difficult to transport or to send. Of course the variable of the scale and the area to represent are inversely related, hence, in order to produce a territorial representation of an area we have to increase the scale, unless we have a wide place where to locate the model. But over a certain degree of its dimension the problem of usability would occur, since the inner part of the model would be less accessible – either visually or for manipulation – than the peripheral area.

Another important element of physical mockups is that they generally depict a moment in time, even if it is possible to use analog tools to simulate different circumstances on a model, e.g. wind or lighting conditions⁷. If materials are used consciously their materiality can of course effectively replace the characteristics of the physical world, and so these can be effective in giving back reliable physical reactions in different ways, from the building structure and the process of construction⁸ to sound reverberation and so on.

On the contrary, the main important feature of **digital models** is that they are not physical. This is an obvious consideration that implies a lot of consequences and that makes physical and digital models hardly interchangeable. Renders are increasingly adopted for the communication of design projects to lay public, but the trustfulness of their representation can be perceived lower than physical models; in fact, it is harder to visually weight the tridimensionality of the area, as we do with scaled models, and to individuate inaccuracies.

Differently from physical mockups, digital ones do not allow a direct interaction, that is in fact mediated by an interface. Of course interfaces that allow an immersive and naturalistic interaction⁹ are easier to use, especially for lay people. In fact, the use of ‘go between’ devices, such as mouse and keyboard, can result annoying for people that are not used to deal with these kind of tools in everyday life. Anyhow, tablets

⁶ Cibien, 2017

⁷ Podestà, 2017

⁸ Rossetto, 2017

⁹ Loomis et al., 1999

and smartphones are becoming more and more integrated in people's activities at any age, and this is gradually thinning the digital divide, that in any case is destined to disappear.

While scaled models cannot be resized, digital models can be zoom in and out allowing the observer to rapidly pass from one scale to another. Even if in doing this it is of course easy to lose the sense of scale of the area, this allow a flexibility in linking details and larger views that is impossible with physical mockups. Hence, the level of details that is possible to embedded in a digital model has potentially no limits, and the same for the portion of territory to represent. The limits are in case given by the weight of the final product, the performance of the machine and of course the time and ability needed to perform the process. This intangibility of digital models allows an easy exchange and transportation.

Moreover, the intangibility of digital models allows to easily act on time, for instance by passing from a period of a year to another one, or by compressing long periods of time in a short one. From the multisensory perspective digital simulations allow to calculate different types of data related to the future environment, but from an experiential perspective nowadays these can easily and accurately reproduce the visual sphere only; for instance, even if it is easy to embed the urban soundscape into the model, it is hard to realistically anticipate the final results of non-existing condition (i.e. the design project), especially for open areas, since the soundscape originates from the cumulative interaction of different elements. In fact, the procedure for simulating this issue is still not widely adopted, since the computation requires a relevant amount of information, a specific model that include for instance urban materials, software able to run the simulation and machines capable of running the analysis. Other senses are even harder to being correctly simulated, even if researches in robotics and human computer interaction are expanding the possibilities of using such data, thanks for instance to haptic interfaces and similar.

As shown before, virtual and digital models have different and peculiar properties. The combination of the two modalities allow to melt together the potentialities of both in a mixed solution¹⁰. **Mixed Reality** can serve two main applications in architecture: (i) *on-site augmentation* (ii) *in-vitro augmentation*. For instance, it is possible to simulate and test design project in 1:1 scale on-site, hence with a subjective view, or it is likewise possible to augment physical models with digital layers. Two main typology of digital informative layers (data) can be add in both cases: (i) *experiential* (ii) *dataset*. In the first case, it is possible to outfit the model with data that contributes to render the situation as it would be perceived in reality, e.g. shadows, people, textures and so on; in the second case the augmentation can show information related to the urban context, such as temperature or other weather variable, information regarding the number of people living the area, and similar. While in the first case we are in the range of *experiential simulation*, in the second one we enter the domain of *conceptual simulation*¹¹.

¹⁰ Ben-Joseph et al., 2001

¹¹ McKechnie, 1977

The combination of real and virtual elements can of course work with *indoor* and *outdoor* Augmented Reality, but also for *Augmented Maquette*. In this case, the information can be shown dynamically by a projection on the surfaces of models, as for the *Luminous Planning Table* - designed at Massachusetts Institute of Technology in the late nineties¹⁰ - and similar tools¹², or through devices, such as tablet or Head Mounted Displays [Fig. 2]. While in the first case the direct interaction with the model is preserved, in the second one the interaction is mediated. In fact, with tablets or similar tools the interaction is intermediated by the device that remains always perceivable, i.e. the augmented view is confined within the screen of a non-immersive device and the direct interaction with the model is lost; in the second case, the interaction with the model is direct and naturalistic¹³ and the device is no longer perceived. Of course, the first set of solution guarantee an easiness of use and an interaction that is more fluid than the second one. In both cases, beyond the quality of the model, the experience depends also on the hardware (immersive or non-immersive), and on the software used.

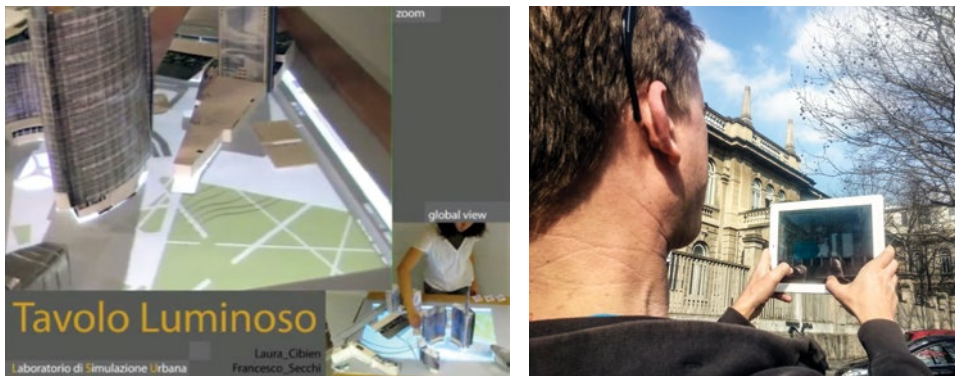

Fig. 02. (a) Tavolo Lumiso (labsimurb – POLIMI 2010). By rotating a physical button it is possible to modify the shadow casting on the interactive table surface

(b) Onsite AR testing for the “Ri-pensiamo via Celoria” project by labsimurb for the Città Studi Campus Sostenibile inter-university project (2014)

As recalled before, to the authors’ knowledge, **Augmented Reality** solutions today on the market are not designed specifically for augmenting physical models, named here **Augmented Maquette**. It is then necessary to use applications designed for indoor or outdoor AR and – improperly – apply them to physical models. This imply a set of problematics related to the correct geo-location of the virtual elements within the scaled mockup, to the fluidity and stability of the visualization, and so on. In order to understand which is (today) the most suitable app for augmenting physical models, an investigation of (Android) apps was done by the authors. From a wider list of AR app for architecture, we selected the three that seemed to be the most suitable for our purposes, namely: SightSpace by Limitless Computing Inc., Augment, and

¹² Cibien et al., 2011; Cibien, 2017

¹³ Loomis et al 1999

Urbasee by Artefacto. A qualitative analysis of the apps has been performed comparing their performances in outdoor environment with the ones with a physical scaled model of the same area; the analysis was developed investigating the following technical issues: (i) Stability, (ii) Responsiveness, (iii) Texturing, (iv) HMD – Head Mounted Display (v) Markerless option. More in detail:

- *Stability*: level of steadiness and alignment of the 3D model to its location in the real world. In particular, the digital model should remain stable and with a low rate of flickering at its location and correctly collimate to the real context even when the user is moving around. This is related to the Tracking System Delay that is the “time [needed] to measure the position and orientation of the user’s head” together with the Image Generation Delay, that is the “time for the graphics engine to generate the resulting picture”¹⁴.
- *Responsiveness*: the degree of real time reaction of the virtual environment when a rotation/move/zoom command is input. This is linked to the Image Generation Delay.
- *Texturing*: the render quality of the texture of the model.
- *HMD*: when the app allows to visualize the model with a simple Head Mounted Display this issue assesses the responsiveness of the app to the navigation with such a device. This is important because in case of slow synchronization - namely latency - between the movement of the user and the relative movement of the scene, this delay often provokes nausea and discomfort. This is linked to the Display System Delay, that is “the time required to display the image in the Head Mounted Display”¹⁵.
- *Markerless*: this issue simply says if the app can work without a Fiducial Marker as a reference for correctly locating the model in the real context. Apps that do not need this reference are classified as markerless; these generally locate the model according to the geo-spatial localization of the user for on-site navigation, or thanks to beacons, or 3D scanning\tracking and recognition of the environment and its elements (i.e. computer vision: image recognition and 3D object tracking).

An assessment of the apps performances for each issues between (i) and (iv) was done and a qualitative evaluation, ranging between low, medium, high, was associated to each app. It is important to highlight that the 3D model was modified, e.g. simplified, in order to work properly with such tools. The outcomes of comparative assessment are synthetized in Fig. 3.

¹⁴ Mine, 1993

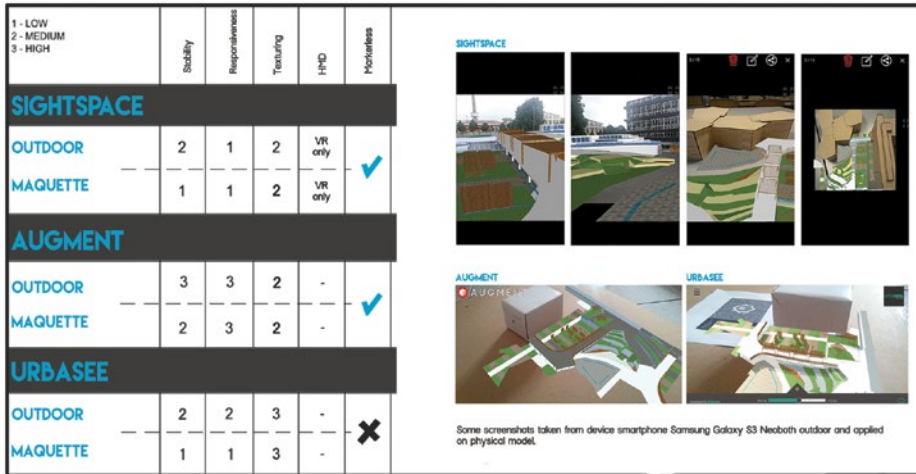

Fig. 03. The matrix shows the results of a comparative analysis between the three mobile AR applications under investigation: SightSpace, Augment, Urbasee. The right side of the image presents the qualitative results of the study: for each app a comparison between outdoor and indoor performances was conducted according to stability, responsiveness, texturing, Head Mounted Display, markerless option. If read together the matrix allows a comparison between the three applications. On the left side of the image it is possible to visualize some screenshot of the testing phase: the first to images (up-left) refer to outdoor AR, while all the other to in-vitro AM

The three apps, as expected, behave better in real environment than with scaled models. In fact, the reduction of the 3D model to the scale of the physical mockup generally generates some problems in the correct functioning of the apps, even if by modifying and simplifying the 3D model the problematics can be partially overcome. For instance, SightSpace by Limitless works well for outdoor AR, but it loses stability when it works with scaled 3D models. SightSpace is the only solution, among the studied ones, that allows to use HMDs, but with Virtual Reality mode only. This is a relevant lack for AM solutions, since it is of course crucial for a two hands interaction with the physical models. Both SightSpace and Augment provide markerless solution that allow to resize, rotate and move the model on the screen. Stability and Responsiveness in Augment remain excellent in outdoor and on *maquettes*; the stability remains quite good even when moving the device. In a recent app implementation, the quality of texturing increased a lot, even if this is still not optimal. The quality of texturing is instead excellent in Urbasee, that assures the more realistic outcome among the three. Unfortunately, today, using Urbasee for augmenting scaled models is still not efficient, due to the low stability of the digital model and the low responsiveness, in fact the app does not follows the movement of the device in a congruent and fluid way. Between the three apps Augment is the one that better fits the requirements for AM, but in general, stability and responsiveness are too low in all the app tested, while the quality of texturing can lead to medium/high results. Unfortunately, this parameter alone is not enough for a correct usage of AM for urban design purposes. In conclusion, the comparative analysis of the apps, shows that the development of the software for Augmented Maquette still need some relevant development for a proper application

in the architectural field. It is in any case important to notice that along the research process we tested the apps several times, and in any new release the improvements done for AR were useful for AM as well.

Conclusions

Mixed Reality for urban design is still far from being efficient and within reach in the urban design domain. Too many technological constrains are still limiting its applicability at the large scale and within all the different phases of design projects. In fact, for instance, it necessary to clean and simplify the model for enabling mobile tools to correctly handle them, and too often the app should be set to correct visualize and geo-locate the mockup in the real environment; moreover, this setting process should be often repeated several times for reaching the proper alignment of the model. Hence, this solution is far from being fluid enough for being integrated in the flow of the design process. The problem of low performances of smart devices in handling big 3D models can be overcome by solutions that connect the device directly to Personal Computers that do the computation, but this solution reduces the usability of the system in terms of portability and, due to costs, of the number of devices that can be used at the same time.

Despite the technical problems encountered, we started a process for testing the applications of AR in architectural higher education within the course of Architectural and Urban Simulation, proff. B. Piga and R. Salerno, at Polytechnic of Milan, and within a process of public participation related to the Campus Sostenibile inter-university project¹⁵. These first applications allow to half-see the benefits of such an approach, in fact they showed the potential usefulness of the tool, while highlighting the current technological constrains, that probably slow down the diffused use of such tools for urban design purposes.

A further technological development of tools and devices, let us envision applications that will allow students and professionals to use multisensory simulations of their design projects. Today, instead, when used for depicting future environments, these applications are mainly devoted to convey visual and kinesthetic aspects. If experiential simulations will be more integrated in the entire design process this will – hopefully – have a positive influence on design outcomes from an experiential perspective. It is in fact probable that its application will reinforce the attention on the human-environment interaction¹⁶, rather than the architectural object per se.

The continuous rapid development of these applications allows to hope that there will be an improvement that would also involve the app usability with physical models. This will lead to a new generation of model making, that will consider a combination of digital and physical elements, echoing what is already happening in smart cities. Will Augmented Maquette be a novel and useful support for designing and envisioning the city of the future?

¹⁵ Piga et al., 2014

¹⁶ Piga & Morello, 2015

Bibliography

- Azuma, R. T. (1997). A Survey of Augmented Reality. *Presence: Teleoperators and Virtual Environments*, 6(4), 355–385.
- Barba, E., & MacIntyre, B. (2011). A Scale Model of Mixed Reality. In *Proceedings of the 8th ACM Conference on Creativity and Cognition* (pp. 117–126). New York, NY, USA: ACM.
- Ben-Joseph, E., Ishii, H., Underkoffler, J., Piper, B., & Yeung, L. (2001). Urban Simulation and the Luminous Planning Table. *Journal of Planning Education and Research*, 21(2), 196–203.
- Calabrese, C., & Baresi, L. (2017). Outdoor Augmented Reality for Urban Design and Simulation. In B. E. A. Piga & R. Salerno (Eds.), *Urban Design and Representation* (pp. 181–190). Springer International Publishing.
- Capati, A. (2017). Architectural Modeling in a Fab Lab. In B. E. A. Piga & R. Salerno (Eds.), *Urban Design and Representation* (pp. 117–126). Springer International Publishing.
- Cibien, L. (2017). Luminous Planning Table: TUI as Support for Education and Public Participation. In B. E. A. Piga & R. Salerno (Eds.), *Urban Design and Representation* (pp. 191–205). Springer International Publishing.
- Cibien, L., Secchi, F., & Piga, B. E. A. (2011). The “Tavolo Luminoso” How To Built A New Tool Suitable For Supporting Representation, Communication And Participation. In J. Breen & M. Stellingwerff (Eds.), *Envisioning Architecture: 10th Conference of the European Architectural Envisioning Association* (pp. 253–258). Delft, 14 – 17 September 2011: Technische Universiteit Delft.
- Loomis, J. M., Blascovich, J. J., & Beall, A. C. (1999). Immersive virtual environment technology as a basic research tool in psychology. *Behavior Research Methods, Instruments, & Computers*, 31(4), 557–564.
- McKechnie, G. E. (1977). Simulation Techniques in Environmental Psychology. In D. Stokols (Ed.), *Perspectives on Environment and Behavior* (1°, pp. 169–189). New York, London: Plenum Press.
- Milgram, P., Takemura, H., Utsumi, A., & Kishino, F. (1994). Augmented Reality: A class of displays on the reality-virtuality continuum (Vol. 2351, pp. 282–292). *Telemanipulator and Telepresence Technologies*, SPIE.
- Mine, M. R. (1993). Characterization of end-to-end delays in head-mounted display systems. *The University of North Carolina at Chapel Hill, TR93-001*.
- Mitchell, W. J., & McCullough, M. (1995). *Digital Design Media*. John Wiley & Sons.
- Piga, B. E. A. (2010). *La simulazione visiva per l'urbanistica. Il punto di vista percettivo nella comprensione delle trasformazioni urbane* (PhD Thesis). Politecnico di Milano, Milan.
- Piga, B. E. A., Morello, E., Shokry, G., & Salerno, R. (2015). A toolkit for collaborative design: envisioning and sharing the identity of place through

- traditional and emergent techniques of simulation. In: Anetta Kępczyńska-Walczak, *EAEA-12: Envisioning Architecture: Image, Perception and Communication of Heritage*, Lodz (Poland): Lodz University of Technology.
- Piga, B. E. A., Morello, E., & Signorelli, V. (2014). The Combined Use of Urban Models to Support a Collaborative Approach to Design Towards the Sustainable University Campus: Participation, Design, Transformation. In S. M. Uddin & C. Welty (Eds.), *Design & Graphic Palimpsest: Dialogue, Discourse, Discussion* (pp. 53–58). Atlanta (Georgia –USA).
- Piga, B., & Morello, E. (2015). Environmental Design Studies on Perception and Simulation: an Urban Design Approach. *Ambiances. Environnement Sensible, Architecture et Espace Urbain*.
- Podestà, G. M. (2017). Daylight Simulation. In B. E. A. Piga & R. Salerno (Eds.), *Urban Design and Representation* (pp. 127–139). Springer International Publishing.
- Rossetto, A. (2017). The Model as Experience. Experience with Models. In B. E. A. Piga & R. Salerno (Eds.), *Urban Design and Representation* (pp. 103–115). Springer International Publishing.
- Sarkar, P., & Chakrabarti, A. (2008). The effect of representation of triggers on design outcomes. *AI EDAM*, 22(2), 101–116.
- Van Krevelen, D., & Poelman, R. (2010). A survey of augmented reality technologies, applications and limitations. *International Journal of Virtual Reality*, (9 (2)), 1–20.

Mark O'Bryan

Architecture, School of Architecture, College of Design at the University of Kentucky,
Lexington, KY, USA

Visualization Principles for the Beginning Design Studio

Introduction

“The concept of visualization, as set forth in this series, is extremely important; it is a subjective, creative approach and must not be confused with a photometric ‘tone-reproduction’ approach, systematically defined.” – Ansel Adams, *The Negative*¹

Teaching the creative process, whether it be photography or architecture, means preparing students to visualize. However, architecture design students have no construction experience, which makes it difficult for them to visualize a building solution. Inexperienced with architectural building construction, their judgment of scale, structural forces and other priorities are impaired. Studying existing examples is also a limitation because of an inability to see inside walls. Additionally, while architecture books have many types of representations they often lack details of construction. This paper and conference presentation explores the ways in which the author has attempted to bridge this gap between architectural construction and visualization. Specific references are made to architectural principles taught in the beginning design studios led by the author between 2010 and 2016.

Figure 1, for example, illustrates student house designs from 2011 to 2016. Each progressive year illustrates greater success with emphasis on details utilizing a teaching approach centered on visualization. The composite demonstrates a reduction in project size and increase in technical understanding of architectural orders of construction, which leads to greater levels of overall detail in the finished projects. Future research, however, is necessary for future development of assessment tools to aid in student learning. For instance, how can projects that are understood more completely lead to greater student efficacy and confidence? How might this type of learning as evidenced by student work samples be better measured, specifically how can student learning be measured over time?

World famous photographer Ansel Adams wrote in his seminal book, *The Negative*, that “visualization” is the subjective formation of a mental picture of the

¹ Adams, Ansel. *The Negative*. New York: Little, Brown and Company. 1959.

photograph prior to the shutter's release. The photographer is able to scan a scene and simultaneously use the imagination to visualize the final product. For the architect, visualization is much the same. It is the ability to imagine a building prior to construction. However, the ability to envisage a design before it exists requires knowledge of detailed architectural construction. A student may visualize a design, however that does not necessitate that it is connected with a detailed image of a finished building. This is because architectural construction is complex (Fig. 02) and details need to be understood as systematic. The student of architecture needs to understand details in context to the whole structure.

This author focuses on a small project involving very specific architectural elements (kit of parts and parameters) and develops thinking outward. Assumptions are made about general cost and scope with small cardboard sketches. Specific construction details of all connections are explained repeatedly and students are expected to know everything about the final design to the point of actual construction drawings. By making a small design in a fully complete set of representations, a better understanding of architectural construction is learned. This results in a better intuitive anticipation of a positive result for future design projects.

Focusing on a design process that utilizes few elements increases the likelihood for success, which in turn builds confidence. Confidence is crucial to the assessment of a familiar problem and utilizing knowledge to address it. While this method of teaching may appear obvious, it is not practiced in schools of architecture. Teaching architectural construction is the most difficult thing to do. How do we teach pre-visualization to architecture students? How do we instill success and confidence? These questions are addressed in the paper and presentation. The beginning student must be taught the standards of design and this means the basics (Fig. 03).

The Teaching Process

Students in the early stages need to try various approaches and overthink, or be overly self-critical of, beginning arrangements. At times, rearranging a set of simple but well detailed form relationships can result in an interesting design if the attention of both the professor and the student is focused. This is not typical because the average architecture professor and student lack direction detail focus. The author emphasizes the balance between the intuitive and systematic reasoning of students by integrating hand making and computational processes.

In general, the key successes to the studio are always that students know how to build their project as architecture and solve the complex space arrangements with purpose. From experience, this goal is impossibly difficult with beginners because they have neither construction experience nor knowledge of dimension standards. This is why at the earliest point in the design curriculum students are advised to think holistically. Design requires knowledge of how spaces are normally used and how work and living in space translates into standardized configurations. Additionally, it requires consideration of how the actual cost of construction places pressure on the efficient organization of space. Standards also contribute to mechanics, which then get modified by other factors such as structural repetition and planning by zones according

to simple regulating geometry. Plan generators are part of design learning. This learning is visualized by repeated study and analysis of existing standards. Students must learn to visualize scale incongruous with standards of hierarchy in plan design. One of the biggest teaching errors along with the absence of systematic detailing is the lack instruction on planning. Limiting area options by dictating a planning grid is recommended. The students' gap in knowledge and experience is narrowed by repeated and rigorous analysis and corrections (Fig. 04).

The beginning design students have been exposed to media rich environments, but have little experience in rigorous hand drawing or construction. Combining hand drawing with digital media encourages students to think and see in terms of architectural orders of construction. Drawing demonstrations use overlay trace and overlay digitally constructed print media to help visually explain the rule systems and architectural orders of construction. Students are introduced to full-scale detail drawing and are expected to draw complex construction sections and detailed assemblies by the end of the year. A Structural and Material Concepts companion course with a BIM software requirement balances speed and accuracy with rules and design concepts. Another innovation is a method of learning as teaching where students are given teaching assignments involving details of visualization.

Using a combination of representations displayed in the studio allows the student to see very high standards of quality. Hand drawing assignments with balanced attention on concept combined with speed and precision focuses the student's visual awareness on "seeing." Later on when students are working in virtual digital BIMM environments they are shown how hand drawing trace overlays on top of digital output can focus attention for design edits and detail development. The visual accuracy inherent in BIMM environment with the return to hand editing makes fluid the act of design and creates a more complete picture of the developing context for the student to see and make improvements to the design. This in turn improves seeing and thinking in this curriculum. Criteria and evidence from past studios demonstrates substantial improvement in student representations.

Looking back at examples from previous years before 2011 until 2013, student work rarely achieved the goal of architectural construction knowledge complete with material finishes. In hindsight, the reason for this lack of finish was in part due to an over ambitious multi-project schedule and, as previously mentioned, lack of construction visual guidance. Additionally, there are five principles of design that have helped this author in teaching visualization in the beginning design studio. These principles are elegance, performance-based function, few-arbitrary and adjustable parts, object self-explanation, and symbolism. These five principles, which are discussed further in the next section of this paper, as well as construction require more time in the schedule.

To compensate for this time required, the author has reduced the project to a smaller size and the number of projects to one. Also, more time is devoted in studio to technical development and finish. Reducing the schedule to revolve around a single project and intensifying the detail requirements has the positive result of maximizing student focus. The building is small enough to visualize all of the details of construction at a large enough scale where they can be seen together in a single printed drawing. This is best practice for the obvious reason that both students and professor can see

(visualize) if detail is absent, incorrect and or significantly contributing to an intended artistic effect. The detail representation requirements allow for all to diagnose problems at every level of design. This is highly beneficial because it keeps everyone on his or her toes and ensures complete understanding (Fig. 05).

Additionally, various methodologies have been used when teaching architecture and several have been integrated into the author's first and second year studio curriculum. For example, the statement of the assumptions. Defined assumptions are important for many reasons. Students need to recognize and understand what they will learn during the course and, more importantly, why they need to learn the objectives set forth. This statement of assumptions should be done in simple, clear terms. For example, the author might tell students they will need to know the thicknesses of walls and where the studs are in the wall. They must also know when it is important to show the studs in the plan and when it is unnecessary. This kind of teaching might appear trivial or nit picky. However, if the walls have stud spaced columns that connect to space beams then this information is critical to the architecture. The same can be said if special modular finish paneling is used. It is a simple, yet complex, design concept the student must understand (Fig. 06).

In the beginning, students must also be introduced to the relationships between structural components and finished building components. They must not shirk the responsibility to prove and verify architecture constructability. The author uses a case study method to explore the successes and failures of a range of example projects, both commonplace comparisons and pedigree based types. One example of verification is to evaluate beam-ends in the façade. From teaching a studio course, the author has seen the best students regularly fail to correctly show the end of a beam and the side of a beam in critical section elevation drawings. So then details are part of a formative pedagogy – a sequence of feedback loops that has in turn informed subsequent lesson plans.

The beginning design process must stem from “visualization” in order to result in an architecturally constructed final production. The process looks at the uses of quick sketch models by hand and the sketching within actual and virtual environments to test thematic alternatives. It uses ideas such as the architectural orders of construction – design thinking, systems thinking, scope thinking, containment thinking, inspired detail thinking, typical detail thinking, and “improvisational” thinking (Fig. 07) to develop sketches into buildable projects.

Principles of Architecture and Teaching Perspectives

There are principles in the field of architecture that are key to understanding its meaning. These “good principles” include elegance, performance-based function, few-arbitrary and adjustable parts, object self-explanation, and symbolism. Good, orderly principles are mutually dependent and students must learn to practice vigilance in the enforcement of architectural orders of construction. These five orderly principles can be broken into two main categories: (1) Elegance, Performance with Few Arbitrary or Adjustable Parts and (2) Self-Explanation and Symbolic. The first places emphasis on editing and simplification - uniformity and complexity together with usefulness and

service. The second refers to ideas about identity and meaning. The object appears to celebrate and represent purpose, cultural value and/or some specific and important memory memorial. The combination of the two categories is an example of art of building, or in other words, architecture. These five principles are not to be regarded as a recipe, but rather as visual guidelines.

In teaching the beginning design studio, the cultural meaning of good principles is discussed at each stage of the design process. The context of design involves practice of architecture and the licensure process. It is important that professors of architecture anticipate the practice of architecture by discussing ideas like health, safety, and welfare. It is essential to explain to students why standards and conforming principles of design ensure culture and the public good. These should be the main guiding principles behind practice. Beyond the scope of this paper, this is a discussion that is crucial to architecture as standards of conformity, as applied to building, are essential to defining what architects actually do and their value in society. It is important students learn these conforming standards and it is best they master these as early as possible. Additionally, demonstrating “goodness” using specific examples of student work, the author, in a studio setting, reciprocally aligns the representations with thinking and thinking through models.

Teaching perspectives have changed over the past several decades with changes in computing technology. These evolutions parallel critical changes in design education that the author often uses as a mode of pedagogical inquiry. Advanced computing is now affordable. This change, particularly with students having free software to use, allows much more precision in details and in representation of various options to test and resolve. The available software also can lead to further expansion of the form language. This expansion is both a blessing and a curse in that it becomes harder and harder to find and ensure that there is enough common language to relate projects to each other in context. The idea of context, urban context, and community are still very real considerations for future architects. The author discusses these ideas with students and hopes that in their future they will be able to offer value-added design.

In conclusion, with the advances in computing, particularly in rendering that allows students to produce professional level products, comes the benefit that students are able to produce professional quality drawings. They are not limited by the tools available. Now students are able to think and utilize computing with a competitive advantage, to “previsualize.” This author places value on teaching hand drawing detailing in combination with digitalization. The mixture provides students with the skills and knowledge needed for thoughtful design and visualization. The use of digital tools, hand drawing, research precedents, and the creation of both physical and digital models inform the work habits and time management of students as they generate their presentations for juried reviews (Fig. 08 and 09).

Figures and tables *All images: author*

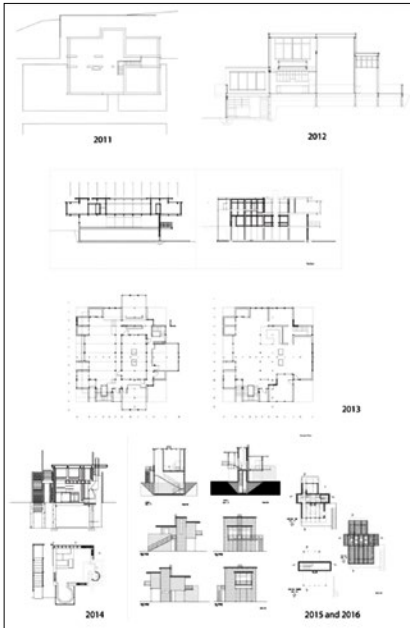

Fig. 01. Composite of student final drawings from 2016 demonstrates a greater emphasis on details. Future research will need to be undertaken to develop more precise assessment tools for learning.

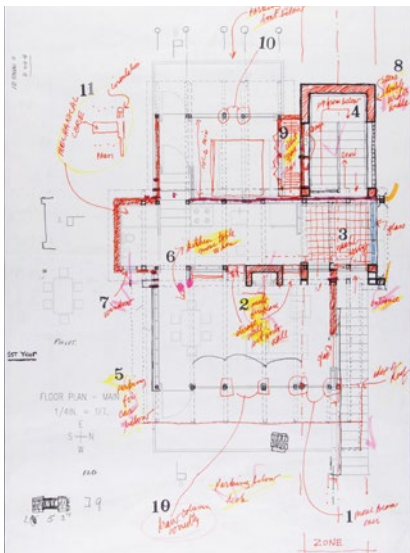

Fig. 04. Students design a small house, which receives a full technical review. Full technical reviews are hardly ever practices in education. The full technical review is taught at great length in order to balance and better focus the broader design intentions. The plan is the generator.

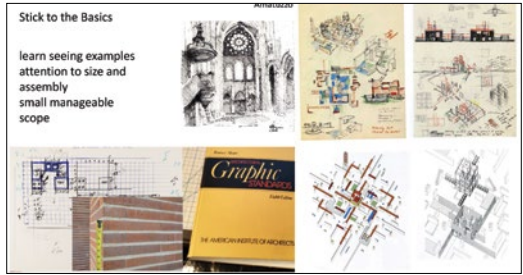

Fig. 02. Composite image of design process including graphic reference and architectural standards are necessary to combine common sense with formal and symbolic types. Beginners and experienced designers always reference standards. All design is basic design using a trial and error process.



Fig. 03. Relatively small full-scale architectural models are derived in complex 2D and 3D digital drawings using Autocad and Rhino. Rhino, Revit and Maxwell are used to learn all the necessary drawing, modeling and rendering conventions.



Fig. 07. Design reviews teach oral communication. Students need to design the best use of words combined with images.

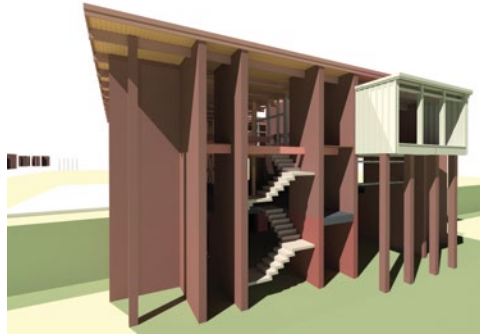
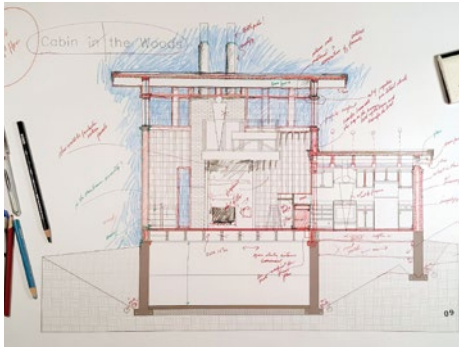

Fig. 05. (left) and Fig. 06. (right) Section and perspective are keys to representation of space form. All of the complex relationships developed in the project are represented in these views. Material qualities are tested and evaluated. Full technical reviews are essential for showing completion of a design.



Fig. 08. (left) and Fig. 09. (below) Final presentation boards teach total graphic communication of a project.



“Making Sense” – Meaning, Representation and Visualization in the Spaces of Cross-, Trans- and Interdisciplinarity

Introduction

After modernism’s “spatial turn” and more recent responses attempting to reestablish the role of time¹ the relationship between space and time in creating “place” has moved back into focus in numerous fields and disciplines. As many larger projects occur in increasingly diverse, complex and contested situations, questions of participation, ownership, representation, identity and meaning are becoming increasingly relevant and obvious. Some of the more critical positions, theories and frameworks have their origin in the critical humanities², but have been appropriated in the spatial design and planning fields. While this can be considered a move towards a more reflective and critical position towards “spacemaking”, the actual application of theories and frameworks tends to be general, simplistic, formulaic, and lacking reflection and response to the particulars of the project contexts.

This paper suggests that there is a need to develop critical frameworks and “languages” that can connect and translate the often abstract concepts and insights from critical humanities to the theories and practices of intentional spatial change with their emphasis on visualization and representation. “Translation” has a long tradition in design fields: ideas are translated into drawings and models and from there into build form. However, this tradition has tended to emphasizing the visual (the designed space’s appearance) over other forms of sensorial experience. It is decidedly at odds with Berleant’s definition of aesthetics as complex human-environment relationships over time, not just as normative visual practice, and proposed as everyday “aesthetic experience”, in particular as the ability to interact with spatial – material conditions change over different scales of time.³ Everyday aesthetics are a process central to human’s ability to construct meaning of and in relation to the spaces they interact with, and are involved in the individual and cultural formation of identities.⁴

The advance of new, digital tools and technologies for visualization and

¹ See e.g. Ingold 2000.

² e.g. Lefebvre 1991, DeCerteau 1984

³ See Berleant 1992.

⁴ e.g. Cosgrove 1998, Best & Kellner 1999, Kellner 1998.

representation presents both opportunity and necessity to critically inquire into fundamental questions of materiality, media, making and representation in spatial design and planning fields. Beyond observations on the “digital-analog divide”, the discourses in architecture, landscape architecture, and other physical design and planning fields have largely avoided more critical investigations of the “old” and “new” representational technologies beyond their ability to engage different qualities of the objects and conditions to be changed.

This paper argues that the roles of technologies go much deeper and affect the very ways by which design thinking, processes and practices evolve and form the basis for how spatial design and planning fields see and organize themselves, raising questions of professional ethics, views on the nature, culture and future of design, architecture, and other fields of creative practice.

Technologies of visualization and representation have been critically discussed in the context of knowledge production, and representation in the sciences⁵ and humanities.⁶ Expanding on these discourses, this paper inquires into the use of representational media in the design processes in inherently cross-, trans- and interdisciplinary fields such as architecture, planning and landscape architecture.

Seeing, Visualizing and ‘Making Sense’

The acts of representation and visualization spatial design is relying on operate in the larger contexts of the “visual turn”, visual culture and scopic regimes.⁷ Mirzoeff’s contention that we “interact more and more with totally constructed visual experiences”⁸ has mostly been discussed outside of spatial design fields. Constructed visualizations, such as different drawing and physical modeling conventions have been well explored and critiqued within spatial design disciplines,⁹ and there is an underlying assumption that the “constructedness”, the system of signification that establishes and governs the relationship between what is represented (reality, or the “signified”) and the representation (the representational object, or the “sign”) is well understood, fundamental to all discourse, and a precondition to participating in the process of designing. This paper argues that this assertion is assumptive, and that the new breed of digital tools and visualizations is continually and increasingly eroding and subverting this fundamental understanding.

Digital tools, in particular software that simulates and visualizes spatial-material outcomes are considerably more capable than traditional media: they are faster and more convincing in visualizing complex situations in response to varied inputs. While more substantiated and more “realistic” visualizations of alternative imagined realities *should* lead to better informed and comprehensive discourses, resulting in a deeper understanding of the complex realities that are being manipulated, there is no

⁵ e.g. Hacking 1983, Latour and Woolgar 1986, Latour 1990, Kaiser 2005.

⁶ e.g. Rose 2007, Cosgrove 1996.

⁷ See Rose 2007, Mirzoeff 1998, Cosgrove 1996, Haraway 1991.

⁸ Mirzoeff 1998, p.125

⁹ See e.g. Bosselmann 1998, Corner 1992, Cosgrove 1996, Leatherbarrow 1998, Langhorst 2010, 2012, Treib 2008.

evidence to support this contention – quite possibly the opposite is true.¹⁰ Nor have the increased capabilities of such tools resulted in projects and build work that are visually, spatially, materially and functionally superior.

Baudrillard, Debord and others have argued that the modern connection between knowing and seeing has been stretched to the breaking point¹¹ – largely due to the ability of modern visual media to construct visual experiences outside of actual-physical realities, contending that it is no longer possible to make convincing distinctions between the real and the virtual. Images have become detached from any certain relation to a real world, with the result that we live now in a scopic regime that is dominated by simulations, or simulacra, ultimately culminating in a “hyperreality” where the signs (simulacra) replace what they signify (reality) instead of referencing it.¹²

Spatial design disciplines have long argued that they remain immune to the “seduction of hyperreality” and “spectacle” as they retain privileged knowledge about the “constructedness” of the simulacra and are de facto its authors. However, the aforementioned digital tools hold the danger of generating similar “hyperreal” scopic regimes within the spatial design disciplines. In traditional media, e.g. drawing, the very process of translation between reality and simulacrum is visible, every step consciously and knowingly enacted (both physically and conceptually), controlled and (ideally) reflected on by the designer. The digital tools discussed here effectively replace the designers’ understanding and deliberation with predetermined, unknown algorithms; the opacity of their operations are effectively masking the relationship between input and output, excluding designers from critical participation. Digital tools “bundle” multiple steps and operations, so that the incremental change that is typically enacted in drawing becomes imperceptible. This enables a focus on the final “design” and its visual qualities (the ‘appearance’), at the expense of understanding the interactions between the proposed change and its contexts (the ‘performance’). The compelling character of these visualizations and the comparative ease with which they can be generated through software operations tends to suspend criticism and leads to an a-priori acceptance of the software output, evidenced by a striking homogeneity of renderings and build form across a wide range of projects and contexts (e.g. buildings that resemble massing diagrams generated in SketchUp), or worse, by spatial-material outcomes that are not attainable (e.g. material qualities rendered in 3DStudioMax that cannot be reproduced off the screen or print).

Such tools render something that is less (or even mis-)understood in a visually more compelling manner, replacing the designers’ critical vision with a total (and spectacular) visualization, ultimately limiting the designers role and letting the tools’ (unknown) biases and limitations delineate what can and cannot be engaged in a design discourse.

The following axioms attempt to delineate lines of critical enquiry to be

¹⁰ See Langhorst 2010 and 2012, Danahy 2004, Corner 1999 and 1992, Bosselmann 1998,, Broudy 1989, Baudrillard 1983, Debord 1967.

¹¹ Rose. 2007. p. 4. See also Baudrillard 1983 and Debord 1967.

¹² See in particular Baudrillard 1983

addressed in order to develop practices of visualization and representation that can operate ethically and critically as a language within increasingly visual discourses on intentional spatial, environmental and cultural change.

Axiom 1: Designing, Seeing, Understanding and Knowing

The discourses on the agency of drawing, and other forms of visualization, has mostly focused on its ability to re-present spatial-material conditions to audiences other than the designer-self, and undoubtedly it is often the rendering that “sells” a proposal or project, its appearance in renderings being what people experience, what they respond to and what they use as the fundamental information to deliberate.

The even more insidious agency of representational tools and digital tools in particular precedes the moment in which a design proposal is presented to an audience for information, deliberation and/or decision: The designer is using the same tools to understand the existing situation and conditions and to develop potential alternatives. These operations are simulations, what-if scenarios, that project future outcomes based on understanding the conditions and processes that generated the status quo (existing), and the nature and impact of the proposed changes. Carl Steinitz¹³ developed a conceptual model of spatial design and planning processes, providing a general overview over the logic and argumentative structure inherent in all design processes.

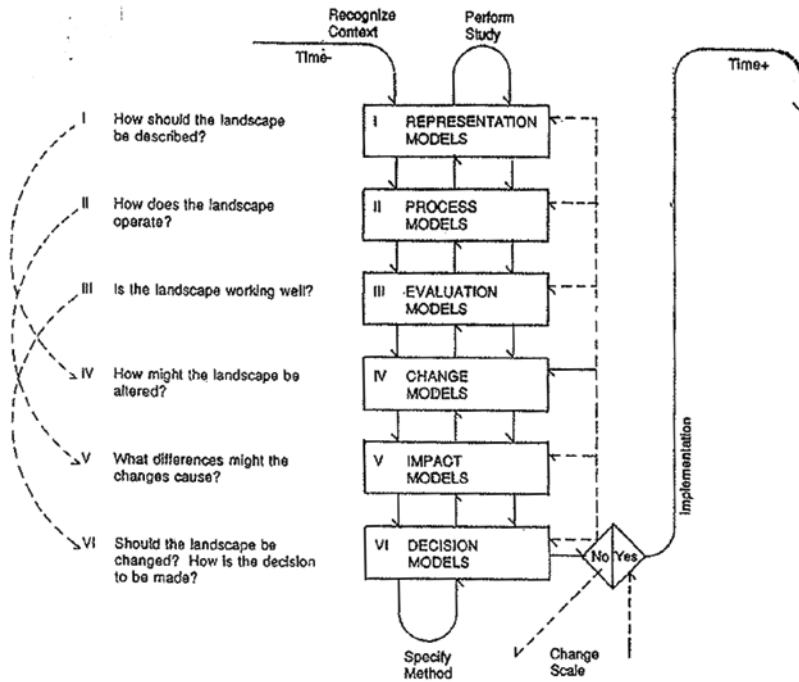

Fig. 01. A Framework for the Processes of Spatial Design and Planning.
(adapted from Steinitz 1990 and 1995).

¹³ Steinitz’ framework is based on an investigation of over 140 different iconic designs, mostly from the field of Landscape Architecture. See Steinitz 1990 and 1995.

Based on the assumption that both conditions and processes need to be investigated and manipulated in order to change existing situations into preferred ones, particular models are used to understand the current and proposed status in terms of conditions (representation models and change models) and processes (change models and impact models). Steinitz conceptualizes design proposals as what-if scenarios (he calls them “alternative future scenarios”). What-if then describes the proposed changes (the “inputs”), and the anticipated results are then calculated, de- or inducted, imagined, or otherwise derived.

In the context of spatial design it is critical to remember that the manipulation of physical space is but one aspect, and that all spatial design needs to understand the networks of complex, dynamic, nested, interrelated systems, and their respective processes and actors it operates within. As the direct engagement of existing situations and systems (the “full-scale real-time mock-up) might be inadvisable (based on the precautionary principle) or impossible, design relies on simulations: The simulations used in spatial design and planning tend to be graphic, locating specific conditions, qualities and processes in space and time and mostly employing maps and other projection drawings.

Axiom 2: Stepping Back, or Ocular Centrism and the Construction of Landscape and Space

Cosgrove argues that the notion of space and landscape emerged during the Italian Renaissance, privileging vision as a way to understand space. This ocular centrism persisted with the “practical appropriation of space of survey and mapping, designed pastoral estates, and weapons of war, employing the principles of Euclidian geometry, an outgrowth of the Scientific Revolution and the study of optics.”¹⁴ The techniques of linear perspective and other projection drawings play a critical and pervasive role, operating as geometric constructions that were rational and repeatable, articulating space as seen from a single and immobile eye. Perspectives and other projection drawings operate as an “ideological system that imparts a sense of control,”¹⁵ imparting a sense of mastery over that space, typically by members of privileged classes. The technique of linear perspective was so convincing and practical in portraying what was taken as the real world that it persists today, with criticism not occurring until the nineteenth century.

Treib considers planar projections as the “generating force” behind a design, but faults them for the “rarified view beyond typical experience”¹⁶ that renders them illegible to many people.

The rational construction and objective character of projection drawings furthered a Cartesian understanding of space as static, objective, detached, distant and abstract rather than lived, deprivileging bodily experience, and mostly exclusive of the dynamic change that characterized spatial and landscape systems.

In its broadest terms, representation is the means by which humans refer to

¹⁴ Cosgrove, ,1985. p. 46.

¹⁵ Ibid., p. 48.

¹⁶ Treib, 2008. p. 115.

realities or their perceptual manifestations as a function of what they know about them or, more precisely, of what they are interested in, reducing complex realities to what they value.¹⁷ Representations are tools that are used to ‘make sense’ of the world around us, but also to construct a collective identity that uses a shared ‘sense’ to discern us from others.

If then, as argued above, representations and visualizations are the only discursive language to imagine, propose, critique and decide on intentional change, there is an inherent need to lay open and expose the biases, values, and cultural constructions – whether they operate within a modern construct of the relationship between seeing and true knowing, or in a postmodern construct of simulacrum or hyperreality that stretches this relationship to the breaking point.

Axiom 3: The Value of Better, or on the (Practical) Impossibility of Objectivity

Design in itself is a process of valuing, of ‘making sense’, and underlying values and modalities are often deeply encoded or hidden (intentionally or unintentionally) in representations and visualizations. Rose suggests to investigate three aspects (or “sites”) of visual materials: the site of production (how a visual object is made), the site of the image (what a visual object “looks like”), and the site of audiencing (how a visual object is seen).¹⁸

The critique of any design proposal tends to focus on its “content”, on concerns about appearance or function. This critique relies on the fundamental assumption that all participants in that discourse agree on what the visual materials presented ‘mean’, assuming that they all make identical (or at least similar) sense to everybody. This becomes often contentious, even within expert communities, but even more so where non-expert communities with diverse backgrounds are involved. The assertion of the “correct” interpretation of the visual material then becomes a question of social power, tied to the possession of expert knowledge and the association with political, cultural and economic elites. The modalities of the production of visual material are usually shrouded in opacity – at least for non-expert audiences. On the site of production, the question of intentionality is one that is often circumvented by the designer – often images or other visual objects are not chosen for the knowledge they might communicate, but for a particular effect on an anticipated audience. This clearly raises ethical concerns, but also reveals the entanglement of the three sites of production, image and audiencing, and of the technological, compositional and social modalities that operate in and in between these three sites.¹⁹ The ‘making of sense’, within all three sites, might then be subservient to the manufacturing of consent, as illustrated by claims about designer’s inadvertent complicity in agendas that increase patterns of uneven development, and social and environmental injustice, even in projects that have had a generally positive reception, such as the High Line in New York City.

The discourse on what constitutes “better”, or “preferred”²⁰ are frequently

¹⁷ For an in-depth analysis of this argument see Akin 1982.

¹⁸ Rose, 2007.

¹⁹ Ibid., p. 13.

²⁰ The term was established by Herbert Simon (1969), defining design as attempting to transform existing into preferred situations.

involving a particular value – that of objectivity. Claims of objectivity are frequently used to suppress discourse, claiming the superiority and inarguability of objective fact to determine whatever “makes sense” and is – objectively- better, glossing over questions of authorship and expert vs. non-expert knowledge. Particular modes and types of visual representations, such as measured drawings, maps, charts etc. all use their association with scientific inquiry to increase the appearance of factual objectivity – a position that is inherently difficult to argue with as it makes an exclusive claim on actual-physical reality. If such visualization are generated by a computer - after all, computers are the epitome of factuality, of detachment and objectivity - the appearance of objectivity is even increased.

Axiom 4: The Wizard Behind the Curtain

The ability of software to perform complex algorithms and process vast amounts of data is undisputed. There is also an inherent trust in the technology to get it “just right all the time”, and for many applications, computers are trusted more than humans. Barely ever is a GIS map or a Rhinoceros/Grashopper simulation disputed in a public hearing. The machinic character²¹ and apparent objectivity give visual form to nothing less than reality itself, hiding the human authorship of the mechanism (hardware/software, algorithm), data, and input (the what-if) from the audience. The site of production is rendered opaque and as a locus of indisputable authority, impacting discourse and the production of critical and collective knowledge. Designers themselves have tried to hide their process from the audience for fear of losing their (mystical) status as an expert by making their knowledge and process accessible, and hence disputable. Digital tools in this context are not merely tools, but have authority, they camouflage the site of production, obscure the actual (human) authorship, thus subverting accountability of the human authors.

Axiom 5: Objectivity without Neutrality, or, Living with the Anthropocentric Dilemma

Working in a way that is objective, value-free and only concerned with scientific facts and practicalities is neither as reassuringly safe, obvious or self-evident as many would think, nor might it be possible. The dictum that “value statements are subjective” and therefore cannot possibly be based on fact, and that “statements of fact are capable of being objectively true,”²² a leftover from logical positivism has insidious staying power. Midgley critiques objectivity’s “cult of the fact” and close relationship with science, finding the that “the power of science and technology impresses us so deeply that we are not much surprised by the claim that scientific methods ought to be extended to cover the rest of our thought”. Spatial design is engaging in what she calls “many desperate attempts today in other studies (...) to make themselves ever more ‘scientific’”.²³ There is a long history of attempts to reduce the design process to pure science so that it would “not be held back ever again by individual values, opinions,

²¹ For elaboration on the concept of the „machinic” see Haraway 1990..

²² Putnam 2002, p. 1

²³ Midgley, 2001, p. 37

or personal ‘creativity’”²⁴ Ian McHarg’s dictum that he wanted to be so objective that any man, assembling the same evidence, would come to the same conclusion is still influential in spatial design and planning fields, and the linear process of SAD (survey, analysis, design) continues to be the standard. This fetishizes the designer’s presumed neutrality, a clear-sighted gaze that puts aside knowledge, social and cultural influences and suspends value judgments, while the empirical “facts” are collected, measured and recorded, ignoring “our large stock of both valuations and descriptions.”²⁵ GIS and spatial simulation software operate precisely under these assumptions, resulting in professionally produced plans that contribute to a perceived neutrality of the design process, as they are “unequivocally stable, accurate, indisputable mirrors of reality, providing the logical basis for future decision making”, rather than “highly artificial and fallible constructions, virtual abstractions,”²⁶ precluding any critical and creative engagement of the site conditions, processes and contexts through an interpretive and culturally defined investigation.

Axiom 6: Between Uncertainty and Undecidability, or between precisely open-ended and vaguely loose

Spatial design operates in complex, dynamic, multi-systemic contexts. While many physical conditions, and even some of the processes within those contexts and systems can be measured or precisely described, the description and projection of system responses to assumed inputs remains fraught with uncertainty. These projections are the realm of geospatial and parametric simulation software. GIS and Grasshopper/Rhinoceros output spatial conditions, rendered as maps and other projections, from data and algorithms. Berrizbeitia critiqued “how landscape architectural theory has oversimplified, albeit unintentionally, the landscape’s inherent complexity”²⁷ and the inherent uncertainty in projecting systems. The lack of data as well as a lack of knowledge about the behavior of individual and multiple, nested systems with and without external inputs is the root cause. This puts the designer’s prediction of the effects of future conditions and performances into the territory of speculation. She describes two possible approaches to modeling such complex systems: vaguely loose and precisely open-ended. While a vaguely loose understanding acknowledges that systems will respond somehow to inputs, precisely open-ended defines a range of possible response to inputs. The conscious engagement of both approaches requires considerable reflection on the side of the designer. GIS or parametric software is theoretically capable of system behavior modeling based on different assumptions, but both come with a complex set of defaults that make numerous assumptions and presume a high level of precision. This becomes obviously problematic when the actual understanding of a system’s behavior or performance, or the data format, is less precise than the algorithms the software uses, generating precise renderings of future conditions that are rooted in vaguely loose assumptions and imprecise data,

²⁴ Broadbent, 1988, p. 321.

²⁵ Putnam, 2002, p. 61.

²⁶ Corner, 1999, p. 251.

²⁷ Berrizbeitia, 2002, p. 117.

mismatching the precision of visual outputs with the precision of the underlying understanding.

Conclusion, or how to not get lost in datascares:

In an age and context where discourses on intentional spatial, environmental and cultural change have become increasingly visual, the development of representational and visualization practices that are inclusive and empowering, and, first and foremost, allow for a critical engagement of all the inherent, intrinsic and contextual aspects of a design process and proposal by all the people and communities involved. While this should apply to both digital and non-digital tools, digital tools in particular, allow for an even more mediated (and removed) experience and understanding of the situations, conditions and processes to be manipulated within the design process. Beyond, the mediation by digital tools comes with hidden processes, values, agendas and assumptions embedded in the software defaults, defaults that due to the apparent speed and ease of producing compelling visual objects (often in the form of seductive “datascares”), are neither noticed nor critically interrogated.

“The architects, engineers, and city designers trained in the design of cities acquire the skills necessary to represent what exists and what might become reality. But because the richness and complexity of the real world cannot be completely represented, they must, out of necessity, select from reality an abstraction of actual conditions.... What they choose to represent influences their view of reality and very significantly defines the outcomes of designs and plans, and thus the future form of cities.”²⁸

The limits and biases of representational media and the resultant visual objects have significant implications for the public and how designed spaces are conceived, produced and ultimately experienced and used. A meaningful participation in these and other forms of cultural production requires visual-representational practices that make as clear as possible their underlying values and assumptions instead of hiding and encoding them. They should operate as tools that empower and facilitate understanding and imagination, and not merely to manipulate visual realities to manufacture consent with hegemonic agendas.

Bibliography and References

- Akin, Omar. (1982). Representation and Architecture. In O. Akin & E. F. Weinel (Eds.), *Representation and Architecture* Silver Spring, Maryland: Carnegie-Mellon University. 1982, p. 5-11.
- Baudrillard, Jean. *Simulations*. New York: Semiotexte. 1983.
- Berleant, Arnold. *The Aesthetics Of Environment*. Philadelphia, PA: Temple University Press. 1992.
- Berrizbeitia, Anita. Scales of Undecidability. In; Czerniak, J. (ed.), *CASE: Downview Park Toronto*. Munich: Prestel. 2001. p.116-125.
- Best, Steven, & Kellner, Douglas. “Debord and the Postmodern Turn: New

²⁸ Bosselmann, 1998. p. xiii.

- Stages of the Spectacle". *Substance* #90. 1999. p 129-156.
- Bosselmann, Peter. *Representation of Places: Reality and Realism in City Design*. Berkeley: University of California Press. 1998.
- Broadbent, Geoffrey *Design in Architecture: Architecture and the Human Sciences*. Letchworth: David Fulton. 1988.
- Broudy, Harry S. *The Role of Imagery in Learning*. Oxford/New York: Oxford University Press. 1989.
- Corner, James. "Representation and Landscape: Drawing and Making in the Landscape Medium". *Word and Image* 8(3). 1992. p. 243-275.
- Corner, James. "The Agency of Mapping. Speculation, Critique and Invention". In Cosgrove, Denis. (ed.). *Mappings*. London: Reaction Books, 1999. p. 251-316.
- Cosgrove, Denis. (1985). "Prospect, Perspective and the Evolution of the Landscape Idea". *Transactions of the Institute of British Geographers*, 10(1), 1985. p. 46-62.
- Cosgrove, Denis. *Social Formation and Symbolic Landscape*. Madison: University of Wisconsin Press. 1998.
- Danahy, John. W. "Dynamic Immersive Visualization: Negotiating Landscape Images". In M. Koll-Schretzenmayr, M. Keiner & G. Nussbaumer (eds.), *The real and the virtual worlds of spatial planning*. New York: Springer. 2004.
- Debord, Guy. *La Societe' du Spectacle*. Paris: editions Buchet-Chastel. 1967.
- DeCerteau, Michel. *The Practice Of Everyday Life*. Berkeley: University of California. 1984.
- Hacking, Ian. *Representing and Intervening, Introductory Topics in the Philosophy of Natural Science*. Cambridge: Cambridge University Press. 1983.
- Haraway, Donna. *Simians, Cyborgs, and Women: The Reinvention of Nature*. New York: Routledge. 1991.
- Ingold, Tim. "The Temporality of Landscape." In *The Perception of The Environment. Essays on Livelihood, Dwelling and Skill*, Tim Ingold (ed.). London: Routledge, 2000. p. 189-208.
- Kaiser, David. (ed). *Pedagogy and the Practice of Science: Historical and Contemporary Perspectives*. Cambridge: MIT Press. 2005.
- Kellner, Douglas. "Multiple Literacies and Critical Pedagogy in a Multicultural Society." *Educational Theory* 48(1). 1998. p. 103-22.
- Langhorst, Joern. "Rendering the Unseen: The Pragmatics, Aesthetics and Ethics of Place Representation". *Proceedings of the Design Communication Association Biannual Conference*, Oklahoma State University, Stillwater, OK. 2012. p. 209-218.
- Langhorst, Joern. Between a Rock and a Hard Place: On the Dialectics of Landscape and Representation. *Representation. Journal of the Design Communication Association*, 2010. P. 128-134.
- Latour, Bruno. "Visualization and Cognition: Thinking with Eyes and Hands".

- in Lynch, M. and Woolgar, S. (eds). *Representation in Scientific Activity*. Cambridge: MIT Press. 1990. P.19-68.
- Latour, Bruno. and Steve Woolgar. *Laboratory Life – The Construction of Scientific Facts*, New York: Princeton University Press. 1986.
- Leatherbarrow, David. “Showing What Otherwise Hides Itself.” *Harvard Design Magazine* 6, 1998. p. 51-52.
- Lefebvre, Henri. *The Production of Space*. Oxford: Blackwell. 1991.
- Midgley, Mary. *Science and Poetry*. London and New York: Routledge. 2001.
- Mirzoeff, Nicholas. “What is Visual Culture?” in Mirzoeff, Nicholas (ed.). *The Visual Culture Reader*. London: Routledge. 1998.
- Putnam, Hilary. *The Collapse of the Fact/Value Dichotomy and Other Essays*. Cambridge, MA: Harvard University Press. 2002.
- Rose, Gillian. *Visual Methodologies. An Introduction to the Interpretation of Visual Materials*. London: Sage Publications. 2007.
- Simon, Herbert. *The Sciences of the Artificial*. Cambridge: The MIT Press. 1969.
- Steinitz, Carl. “A Framework for Theory Applicable to the Education of Landscape Architects (and Other Environmental Design Professionals)”. *Landscape Journal* 9(2), 1990. p. 136-143.
- Treib, Marc. (ed.). *Representing Landscape Architecture*. New York: Taylor & Francis. 2008.

Lohren Deeg ^a, Sean Burns ^b

^a Department of Urban Planning, College of Architecture and Planning, Ball State University, Muncie Indiana, USA, ^b Department of Architecture, College of Architecture and Planning, Ball State University, Muncie, Indiana, USA

Interpretation, metaphor, and constraint as vehicles for communicating space, time, and meaning

Introduction

Capturing a message of meaning as contained in the milieu of the contemporary city and its architecture presents new challenges for a student often classified as a digital native. As a response, the authors of this study have embarked to use music and gaming as vehicles to engage students in processes of abstraction, analysis, interpretation, and craft. The sense of time and meaning, as embodied in instrumental music and the ancient game of chess, were chosen to challenge design students to develop ideas of associated with sequential space and city form. Our methods included a number of exercises to visualize music, literature reviews of historic precedents, mapping and providing contextual information in field study, and surveying student reactions. Structured methods of traditional representation and drawing assisted the construction of physical models and communicated aspects of space, time, and meaning for the student.

A translation of music into a limited vocabulary of points, lines, and planes

As part of their first semester of study in the field of environmental design, students were given a project that embraced a limited and elemental vocabulary of point, line, plane, and volume as a means to translate a piece of instrumental music into a spatially defined passageway within a confined framework. Students were asked to consider the elements as a sequential series of informed components as a means to capture a series of spaces that at times may constrict, swell, or shift in direction within the predefined framework. To minimize the occurrence of preconceived elements such as stairs, ceilings, and floors, the passageway was to be conceived as a gravity-free environment, thus promoting concepts of compression and release in place of ascension and descent.

The inclusion of music as a thematic inspiration for the project offered the students both a series of constraints and strategies as they began diagramming their initial interpretations of the given selection towards the physical embodiment of the

music into defined spatial passage. As stated by Michael Benedikt, “...architecture and music are made of materials – more or less raw - which are given such peculiarly human attention in their preparation, arrangement, and presentation, that they transcend nature as well as the found or accidental.” (Benedikt 2014). The spatial experience of the given instrumental music is inspired by the structural arrangement of the music and driven by the student’s interpretation of its presentation (Fig. 01). Musical concepts such as rhythm, tempo, pitch, and transitions have a dependency on time and offer a design language to the students as they begin their translation of the instrumental music to a 3-dimensional passage.

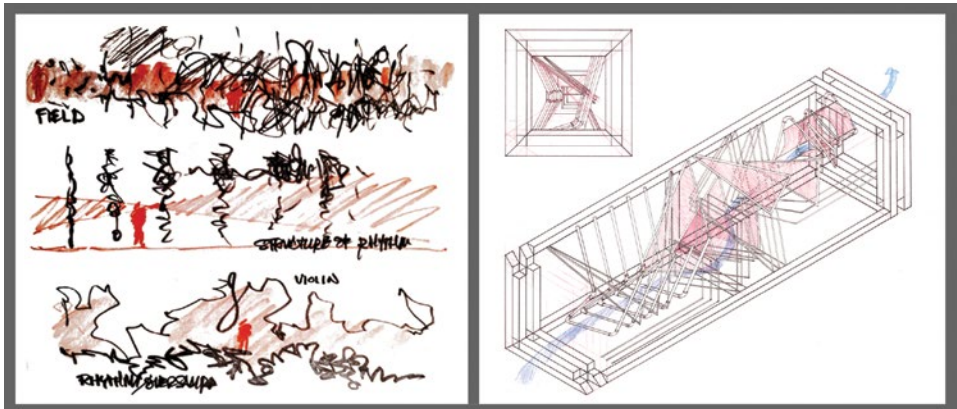

Fig. 01. Illustration of ideas for project from (left) initial concept translation sketches of instrumental music by primary author, (right) representation of final spatial definition of spatial passage by student Max Jolly.

Source: Scans by primary author and graduate assistant.

As commented by student Jake White, “The project allowed me to explore music in a whole new manner, giving me the chance to manifest the rises, falls, tone, and texture of something with no physical existence. This process gave me awareness into the design of everything and how there is nothing that cannot teach a designer something new.” (White, 2017).

Upon being presented with the project, the didactic question arose for the students to consider: Is the intent to tell the story of the translation through the elemental objects of point, line, and plane, or through the space and flows within these arranged elements? As the project is a representational environment and not an object intended to be seen from afar, space and movement among the elements is of primary importance in telling the story of the music’s interpretive translation by the students. Laura Chiesa poses the question of how the abstraction of space and flows might be a storytelling agent. Chiesa argues that we are able to trace a trajectory through space and storytelling because of our associations with the terms: space as implying abstraction and universality, and storytelling referring to something very singular in nature. This trajectory, “allows for a set of spatial stages where backdrop and foreground, plot, (narrative), and characters are interspersed and meshed.” (Chiesa 2016). As the students begin to design their translated story of the instrumental music as a spatial construct, they often employ two initial approaches: one that focuses on

the creation of volumetric centers, or swells, along the passage and then develops the transitions between these centers, or an approach that embraces the development and manipulation of a spine that reacts to the various translated information and directly confronts, dictates, and affects the movement of the user through the defined path.

Andrew Ballantyne teaches us that our views and feelings of processes, objects, and organizations are dependent on the scale relationship of these topics and ourselves. Further, the scale of which something is made might at times promote a meaning and expression, where at a different scale, it may actively suppress this same expression (Ballantyne 2012). At the conclusion of the project, students are asked to consider how the changing of scale for their physical models might affect the meaning of how they use point, line, and plane to create a defined volume. The students are asked to reconsider definition of a spatial passageway by shifting the scale of the project from the representative environmental condition of their design to that of 1:1. Criteria are then given to the students to construct a collective portal out of the series of projects that relates directly to that of the human scale, thus introducing a new associative meaning to the project as they work collectively to define and capture space using the original elemental vocabulary of point, line, plane, and volume (fig. 2).

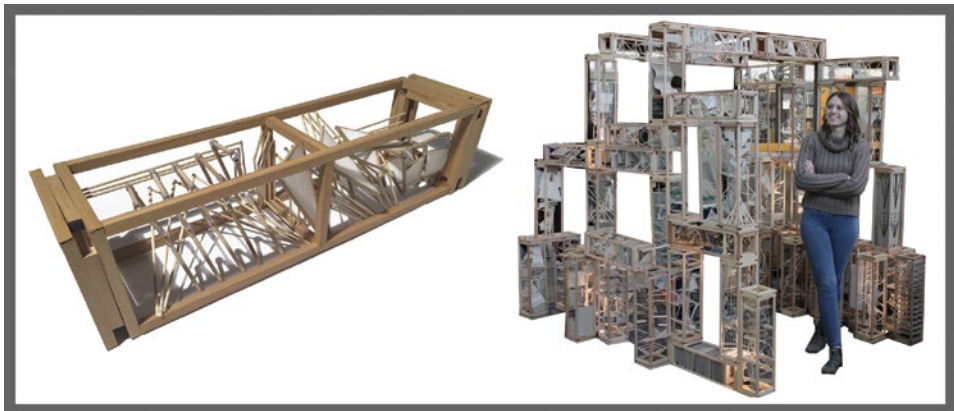

Fig. 02. A montage of student work showing a change in meaning of the project based on a shift in scale from that of the (left) representative environmental condition to that of (right) the 1:1 human-scale installation using point, line, and plane to capture volume.

Source: Photos by secondary author.

A translation of precedents into the typologies of a chess set

The game of chess is one of the most recognizable products of civilization. The Chicago skyline, as a home to many distinctive high-rise buildings, is an intersection of design and planning across multiple scales and epochs (fig. 3). Students were challenged to examine how the pieces, the game-board, and the rules associated with the game of chess could potentially embody the variety of designers and planners who shaped the city of Chicago and the trajectory of environmental design across approximately a 150-year period. Students could then recognize the city skyline as a design project that evolves over a period of time. The meaning of these individual

expressions then can be read as part of the meaning of a collective whole and a city's overall visual and physical identity.



Fig. 03. (Left) The Chicago Model exhibit of the Chicago Architecture Foundation. (Center) A portion of the Chicago city skyline. Many skyscrapers bear resemblance to the tripartite division found in a Staunton chess set. (Right) Balusters as bollard streetscape fixtures found in Muncie, Indiana, resembling the pawns of the Staunton set.

Source: Photos by primary author.

Students were introduced to a brief history of chess sets, ranging from archaeological findings dating from 12th century Scotland, through to the 19th century legacy of British writer Howard Staunton, who endorsed the general design of the sets we often see today. Students were then assigned to perform literature and image review of six personalities who practiced in Chicago to influence the design for six piece typologies found in a standard chess set. Students chose at random six names from a list of fifty personalities associated with Chicago architecture, landscape architecture, urban planning, or public art. Given Chicago's noted heritage and tradition of tall buildings, students were asked to consider the potential role of tripartite division of form. As observed, the traditional Staunton chess sets possess similar divisions, becoming a vehicle for discovery and expression.

During the literature / image review, students were asked to sketch a pallet of details, forms, parti sketches, and pictorial interpretations from the work of the six assigned inspirations and from examples experienced in Chicago. Students then constructed a half set of pieces, using materials of their own choosing, and were challenged to document the construction process, whether using an additive, subtractive or hybrid method of craft. An emphasis on the look and feel of the pieces, balance, and whether interpretations were able to be recognized in game play were discussed.

Students were also asked to consider the assigned move behavior of each piece. Such challenges, interpretations, and learning opportunities seasoned and imbued the students' design thinking and process throughout the course of the project. Student Mark Bila shared a diagram of a typical game and used the parti diagram in a later studio project in the academic year. As Bila commented, "(This project) was the first time working at a one to one scale... Almost all of our other projects were only meant to be observed. Chess pieces are meant to be moved, handled, and felt. This brought many interesting and dynamic challenges to my design process." (Bila, 2017). Bila reinforces the differences of this project amongst the projects in architectural education that remain solely in the form of scale models and representative drawings.

As student Jake White remarked, “The chess board project was a perfect opportunity to develop my architectural palette. When we visited Chicago, I took a new, critical eye to the styles of the many designers who contributed to the city.” During the project’s timeline, one of the more pressing challenges of the design problem became apparent: How does one design and fabricate a chess set that aesthetically works as a cohesive whole, yet still is mindful of six different personalities? White addressed this by saying: “I approached the chess board design problem by divining six designers’ styles down to three words each and creating a chess piece that incorporated each of these three words to achieve something that one of the chosen designers would appreciate” (White, 2017). This reductive process was not prescribed by the project statement; rather, it is something the student discovered in the design process in order to achieve aesthetic harmony amongst the chess pieces. Aesthetic consistency in urban design versus the architectural expression of corporate or organizational values in tall buildings is a critical issue when considering the evolution and unique identity of a city skyline. The authors believe this project modeled this conversation effectively in an accessible scenario to students.

A group wide chess game event was held to test the effectiveness of the sets and game boards. This opportunity allowed students to evaluate the durability, recognition, and practicality of their designs (fig. 4). Students were also challenged to communicate a specific impression or experience of their Chicago field studies in the design and fabrication of the chessboard; in some cases, were whimsical expressions of topography, the Chicago river, and lakefront. One student even chose to interpret the typology of the chess board vertically, as a series of shelves.



Fig. 04. (Left to right) Students engage in game play with their chess sets, spanning a number of fabrication methods. Student work showed various interpretations of the game board, including stepped, vertical, and other material expressions.

Source: Photos by primary author.

As a final step, students then made two sets of drawings. One set became the procedural story of one chess piece in isometric view, as depicted in steps. A second drawing challenged students to think of their chess pieces as a collective city skyline in frontal elevation projection. Both drawings then were rendered using a paper cut out method, placed behind a translucent sheet of vellum that contained the line art in ink. Questions about how these two layers and methods of representation stimulated discussion (fig. 5).

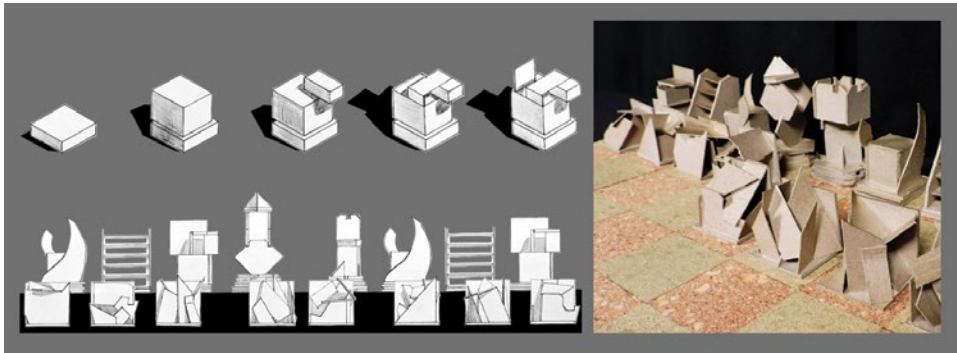

Fig. 05. A montage of student work by Madelyn Conway, including (upper left) a procedural drawing in isometric view, (lower left), an imagination of the designed chess pieces as a “city skyline” in elevation view, and (right) a student’s constructed chess set and game board.

Source: Scans and photo by primary author and graduate assistant.

Conclusion

It is hoped that the exploration of music and gaming in these two design projects shall serve as an effective vehicle of communication between notions of space, time, and meaning as embodied in two forms of art and culture that can stimulate a student’s imagination and design thinking. The authors are confident that the exploration across scales, metaphors, narratives and forms found in the contemporary city and in architectural space can create rich inquiry in the mind of the design student and form a foundation for continued dialogue between experience and representation.

Bibliography

- Ballantyne, Andrew, and Chris Smith. *Architecture in the Space of Flows*. Abingdon, Oxon,: Routledge, 2012.
- Benedikt, Michael. *Music in Architecture--architecture in Music*. Austin, TX: Center for American Architecture and Design, 2014.
- Bila, Mark. “Chess Review.” E-mail message to the primary author. April 14, 2017.
- Chiesa, Laura. *Space as Storyteller: Spatial Jumps in Architecture, Critical Theory, and Literature*. Evanston, IL: Northwestern University Press, 2016.
- Kloos, Maarten, Machiel Spaan, and Klaas De Jong. *Music, Space and Architecture*. Amsterdam: Amsterdam Academy of Architecture, 2012.
- Ripley, Colin, Marco Polo, and Arthur Wigglesworth. *In the Place of Sound: Architecture, Music, Acoustics*. Newcastle, UK: Cambridge Scholars Pub., 2007.
- White, Jake. “Chess Board Project.” E-mail message to primary author. April 14, 2017.
- White, Jake. “Instrumental Music Translation Project.” E-mail message to primary author. April 14, 2017.

Building Posture: Glasgow School of Art's Driven Voids of Light and Body Dynamics

Abstract

This paper is an attempt to build a meaningful relationship between architecture, structure and body dynamics using the recently constructed Reid Building at the Glasgow School of Art as a case study. We argue that space, time and meaning in architecture are poetically crafted by the thorough understanding of the relationship between body dynamics and architecture through the physical performance in traditional Japanese martial arts and the role of structural analogies in the making of architecture. We used both analogical reasoning and personal experience in both domains of architecture and martial arts as a reflective research method. The story of making the Reid Building supports our argument as we compare it to the structure, strength, and body dynamics.

Introduction

The Reid Building, which was completed in April 2014, is the recent addition to the 1909 Glasgow School of Art iconic building by Charles Rennie Mackintosh. Designed by Steven Holl Architects and Engineered by Ove Arup & Partners, the project was conceived through an international competition for a new school of design. The new building program includes studios for art, design, and architecture, lecture hall, seminar rooms, cafe, exhibition, and academic administrative spaces. Since the beginning, the design of the project was conceived through a series of sectional drawings and models, measured against detailed drawings of the Mackintosh Building (the MACK).

Holl's first watercolor sketch of the building dated 6/22/09 showed a straight vertical element cuts through multiple floors and appeared to be a void that connects studios both horizontally and vertically. A later sketch titled 'structure/material' 'complementary contrast' and dated 11/1/10 signed as SH/CM (Steven Holl & Chris McVoy) indicates a multi-story sectional drawing with a slightly slanted shaft (void) towards the Renfrew Street, inserted through the floors and cuts across a seven-story vertical section of the building, two of which under the ground level (figure 1). The three slanted voids penetrating the building was conceived as five meters diameter concrete cylinders, tilted 12 degrees from the South. A description by Steven

Holl Architects read as follows: “Driven voids of light allow for the integration of structure, spatial modulation, and light. The “driven void” light shafts deliver natural light through the depth of the building providing direct connectivity to the outside world through the changing intensity and color of the sky. Also, they provide vertical circulation through the building, eliminating the need for air conditioning.”

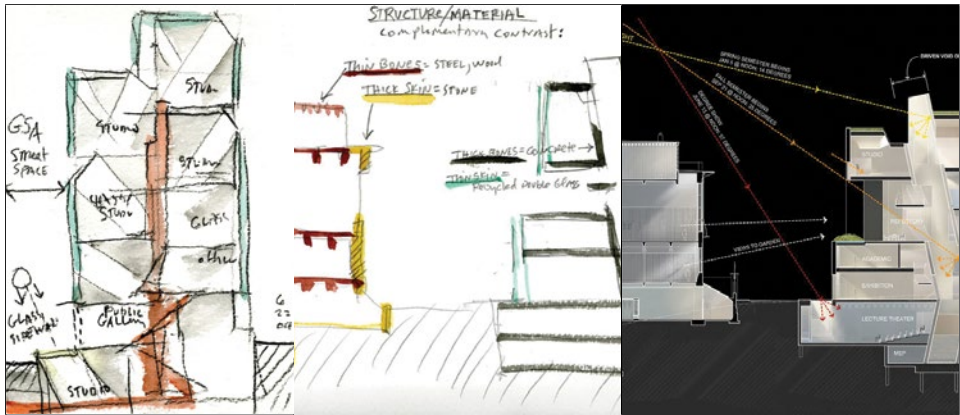

Fig. 01. Development Stages for the Voids of Light of the Reid Building at the GSA.

Source: Steven Holl Architects.

Ove Arup & Partners, the engineer of record for the project, called the driven voids of light “a sculptural form of perforated inclined tubes” and stated that Arup had several technical challenges to overcome including large overhangs (cantilevering above the Assembly Building), complex geometries, and a deep basement. Ove Arup also emphasized the role of the shafts in circulating fresh air to the studios and bringing in daylight. As for the structural role of the voids, Arup stated “Driven voids of light act monolithically with the wall lines, with each uniquely defined and cut, to deliver extensive overhangs to the south façade. The overhangs, combined with the inclination of the voids, promote a significant gravity slew, inclining the building towards the Mackintosh.”

Much later design development of the driven voids of light appeared in a rendered sectional drawing of the seven-story building. The shafts changed direction at the threshold where the building meets the ground, and instead of a straight shaft driven away from the MACK, an “elbow-like” shaft broke the continuity and reversed back at the ground level. Chris McVoy, in a public lecture at Texas A&M University, mentioned that the change of the shafts’ direction was based on a suggestion from the structural engineer to provide more support and stability to the building. Much earlier at the inaugural lecture of the Reid Building, McVoy credited Derek Roberts, a lead structural engineer at Arup with the elbow idea. According to Arup Journal, published in February 2014, the reason for shifting was “for greater structural and cost efficiency; an “elbow” was introduced into the voids at ground level turning the cylindrical structures back on themselves to help counter the slew with some centering of the load at foundation level.” Derek Roberts was listed among several other authors of an article on the Reid Building including Greg Hardie, Gavin Kerr, Lee Kirby, Dan

Lister, Andrew McDowell, and Andy Sheppard (Hardie et al., 2014). According to Arup, finite elements modeling and analysis was essential to understand the behavior of the voids' extraordinary role in holding the building together (figure 2).

Structural Analogies

Holl and Arup's use of the elbow analogy in reference to the voids of light is known as "structural analogy". Literature suggests that there are two types of analogies: surface analogy and deep analogy. The deep analogy is, in fact, the same as the structural analogy, which is according to Hernan Casakin "*involve a system of higher order relations that are based on deep properties of a familiar situation.*" Casakin noted that analogies between two different domains are likely to be successful due to the common shared correlations based on similar structural aspects (Casakin, 2004). In contrary to metaphor, Hey et.al stated that analogy is often used during the ideation phase of design to generate concepts and to find solutions to the design problem. Framing the design problem or understanding it could use metaphors as inspiration (Hey, Linsey, Agogino, & Wood, 2008). Tomà Berlanda, in his book, *Architectural Topographies*, blends metaphors and analogies as he referred to how buildings meet the ground. He used a set of well-known architectural precedents to illustrate four conditions of how buildings meet the ground: Feet on the ground, anchoring, roots and clouds. Berlanda further explained that in most occasions, the repetitive use of metaphors ends by depriving them of their relevance. Further, it gives little indications as to the tangible and pragmatic approaches to the encounter with the earth (Berlanda, 2014).



Fig. 02. Driven Voids of Light during construction for the Reid Building at the GSA.

Source: Steven Holl Architects.

So, what architecture has to do with the structural analogy of the elbow or body dynamics? And is there a relationship between how our bodies move, building structure, and constructive meanings? Eastern philosophy and in particular traditional Japanese martial arts could perhaps provide some answers to our inquiry as stated by Funakoshi Gichin (1868-1957), the founder of Shotokan Karate, an Okinawan school

known for being very hard, direct and linear, but focuses more on the form of body and techniques. The core of Shotokan practice is to produce maximum force in the least amount of space, with the least effort and the best condition for the purpose, including stance, posture, technique trajectory, and line of energy, which is included in the final form of execution. Funakoshi's last disciple, the late Nishiyama Sensei, taught us the hidden principals of understanding body dynamics. For example, in 'Age Uke,' a rising block, the center of the wrist should be in line with the center of the head, and one fist forward and up from the forehead; the elbow should be at ear level and inside the bodyline. Elbow movement is minimal, and elbow points down when elbow stops it serves as a center of action to elbow extension, and forearm snap at the elbow (figure 3).

Nishiyama gave an explanation of what constitute as the correct execution of "Age-Uke" as follows: *"With the elbow bent about 90 degrees, swing arm upward, keeping it close to the body. As arm passes in front of the body, twist inward, then snap upward and focus at a point about three inches out from the top of forehead. At this point, the thumb should be downward. The point of contact should be directly in front of the vertical center of the body. Simultaneous with the up-swing of the blocking arm, cross opposite hand in front of the mouth and withdraw it firmly to the ready position."* (Nishiyama & Brown, 1960). Nishiyama further added that to perfect the form and technique of 'age-uke,' one should avoid lifting the shoulder of the blocking arm because this makes it difficult to tense the muscles of the chest and weakens the block. Also, one should avoid raising the elbow to a point higher than the blocking hand as this will be ineffective in blocking the attack. If one swings the elbow beyond the side of the body, this will make it difficult to concentrate the strength of the body at the point of impact (figure 3).

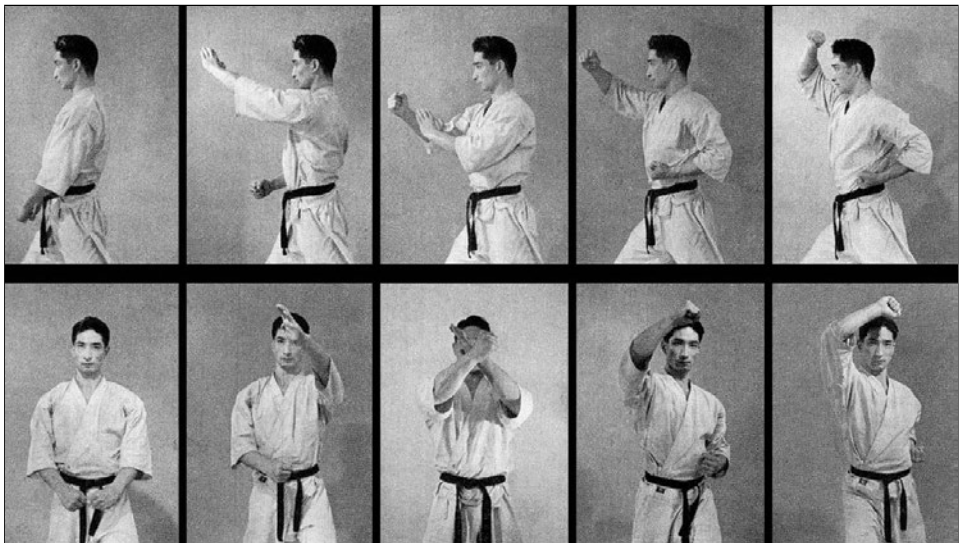

Fig. 03. Nishiyama Sensei Demonstrating the 'age-uke' Rising Block Technique.

Source: (Nishiyama & Brown, 1960).

Building Posture

Strength, force and correct execution of form in martial arts are ultimately generated by body posture and understanding the line of energy. In architecture, we raise the question if buildings should also have a posture that may explain issues of strength, structure, and balance. Paul Emmons referred in his article, to posture studies known as body mechanics including the body, like buildings, as part of static mechanics. Emmons noted that body posture used to be a measure of health; therefore poor posture was called “inefficient,” following the prevailing mechanic view of the body. Much of Emmons’ observations on the relationship between the design of the Payne Whitney Gymnasium at Yale University in 1932 and its designer, John Russel Pope is fascinating. Pope’s understanding of the human body was reflected in his design to the point that the building itself was finely calibrated to produce perfect posture in its students (Emmons, 1999).

Body dynamics are described as the movement around the spine as an axis and around the body core (center). Understanding body dynamics in traditional Japanese martial arts is fundamentally critical to the efficient and effective execution of power and forces. Body dynamics including contraction and expansion of muscles are the sources of producing power (force) in the minimum action space. Body dynamics, as developed in Eastern thoughts, consist of six actions that might be referred to as rotation, vibration, shifting, pendulum, rising, and dropping. Traditional martial arts practitioners (Karateka) are required to continually work on perfecting their techniques through the full understanding and execution of these six actions.

Florin Diacu used mathematics and physics to analyze body dynamics in traditional Japanese martial arts to draw conclusions on the efficiency of several techniques. While the rising block “age-uke” was not one of the seven analyzed ones, other studies on moves could be sufficient to explain our argument. Diacu developed a formula to understand the relationship between several factors including the mass, the height of the body, the gravitational acceleration, the velocity of the fist, and the angular velocity of the fist’s rotation. Diacu drew several conclusions among of which indicating that the greater the mass, the higher the energy. Diacu gave an example of the street fighters, who often engage most of their body mass in a punch at the expense of losing their balance. However, the Karateka (traditional Japanese martial arts practitioner) chooses to use less mass to favor stability (Diacu, 2003)

Santiago Calatrava is also known for his studies of body postures as a source of inspiration for his buildings and bridges. Calatrava’s analysis of animals, birds, and the human body are however explicit in his work. The reader of Calatrava’s work can easily distinguish bones, joints, spines, and literal translation from body movement to architecture.

Meeting the Ground (Anchoring)

The physical and material relationship between construction and ground are of critical discourse in architecture. Building posture and structural analogies as noted, provide the foundation of this discourse. Tomà Berlanda presented several case studies of prominent work of architecture to illustrate how the earth is touched by buildings. Berlanda expressly acknowledged Holl's attention to the relationship between architecture and ground since the late 1970s and his continuous struggle in developing that relationship in his later work (Berlanda, 2014). Holl, also in his book defines anchoring as the intention to reconfigure the existing topography of a site to receive a new intervention of a new building. (Holl, 1991). Holl emphasized that architecture is bound to the situation and the site of a building is more than a mere ingredient in its conception. Holl described the site as the physical and metaphysical foundation of a building. Beyond the physical conditions for the site to receive a building or the building to meet the site, Holl stressed that the experiential connections and the need for a metaphysical link between the building and the site are integral. He stated: "*Today the link between site and architecture must be found in new ways, which are part of a constructive transformation in modern life*" (Holl, 1991) Although anchoring acts as a central phenomena in Holl's work as evident in his Reid Building, intertwining, as another phenomenological concept, captured further investigations of the metaphysical aspects of his work. (Holl, 1998)

Robert Franklin, in his thesis, explored the relationship between body and architectural drawing. Franklin transformed the lessons learned in the tectonic of one's body to discover integral logic in the design of the building. Franklin again used the term "posture" in describing his work and how his building touches the ground by stating that "*The building postures itself between old and new, and has minimal disruption to its surrounding environment. The new structure delicately touches the ground in a concentrated point load along an orthogonal grid slightly skewed from the original.*" (Franklin, 2004)

The relationship between posture, structural analogies, and anchoring establish the framework of strength in both body and building. Dennis Bartram elaborated on the concept of 'strength' and distinguished in his article between Western thoughts and Eastern ones. This difference in philosophy of strength is expressed in the difference of approach in combat sports. Bartram affirmed that it is not until 1960 were when the Western mind was introduced to the construction concepts of Biotensgrity by Kenneth Snelson and Buckminster Fuller. Strength in Eastern philosophy generated by the energy flows from deep within the structure out to the tips of the fingers and toes (Bartram, 2005). A description that profoundly illustrates how the Reid building establish its strength through the positioning of its driven voids of light (figure 4).

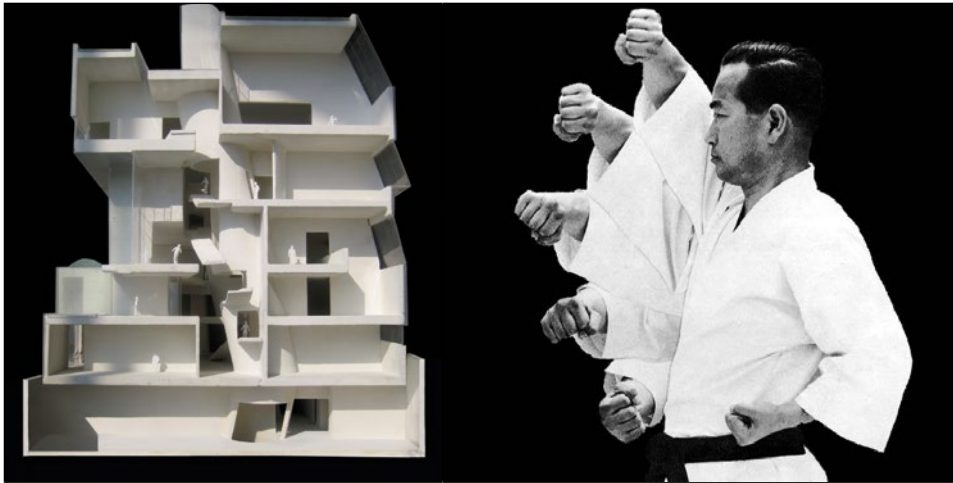

Fig. 04. A model section of the Reid Building and the 'age-uke' Rising Block Technique.

Source: Steven Holl and (Nishiyama & Brown, 1960).

Conclusion

Steven Holl, as described by Rowan Moore in his article in the Guardian, has a reputation as one of the more poetic of American architects, who have based designs on the music of Bartók, the paintings of Klee and the phenomenological philosophy of Maurice Merleau-Ponty. Neither Holl nor McVoy has publicly based the design of the Reid Building on body dynamics or traditional Japanese martial arts. Moore, who criticized the design of Holl before construction in another article, after visiting the building, criticized the driven voids of light again and said: *“the “driven voids” are not quite the emissaries of the celestial that they are meant to be, rather conceptual devices with which the architects, as architects, sometimes do, seem to have become over-obsessed. They compete with other light sources, and they obstruct flow as much as they permit it. Contradiction can be a valuable part of the architecture, but here it feels accidental.”* Moore in the same article criticized Calatrava as well in losing reality of construction. He said: *“It is also possible for architects to be so entranced by their fluent brushstrokes that they lose touch with some of the realities of their construction projects. This might be seen, for example, in the work of Santiago Calatrava, who as well as designs for buildings regularly produces watercolors of bulls and ecstatic women.”* (Moore, 2014).

Despite Moore's criticism, Holl's work in the Reid building convincingly conforms to the laws of physics and nature. While it is unnecessary for buildings to mimic nature, as the case with Calatrava, implicit structural analogies such as the Reid Building's elbow, profoundly employ nature's mode of operation and therefore it cares less about explicit translation from biology to architecture. Further explanation and evidence of such critical discourse beg the question of the relationship between body dynamics and architecture. The driven voids of light act not only as a structural core that support the building and anchor it to the ground, but also as the building's

arteries where air circulate and natural light penetrate the building. Adding to the analogy of body posture yet another layer of poetic proposition to the correlation between body and buildings.

Bibliography

- Bartram, Dennis. (2005). BioTensegrity – body mechanics. Retrieved from <https://rodgericketts.wordpress.com/tag/dennis-bartram/>
- Berlanda, Tomà. (2014). *Architectural topographies : a graphic lexicon of how buildings touch the ground*. New York: Routledge.
- Casakin, Hernan. (2004). Visual analogy as a cognitive strategy in the design process: Expert versus novice performance. *Journal of Design Research*, 4(2), 124.
- Diacu, Florin. (2003). Martial Arts and Math: On the Dynamics of Karate. *High School Mathematics Magazine Pi in the Sky*(6), 9-11.
- Emmons, Paul. (1999). *The Right Angles: Constructing Upright Posture and the Orthographic View*. Paper presented at the Legacy + aspirations : considering the future of architectural education: proceedings of the 87th ACSA Annual Meeting, Washington, D.C.
- Franklin, Robert D. (2004). *Architectural Postures: a proposed education center of nature for rock creek park*. (Master of Architecture), Virginia Tech, Washington-Alexandria Architecture Center Alexandria, Virginia.
- Hardie, Greg, Kerr, Gavin, Kirby, Lee, Lister, Dan, McDowell, Andrew, Roberts, Derek, & Sheppard, Andy. (2014). The Reid Building, Glasgow School of Art. *The Arup Journal*(2), 86-103.
- Hey, Jonathan, Linsey, Julie, Agogino, Alice M, & Wood, Kristin L. (2008). Analogies and metaphors in creative design. *International Journal of Engineering Education*, 24(2), 283.
- Holl, Steven. (1991). *Anchoring : selected projects, 1975-1991* (3rd ed.). New York, NY: Princeton Architectural Press.
- Holl, Steven. (1998). *Intertwining : selected projects 1989-1995*. New York: Princeton Architectural Press.
- Moore, Rowan. (2014, March 1, 2014). Reid Building review – Mackintosh's 1909 Glasgow School of Art has a new neighbour *theguardian*. Retrieved from <https://www.theguardian.com/artanddesign/2014/mar/02/reid-building-review-mackintosh-glasgow-school-art-steven-holl - comments>
- Nishiyama, Hidetaka, & Brown, Richard C. (1960). *Karate, the art of "empty hand" fighting* (1st ed.). Tokyo, Rutland, Vt.,: C. E. Tuttle Co.

A Form-Function-Use (FFU) model to simulate human behavior in built environments

Abstract

Current building modeling tools, including popular BIM (Building Information Modeling) systems, provide a static representation of buildings, which neglects dynamic aspects concerning how people will use a building after it has been realized. Consequently, during the design process, architects are required to fill this informational gap with their own knowledge and assumptions, based on precedents drawn from other projects, which may apply only partially to new design contexts. To address this issue, we propose to augment digital building models with information pertaining to their function, and use. Function consists in a set of attributes that reflect how a space can be used, by whom, and under which circumstances. Use is the result of the dynamic interaction between a building, its expected users, and their goal-oriented activities. In this work, we propose a simulation framework able to represent form, function and use. We demonstrate the method in the context of hospital environments, where the dynamic relationship between human behavior and the built environment are difficult to be anticipated during the design phase.

Introduction

Prediction and evaluation of the future expected performance of buildings is of cardinal importance for architects and their clients¹. But because of their size and cost of construction, buildings cannot be prototyped—they are a prototype of themselves. If the architect makes a mistake that is not recognized during design time, it can only be corrected at great cost, or not at all. To overcome this problem, architects have been using different kind of representational means to predict and evaluate various building performances. They could thus contemplate alternative design solutions, involve more people in the decision-making process, and evaluate the desirability of potential outcomes.

The advent of Computer-Aided Design (CAD) in the 1960s enabled the development of digital building representations that support geometric modeling and

¹ Kalay, Yehuda E. *Architecture's New Media: Principles, Theories, and Methods of Computer-Aided Design*. MIT Press. 2004.

photo realistic image rendering. Other types of prediction and evaluation, such as structural analysis and energy prediction, required the use of multiple, separate external databases to augment the model and avail it to analysis programs. The emergence of BIM (Building Information Modeling) at the end of the 20th Century added much needed non-graphical data to the formerly mostly geometric representation tools, supporting in an integrated way different kind of analyses, including cost, energy, light, acoustics, and structure.

Despite these advancements, current building models fail to represent how a building will actually be used by its occupants prior to its construction and occupation. Instead, to address this important type of performance, architects mostly rely on their personal knowledge, which is often biased, and on accumulated experiences gleaned from prior case studies and post-occupancy evaluations (POE), documented in the form of codes and regulations. These methods ignore the dynamic and stochastic nature of human activities and the site-specificity of building projects: a building that performed well for one community of users, at a given location, may not work well for a different community of users, at a different time and location.

We propose a more comprehensive representation model that can support prediction and evaluation of how people use buildings. Such representation considers not only the *form* of the building, but also its *function* and its *use*. We demonstrate the proposed approach in the context of hospital environments. Designing hospitals is a complicated task because of the wide range of users and the variety of functions that are carried out in the same location. Still, hospitals also demonstrate a high level of formalization, which is advantageous for the purposes of our research: it provides a comprehensive and agreed-upon set of use-processes on which to test the model.

Relevant studies

The importance of architectural models has been recognized for more than 2,500 years. First came physical scale models, which were often crude and imprecise approximations of the actual building. The invention of scale drawings and perspective rendering in the 15th Century, as means for design conception, representation, and communication, allowed architects to conceive and represent buildings on paper before they were committed to timber and stone. They could thus contemplate alternatives design solutions, involve more people in the decision-making process, and evaluate the desirability of potential outcomes.

The advent of CAD in the 1960s allowed architects to further evolve the representational means at their disposal, mostly in terms of photo-realism and control over detail. The emergence of BIM the dawn of the 21st Century added non-graphical data to the formerly mostly geometric representation. In BIM systems, buildings are modelled as an aggregation of objects, describing various components such as beams, slabs, walls, windows, doors, etc. Such models have been primarily used to produce building analyses in terms of cost, structure, acoustics, and illuminance, which represent the relationships of the building with different physical phenomena such as temperature, light, wind, and gravity. In this work, we focus on a different kind of analysis, one that investigates how people use buildings. Analyses of this kind require

not only a model of the building and its physical parts, but also of the semantics of buildings, their intended users, and a series of activities they will perform².

To address this issue, research efforts have been directed to expand building models with information about the activities performed in space^{3,4,5}. A configurational approach has been proposed by Hillier & Hanson⁶ to analyze people movement in spaces using a graph-based representation that measures spatial relations and connectivity. Multi-agent systems have also been developed to simulate specific aspects of human behavior, such as pedestrian movement⁷, egress situations⁸, activity schedules in office buildings⁹, and scheduled and unscheduled activities in hospital buildings¹⁰. The latter model is centered on the concept of Events—computational entities that direct the behavior of multiple agents in space.

We propose an advanced building representation that supports multi-agent simulations like the one proposed in Schaumann et al.⁰. The model encodes information about Form, Function, and Use to support the simulation and analysis of how people use buildings. The paper expands on these three components, which have been previously introduced by Kalay et al.¹¹, and illustrates an application of the method in the context of hospital environments.

The Form-Function-Use Model

In this section, we describe the Form-Function-Use model, and its components. Tab.01 summarizes key features of the model.

² Simeone, Davide; Schaumann, Davide; Kalay, Yehuda E.; Carrara, Gianfranco. “Adding users’ dimension to BIM”. Milan: *EAEA conference*. 2013. p. 483-490.

³ Eastman, Charles M. & Siabiris, Anastassios. “A generic building product model incorporating building type information”. *Automation in Construction*. no. 4. Vol. 4. 1995. p. 283–304.

⁴ Ekholm, A. Modelling of user activities in building design. *Architectural Information Management*. Helsinki: ECAADE. 2001. p. 67-72.

⁵ Kim, Tae Wan; Rajagopal, Ram; Fischer, Martin; Kam, Calvin. “A knowledge-based framework for automated space-use analysis.” *Automation in Construction*. vol 32. 2013. p. 165-176.

⁶ Hillier, Bill; Hanson, Julianne *The Social Logic of Space*. Cambridge University Press. 1984.

⁷ Kapadia, Mubbasir, & Badler, Norman I. “Navigation and steering for autonomous virtual humans.” *Wiley Interdisciplinary Reviews: Cognitive Science*. no. 4. vol. 3. 2013. p. 263-272.

⁸ Chu, Mei Ling; Parigi, Paolo; Law, Kincho; Latombe, Jean Claude. “SAFEgress: A Flexible Platform to Study the Effect of Human and Social Behaviors on Egress Performance.” Tampa: *Proceedings of the SimAUD conference*. 2014. p. 35-42.

⁹ Goldstein, Rhys; Tessier, Alex; Khan, Azam. 2011. “Space layout in occupant behavior simulation.” *Proceedings of IBPSA-AIRAH Building Simulation Conference*. p. 1073–1080.

¹⁰ Schaumann, Davide; Kalay, Yehuda E.; Hong, Seung Wan; Simeone, Davide Simulating Human Behavior in not-yet Built Environments by means of Event-based Narratives. Washington DC: *Proceedings of the SimAUD conference*. 2015. p. 7-14.

¹¹ Kalay, Yehuda E.; Schaumann, Davide; Hong, Seung Wan; Simeone, Davide. Beyond BIM: next-generation building information modeling, to support form, function, and use of buildings. In Kensek, Karen, and Noble, Douglas (eds.) *Building information modeling: BIM in current and future practice*. John Wiley & Sons. 2014.

Table 01. Description of key model features

	Form	Function	Use
Questions	What does it look like? What is it made of?	What is it? What does it mean? How it can be used?	Who uses it? How is it used? When is it used? For how long?
Model Attributes	Geometry Topology Materials	Semantics Affordances	Detect Users & Activities in space Define current use
Dependency	Physical qualities	Social agreement Building program	Building operation Spatio-temporal conditions Social factors

Form

In the proposed approach, *Form* describes the characteristics of a building and its parts, including its shape, position in space and materials. It represents architectural elements that are both physical (e.g. walls, windows, columns, floors, and so on) and non-physical (e.g. rooms, courtyards, corridors), including the spatial/topological relationships between them. *Form* can be modeled using existing BIM tools, which provide a systematic digital representation of objects, and the relationship among them. Fig.01 provides an example of such model.

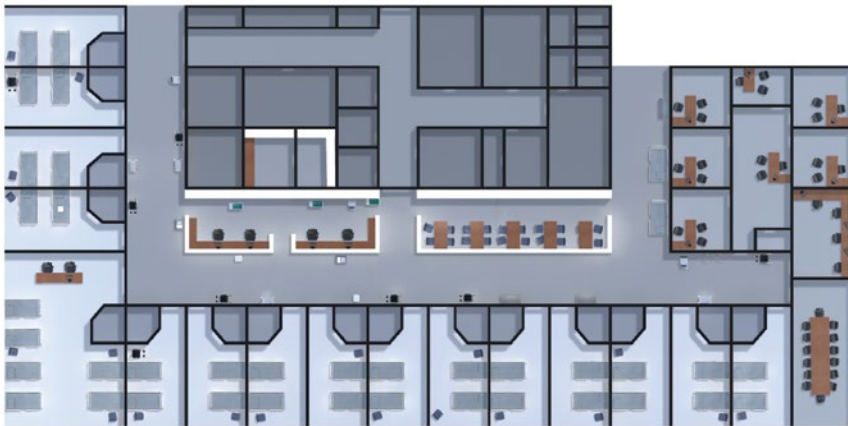

Fig. 01. Space model with *form* attributes

Function

Function is a set of conceptual attributes that add *meaning* (semantics) to form characteristics. It describes how an object can be used, for what purpose, and within which context¹¹. In architectural design, *function* is often represented as the building programme, which reflects the goals and desires of a client in terms of building specifications. *Function* is independent on *Form*, because different ‘forms’ can serve the same function: consider for instance a design competition, where architects compete to generate the best form that will respond to a specific building programme.

Conversely, the same ‘form’ can have different functions: historic buildings maintain the same form over decades while changing their function.

BIM models do not explicitly represent function. Instead, they rely on the assumption that the professionals who use the model all share a common understanding, and therefore will interpret the meaning of the represented objects in similar ways. This assumption is fundamentally flawed, as building stakeholders often include professionals from different domains. For example, in the case of a hospital, they include architects, doctors, nurses, administrators, lawyers, lay people, etc., each with a different view of the world, and a different interpretation of the building model.

To overcome this representational deficiency, we model *function* in terms of particular semantic values associated with each space¹², which describes how it can be used, and under what conditions (e.g. patient room, nurse station, corridor, etc.). This semantic information assigns to each space a list of affordances^{13,14} describing possible context-dependent uses. For instance, a “patient room” may be associated with the following affordances: “clinic”, “social”, “private”, “assistance”, which are *activated* based on the users present in the room, and the activities they perform. The activation of a specific affordance determines how a space it is currently used. It also stipulates which other affordances are supported in the same space, therefore allowing or inhibiting other behaviors. For instance, a patient room that is used as *clinic* during a doctor’s visit, prevents visitors from using the same space for *social* purposes, such as for talking with the patient. Fig.02 provides an example of *function* attributes that can be associated to a space model.

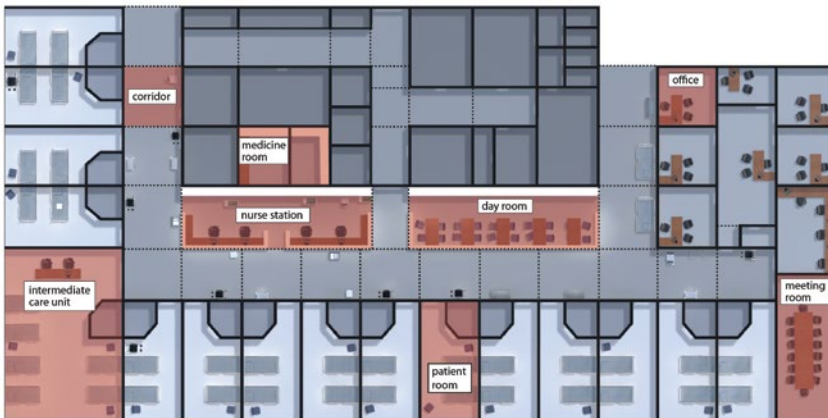

Fig. 02. Examples of *function* attributes

¹² Brodeschi, Michal; Putievsky Pilosof, Nirit; Kalay, Yehuda E. “The definition of semantic of spaces in virtual built environments oriented to BIM implementation”. Celani, Gabriela; Sperling, David M.; Franco, Juarez M. S. (eds.). *The next city*. San Paulo: CAAD Futures. 2015. p. 331-346.

¹³ Norman, Donald A. “Affordance, conventions, and design.” *Interactions*. no. 6. vol. 3. 1999. p. 38-43.

¹⁴ Gibson, James Jerome. *The Ecological Approach to Visual Perception*. Lawrence Erlbaum Assoc. Hillsdale, New Jersey. 1979.

Use

Use is a property that adds time-based, socio-cultural information to the represented artefact. It emerges from the interaction between the object and its user. The *use* model requires an advanced description of the building *users*, the *activities* they perform, the *spaces* they inhabit, and the *events* they are involved in. *User* models describe an occupant's functional role (e.g. doctor, nurse, visitor, secretary), characteristics (age, gender), dynamic status (tiredness, stress), and preferences¹⁵. *Activities* describe a set of scheduled procedures (e.g. a doctors' round) or unscheduled procedures (e.g. the social interactions between patients and visitors). *Spaces* encode information about their form, function, and current use, including who are the actors involved, what do they do, and what is the current "use" of the space and the available affordances. *Events* are computational entities that coordinate the convergence of *users* in *space* to perform specific *activities*¹⁶. Different from Agent-based models, where agents (users) are equipped with independent decision-making abilities, Events dictate what agents should do in specific circumstances. Hence, they afford a higher-level view than an individual agent has, and can therefore coherently coordinate the actions of multiple agents that depend on one another. For example, a "patient check" event ensures that a nurse, a doctor, and a patient convene at a specific location (e.g., the patient's room) at the same time, and will commence only after they have all arrived. Another Event may direct a group of visitors to talk with a patient.

While performing, Events monitor the current state of the world (e.g. the state of the users involved, or the space in which they are located) to determine whether a necessary set of conditions prevail. For instance, an Event coordinating the social interactions between a visitor and a patient needs to monitor that the space in which the users are located (in this case a patient room) currently supports "social" activities. This would be the case, for instance, if no doctors are currently located in the room. The eventual presence of a group of doctors and nurses would cause the space semantics to become "clinic", hindering the performing of any "social" activities, including the social interactions between patients and visitors. In this case, the social interaction Event will include provisions what to do, such as directing the visitors to move to the corridor and wait for the conclusion of the medical treatment.

Fig.03 illustrates an example of such scenario: in part (a), a group of doctors and nurses performing a doctors' round enter a patient room, while a group of visitors socialize with a patient in the adjacent room; in part (b) the medical staff enters the room where the visitors are located, causing a change in the room semantics, which in turn causes the visitors to leave and wait in the corridor.

¹⁵ Sopher, Hadas; Schaumann, Davide; Kalay Yehuda E. "Simulating Human Behavior in (un)Built Environments - Using an Actor Profiling Method". *Engineering and Technology International Journal of Computer, Electrical, Automation, Control and Information Engineering*, no. 10. vol. 12. 2016.

¹⁶ Schaumann, Davide; Kalay, Yehuda E.; Hong, Seung Wan; Simeone, Davide Simulating Human Behavior in not-yet Built Environments by means of Event-based Narratives. Washington DC: *Proceedings of the SimAUD conference*. 2015. p. 7-14.

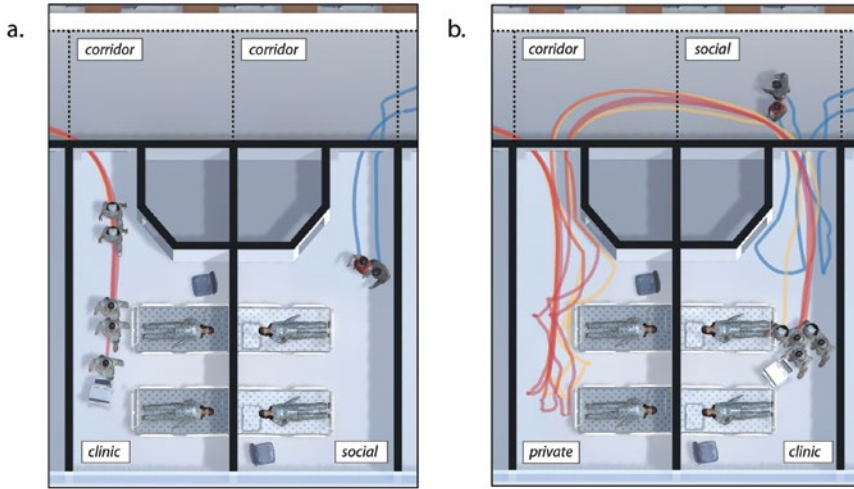

Fig. 03. Example of the dynamic change in space use

Case study

Fig.04 displays a simulation snapshot of an internal medicine ward “in use” prior to its construction. It is populated by virtual doctors, nurses, patients, visitors, and technicians, performing a variety of activities. The main activities performed involve a doctors’ round, visitors socializing with patients, and a medicine administration procedure. The movement of each actor is traced using colored lines (*red* for doctors, *orange* for nurses, *blue* for visitors).

The simulation reveals the mutual impact of people and a built environment. It shows how the design of a built environment affects the way it is used by its inhabitants. For instance, the lack of appropriate spaces for visitors to wait may determine the level of congestion in the ward corridors, causing delays in providing medical treatment to patients. The provision of a dayroom, instead, where visitors may spend time with patients, may alleviate that situation.

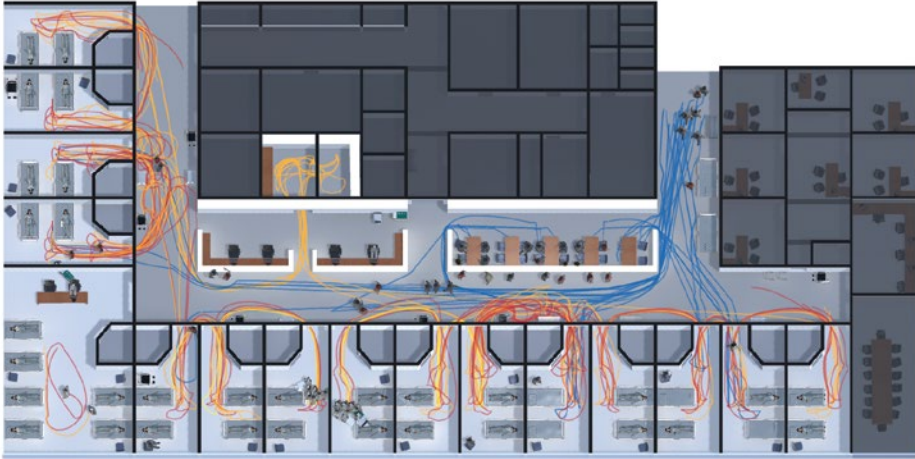

Fig. 04. Simulation of a building in use

Discussion

The proposed modelling approach enables the simulation of how people use buildings prior to their construction and occupation. Different kinds of analyses may be performed, such as measuring walking distances, the amount of time a given space is used, for what purpose, by whom, etc. Eventually, multiple design alternatives could be compared and evaluated against such metrics. We argue that the proposed system holds the potential for generating useful information that can be used in architectural design to evaluate and compare different design options as far as their use is concerned.

Acknowledgments

This research was made possible by the generous support of the European Research Council grant (FP-7 ADG 340753).

Taking a Hard Line: The Revealing Power of Functional Draughtsmanship

Introduction

*While these drawings have the potential to provoke architectural thought, they are abstractions that reveal the mathematical nature of the structure and provide a lesson in composition and careful symmetry.*¹

Research is defined by the Cambridge Dictionary as, ‘a detailed study of a subject, especially in order to discover (new) information or reach a (new) understanding’. It is a revelatory process, illuminating something which had been otherwise hidden or unknown. Creativity, on the other hand, “..refers to the potential to produce novel ideas that are task-appropriate and high in quality..”² The tools, mediums and mechanisms involved in both these activities vary enormously across the disciplines—from the printed word to the scientific laboratory; from musical instruments to the artist’s studio. Within schools of architecture, these are typically related to drawing and physical model making; traditionally using analogue modes and now in both digital as well as analogue modes. The spectrum of representation and simulation employed by students is an increasingly wide one, ranging from the traditional hand drawn sketch to sophisticated virtual and augmented reality platforms. Whilst it can be claimed that drawings are primarily a means of representation, they nevertheless also have value in their ability to be instruments of research as well.³

Background

The means by which drawings are produced by those professions with strong visual characteristics such as engineering and architecture has undergone a major revolution in the last 40 years. By the 1980’s and 90’s, computer-aided draughting (CAD) and computer-based visualisation was beginning to have a profound impact on architectural practice and the beginning of the 21st century heralded the even more

¹ Baines, Mark; Barr, John; Platt, Christopher; The Library, MSA Publications, Glasgow, 2015.

² Sternberg R.J., What is the Common Thread of Creativity? in *American Psychologist*, April 2001, p. 360.

³ Baker, N., Drawing as a Research Process and Drawings as Research Outputs-How Acceptable are they in Various Disciplines? In, *TRACEY Journal: Drawing Research* 2012, p. 16.

influential world of simulation, virtual and augmented reality, computational design and Building Information Modelling (BIM). It is perhaps too early to establish their full impact and legacy, but the evidence so far suggests it will be profound.

The sophistication of contemporary digital simulation has never been greater and more widespread in our world than it is now. We employ terms such as ‘digital culture’ and digital revolution’ in everyday conversations without perhaps fully appreciating the enormity of what this really means. The generation of students now entering university or college have had their formative childhood experiences saturated with an unprecedented wave of domestically-available digital gaming. They arrive as undergraduates having completed their ten thousand hours of ‘practice’ in becoming an expert.⁴ The expertise they have amassed is the craft of digital manipulation, learned primarily through the brain/eye/hand coordination of the computer gaming arena. Computer games in other words, have been the seducing agent in developing an entire generation’s digital Fähigkeit and in most cases, now outstrips the knowledge and skill base of their parents’ generation. That youthful digital expertise and agility is unsurpassed in the 21st century. Our societies are immersed in digital technology at home and work and nowhere more so than in the professions of design, science, contemporary art, medical visualisation and the construction and engineering industries.

Digital Tools in the Design Process

Within a design process, the role of any representation is to illuminate aspects of what is being designed—the ‘reality-in-waiting’. Whether generated by analogue or digital means, the resulting image of the un-constructed artefact is a coded piece of information, just like a painting or musical score.

Those with the knowledge to unlock the graphical code of a 2D plan of a building for example, will, at a glance, be able to understand the overall distribution of the spaces in relation to each other, without the need for further data. In a similar way, those who can unlock the code of musical notation, will understand the structure, rhythm and melody of music represented by the marks on the musical score in front of them. The term ‘reading’ a plan or ‘reading music’ accurately describes the immediacy of understanding that occurs when glancing at the coded page or drawing. When so much sophisticated 3D virtual reality is available, is there still a role for 2D hard line visualisation in the architectural design process? Hard line draughting, emphasises line and form in contrast to the more surface and atmosphere-emphasis employed in digital simulation. Surely such an historical means of representation has now been superseded forever by the seemingly infinite means of representation which digital visualisation and virtual reality offers? Given that the aim in architecture is usually to construct a 3D object, should the tools we use not always be 3D-orientated and digital in character? Much contemporary focus within Higher Education Institutes and the professions rests on new developments such as BIM, digital simulation and virtual and augmented reality questioning the purpose and relevance of drawings of any kind.

⁴ Sennett, Richard, *The Craftsman*, Penguin Books, 2008, p. 247.

*“A drawing is not there to represent reality as accurately and completely as possible. It is not a simulation....Simulation has displaced representation in architecture and society at large.”*⁵

It is increasingly common now in architectural practice for ideas to be manipulated and concretized in digital 3D reality at a much earlier stage than was previously the case in drawing-based design processes. The evolution of BIM has exacerbated this phenomenon and created an appetite for detail decision-making at an increasingly-early stage in the gestation period of an architectural project. This trend towards more certainty earlier, to be more definitive as swiftly as possible, risks obscuring the enduring truth that an image (even a hyper-realistic virtual one) is still an abstraction of a still-to-be developed-reality. The natural leanings of digital draughting is to be millimetre perfect to a degree never to be seen on a building site.

Too much detailed information hinders the push and pull process at the early stage of a design. As Juhani Pallasma has written, *“A sense of certainty, satisfaction and finality that arises too early in the (design) process can be catastrophic.”*

The Development of Technical Drawing

However, within this accelerating landscape, the sustained tradition of the hard line orthographic projection drawing continues to provide a perhaps surprising, but nevertheless highly effective tool for research exploration. The clarity and unambiguous character of the simple hard line drawing recalls the engineering draughtsmanship of the recent past. The evolution of technical drawing as we understand it, developed as a response by scientists in the sixteenth century requiring accurate drawings in the fields of astronomy, navigation, military engineering and land-surveying. Orthogonal drawings, that is drawings where all elements are drawn to scale, became the established method of illustrating building and architectural works around this time. Much later as a result of industrialisation in the 19th century, systems of minimum tolerance generated a need for detailed drawings of mechanical parts.⁶ The tradition of what might be described as rational, 2D and 3D draughting within the architectural, mechanical, aeronautical engineering and shipbuilding professions developed to serve the specific needs and requirements of design, construction, fabrication and manufacture. Within the engineering and construction professions, the particular characteristics of unambiguous, hard line drawings proved vital for the making of precise, complex three dimensional physical objects, components and machinery. This type of drawing was the *lingua franca* of all industrial manufacturing processes.

Technical Drawing as a subject was taught in secondary schools before its more recent post-war evolution into the less defined field of ‘graphic communication’ was established.

Technical drawings can be understood to have one singular intended meaning. The need for precise communication in the preparation of a functional document has

⁵ Scheer, David, Ross; *The Death of Drawing: Architecture in the Age of Simulation*, Routledge. 2014, p.20.

⁶ Hambly, M. *Drawing Instruments 1580-1980*, Sotheby’s Publications by Philip Wilson Publishers, London 1988, p.11.

always distinguished technical drawing from the expressive drawings more often associated with the visual arts. Artistic drawings are subjectively interpreted; their meanings are multiply determined. Technical drawings on the other hand require to be rational and unambiguous. They are designed to guide precise actions not to invite multiple interpretations. Those drawings used in the creation of for example, car maintenance manuals, DIY Guides, model aeroplane kits, construction and fabrication details, are there to help the reader understand a process or object or to carry out a required task in a clear and sequential manner.

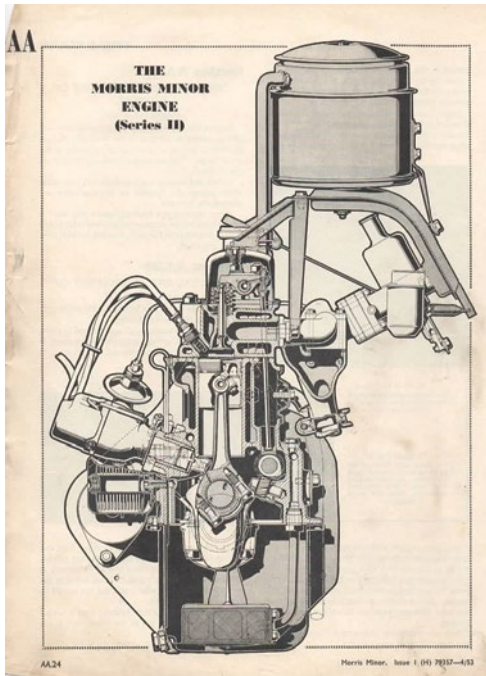

Fig. 01. The Morris Minor Engine Series II

Source: *The Morris Minor Series "MM" and Series II Workshop Manual* Issued by Morris Motors Ltd. Cowley Oxford.

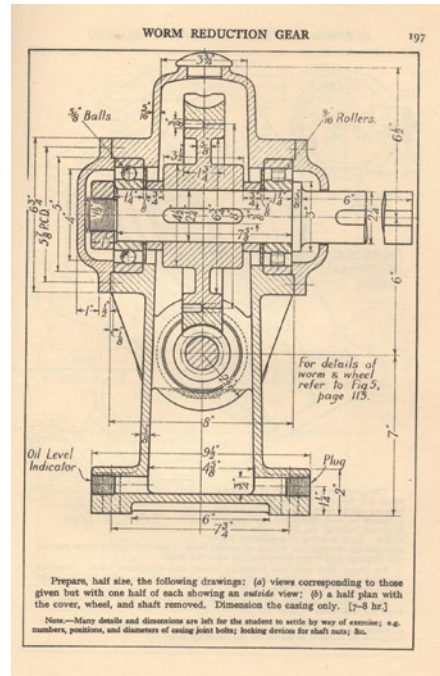

Fig. 02. Worm Reduction Gear

Source: Abbot, W., *Machine Drawings and Design: A textbook of Intermediate Standard for Engineering Students*, Blackie & Son Ltd, 5th Edition 1947, p 197.

The drawing must function as a navigation device, not a destination in itself and has a very different purpose than a drawing created for the purpose of artistic visualisation. That particular unselfconscious, matter-of-fact quality, devoid of artistic pretensions has nevertheless certain intrinsic aesthetic characteristics which have become clearer to appreciate now that we live in a world saturated with visual simulation and virtual reality. Within the field of drawings, they have that character which Le Corbusier described as ‘the Engineer’s Aesthetic’ when he documented the anonymous vernacular structures of early 20th century industrial complexes. Such drawings have also served as an inspiration for architects and designers, such as the late Sir James Stirling, RIBA Gold Medallist and Pritzker Prize recipient, who has written about the ‘elegance of functional draughtsmanship’ which he discovered from his own nautical engineer father’s engineering drawings.. I share such an appreciation

and my own father's engineering drawing books illustrating machine parts drawn in sectional axonometric also embedded in me an intrigue for such technical drawings.

My own interest also centred on the pleasure derived from their aesthetic quality as well as the joy of the activity of precision drawing itself. Whilst being unselfconsciously functional, these drawings nevertheless displayed a paired down graphic quality which I saw as fresh, elegant and objective. They are in effect, the anatomical drawings of the engineering world. What you see is what you get.

To the emerging digital generation of current undergraduate architecture students, selecting such a drawing medium by choice for a project is an intriguing decision to make, given the many options available to them. This paper explores two case study projects carried out by two small groups of undergraduate students at the Mackintosh School of Architecture in the Glasgow School of Art in 2014 and 2015 who both utilized this medium and examined its relevance as a research tool within an expanding and increasingly-sophisticated digital 3D landscape. Their work explored particular characteristics of two neighbouring buildings of architectural distinction on the GSA campus. The Glasgow School of Art Library, designed by Charles Rennie Mackintosh and the more recently completed Reid Building, by Steven Holl architects and JM architects face each other across Renfrew Street in Glasgow and are the result of very different procurement, design and realization processes. The Reid Building project examined the overall building while the Library project examined a single space.

Case Study 1: The Reid Building at the Glasgow School of Art

The Reid Building was already well-known before its construction through well-published watercolour studies by Steven Holl. Apart from these and some digital images of the design in its urban setting, no detail drawings were released by the practice prior to completion. Given Holl's emphasis on phenomenology in his work, the theme of detail, particularly those details which the public experienced when they came face to face with the architecture, seemed a pertinent topic to examine. The drawings undertaken by the students examined both key construction details as well as certain important architectural elements which visitors touch or come close to in their everyday usage of the building. They conducted their own measured studies on site which were augmented by access to some of the architects' construction drawings in the preparation of their own work.

In concentrating solely on line, outline and form, these drawings illuminate particular relationships between the parts and the whole at a macro and micro stage. The character of the construction detail drawings produced is similar to those traditional engineering drawings previously referred to. Three dimensional, cut-away studies make clear the layered construction of the external envelope, from the 'secretly-fixed' glass cladding externally, to the painted concrete walls internally.

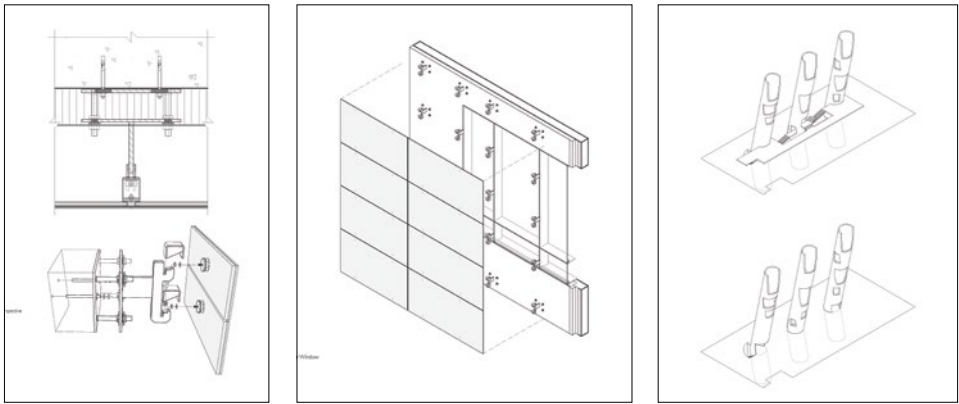

Fig. 03. (Left) Secret Fixings, Fig. 04. (Middle) Veiling, Fig. 05. (Right) Driven Voids

Source: Platt, Christopher, Carter, Brian, Baines, Mark; *Form, Fabric, Detail*, MSA Publications, 2014, p.29, p.30, p.19

These drawings identify the differing conditions of the overall structure and the building's cladding making explicit how gravity is overcome as well how a suitable dry and comfortable internal climate is achieved. Like cut-away anatomical drawings, various significant construction junctions were interrogated in this manner.

Engineering components such as the glass cladding fixing clamps are revealed as highly significant to the cladding support system, yet are all but invisible to the naked eye. One sequence of studies concentrating on the 'Driven Voids of Light' as Holl described them, deliberately illustrated them in a manner to highlight their key role in the building's structural arrangement, and how they act as monumental hollow columns as well as devices to manipulate sunlight, daylight and natural ventilation. In some drawings, the character of the building recalls the disassembled parts of an engine block- a quality also redolent of James Stirling's famous all-dimension-true axonometric drawings⁷.

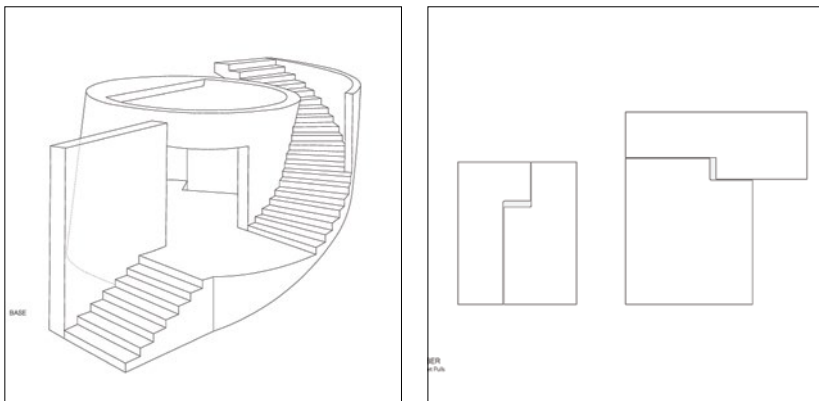

Fig. 06. (Left) Staircase Base, Fig. 07. (Right) Timber Cabinet Pulls

Source: Platt, Christopher, Carter, Brian, Baines, Mark; *Form, Fabric, Detail*, MSA Publications, 2014, p.46, p.52

⁷ Iuliano, Marco; Serrazanetti, Francesca; *James Stirling Inspiration and Process in Architecture*, Moleskin SpA, 2015, p.9.

A similar debt to Stirling is revealed in the examination of the staircase conditions. Isolated from their normal architectural context, these take on an independent sculptural character in much the way that Stirling's studies of spatial and circulation sequences do in his designs for The Clore Galley in London, The British Olivetti Headquarters in Milton Keynes or the Staatsgalerie in Stuttgart.⁸

When it comes to details which the visitor might touch (e.g. door handles, joinery work), the sparseness of the drawing and the minimum use of line work, create a more abstract image, where the aesthetic character begins to obscure the familiarity of the element itself. All these studies formed the basis of the resulting published book.

Case Study 2: The Library at the Glasgow School of Art

With the Glasgow School of Art's Library, the task was almost the opposite to that which faced the students examining the Reid Building. The Glasgow School of Art is a building which had been documented and published extensively given its international significance and its acknowledged place in architectural history. The challenge of using the Library as a case study, was how to take a fresh look at such an extensively-documented space, one of the most significant in the last century. The Library had been previously measured in traditional ways with tape measure and pencilled notes by Paul Clarke for a series of exquisite hand-drawings which were published by Phaidon in a book written by James Macaulay⁹. Paul Clarke's own reflections on this process formed one of the invited essays in our own published book documenting the students' work.¹⁰ A key tactical decision that the students made was to conceptually extract the internal timber structure from its stone outer shell, deconstructing it through a series of plans, sections and axonometric drawings, creating a new context from which to view the subsequent drawings.

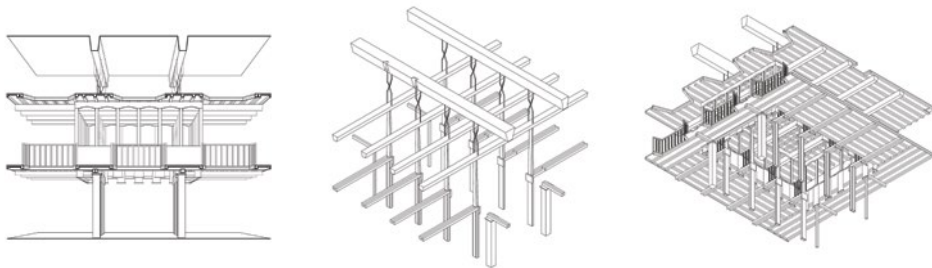

Fig. 08. (Left) Primary Structure, Fig. 09. (Middle) Complexity Through Density, Fig. 10. (Right) Perspective
Source: Baines, Mark, Barr, John, Platt, Christopher; *The Library*, MSA Publications, Glasgow, 2015, p.15, p.18, p.30

⁸ Iuliano, Marco; Serrazanetti, Francesca; *James Stirling Inspiration and Process in Architecture*, Moleskin SpA, 2015, pp 90, 130, 131, 137.

⁹ Macaulay, James; *The Glasgow School of Art*, Phaidon Press, Ltd 1992, 2003.

¹⁰ Clarke, Paul, "The Measure of Things", in *The Library*, Baines, Mark; Barr, John; Platt, Christopher; MSA Publications Glasgow, 2015, pp 48-66.

The students then produced 2D and 3D CAD line drawings which deconstructed what was in effect, the timber 'fit out' construction of the Library structure itself. A series of 3D drawings illustrating primary and secondary structural elements highlighted the way Mackintosh discreetly employed fire-proofed cast iron beams as primary and secondary structural elements as well as the everyday joinery elements which he developed to form gridded patterns and layers. These drawings help us understand the process and composition of the timber assembly as well as clarifying the structural elements from the non-structural elements, an issue which has remained ambiguous until now.

What is revealed by these drawings is the extraordinary debt that the design owes to traditional Japanese architecture and design as well as Mackintosh's own obsession with grids and squares. Despite the total absence of a sophisticated carpentry culture in Scotland at the time, (something which had been elevated to an art form as well as to the status of a protected practice in Japan), the assembly revealed is a composition of many layers of timber sticks, seemingly laid one against the other like some elaborate trellis work. The overall end result belies the crudity and the reality of its many nailed connections. Whilst this debt to Japan had been well documented by previous authors in comparative texts and illustrations, the ability to experience this aspect of the design through a fresh portfolio of drawings is compelling and memorable.

Conclusion

These simple, modest, low tech drawings vividly communicate the anatomy of the architectural idea at the heart of each building. Whilst produced using CAD, they nevertheless display characteristics associated with traditional ink hand draughting techniques from previous generations. The drawings are in some ways operating as transparent filters in letting the fundamentals of Mackintosh's and Holl's design intentions shine through them, revealing each building's architectural DNA. Despite being simple line drawings with a functionalist heritage, we can see now that at some scales, there is nevertheless room for alternative readings and interpretations in a similar way to those usually associated with the expressive tradition of fine art drawings. Despite the application of the 'unambiguous' line, we discover that scale and context play an important role in whether the drawings are easily decoded or whether they are also open to interpretation. Paradoxically, in being both unambiguous and open to interpretation, they are also a reminder that whilst they may not have been produced by the handicraft of a pen or pencil, there is nevertheless an informed human sensibility behind the actions, guiding the choice and character of those lines in an attempt to reveal the hidden secrets of each building. Those secrets, in the form of new knowledge, require the application of a coded medium, such as the hard line drawing, before they will reveal themselves.

Bibliography

- Platt, Christopher; Carter, Brian; Baines, Mark; (Illustrations by kelsy Alexander, Ronan Morris, Micahel Archer), *Form, Fabric, Detail*, MSA Publications, 2014.
- Baines, Mark; Barr, John; Platt, Christopher; (Illustrations by Androulla Hadjichristou, Brigit Luffingham, Joseph Orchard, Jordan Stocks), *The Library*, MSA Publications Glasgow, 2015.
- Scheer, David, Ross; *The Death of Drawing: Architecture in the Age of Simulation*, Routledge. 2014.
- Hambly, M. *Drawing Instruments 1580-1980*, Sotheby's Publications by Philip Wilson Publishers, London 1988.
- Sennett, Richard; *The Craftsman*, Penguin Books, 2008.
- Macaulay, James; *The Glasgow School of Art*, Phaidon Press, Ltd 1992, 2003.
- Iuliano, Marco; Serrazanetti, Francesca; *James Stirling Inspiration and Process in Architecture*, Moleskin SpA, 2015.
- Sternberg R.J., What is the Common Thread of Creativity? *in American Psychologist*, April 2001.
- Baker, N., *Drawing as a Research Process and Drawings as Research Outputs- How Acceptable are they in Various Disciplines?* In, TRACEY Journal: Drawing Research 2012.

Julie Milovanovic ^a, Daniel Siret ^a, Guillaume Moreau ^b, Francis Miguet ^a

^a UMR AAU-CRENAU, Graduate School of Architecture, Nantes, France,

^b UMR AAU-CRENAU, Ecole Centrale, Nantes, France

Enhancing design representational environment to support design learning in the studios

Introduction

Students enrolled in architecture school learn how to design as architects in many ways: by experiencing design in the studios, by working as interns in companies, by visiting landmarks and by discussing architectural values with peers. The design studio stands as the hallmark of architectural programs. The studio culture, derived from the Beaux-Arts ateliers, is based on the apprenticeship model of teaching and learning. In traditional studios, students produce various visual design representations to present their project's state of progress. Plans, sections, diagrams, 3D models, mock-ups and sketches create the external design representational environment of the design critique. During the 'crits', students get a feedback from their instructors, most of the time a practicing architect, who guide them in adjusting and refining their design. Both tutors and learners experience designing actions, while handling representations to reflect and act on the project. Design knowledge is embedded in design representations, and its manipulation set the framework for students to shape that knowledge.

This article will question the potential of an alternative representational environment, set for the crits, to support design pedagogy. We will emphasize the importance of the design representational environment as a major feature of the pedagogic setting in the studio. CORAULIS, an immersive platform, will be built in our university by the end of 2017. The device will provide alternative types of design representations, displaying simultaneously an immersive egocentric view and a dynamic exocentric view of the design within a unique physical space. This equipment will be our test-bed to assess the impact of a change in the design crits representational environment on its pedagogic.

In the first part of the article, we will describe the context of our research as well as our hypothesis. The second part will present devices analogous to CORAULIS, that offer dynamic design representations using Virtual Reality (VR), Augmented Reality (AR) or interactive tables, to support design learning. In the third part, we will question the structure of the design learning process during the crits to define its pedagogic characteristics. Finally, we will argue how our proposed critique setting could benefit the learning outcome in the studio by enhancing the pedagogic features underlined.

Context and framework

CORAULIS, an immersive platform designed by a team of researchers in our laboratory, will shortly be installed at our university. It will support visual and sound immersion with its 360° screen and provide a Spatially Augmented Reality (SAR) table top to augment physical objects (Fig. 01). The size of this high-tech device allows for a table to fit in its center, where users can position their traditional design representations, like mock-ups and 2D printed plans. The 3D model of the same design object will be used to create two virtual views: the top down view, to be mapped onto the mock-up and plan (thanks to SAR techniques) and the first person view, that will be projected on the 360° screen. A user interface is under development to manage interactions (walking, flying) and simulation layer display in both views.

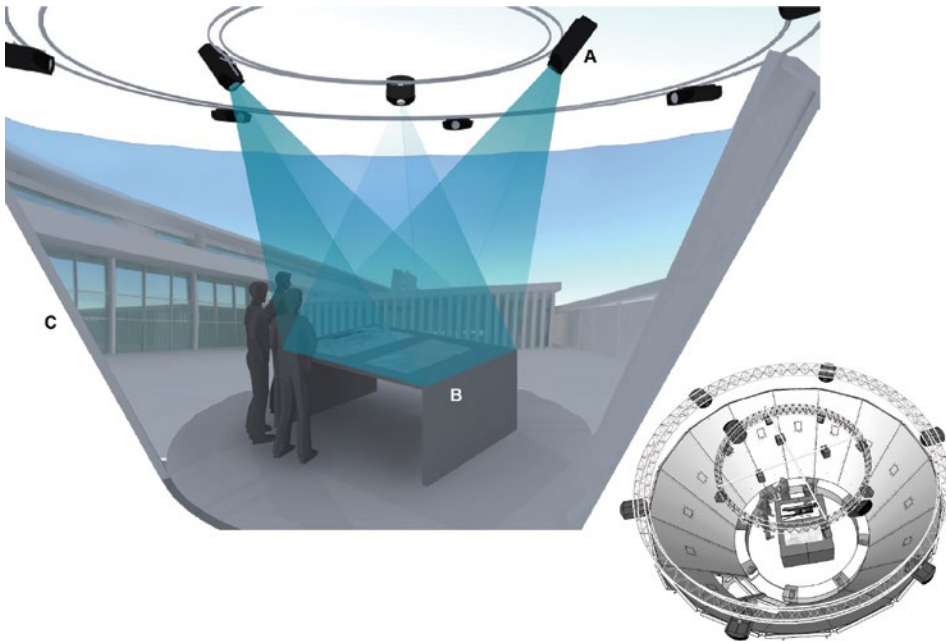

Fig. 01. Possible configuration for CORAULIS (A: 4 beamers for SAR, B: tabletop with augmented plans and mock-up, C: immersive screen)

Source: renderings made by the authors.

Students enhance their skills on spatial representations by handling multiple representations, switching from top-down view, to sections, or to first person sketches. We intend to transfer the traditional desk crit environment of the studio to the CORAULIS environment to test its potential concerning design education. Our hypothesis is that offering a representational environment that supports diverse viewpoints' display, as well as immersive and interactive representations in a unique space, will enhance students' design skills and their learning process. The challenge of the platform's application is to maintain a synchronization between both views. A change in the top down view, as for instance the adjustment of a building envelop, will automatically appear in the first person view representation. The impact of such

an application in CORAULIS can be twofold. On one hand, the upraised perception of the project at a scale 1:1 can augment the design quality of the project, due to the feeling of embodiment and presence offered by VR. And on the other hand, the synchronized 2D/3D environment can assist students to develop their ability to seamlessly switch from one representation to another, and enrich their learning outcome. In the next section we will describe existing devices proposing an alternative type of representational environment to support design education. The potentials and limits of these references gave us insights to develop our own application framework.

Use of VR, AR and hybrid platforms to support design education

Extended research was conducted in order to develop tools providing alternative types of design representations, using Virtual Reality (VR) and Augmented Reality (AR) techniques. The two essential characteristics of VR are immersion and interaction¹. The user can navigate an artificial environment, that provides a sensitive experience. On the other hand, AR offers a superposition of virtual information in the real environment, that are displayed either with a HMD (Head Mounted Display), a smart tablet or physical surfaces (SAR)^{2,3}. Depending on the display setting, these devices propose different uses and aim to support various activities of the design process. We identified six display configurations (HMD VR, Immersive screen VR, HMD AR, Screen based AR, indoor SAR and augmented table top) that we will exemplify to highlight their potential.

The CAP VR environment, an example of HMD VR, was employed for an architectural design studio, by second year students at Ball State University⁴. Students used the HMD to visualize their design during studio sessions. This immersive representational environment upraised students' spatial perception of their design. The analysis of students' design quality showed the positive impact it had on students' design outcome, underlining the educational potential of such a device. Nevertheless, the limit of this tool is that it prevents natural communication between students and tutors, since the student is wearing the HMD. Immersive screen VR is an alternative to the HMD VR. The Hyve-3D proposes an immersive sketching environment, set in a half-hemispherical screen, for students to develop their creativity and experience co-design⁵. Several collaborative design studios, between students based in Montreal, and in France or in the USA, were organized with critiques lead in the platforms set in each university. Users seamlessly interact with their designs, and can perform collaborative

¹ Fuchs Philippe; Moreau Guillaume; Guitton Pascal, eds. *Virtual Reality: Concepts and Technologies*. London, UK: CRC Press, Taylor & Francis. 2011.

² Azuma Ronald. "A Survey of Augmented Reality," *Presence: Teleoperators and Virtual Environments* 6. no. 5. 1997. p.355-85.

³ Raskar Ramesh; Welch Greg; Fuchs Henry. "Spatially Augmented Reality," in *First IEEE Workshop on Augmented Reality (IWAR'98)*. 1998. p.11-20.

⁴ Angulo Antonieta. "Rediscovering Virtual Reality in the Education of Architectural Design: The Immersive Simulation of Spatial Experiences," *Ambiances. Environnement Sensible, Architecture et Espace Urbain*. 2015.

⁵ Dorta Tomás; Kinayoglu Gökçe; Boudhraâ Sana. "A New Representational Ecosystem for Design Teaching in the Studio," *Design Studies*. no. 47. p.164-86.

immersive sketching thanks to a 3D cursor interface. Protocol studies, combined with the monitoring of users' design flow, supported that the platform enhances design creativity. Another example of immersive VR is the Immersive Visualization Theatre (IVT), a large screen with stereoscopic visualization, that hosted design critiques as a part of a case study at Technion University⁶. The aim was to compare the type of knowledge construction actions during critique sessions in the IVT and traditional desk crits. The study showed that deeper learning loops were more present in the IVT crits, so it could benefit students' knowledge construction. For both types of VR display, the main feature is the scale 1:1 visualization of the project, that upgrades the design evaluation process as well as the design quality outcome. The limit is that the representational environment is only set in the virtual world, putting aside tangible representations.

The use of AR to accompany design process and education is praised to augment collaboration and communication, merging virtual and physical information. Experimentations with BenchWork showed the potential of the integration of CAD, AR and simulations for design collaboration and desk critiques⁷. Users, wearing a HMD, can interact with the same virtual model with the help of a toolbox, and create new objects or modify existing ones. Screen-based AR became easily accessible with the commercialization of smart tablets. A recent study formalized impacts of the use of SDAR (Smart Device AR) on design communication during a collaborative design activity⁸. Students, teamed by pair, relied on the physical model to work on an urban project. Half of them also used the SDAR application. The analysis of the design conversations showed different behaviours depending on the setting. This study pointed out that with SDAR, the time span of the designing and revising design was longer than in a traditional setting, showing the efficiency of that tool for a design session. At a smaller design scale, the SARDE (Spatially Augmented Reality Design Environment) application provided a suitable setting for an interior design session⁹. The authors emphasize the difficulty for students to represent their design in diverse format (2D and 3D) and to acknowledge design issues. The study couldn't show the impact on the learning outcome, but students expressed the positive experience they had using the device for an on-site, scale 1:1 refinement of their project. For HMD AR and SDAR, collaboration and interaction with the virtual model through tangible objects is put forward, while on site scale 1:1 design and evaluation is the main quality of SAR applications.

⁶ Soffer Hadas. "Immersive Virtual Environment Technology: A New Crit Learning Model," in *Proceedings of Places for Learning Experiences: Think, Make, Change Symposium*. Thessaloniki, Grèce. 2015. p.236-246.

⁷ Seichter Hartmut. "Benchwork: Augmented Reality Urban Design," in *Proceedings of the 9th International Conference on Computer Aided Architectural Design Research in Asia*. Seoul, Korea. 2004. p.937-46.

⁸ Gül Figen L; Halici Müge S. "Collaborative Design with Mobile Augmented Reality," in *Proceedings of the 34th eCAADe Conference*. Oulu, Finland, 2016. p.493-500.

⁹ Chen Chien-Tung; Chang Teng-Wen. "1: 1 Spatially Augmented Reality Design Environment," in *Innovations in Design & Decision Support Systems in Architecture and Urban Planning*. Springer. 2006. p.487-99.

Augmented tabletops provide a suitable environment for collaborative design and decision making. Simulations, like shadows, wind flow or agents are easy to grasp while displayed on the interactive table. The Luminous Planning Table was used for design studios at MIT to support students designs and learning process¹⁰. Most students asserted a positive feedback on the use of the device for their project. Representing urban simulations, while using an accessible tangible interface, improved the integration of those factors in their design process. The Collaborative Design Platform is also worth mentioning¹¹. It offers a similar design environment composed of an interactive table top and a vertical screen for first person view. Urban designers, when they display foam mock-ups on the table, can see how it affects wind flow or shadow cast on the whole urban site. The same 3D scene is displayed on a vertical screen, providing an egocentric representation of the urban proposition.

Those examples draw the outlines of our research references' context. The advantages brought by those devices are either the embodiment of the user in the virtual environment, projects' representation at a scale 1:1, design collaboration or the contribution to the design quality supported by the display of interactive simulations. The potential of those devices for design pedagogy unveils but is not yet clear. It seems necessary to question the structure of the design learning process, in order to develop a suitable representational environment framework that can support design pedagogy in the studio. In the following section, we will highlight specific features of design learning in the studio.

Learning how to design in the studios

The design studio is the cornerstone of architectural degree programs. Students and tutors meet once to twice a week, in the studio for a design critique session. Each student presents his/her work in progress, which is followed by a discussion on the design quality. During that moment, design propositions are evaluated, issues are discussed and potential solutions are formulated. Students develop design skills in a process of trial and error, by practicing design. Instructors act as a source of design expertise and guide students in their designing process. The studio setting benefits the social constructivist approach of learning and can be mapped onto the "community of practice" concept^{12,13}.

Schön¹⁴ considered design studio as an educational model to support the

¹⁰ Underkoffler John; Ishii Hiroshi. "Urp: A Luminous-Tangible Workbench for Urban Planning and Design," in *Proceedings of the SIGCHI Conference on Human Factors in Computing Systems*. ACM. 1999. p.386-93.

¹¹ Schubert Gerhard et al., "Bridging the Gap: A (Collaborative) Design Platform for Early Design Stages," in *Proceedings of the 29th eCAADe Conference*. Ljubljana, Slovenia. 2011. p.187-193.

¹² Vygotsky Lev. *Mind in Society: The Development of Higher Psychological Processes*. Cambridge Massachusetts. Harvard University Press. 1978.

¹³ Lave Jean. "Teaching, as Learning, in Practice.," *Mind, Culture, and Activity* 3(3). 1996. p.149-64.

¹⁴ Schön Donald. *The Design Studio*. London. RIBA. 1985; Donald Schön, "The Architectural Studio as an Exemplar of Education for Reflection-in-Action," *Journal of Architectural Education*. 1988.

development of tacit knowledge or reflection-in-action, that are specific to professional knowledge. Constructed design critiques are essential to provide an efficient learning setting¹⁵. Design knowledge are shared during the critique, between the instructor and the students. Tutors have a knowledge-in-action about design, which means that they know how to design in practice. Most of the time, they highly struggle to describe how they design, because they are not fully aware of the design processes they exploit. Indeed, Curry¹⁶ underlines that depending on the level of expertise designers have, they call different types of knowledge to solve design issues. While experts rely on procedural and strategic knowledge (knowledge-in-action), novices and advanced beginners (students) depend on their factual, conceptual and a few procedural knowledge. Experts developed their design knowledge through years of practice, where they assimilated design strategies, or what Schön's refers to as "design repertoires"¹⁵. During the critique, instructors challenge students' designs, and if design issues are pointed out, get involved in design demonstration or a collaborative design activity with the student. This mode of teaching is necessary since the learning objective is design itself which cannot be only described as factual knowledge and procedural activities. Students learn during the critique, either by observing their tutor performing a design activity or by engaging in a co-design activity.

Design conversations between students and tutors, that follows students' presentation of their project, is an important moment of the crit session. Fertile and constructive communication between the learner and the tutor will support a suitable learning framework. Nonetheless, the asymmetry of design knowledge between the expert (tutor) and the novice (student) can hinder mutual understanding on design issues. As explained before, experts possess procedural and strategic design knowledge that they seamlessly recall to solve design issues. Students will need some years of practice to acquire that type of knowledge. This asymmetry of knowledge favors a student/instructor relationship based on the dependency of the student upon his/her instructor. Oschner¹⁷ underlined the vulnerability of students during the studios and the importance of maintaining a constructive bond in the student/instructor relationship.

The design discussion during the critique is set in the representational environment. Visual design representations form a communication space for the participants to express and share their mental models of the architectural project, and engage in designing¹⁸. Goel¹⁹ proposed a model to link design phases, design representations and their transformations' types: lateral transformation, a change in the concept and vertical transformation, a detailing of a concept. For Schön¹⁵ and Goldschmidt²⁰

¹⁵ Dinham Sarah M. "Teaching as Design: Theory, Research and Implications for Design Teaching," *Design Studies* 10, no. 2. 1989. p.80-88.

¹⁶ Curry Terrence. "A Theoretical Basis for Recommending the Use of Design Methodologies as Teaching Strategies in the Design Studio," *Design Studies* 35, no. 6. p.632-46.

¹⁷ Oschner Jeffrey K. "Behind the Mask: A Psychoanalytic Perspective on Interaction in the Design Studio," *Journal of Architectural Education* 53, no. 4. 2000. p.194-206.

¹⁸ Goldschmidt Gabriela. "The Black-Curtained Studio: Eulogy to a Dead Pencil," in *SCAD Symposium Proceedings*. Bremen. 2011.

¹⁹ Goel Vinod. *Sketches of Thought*, MIT Press, 1995.

²⁰ Goldschmidt Gabriela. "On Visual Design Thinking: The Vis Kids of Architecture," *Design Studies* 15, no. 2. 1994. p.158-74.

design representations influence the direction taken during design activities. Oxman²¹, on the other hand, argued how re-representing designs can be a key element of design education. Design activities imply a modification of the design representations which give a feedback to the designer on its own design. Design knowledge is embedded in external design representations which supports that they act as a major factor in the pedagogic setting of the critique. While discussing design issues, representations' manipulation situates design activities in a specific representational environment.

Based on literature references, we pointed out pedagogic characteristics of design critiques in the studios: 1) Design learning is based on an observation of a design activity or collaborative designing during the crit; 2) The asymmetry of design knowledge between tutors and students accentuates the importance of tutor/student relationship; 3) Design knowledge is embedded in the design representational environment.

Supporting design learning by offering a suitable critique setting

The design representational environment set the space for discussing design issues and constructing design knowledge during critique sessions in the studios. VR and AR techniques offer alternative types of representations that are immersive, interactive and promote users' collaboration. CORAULIS, merging both technologies, sets a crit space that will address the pedagogic characteristics underlined above. First of all, it will offer an intelligible design representational environment to favor communication and collaboration between instructors and students. The display of simulations can accelerate the evaluation process and lead to fertile discussion on design issues. That upgrade of the representational environment lays the space for knowledge sharing and co-construction. While co-designing, students experience a higher level of active participation, constructing their designing skills in a sustainable way. Moreover, the sense of presence provided by immersive representations can support a better understanding of the design being reviewed. The display of multiple and synchronized views on the architectural project can entail a better understanding of both student and tutors' mental model of the project to avoid misunderstanding on the design's concepts. Finally, students can upgrade their skills to switch from diverse representations format, within the same representational environment. The features proposed in our framework will impact students' way of constructing their knowledge and can be beneficial for their learning outcome.

Our future work will consist of running an experiment to verify our hypothesis. We intend to compare critiques' design learning potential in a traditional setting and in the CORAULIS setting. Our evaluation will be based on the critique conversation analysis, using the protocol analysis method²². Commonly, this method is exploited to study designers' behaviour, so it will be adapted to analyze design learners' behaviour. The method aims to assess the type of design actions happening during

²¹ Oxman Rivka. "Educating the Designerly Thinker," *Design Studies* 20, no. 2. 1999. p.105-22.

²² Ericsson Anders; Simon Herbert. *Protocol Analysis: Verbal Reports as Data*. MIT Press. 1984.; Gero John; Mc Neill Thomas. "An Approach to the Analysis of Design Protocols," *Design Studies* 19, no. 1. 1998. p.21-61.

the crit, students' engagement in these design or co-design activities and the way they manipulate design knowledge embedded in the representational environment. The information deduced by our critique conversation analysis method will give us insights on the students' behaviour during the critique as well as an indication of its pedagogic quality. A short interview with both tutor and student, after the crit session, will complement that first approach, and include learners' and tutors' perceptions in the overall analysis. The stake of our work is to test the performance of a device like CORAULIS in a pedagogic situation, considering a single crit session as a unit of analysis. Our approach can provide foundations for future interventions in the studio pedagogy to improve student learning.

Study of psychological evaluation and its relation to intervals “MAAI” in the external spatial composition of architecture.

Introduction

In the temple space represented by Horyu-ji Temple, The “between” and “intervals” created by multiple architectures constitute an important impact. This “between” and the “intervals” are called “MA” or “MAAI” in Japan. MA is not just the absence of spatial elements. MA is not just an ‘absence’ of spatial elements but a ‘creative’ interval, which is carefully controlled and designed. This concept of MA is also common in the practice of Japanese drawing and calligraphy, where it is considered the artist's own individual space. MA and MAAI is used as a concept to define both time and space in Japan.

‘In Japanese the concepts of space and time have been simultaneously expressed by the word MA. MA defined by Iwanami Dictionary of Ancient Terms as “the natural distance between two or more things existing in a continuity” or the space delimited by posts and screens (rooms)” or “the natural pause or interval between two or more phenomena occurring continuously, “gives use to both spatial and temporal formulations. Thus the word MA does not describe the West’s recognition of time and space as different serializations rather, in Japan, both time and space have been measured in terms of intervals. Today’s usage of the word MA extends to almost all aspects of Japanese life-for MA is recognized as their foundation. Therefore architecture, fine arts, music and drama are all known as “the art of MA”’¹

In architectural space, especially when there are multiple buildings, there is always this MA and MAAI between buildings. It is extremely important to focus on this interval for building placement planning and building proportion decisions when planning the placement and deciding the external proportion of the buildings. Since ancient times, the buildings in the major temples have been planned very carefully,

¹ citations: Catalogue of Isozaki Arata’s 1976 exhibition, “*Ma: Space/Time in Japan* Cooper-Hewitt Museum, New York. Where Ma is the Japanese spatial-temporal concept which suggests a gap, opening, delay or silence. It can be understood as an indivisible state of time and space. ‘Ma’ is ‘the natural distance between two things existing in a continuity, and literally means ‘standing in-between’.

considering how this ‘interval’ would be felt, recognized, and memorized. And also, the architects in our age always contemplate the same matter. Therefore, it’s important to catch how people recognize the MA, whether it’s grasped and whether its system and the relationship clear in Architecture and Urban planning. We think this material can be useful research for the design. In this research, we aim to objectively clarify these relationships from the viewpoint of psychological evaluation and spatial composition.

What is the MA and MAAI

The concept of MA is complex, and has a lot of cultural depth beyond the literal translation of ‘space’ and ‘place’. It implies not only a place, but also the recognition of the space in between. The Realm of Art. ‘*Ma ga warui*’ or its opposite, ‘*ma ga umai*’, is often used as an aesthetic judgment of Japanese calligraphy or sumi-e painting. Compared with Western painting, these Japanese art forms involve large unpainted areas. Those unpainted areas is MA. This balance of form and space will always be taken into account in the final artistic judgment. (Fig.01)

The MAAI is also used in Japanese martial arts such as kendo. It is a complex concept, incorporating not just the distance between opponents, but also the time it will take to cross the distance, angle and rhythm of attack.

MA was adopted by Japanese Buddhists to represent the concept of emptiness or the void, some thing which is demonstrated in many of their works. This concept is not something generated by rational thought, but an expression of an indescribable and solely individual experience accessible to someone during meditation. The spirit of Zen. One of the most famous examples, is the rock-garden at Ryoanji, the “Peaceful Dragon Temple” in Kyoto. We do not know who created the garden, nor when it was created in its present form. It is a karesansui (dry landscape garden), to be appreciated from a fixed vantage point, on the verandah of the temple.² (Fig.02)



Fig. 01. MAAI in Japanese art, Ikebana and Callygraphy.

Source: *Drawing-Flower arrangement in living* by Ikenobo Senei. *Calligraphy-Drawing* by Ikkyū Sōjun Zen priest, *Books from Theories of Japanese Design* by Teiji Ito.

² Gunter Nitschke. *KYOTO JOURNAL* 8, Based on a talk given at Cornell University in June 1976 at the Top Seminar on Time and Space in Japanese Culture, sponsored by the Joint Comm Japanese Studies.



Fig. 02. Ryoanji Temple Photograph and Sketch to interpret the MAAI.

Source: Photograph-Kyoto Photo, photo53.com Sketch-by author.

Summary/Conclusion

Selection and overview of research subjects

As with the external space of the architecture like Horyu-ji Temple with its unique MAAI in Japan, we chose survey subjects mainly representing temple building from the late 7th century to the present day. In this study, 13 sites in total were surveyed: 3 sites from Nara Prefecture, 4 sites from Kyoto Prefecture, 2 sites in Kanagawa Prefecture and 2 sites in Gunma Prefecture, totaling 13 sites. (Table 01)

Grouping of “MAAI” space

Group (a) and group (b) differ in impression. “MAAI (a)”, felt while standing between building, and building and “MAAI (b)”, felt when looking at the building group from outside. We divided these two groups and analyzed them.(Fig. 03)

Horyuji Temple(a)	Sennyuuj Temple Butsuden→Shariden(b)	Daimon→Butsuden(b)	Ginkakuji Temple Approach(a)	Ginkakuji→Hondo(a)
Kentyouji Temple Sanmon→ Butsuden(b)	Butsuden→Hatto(b)	Toshodaiji Temple Nandaimon→Kondo(b)	Kondo→Koudo(b)	<p>group(a)→Viewpoint(a) group(b)→Viewpoint(b)</p>
Houkouji Temple Hondou→Kaido(a)	Hondou→House(b)	Enkakuj Temple Sandou→ Butsuden(b)	Karamon→Houjyo(a)	

Fig. 03. Surveyed List / Grouping of MAAI.

Psychological evaluation analysis

A psychological evaluation was conducted by several examinees in the field. They obtained data on the influence that the difference of the external space composed of the arrangement of the building group, the outer wall of the building, the form of the eaves etc. has on the person. The subjects were selected and implemented mainly from students of the architecture department, in order to accurately capture the atmosphere and the like of the space.

The semantic differential method was used to obtain psychological evaluations about the impression of each object. The evaluation scale was extracted based on past research. When the field survey was conducted, several subjects were informed of the target site from the outside of the Group (a) building group, while the Group (b) standing between architecture and building 30 stages on the relationship between 30 adjective pairs and buildings I got it filled out in the evaluation. The results of the experiments were tabulated for each adjective versus the evaluation scale, and the average (psychological) (Figure 1) was calculated.

On the whole, a high psychological evaluation was obtained for <Linear feeling>, <Flat ground feeling>, <Dignified feeling>. “Distance between two buildings” of Group (b) is small (less than 25 m) “Sennyuuj Temple” “Kenchoji Temple” “Toshodaiji Temple” <Heavy Feeling>, <View closed feeling>, <Dignified feeling>, etc. A high psychological evaluation was obtained. Since the distance between the two buildings is small and the entire building cannot be seen, there is a tendency to get the impression that the building is large and dignified. “Sennyuuj Temple” gave a high psychological evaluation for <Simple feeling> <Depth feeling> <Induction feeling>. It seems that the trees with the height on the side highlighted the length of the distance between the two buildings and got the depth. (Fig.04)

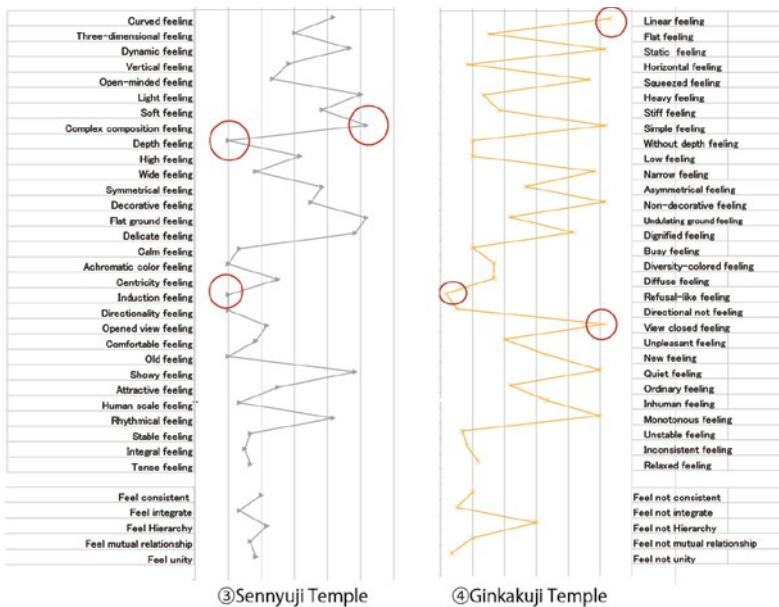

Fig. 04. Psychological evaluation analysis chart.

Conclusion of Psychological evaluation analysis

From the above, it was possible to obtain the psychological evaluation of “Maai” by the semantic differential method of 13 target building groups. Specifically, it was found that a high evaluation was obtained for <Linear feeling> <Topographically flat feeling> <Dignified feeling>.

The distance between the two buildings in Group (b) is short (25 m or less), Sennyuji Temple, Kenchoji Temple, Toshodaiji Temple is <Heavy feeling> <View closed feeling > <Dignified feeling> It was highly appreciated. Because the distance between the buildings is so close that the entire building can't be seen, it tends to have a big impression of things stately feeling.

Purpose and method of research of psychological evaluation and spatial composition.

And next, we performed correlation analysis to grasp the relationship between “psychological evaluation” and “physical quantity” for the subject concerning the 13 intervals. “DW / H (Distance between two buildings (DW, DR 1, DR 2, DC)” DW / H (distance between two buildings / average height)Correlation analysis was carried out using “physical quantity” of height of the eaves (RD) height ratio (lower side is assumed to be 1).

In this research, we aimed to objectively clarify these relationships from the viewpoint of psychological evaluation and spatial composition.

Physical quantity setting

[Distance between two buildings] is the distance between the center of the building and the center (DC), the distance between the eaves and the eaves (DR), and the distance between the wall and the wall (DW). The eaves' length (RD) is the difference between DW and DR. (Fig.05)

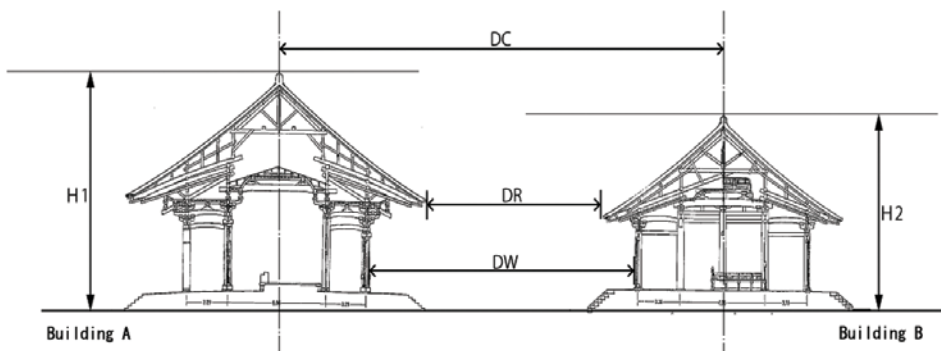

Fig. 05. Image caption here [Physical quantity setting].

Correlation analysis

[Distance between two buildings (DW)] and <Wide feeling / Narrow feeling> correlation coefficient was found to be 0.593. Among them, “Horyuji Temple” is close in distance, but the evaluation gathered on <Wide feeling>. This is thought to have been widely because there was a margin around the building and the fact that Kondo

and the five – storied pagle existed in parallel in the wide space surrounded by the corridor. (Fig.06)

[Distance between two buildings (DW)] and <Opened view feeling/View closed feeling>, however, a correlation coefficient of 0.573 was observed. When the distance between two buildings (DW)> 40 m or more, the psychological evaluation was almost constant between 2 and 4. From this, it can be predicted that the evaluation of the subject’s < Opened view feeling > is not changed for more than 40 m and becomes constant. (Fig.07)

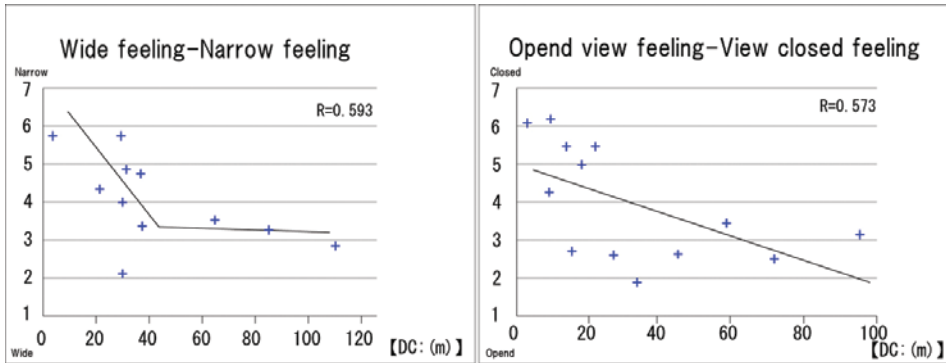

Fig. 06 & Fig. 07. Image caption here [Correlation analysis diagram].

Conclusion of psychological evaluation and spatial composition.

In the correlation analysis with “relationships between buildings”, evaluations were high in all places, <Unity feeling> And <Integrate feeling>. Even if the buildings constituting it are asymmetric, it is felt that the sense of distance between the buildings and the volume balance on the visual sense etc. are equal in the space where appropriate intermezzes were made, and <Unity feeling > And <Integrate feeling > can be felt. In correlation analysis with “distance” between two buildings, we showed a correlation with [openness] factors such as <Wide feeling / Narrow feeling> and <Open feeling / Closed feeling>, [vertical There was also a correlation with <Vertical feeling / Horizontal feeling> and < Induction feeling / Refusal-like feeling >. This is thought to be due to the fact that the distance is increased and the levelness of the eaves, the roof, etc. is more recognized than the vertical feature such as the columnar column. In the correlation analysis between the distance and the height (DW / H), it shows the correlation between < Depth feeling/ Depth without feeling>, the greater the DW / H becomes, the smaller the feeling of depth becomes. It is shown that the undulation of the topography cannot be felt. For traditional buildings with diverse forms it is difficult to simply explain ‘distance’ between distance between two buildings and D / H.

Conclusion

As a result of the above, the creative intervals of “MAAI” made up by the building group were clarified to some extent by psychological evaluation and physical quantity. Even if the buildings constituting a space are asymmetric in the space where appropriate intervals are planned, it is felt that creative intervals of “MAAI” due to the sense of distance between the buildings and the visual volume balance the buildings. Even if the buildings constituting it are asymmetric, it is felt that “the balance is balanced” due to the sense of distance between the buildings and the visual volume balance etc, and bring a feeling of “unity feeling” and “integrate feeling” is inferred. We will further increase the target districts in the future and examine the mutual relationship concretely. In order to improve the accuracy of the analysis result.

Bibliography

Books:

- Arata, Isozaki. *“Japanese-style thing” in the building*. Tokyo: Shinchosha. 2003.
- Yuichiro, Koujiro. *MA/Design of Japanese Architecture*. Tokyo: Kajima Publication society. 1999.
- Teiji, Yosimura. *Japanese space structure*. Tokyo: Kajima Publication society. 1982.
- Teiji, Ito. *Japanese Design Theory*. Tokyo: Kajima Publication society. 1966.
- Tadahiko, Higuchi. *Structure of landscape*. Tokyo: Gimodo Publication. 1975.
- Lynch, K., *“The Image of City”*, M.I.T.Press, 1960, /Kenzo Tange, Translated by Reiko Tomita, Tokyo: Iwanami Shoten, 1968.

Publications and documents without author:

- Important cultural property 12 Building* . Tokyo: Mainichi Shimbunsha. 1973.
- Important cultural property 15 Building* . Tokyo: Mainichi Shimbunsha. 1973.

Website:

- <http://www.kyotojournal.org/the-journal/culture-arts/ma-place-space-void/>
(accessed 03.05.2016)

Blurring the Boundaries: Visual Design Language, Product Design, and Fabrication in an Architecture Course

Introduction

Visual language is the basis of all design which includes architecture. Setting aside the functional aspect of architectural design, there are principles, rules, and concepts in respect to visual organization that helps a designer accomplish a task successfully. This is the beginning of design learning which needs to be instilled in a designer before dealing with any functional design. Primarily, this visual language is more of a process of systematic thinking and less of emotional and intuitional outcome. Good design is always about executing these principles in precise and concrete terms with maximum objectivity and minimum ambiguity.

It is noticeable that the current trends of design education at various institutions are leaning towards the creation of forms that are dependent on ability of digital application rather than incorporation of principles of design, associated visual grammar, and aspects of other design forces such as program, site, environment, etc. Students seem to gravitate to pattern-making and complex form-making that are generated through digital applications. Such applications lack both detailing of reality, understanding of visual grammar, and iteration of 3-d composition.

With the availability of digital software and hardware, in particular 3D applications in combination with laser cutters, 3D printers, and CNC routers, unlimited opportunities are available to explore design principles that encompass architecture, product design, and fine arts.

The primary objective of this paper is to demonstrate the possibility of teaching design principles through a series of artifacts. These artifacts have strong graphic application as well as use of digital technology for fabrication.

In the curriculum of every design school, regardless of the fields of specialization, there is always a course variously called Basic Design, Fundamental Design, Two-Dimensional Design, etc., which deals with the grammar of this visual language. For architectural education it is often very difficult to teach such visual languages in studios where program, client, analysis, etc. takes priority over other factors. An elective course with the shift in integration of fine arts, visual graphics and digital technology can become a good complementary course and be a relief for students to strengthen the sense and skill of arts and crafts and visual design vocabulary.

Current Dynamics of Architectural Education

For many decades, particularly until the early part of last century, the design studio pedagogy in architecture continued to be an unquestionable and untouchable area. It was primarily a by-product of professional practice.

Around the late 1970s, that scenario started to change gradually. Several architectural scholars started to discuss design education more along the line of an exploratory and theoretical thread. Since then, studio teaching started to emerge into more systematic and research based learning with more emphasis on observation and analysis.

Formal architectural education was established at the turn of the seventeenth century by the “Beaux-Arts” in France. It emerged in response to the value system at that time and continued to be the only model for two hundred years.

Towards the end of the nineteenth century, the value system started to change. A new development of formal design education strongly appeared before World War-I in Germany. The Bauhaus model of design education emerged in response to the technological development and industrial revolution. The word “Bauhaus” itself means “house of construction” or “school of building”. In spite of its name, and the fact that its founder, “Walter Gropius” was an architect, the Bauhaus during the first years of its existence did not have an architecture department. Nonetheless, it was founded with the idea of creating a “total” work of art in which all arts, including architecture, would eventually be brought together. The Bauhaus style later became one of the most influential currents in modern design and architectural education.

With current dynamic changes in the learning system, learning process, social values, and evolving digital means, the design studio pedagogy is now more susceptible to questions and reformation more than ever. In the late 1980s, 1990s, and early 2000s, a few attempts were made by individual scholars to investigate and critically question the trend of design pedagogy. Design juries on Trial: The Renaissance of the Design Studio (Kathryn Anthony, 1991), Voices in Architectural Education (Thomas A Dutton, ed., 1991), Architectural Education: Issues in Education Policies and Practices (Necdel Teymur, 1993), Building Community: A New future for Architectural Educational and Practice (Ernest L. Boyer and Lee D. Mitgang, 1996), Changing Architectural Education: Towards a New Professionalism (David Nicol and Simon Pilling) are important publications on architectural education which critically examine current trends and needs of changes.

Blurring Role of Design and Communication Process

Although significant changes had happened in all aspects of life in the last three decades including architecture and urbanization, the current trends and approaches of teaching design continue to follow principles and practices developed in the past influenced by the Bauhaus. From the academic perspective, Bauhaus principles still seem to be relevant because architecture is always seen as a fine art where principles of formal composition are considered being of greatest importance.

In institutional education, the design studio still is the primary focus where various other courses complement and enrich the needed learning for studio support.

History/theory, Construction Technology, Environmental Technology, Structure, Graphic Communication and Professional Ethics are the main divisions of courses which typically support studios (refer to diagram).

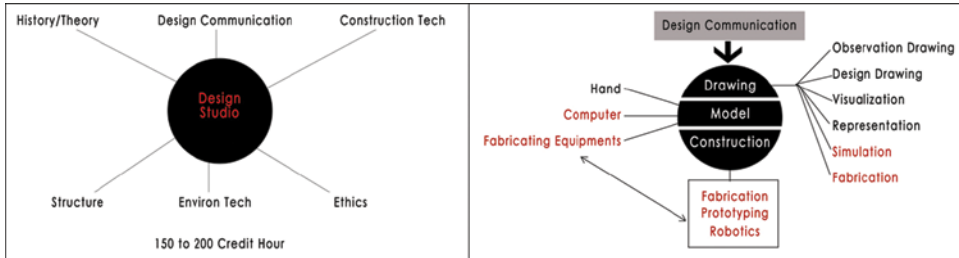

Fig. 01. (a) Relationship between studio and support courses. (b) Various components of design communication

Apart from criticism of studio teaching, another change in the overall architectural education that already took place is in the area of design (graphic) communication teaching. After more than two decade’s argument, it is now clear that the role of hand drawing and its implication in design visualization is progressively diminishing in the formal curriculum. On the other hand, a noticeable emergence of courses in areas of sustainable environment has become necessary in many curriculums.

Concurrently, the new generations of educators see courses in graphics as an opportunity to introduce various digital tools such as fabrication, analysis, simulation, etc. to replace manual graphics and tactile design thinking. It is not rare to see even the integration of robotics in beginning studios. Often the research conducted in doctoral works by many young educators seem to be reflected in their beginning studio teaching without much reference to overall learning goals.

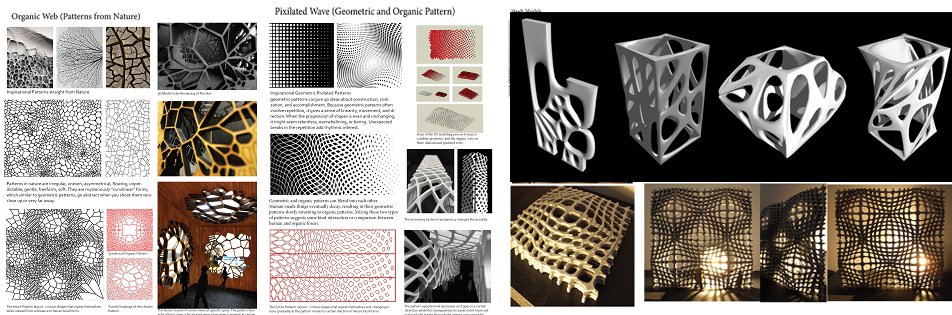

Fig. 02. New trends of graphics teaching with laser cutter, CNC router, and 3D printer

In addition, from students’ perspective there is a great interest in courses that offer integration of technology and exploration of new media which can minimize manual process and offer design options generated through software-hardware than creation by human mind. Students tend to gravitate to courses that are offered by new generation educators that often can be perceived as a self-standing course without much integration with the overall curriculum of the program.

The clarity of how to teach and what to teach is becoming blurrier in respect to design principles. In architecture, we cannot teach design, but can teach its principles. The recent trend seems to be parting from this notion and striving for tool-dependent learning. Design thinking in some instances is left to digital software parameters and processes of fabrication.

Visual Design and Architectural Design

Design is a process of purposeful visual creation. Unlike painting and sculpture which are the realization of artists' personal visions and dreams, design fulfills practical needs. A good design, in short, is the best possible visual expression of the essence of a message or a product. This creation should not only be just aesthetic, but also functional, while reflecting the taste of the time.

Design is practical. The designer is a practical human being. But before he/she is ready to tackle practical problems, he/she has to master a visual language.

Although a designer can work without conscious knowledge of any of these principles, rules, or concepts, because his personal taste and sensitivity to visual relationships are much more important, a thorough understanding of them would definitely enhance his/her capability in visual organization.

In the first year's curriculum of every design school, regardless of the fields of specialization, there is always a course variously called Basic Design, Fundamental Design, Two- Dimensional Design, etc., which deals with the grammar of this visual language.

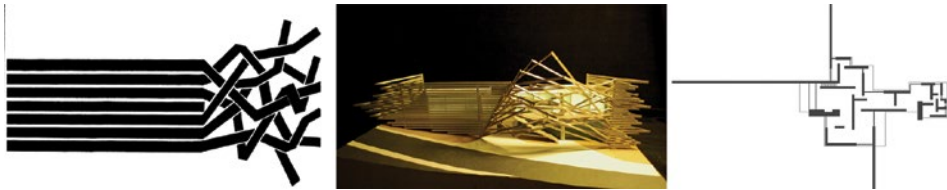

Fig. 03. Composition of lines, a visual grammar in art architecture, and tectonics

Interpreting the Visual Language

There are numerous ways of interpreting the visual language. Unlike the spoken or written language where the grammatical laws are more or less established, the visual language has no obvious laws. Each design theorist may have a completely different set of discoveries. Primarily, this is more linked with systematic thinking and very little to do with emotion and intuition. This is to tackle the principles in precise and concrete terms with maximum objectivity and minimum ambiguity.

Elements of Design

The elements are, in fact, very much related to each other and cannot be easily separated in our general visual experience. Tackled individually, they may appear rather abstract, but together they determine the ultimate appearance and contents of a design.

Four groups of elements are distinguishable:

- a. conceptual elements
- b. visual elements
- c. relational elements
- d. practical elements

The ordering principles of design include: concepts of Axis, Symmetry, Hierarchy, Datum, Rhythm, Repetition, Transformation, Gradation, Radiation, Anomaly, Contrast, Concentration, Positive-Negative, Texture, etc.

The most important visual element after synthesis of various forces is ‘form’. Three-dimensional forms can encounter one another in numerous ways, such as being Detached, Touched, Overlapped, Penetrated, Subtracted, Unified, Intersected, Coincided, etc. The various kinds of interrelationships should always be explored when forms are organized in an architectural design in order to achieve a meaningful space composition.

Design Formulation: Form Strategy

An act of design has various tangents, including site, climate, client, and program that culminate finally into a three-dimensional spatial built form composition. Assuming that after considering all factors a student has formulated the relationship of spaces and its volume and is ready to explore the final form. At that point the form may be generated from three distinct methods.

- Through known geometric parameters
- Through discovery of unknown form manipulation in physical models
- Through computer application

Through known geometric parameters

The traditional form-making strategy is fully dependent on known geometry, be in 2D or in 3D. In this method, syntheses of all design considerations are spatially composed in a known geometry and their transformative forms. This is still a valid design method where use of visual composition and language of point-line-plane and solid-void in 3D form can create a spatial composition that is contextual and generated from the program, site, and environment. Examples provided are manipulation of a known geometry, a square in plan and a cubic form in three-dimension.

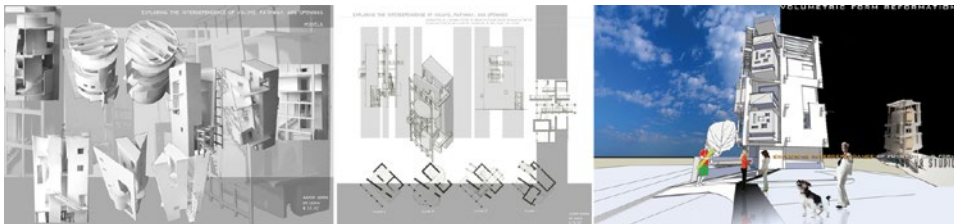

Fig. 04. Architectural design process initiated through known geometric manipulation

Through discovery of unknown form manipulation in physical models

The second method has a strong component of discovery through making. An example shown below would be to focus on the strength of a single generative method in design; that is, rules and strategies in forming spaces and forms using the notion of ‘Fold.’ Such an exploration allows for the emphasis on the reiterative and cyclic character of a design process, in which a step is constantly revisited in order to proceed to the next iteration. In this format, folding is articulated as a starting point in the exploration of the morphology. The process of the morphology include:

- Starting point not from known parameters
- Unexpectedness
- Discovery
- Mapping the process
- Establishing the grammar
- Extending to characterize space-qualities

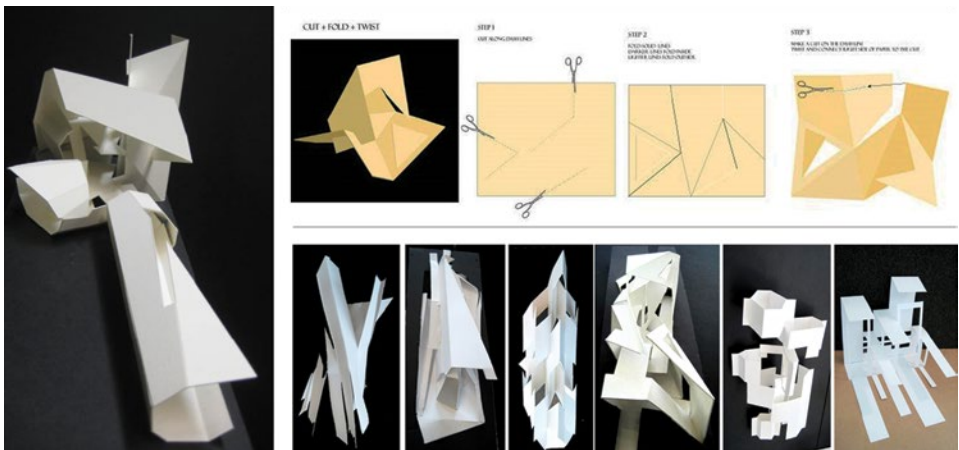

Fig. 05. The act of folding and discovery of unexpected spatial enclosure

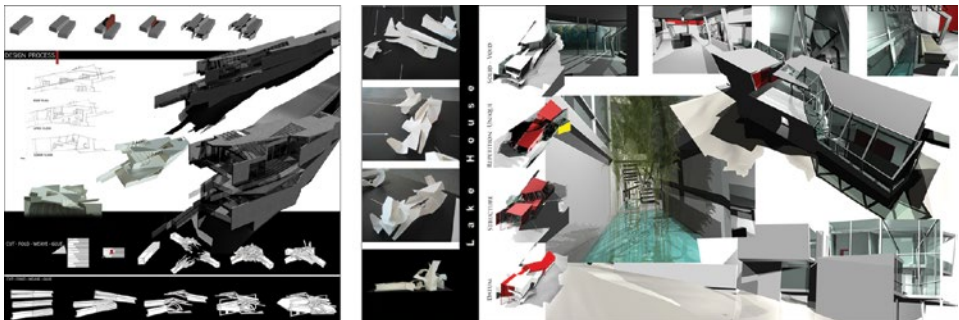

Fig. 06. Iteration of folding transformed to functional design

Through computer application

The tendency to depend on 3D computer modeling application is an evident recent trend for the generation of spatial form. Often in this method students depend

on manipulation of platonic geometry through software parameters. Use of various commands such as extrusion, loft, sweep, revolve, boolean, morph, path blend, skin, stitch, etc. are used to generate an overall form which although a valid process most often becomes a surface enclosure without much consideration of structure, site, program, and climate.

Visual Design Language, Product Design, and Fabrication in an Architecture Course

In the absence of a clear strategy of teaching ‘principles of design’, an elective course was introduced by the author to help students strengthen their understanding of visual grammar. The course had three specific goals: 1) use of visual design principles to design a series of everyday used products, 2) application of visual graphics for functional objects, and 3) use of digital software and hardware to fabricate designed products.

With the primary objective of linking art and architecture and use of technology, this course was an offshoot of traditional architecture studio. Assigned projects included design of dinnerware, a pair of sandals, 3D wall art, a painting based on built environment motif, a working clock, and a working lamp.

The course demonstrated that the execution of a design task and its assembly-fabrication using manual and digital equipment can be learned through projects that are not necessarily architecture based and do not have complex tangents of site, climate, program, etc. It concentrated on conceptualization, design, drawing, modeling, fabrication, and construction of three-dimensional every-day used objects using visual graphics and spatial and material compositional strategies.

The central theme being visual grammar, each project dealt with specific tangents of visual design principles.

Dinnerware project

Gathering, adapting, and transforming two-dimensional graphic motifs from various sources around us and then applying them to dinner plate design for unique visual expression was the objective of this exercise. The technique that followed was to create a composition using manipulated photographic image that express one or more of these design principles, such as: repetition, progression, movement, gradation, radiation, rotation, anomaly, contrast, concentration, hierarchy, and focus. Highlighting the features of overlap, size variation, and figure-ground are some techniques that were encouraged for graphic composition.



Fig. 07. Visual graphic motifs applied to dinner plates

Architectural painting project

This project was introduced to students as a free expression of elements of architecture through fine art on a framed canvas. Color, composition, texture, superimposition, and figure-ground were the principles explored through the techniques of spatula, oil paint, and canvas.



Fig. 08. Painting on canvas exploring information, composition, texture, color through elements of architecture and urban design

Time device project

This project focused on non-physical (perceptual) nature of time that requires visual images to transform its perception. Re-visualizing the time scale, its units and proper visual graphics and movement were the objectives. The goal of this project was to initiate awareness in these areas:

- exploration of visual design/graphic vocabulary in a product design
- connection between art, product and architecture
- role of technology in creation of form, geometry, pattern, solid-void

Footwear project

The highlight of this project was to exercise design principles and construction techniques through two pairs of sandal design: one emphasizing applied graphics and the other emphasizing unique design and construction. Functionally, both pairs had the same goal of travel transportability and interior use. Evaluation Criteria included:

- Design and functionality
- Material use (minimal) and comfort
- Construction technique
- Graphic strength
- Quality of finish



Fig. 09. Footwear exploring new tools and fabrication through materials

Lamp project

This project looked for references from architecture, applied graphics, and elements and principles of visual design. Students were asked to formulate three design

ideas based on 1. architectural precedents, 2. surface to volume (using techniques of fold), and 3. repetition of elements and modules to create geometry and form. The Applied graphic motifs reflecting abstract composition using point, line, etc. for light disseminating screen were encouraged. Highlights included:

- Form and geometry
- Light quality
- Construction technique & finish
- Graphic strength

Conclusion

As new tools and techniques evolve, the education of architecture studios seems lately to be moving away from teaching ‘principles of design’ and leaning towards exploration of entities that are not directly related to architecture. At one end there is this abstract notion of “Phenomenology” in design thinking and on the other end there is this practical use of “Robotics” for construction. Both deal with specific aspects of theory and application. However, it does minimize the ability to design spaces with utmost efficiency for human civilization which still is the primary goal of an architect. The new generation of faculty seems to gravitate to prematurely introduce technology in early studios that are a direct reflection of their own research or recent doctoral topic, or trends borrowed from other renowned schools. One such example would be the latest trend of experimentation with an “Arduino microcontroller” that has a nearly limitless array of innovative applications for everything from robotics and lighting to games and gardening. It’s a fun way to automate and enable to control simple devices or manage complex entities with sensors and moving elements.

The question remains, are we moving away from teaching basic principles of design? Is our goal to create philosophers who are good thinkers and writers, or, do we create scientists that are good at using microcontroller to move complex machineries? Or, do we educate designers that are more proficient in designing spaces and architecture for people?

Bibliography:

- Anthony, Kathryn. *Design Juries on Trial: The Renaissance of the Design Studio*. Van Nostrand Reinhold. 1991.
- Baker, Geoffrey. H. *Le Corbusier: An Analysis of Form*, Van Nostrand Reinhold, New York. 1997.
- Barker, J., and Tucker, R. N. *The Interactive Learning Revolution: Multimedia in Education and Training*, Kogan Page, London / Nichols Publishing, New York. 1990.
- Bonnici, Peter. *Visual language: The hidden medium of communication*, RotoVision SA, The University of Michigan. 1999.
- Carmo, Mario, “Ten Years of Folding,” *Architectural Design Profile: Folding in Architecture*, 2004.
- Clark, R. and Pause, M., *Precedents in Architecture*, Van Nostrand Reinhold,

New York, 1985.

- Dutton, Thomas A. *Voices in Architectural Education: Cultural Politics and Pedagogy*. Bergin & Garvey. 1991.
- Ernest L. Boyer and Lee D. Mitgang. *Building Community: A New future for Architectural Educational and Practice*. 1996.
- Falk, D. R., and Carlson, H. L., *Multimedia in Higher Education: A Practical Guide to New Tools for Interactive Teaching and Learning*. Learned Information, Inc. New Jersey. 1995.
- Leupen, Grafe, Korning, Lampe, De Zeeuw. *Design and Analysis*. Van Nostrand Reinhold, New York. 1997.
- Lynn, Greg, "Introduction," *Architectural Design Profile: Folding in Architecture*, 2004.
- Unwin, Simon. *Analysing Architecture*, Rutgurd, 1997.
- Wong, Wucius. *Principles of Form and Design*. John Wiley & Sons, Inc. 1993.

Filmmaking, a method for teaching urban design: *Narrative, plot, characters, and action for urban spaces.*

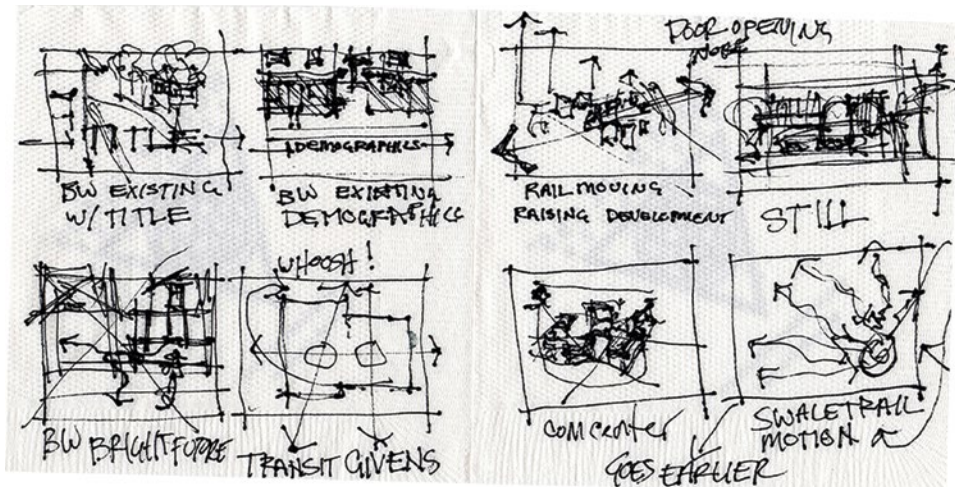

Fig. 01. Napkin storyboard concept exploration,
David McCarel, MUD 2017

Introduction

Working with multidisciplinary groups of graduate urban design students led us to a new significant design method. Using movie-making video production combined with storytelling logic helped us envision and proactively design urban spaces. Using this technique, the students' graphic course led the way for the design studio, providing the class with an effective platform for cross-course integration for both faculty and students across the curriculum. The technique deliberately melds conceptual thinking with the representational process. Relying on critical questioning of scene-setup gave us a productive process for the creation of dynamic urban spaces. The project brief essentially challenges each student to write and direct a short movie explaining their proposed urban design. The required cyclical reinvention of the storyline, while also reconsidering action sequences and the construction of principal characters, gave the students a new rich urban design method. Imagining their scene-sets, the mood of the

story-space, and the meaning of place, became each designer's aim. The setting is continually tuned through noteworthy criteria such as land use program mixes essential to making the video more interesting and symbolic. The designers holistically explore spatial ideas optimized for cultural experience and social justice. The method, as well as the easily accessible digital technology employed, give the students new means to imagine, inhabit, and shape places for human interest. Students virtually walk their proposed streets and plazas thus critically assessing design, program, purpose, intent, and their relationship to the users. For example, a discussion of scene audio and the need to tell the story through sound, presented the students with an additional medium to develop rich design ideas. Many, subsequently and surprisingly, found their current spaces too inert or boring. Also, students quickly overcame their designer block, and developed places deeply connected to their intensions, and the culture of their site. Discussions ranged from social justice concerns, such as gentrification, to the cultural merits of their idea, "is this what the neighborhood needs right now?", or "What are the technical challenges presented by the design?"

This paper outlines our process as well as the technologies used to integrate traditional sketching with 3D modeling, video production, and editing techniques.

Background and intent

Our program's four-decade experience in community-based design completing over three hundred urban design projects for Midwestern US communities taught us that when attempting public presentations, real world depictions through three-dimensional imagery is far superior to any other drawing format. Architectural plan and elevation drawings are inaccessible to the lay public. We base our own design communication strategies, primarily on axonometric and perspective drawings. These experiences led us to the logical evolution of our current format of full animation and film development. The remarkable and unexpected discovery was that not only movies are effective and powerful means of communication, they offer a process for enriching, evolving, and designing urban spaces. Graduate students started to rely on their film development and the associated techniques to study and adjust their public spaces. The eye of the user suddenly gets control of spaces using the camera. Issues of scale, space definition, proportion, use, and level of interest are quickly brought to the forefront. Every element of the scene is in fact symbolically important and must be useful to reinforce and connect the story with the audience. For example, in past representations, students thought very little of the entourage used in their constructed scenes. In contrast, a film entourage is central and essential for the fullness of the story. Entourage like automobiles, costumes, activities, and corresponding spaces must be studied for meaning and importance. Furthermore, the students must test and adjust their space activity program to ensure that the design engages and appeals to land use mixes that would be supported and desired by the community, as confirmed by the film plot and the scene context. Past projects did not allow for such depth of engagement because representation became a step in the process that follows design decision making. A rendering is after the fact and only intended to show what has already been predetermined. For these reasons, the film design process provides a powerful platform for testing spatial interest.

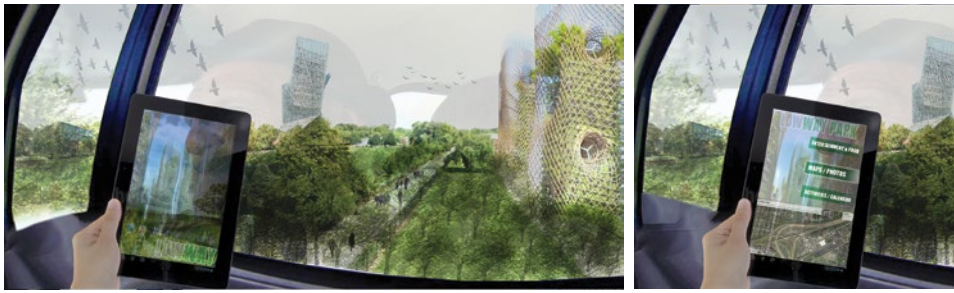

Fig. 02. Studying symbolism and communication strategy.

Source: William Morales, MUD 2017

Methodology

Start the film before the design is complete

Our discovery was largely due to the limitation of the semester schedule. The movie project in the design communication media (DCM) course must be started well before the urban spaces are designed in studio. Typically, the students establish an urban framework design the previous semester but have very little details for their public spaces. So, we asked each of them to develop a 2 to 3-minute-long movie presentation to explain their urban design. The project brief requires the authors to represent three scales (monumental, intermediate, and intimate). The scales are explored through three dimensional digital sets, designed specifically for each scale. The students were also advised to think of a unifying design element that would connect and string their movie action sequences and develop clear continuity among the scenes. The need to identify hierarchy of spaces in the framework design is the first necessary decision for the students. This order of importance, offers clarity to the designer. The study of activity programming and intent follows the two previous steps. Finally, an expanded conversation regarding the cultural attributes and vision of “quality of life” raises questions regarding the design’s cultural fit. The question being, is this proposal ‘in culture?’ These discussions are lively and charged with emotions. Issues of social justice and fairness become critical and integral to the designer’s ethical responsibility to the public, their clients, and the users: Is the design consistent with the aspirations of current residents? Who are we designing for? Is gentrification inevitable? Are there winners and losers? These discussions explore the heart of urban design as a profession and carries the most interesting revelations about design process and social justice, for both faculty and students. Furthermore, since space must be actively viewed through the camera lens, the designer’s intellectual perspective must be humanized and experiential, improving their space design.

How to begin? Review of professional urban design short movies

Composing a Killer Still

At the start of the semester the class is assigned the study and development of a single perspective frame we call “killer still.” This project initiates the primary considerations for the movie. This “still” is in effect, a moment in the movie. Narrative, characters, time, and entourage are all in service of the story. The still is also the means to ease the group into familiar technology. Students enjoy having the extended period to design and compose a single frame. In many cases, especially for the non-design students, these are new considerations that are being studied for the first time.



Fig. 03. Activity assessment identifies limitation of land use mix – Still Study –
Source: Daniel Wevik - MUD 2017

Start of the Movie project

In the first session of the movie project, the class reviews and analyzes exiting productions by major urban design practices. The medium is highly effective and is in active use by most international urban design practices. As we review professional productions as precedent, students are typically focused on concerns of technology and animation techniques rather than the conceptual makeup of the movie—it is the how that fascinates them. However, what is more useful is to understand communication strategies and movie elements designed and used to string the action sequences and develop the storyline, and how the look and feel of the presentation closely aligns with the spaces and the design intention. Squint Opera, a successful international practice based in London, with offices in Melbourne, New York, Dubai and Sao Paulo provides the class with a rich library of design movies carefully prepared to promote major international projects including Masdar Eco City in UAE, the Brazil Olympic Village in Rio, Brazil or other major US and European developments. Reviewing this work offers the students the opportunity to understand how professional illustration houses have been engaged to explain and promote large urban development.

In the second-class session, the students bring their own precedent examples to share with the class. Each student screens their video, and discusses its communication strategy. Students are asked to explain why they choose this specific example. This exercise helps the students launch their own production, already aware of the stylistic and strategic directions they intend to take their movie.



Fig. 04. Storyboards study reveals spatial hierarchy and develops a production schedule.

Storyboard

The review of precedents provides the students with clarity of intent, examples of strategy, sample look and feel, assisting with the development of a story via a storyboard identifying major scenes, and the progression of different action sequences. The storyboard should also lead to a production schedule describing model and design elements necessary to complete each scene. The storyboard is also an important guide for the designer to clarify hierarchy, production schedule and intensity of time needed to produce the movie. The story board is an opportunity to explore and expand the narrative for each space, determine the main characters, and define the principal action sequences.

Development of the first film sequence

The first screening, if done in a group setting, allows for team interaction leading to enjoyable creative discussions that contribute to project clarity, definition of intent, and the narrative’s evolution through the study of each passage. Reviewing classmate’s scenes, in pinup mode, also assists with technical collaboration and troubleshooting technical challenges. The success of the first scene is critical because it removes the student’s fear of the new medium.

Rough Cut Screening

The first milestone of the project is the completion of a rough cut of the full movie. The rough-cut review is extremely helpful for the students because it is a chance to contemplate the work in its entirety. Missed opportunities are easier to detect and resolve through active brainstorming. The class is now very skilled at identifying the embodied potential of specific scenes, noting logical disconnect and dispersed focus. Camera tracking and other production details are explored in specific: What point of view should the camera be interpreting? Is the viewer a participant, or observer? Is the scene explanatory or exploratory? The medium demands that the author thinks profoundly about every aspect of the space. Although the same is true for still image development, the need in this case is amplified by movement through the space which renders the necessary understanding of the movie set more urgent.

Technology used

The first statement of the instructor to the class may be summarized as: “this course is not about technology, nor is it about software training.” In fact, the students

use a suite of software to accomplish their movies. No one software can provide all what is needed for the messaging of all scenes. The focus is more on the study of storytelling and communication theory, while fostering an understanding of the audience, and a deeper knowledge of cultural, social, and economic factors affecting the urban environment and the physical space in question.

The movie production technology we use evolved drastically through the past seven years. Early in the course's history, students were introduced to Autodesk's 3D Studio Max, Sketchup, Adobe Premiere, Adobe Flash, and After Effects. 3D Studio Max proved to be a major challenge for most students, especially for students from non-design backgrounds as the software requires several hundred hours of training to be useful. Currently our modeling relies on Sketchup Pro, while rendering is predominately done using Lumion 3D.

Outcomes measures

Student perspective

The students reacted extremely positively to the movie making process and technology. Through post production reflections well after the course completion, they consistently indicated that the movie making had a direct and significant impact on the space development of their project. Some credited the movie inclusion in their portfolio with their ability to secure a job in their present design firm. It seems having had an experience with the medium was deemed very valuable by employers. Student interviews identified several important benefits. Understanding scale and proportion is the common thread identified by several cohorts from different classes and years. In addition, important aspects were highlighted by different students:

- “The ability to identify and prioritize design focus. I discovered what was critical for the design by the proportioning of screen time allotted to some spaces and less to others. This action had to be carefully considered against the storyline and the main objectives,”.



Fig. 05. Study of Scale and activity mix of urban spaces

- “The camera eye gives the designer a more personal feel for the space. I proposed a bridge as part of my design. In the past I felt the bridge space as one block and undifferentiated offering only one character regardless of the user's position on the bridge. Through the movie, I could distinguish the several unique spatial qualities of each part of the bridge. The medium and simulation helped refine my conception of this unique space.”

- “Scale and density became a lot more apparent as I was building my scenes. Through my movie, I discovered that some high rises were clashing and are presenting scale and proportion problems. The movie made me detect the problem.”
- “Use of entourage including birds and animals changed my spaces and led me to consider issues of bio diversity in public spaces. Even the ability to introduce fountains and moving water as is possible with lumion prompted me to reshape and rethink my design”
- “Sound considerations and design was truly a new way for me to study space. It is a different way of testing and expanding the designers vision of the space.”
- “Now when I see a plan I start to imagine the movie inspired by the plan. It gives me a way to evaluate the level of activity and human experience.”

Studio Faculty’s perspective

Our Master of Urban Design Communication Media (DCM) courses are closely coordinated with the design studios. In fact, the DCM movie and all other communication pieces are in direct support of the design studio. Studio faculty are often invited to participate with the review of the movies from conception to completion. What is remarkable is that often the first scene is what gets the studio projects truly launched. The movie design initiates the ability of the students to start walking their streets and in turn start design conversations about activity programming, appropriate land use mixes, and intent. Here are some of the studio instructor’s feedback regarding their experience with their students and their use of the DCM movie techniques in studio:

About the success of the pedagogy one colleague said “You’re teaching them a new medium, skipped over all their inherent fear about drawing and got the students to use the new presented movie making tools to explore and shape spaces. The Movie project asked them to first build their urban spaces as simple cubes representing buildings. Then streets were formulated showing street amenities, urban trees, people, and started featuring urban furniture and civic amenities. So, character is added. So now they had to react. A sort of evolutionary causal/effect that get the design initiated.” The introduction of increasingly developed elements required the evolution of the whole scene and especially the development of the architecture and the landscape.

The movie making process transformed the design method from a simple linear thinking progression to a circular iterative loop...”

They added “in a way it’s like giving students a new color to use. A new way to think of space. They took these as their own, and once they worked with it, they felt proud of the accomplishment because other design students were not using this medium.”

Finally, the faculty felt this technique empowers the students. They can conceive and explore space in a way that others did not. This distinction added to their portfolios and, in some instances, got them jobs.

Closing the loop

Movie making as a design medium utilizes a feedback loop and mechanics that informs the designer's understanding of the experiential and human dimension of their proposals. The process itself is simultaneously a study, representation, and design. The ability to examine spatial decisions by virtually walking through the design, fulfilling a narrative carefully constructed by the designer, is a way to polish the spaces and maintain conceptual integrity. The narrative, the story, and the characters help the designer be consistent and stay faithful to his or her design ideas.

References

Lockard, Kirby. *Drawing as means to architecture*, Menlo Park, California: CRISP PUBLICATIONS INC, 1977

Crowe, Norman and Laseau, Paul. *Visual notes for architects and designers*, New York: John Wiley and Sons, 2012

Ching, Francis D.K. *Architecture, form, space and order*, New York: John Wiley and Sons, 1996

Designing Socio-spatial Infrastructures with Time in Mind: Reimagining Istanbul Sali Pazari

Introduction

The financial crisis of the 2007-2008 and the austerity measures adopted by the governments have moved alternative approaches for making urban spaces to the centre stage (Pak, 2017). Ordinary people all around the world have started to claim a shaping power over the processes of urbanisation; over the ways in which our cities are made and remade (Harvey, 2013, p.5). In literature, these have been given a variety of names such as: “DIY urbanism”, “make-shift urbanism”, “austerity urbanism” (Tonkiss, 2013).

In contrast with traditional urban production modes, a key characteristic of these practices is the employment of design tactics grounded in time (Franck, 2016). Among those are temporality, openness, ad-hocism and novel approaches to aesthetics which enable the continuous representation of the user needs (Pak and Scheerlinck, 2015). These emergent practices clearly illustrate a shift from strategic thinking to tactical thinking; establishing a different understanding of power and time. In this new paradigm, strategic design is framed as centralized, top-down, slow, expensive and complex urban governance practices disconnected from the people (Lydon & Garcia, 2015) whereas tactical design is preferred as a novel empowering mechanism: bottom-up, agile and decentralized means for ordinary people to challenge the status quo (de Certeau, 1985).

In this context, this research paper will discuss a Master’s Dissertation focusing on Istanbul Sali Pazari district embracing temporality, incrementalism and self-organized change as key elements of urban design. Acknowledging the dynamic and mutable character of the project site, it investigated the city’s complexity, considered as a mutating organism, looking at the way the past actions had modified the predefined conditions of the studied urban environment. The research questions were:

- How can we design socio-spatial infrastructures considering architecture as a process?
- How can we envision the future of a spatial intervention incorporating incrementalism and self-organization?

The Istanbul Sali Pazari Project

Sali Pazari is a historical site at the foot of the valley of Kadikoy, on the Anatolian side of Istanbul, which has been for centuries an important collective space. The studied site, indeed, used to host one of the most popular ‘bazaars’ of Istanbul that, besides being a suitable place for trade, has been the area on which the local community built up its social identity. During the second half of the century, the construction of the Haydarpasa railway station cut the district in two parts: the coast side mainly programmed to host facilities for the harbour and to allow the commuting of the users and the inner part, mainly residential and commercial. From that moment on Kadikoy started being an important transportation hub. Today the Sali Pazari has completely lost its collective quality since the area has been re-converted and re-programmed to host these new facilities. As the main consequence, the area that used to host the bazaar has been converted into a car parking, and furthermore, resulted in the local producers having fewer and fewer possibilities of pursuing their occupations due to an on-going gentrification process.

The research implemented in the Sali Pazari area has focused on some specific ‘time sections’ which are considered to be relevant not only to the understanding of the actual urban configuration but also regarding the social organization of the district. Overall ‘Temporality’ has been here used as a research filter to investigate the complex and diverse forces that have shaped the urban fabric of Kadikoy in the past (such as the construction of the Haydarpasa Railway). The main aim was understanding how the social fabric has reacted to these shifts and which kind of social target could be integrated into a requalification strategy to preserve the strong sense of identity that the district is gradually losing.

Together with the ‘time sections’ analysis, the recognition of the importance of time in the architecture process revealed another perspective on ‘space and time’, which focuses more precisely on the local scale of the studied context: the public space appropriation tactics.

In particular, a research on the different urban tactics used by the local actors to temporarily appropriate the urban space, emphasised how

the social identity of Kadikoy is strongly strengthened by its multicultural social fabric and especially by the incredible diversity of small producers and crafts that invade the streets, extending their local businesses and animating the urban space. The local entrepreneurs and the informal economies, indeed, represent the studied district not only an important catalyst for the local productivity but also a relevant cultural factor on which the community has structured itself right from the start.

As a first step, a spatial research on the modalities of temporary appropriation of the urban spaces, made from a streetscape perspective, led to the identification of a specific social target, which has been negatively influenced by the gradual shift of the Sali Pazari site from an open collective space to a mere transitional space.

Secondly, the mapping of the local business activities has confirmed the presence of an incredible diversity of producers and informal actors already active on the site. Some of these producers were owners of local shops, others were running an informal business. In a transportation hub like the Sali Pazari, where every day several

commuters pass through, this diversity of producers generates a significant space for negotiation, where the different actors of the local community can daily share their goods and services for a common purpose. However, this ‘social capital’, which is a temporary condition dependent on the level of openness and availability of a public space, is in risk to be broken up by the adverse effects of the on-going processes of gentrification and privatization affecting the site.

Among the different social actors considered, the street sellers represent an important part of urban informality as they provided entrepreneurial opportunities to people who cannot afford to buy or rent fixed permits. That is the reason why they managed to facilitate the integration of marginal groups and migrants in the local economy. Informal economies are, in other words, the first promoters of a super-diverse community. Moreover, the street sellers and in general the informal economies are important for the Sali Pazari community because they represent a relevant part of the Turkish urban life. They bring life to dull streets by providing atmosphere through their colourful stalls, costumes, and merchandise (Bromley, 2000).

Overall, the recognition of a social target and a specific research on the temporary urban devices daily used by the informal producers invading the streets of Istanbul (food-seller charts, flexible bazaar tents and other temporary structures) have been a fruitful and robust basis to implement a coherent bottom-up urban strategy; a strategy based on different time stages which aims to re-integrate the local producers in the urban life of the district.

Urban strategies linking space and time

The main strategy for the rethinking of the Sali Pazari site was to follow a ‘generative process’ that involves developing scenarios imagining the engagement of different local productive actors in the process following different stages.

Stage 1: The Urban Generator is the first ‘element’ of the generative process for the rethinking of the Sali Pazari site. The conversion of the present fire station in the Sali Pazari site into a Craft Factory aimed to integrate the existing local businessmen in a productive process. After the new Craft Factory (Urban Generator) is active, the wall enclosing the site will start to open-up (Step 1). Then, the injection of the first Social Infrastructures, which are a system of iconic buildings both able to offer basic infrastructures and to act as social landmarks for the commuters and for the local producers, will activate a process of appropriation of the unused space (Step 2). As a first consequence, a dynamic platform, called Super-Diverse Cluster, generated by the Social Infrastructures, will start extending based on the use and the needs of the users to create spaces for co-working, for private business and for other collective activities.

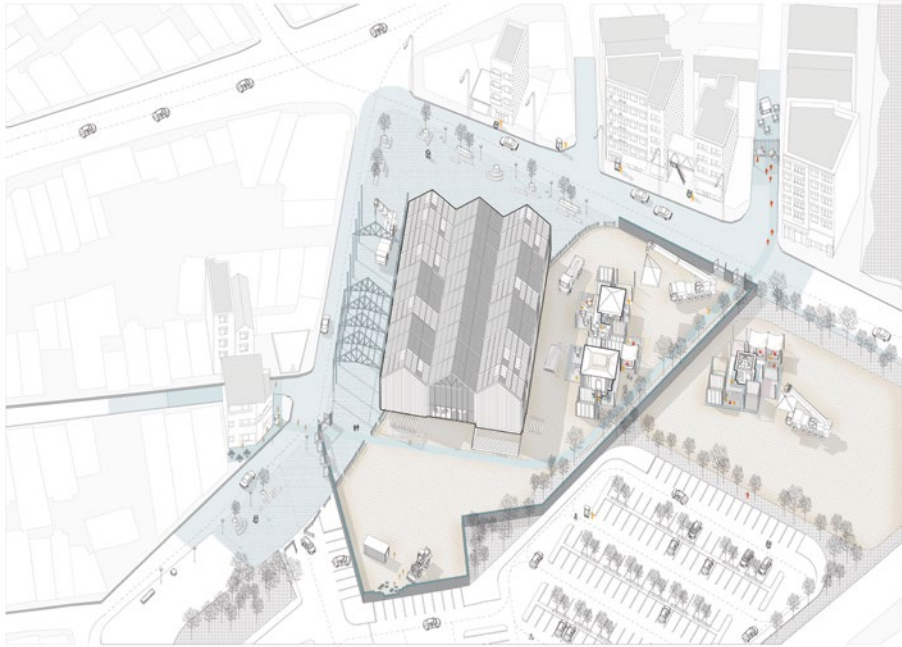

Fig. 01. Reimagining Sali Pazari: stage 1

Source: 'City in/for Transition'. Master Dissertation, KU Leuven, Boeri, A., Pak, B. (promoter)

Stage 2: All the different stakeholders and local actors start being involved in the productive process. As a first step, the extension of the craft factory, the permanent food market, will open to the public. The Craft factory, now completely productive, will start generating every Tuesday a temporary Bazaar, where the furniture and devices produced in the factory will be sold (Step 4). Meanwhile, the injection of other Social Infrastructures will extend the Super-diverse Cluster in the site (Step 5). Finally, a range of temporary urban devices will be produced by the local craftsmen: informal carts, strategic urban furniture, and temporary structures will be injected in some specific critical areas in the surrounding of the Sali Pazari site to encourage a process of re-appropriation of the collective space in favour of the local producers (Step 6).

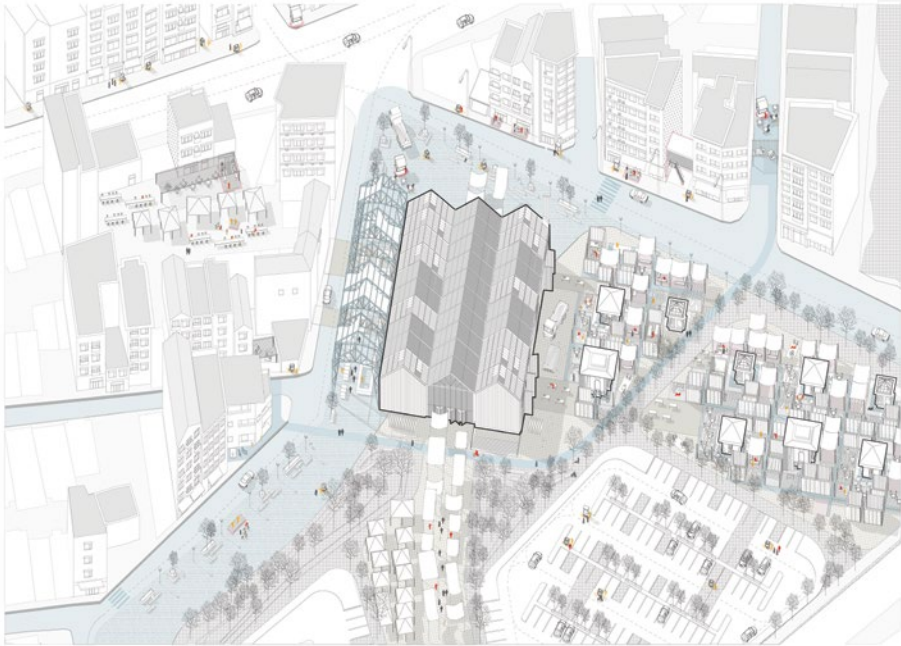

Fig. 02. Reimagining Sali Pazari: stage 2

Source: 'City in/for Transition'. Master Dissertation, KU Leuven, Boeri, A., Pak, B. (promoter)

Conclusions

The research-to-design approach presented above proposed a “master process” which incorporates in its own functioning the tools to deal with complexity, conflicts and changes, and that will be supported by the diagnosis, plans, and projects already realized in the city during the last decades (Ecosistema Urbano, 2011). This particular method is an attempt to make a novel link between space and time, which aims to overcome the past conception of programmatic stasis, by starting looking at the urban-architectural project as a ‘process of change’: a) understanding space and everyday activities through time and b) creating space-time scenarios for an urban project.

In relation to these, the following findings were significant in terms of the design affordances of the followed method:

1. As a first research step, the analysis of different ‘time sections’ throughout the recent history contributed to understand the actual urban configuration and social organization of the district. In this initial analysis, ‘temporality’ turned out to be a necessary research parameter to understand the real needs of the users, especially considering the actual urban stagnation of the Sali Pazari site: a parking lot only used as a mere transitional space. The ‘time sections’ analysis, the comparison of the actual programmatic stasis

of the site with its past dynamic urban condition, revealed in particular how the displacement of the Turkish bazaar had negatively influenced the urban life of the district, depriving both the commuters and the local producers of an important collective space. In this sense, the ‘time sections’ analysis helped us to identify a novel link between time, space and social identity: these are interlinked research tracks which are necessary specifically for urban contexts which have been re-converted and re-programmed over the past decades, such as Sali Pazari.

2. The urban strategy proposed for the Sali Pazari site is based on a ‘generative process’ that involves developing scenarios imagining the engagement of different local productive actors in the process following different stages. In this sense an ‘ad-hoc’ research on the actual social target and on the tactics of temporary appropriation of the urban spaces had been relevant tools to understand which social-productive cycles should have been included in the strategy.
3. Furthermore, the research on the informal local productivity and the appropriation tactics led to envision a possible bottom-up process whose ambition is to regenerate an open collective space, by supporting a self-organization of its users.

In conclusion, the Sali Pazari research-to-design process has explored space and time as essential research drivers for the urban contexts that, besides dealing with an urban informality, have been shaped by a range of urban transformations over time. In this sense, Temporality is considered imperative for both understanding the users’ needs and envisioning a bottom-up urban process directly supported by the local actors. After all, if human use and experience, which necessarily happen over time, are excluded from architecture as anticipated, how can they ever have a place? (Franck, 2016).

References

- ⁶ Ray Bromley, Street vending and public policy: a global review, (The International Journal of Sociology and Social Policy, 2000).
Bromley, Ray (2000). Street vending and public policy: a global review. The International Journal of Sociology and Social Policy.
De Certau, Michel (1984): The Practice of Everyday Life. University of California Press. Los Angeles.
Ecosistema Urbano (2016) Master Plan Competition for the Historic Downtown of Asunción Retrieved from <http://ecosistemaurbano.org/english/ecosistema-urbano-wins-the-master-plan-compe>.
Franck, K. A. (2016). Architecture Timed: Designing with Time in Mind. John Wiley & Sons.
Lydon, M. Garcia, A. (2015). Tactical Urbanism: Short-term Action for Long-term Change Island Press. Kindle Edition.
Harvey, D (2013). Rebel Cities: From the Right to the City to the Urban Revolution, Norton. Kindle Edition.

- Iveson, K. (2013). Cities within the City: Do-It-Yourself Urbanism and the Right to the City, *International Journal of Urban and Regional Research*, 37(3), 941-956.
- Lydon, M. Garcia, A. (2015). *Tactical Urbanism: Short-term Action for Long-term Change* Island Press. Kindle Edition.
- Pak, B. (2017). Strategies and Tools for Enabling Bottom-up Practices in Architecture and Urban Design Studios. *Knowledge Cultures*, Special Issue (5) 2 (Learning, technologies, and time in the age of global neoliberal capitalism).
- Pak, B., Scheerlinck, K. (2015). Learning from the Urban Commons in Flanders and Brussels: Paesthetics. in : *The City As A Commons: Reconceiving Urban Space, Common Goods And City Governance*. The International Association for the Study of the Commons (IASC), 2015 Thematic Conference on Urban Commons. Bologna, Italy, 6-7 November 2015.
- Tonkiss, F. (2013). Austerity urbanism and the makeshift city. *City*, 17(3), 312-324.

Diana Nicholas^a, Shivanthi Anandan^b

^a URBN STEAMlab, Department of Architecture + Interiors, Drexel University, Philadelphia, USA

^b URBN STEAMlab, Department of Biology, Drexel University, Philadelphia, USA

Integrated Space: The Novel Design Research Experience

Introduction

“From masonry bricks to multidimensional voxels, architectural design is possessed with the search for synthesis. Motivated by new scientific discoveries, such enquiries are now advancing new ways of thinking and making architecture.”¹ New bio driven space making strategies are imperative in the 21st century. Our ability to integrate form, with material tool and system is imperative in this demanding age in which efficiency becomes essential. Bio-design, a term with a long history that was introduced and explained to the public by Neri Oxman in her 2015 TED talk, is “The use of living things such as bacteria or plants in designing products or as art”² Biodesign in the urban environment creates new levels of community resilience, through allowing communities to prosper, and maintain their core residents, residents who are often displaced by the lack of healthy options in the urban environment. Biodesign when coupled with the lens of resilience becomes a strong way to maintain communities and build equity in the urban environment. In a nutshell, resilience is the staying power of a system, including buildings and neighborhoods. To create resilience, adaptation is necessary, and this can include building on the identity, values, social cohesion, and the physical environment of the system.³ USL Believes that bio design and resiliency are important components of the solution for retaining both people and buildings in urban settings. Through a novel indoor hydroponics system for plant growth to grow food in urban food deserts this trans-disciplinary lab works to create solutions that are both freestanding and integrated into the structure of the typical urban row home. In this process, we provide a mentoring and training experience for students focusing on creative problem-solving, science, and technology. According to United Nations Environment Program (UNEP) rapid urbanization will continue and they further predict that more than 80% of humanity will live in cities by 2050. UNEP states that planning and management of urbanization is critical, emphasis must be

¹ (Oxman 2011)

² (“Definition of Biodesign | New Word Suggestion | Collins Dictionary” 2015; Oxman 2015)

³ (Lerch 2015)

placed on how cities source, process, and use resources with an eye towards building resiliency in future conditions.

USL's focus on developing an indoor plant hydroponics system powered by sustainable fertilizer contributes significantly to the choice and use of resources available for urban living. In addition, traditional science, technology, engineering and mathematics (STEM) fields in this country are currently struggling to attract sufficient numbers of students, reflected in the US ranking 27th amongst developed nations in the proportion of college students receiving undergraduate degrees in STEM. At the same time, design is becoming increasingly complex, and evidence based, with informed driven design processes becoming the new normal.⁴ USL's approach addresses this deficiency in knowledge and hands-on experience amongst STEM and design based university graduates, while offering a solution to a pressing need. USL mentors young design professionals, researchers and scientists in the 21st century skills necessary to meet our current and near future challenges.

We train students to collaboratively engage in science, design and innovation using experiential learning, focused on designing and prototyping small and portable interior hydroponic and soil-less plant growing units that can act as decorative table-top, bookshelf or window units in an urban row home. These growing units will eventually contain nitrogen-fixing cyanobacteria to generate fertilizer for plant hydroponic growth. The design and innovation of these growing units integrates design with STEM and will provide a sustainable solution for food production for the urban population. By doing this, we will also be training a new generation of future leaders in their fields, who possess trans-disciplinary research experience(s) as part of their professional development, which will positively impact their fields of work. We have tested this innovation model with undergraduate students over a period of two years, and successfully developed several prototypes that are being tested.

URBN STEAMlab Process

Our approach addresses key social, cultural, ecological and technological factors in the following way. Once implemented in urban row homes, USL's hydroponic system would give urban inhabitants a way to cultivate plants for food without using commercial fertilizers. This method would increase the arable "land" available for food production, and addresses the social equity topic of food availability for all urban dwellers. USL changes the culture in which research and innovation in STEM and Design occurs. USL's trans-disciplinary model crosses disciplinary boundaries and engages students in the culture of problem-solving in a real-life setting addressing real world complex problems. Additionally, USL's hydroponic plant growth system has a very low impact on the ecology of the region. It does not require the use of commercial fertilizers, or the use of soil. Moreover, by bringing food production into the home, the urban interior environment serves as an additional green space for its inhabitants. This green space will have a positive impact on the wellbeing of the inhabitants. USL combines the use of Design and Biology to generate a usable model

⁴ (Chong, Brandt, and Martin 2010)

for plant hydroponic growth. This combination of Biology and Design changes how technology is perceived in innovation, and crosses disciplinary boundaries.

USL's strategy is unique in three main ways. First, it is a process that formally brings together STEM, Design research and evidence-based iteration a three pronged method that mentors a new generation of both STEM and built environment leaders. Second, USL works to create one mode of thought across multiple disciplines to establish a new knowledge base that can be drawn on to solve the complex problems driving climate change and lack of social equity in our society. USL develops trans-disciplinary problem solving as a new knowledge base for the 21st century. And third, USL examines social equity in design as the driving force for change in underserved living environments. Our project is driven by the need for there to be a safe healthy and equitable living environment for all urban dwellers. Although design is often considered a conduit for this, many in urban communities also lack access to designers, and design thinking for their living systems. Just designing for the underserved is not good enough, we must design well for them, and this requires evidence-based practice.⁵ USL will implement a human centered participatory design process that includes outreach to the community in the coming year. Drexel university has built a strong relationship with it's neighboring communities Mantua and Powelton. The University has created an extension center that continues to drive community outreach and participation.⁶ The Mantua community is uniquely situated with a deep history, and culture. The poverty rate, is elevated in this community and it is a food desert. The neighborhood has strong leadership working to pull healthy living resources into the community.⁷ This project aims to not just provide a designed unit but to co-design with community, students, faculty, and interested parties. Planning for this co-participation process will follow the same tiered mentoring that the lab ascribes to, and may include side by side coursework in which community members and students learn together.

Our Biology-based design project includes prototyping small, portable interior plant growing units that can act as decorative units in an urban home. In these units, we use the ability of nitrogen fixing cyanobacteria to generate sustainable fertilizer for plant hydroponic growth. Certain species of cyanobacteria carry out nitrogen fixation, a process that enzymatically converts nitrogen gas obtained from the air to nitrate, that enriches the nitrogen content of the environment. We intend to harness this ability of cyanobacteria to produce fertilizer for hydroponic plant growth on a scale suitable for the urban indoor living space. Students participating in this project will be able to research/design and fabricate using 3D printing prototypes for cyanobacterial growth in urban interior spaces, test the ability of a variety of natural and synthetic prototype materials in supporting cyanobacterial growth, select for cyanobacteria that are optimized for growth in/on these natural/synthetic materials, and engage in iterative design processes. To reflect our goals, activities will be targeted to develop the novice student into a relatively independent and interdependent innovator.

⁵ ("An Introduction to Design For Equity" 2015)

⁶ ("The Dornsife Center" 2016)

⁷ (Mt Vernon Manor; Community 2013)

Context for the URBN STEAMlab Process

Traditionally, Biology has been a laboratory-based discipline, where experiments are designed and conducted to answer pressing questions of the field and time. Key processes in experimental Biology are identification of a focus for investigation, establishing a valid hypothesis that serves as the intellectual underpinning for the experiments, designing and conducting the experiment, and analysing the results generated by the experiments. The experimental data and analysis of those data serve to establish if the original hypothesis is valid or not. When the data do not support the hypothesis, the hypothesis is not valid, and must be revised and modified, and the experiments re-designed. When the data and analysis support the original hypothesis, then a clear path for further experimentation is established. Biology and Design overlap in many of the intellectual processes they use. Hypothesis generation in Biology is equivalent to the intellectual and human centered approach of Design, by serving as the foundation of the experimental and design processes. In Biology, the design of the experimental protocol is a significant part of the experimental process, since it strongly affects the outcome. Similarly, Design takes many “experimental” factors, both human centered and environmental, into consideration to bring forth a valid outcome.⁸

Design works iteratively, this lab uses and teaches the double diamond process that centers on diverging and converging thought in work development.⁹ Students iteratively produce options, that are assessed through a STEM lab based process and through a discussion of user driven needs, aesthetics and wants. Conducted to speculate around new forms of space making, these explorations grow from both convergent and divergent thinking models in which we work iteratively and synthesize our findings for problem-solving. Both modes are integral to design, and it is through a considered approach to these processes that we can work across traditional disciplinary boundaries. Iteration and the generation of options are key to this process and the knitting together of a design based process with a STEM lab process has created the opportunity for integrated proof on concept form the initial stages. The project currently has multiple prototypes at many scales and is working to integrate the bio needs into forms as they are deemed successful designs.

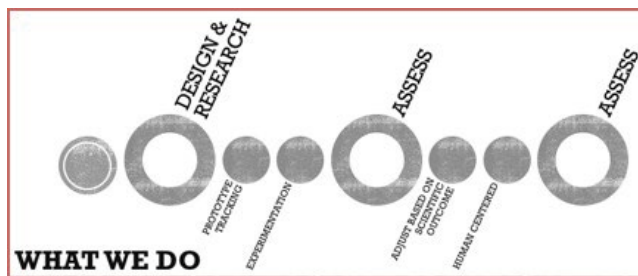

Fig. 01 & Fig. 02. USL iteration process—where divergent and convergent thinking happen in tandem to proof of concept with student poster showing this iteration, *Source: author*

⁸ (Owen 2008)

⁹ (Cross 2011)



Increased urbanization has required that food production be amplified to meet the needs of a growing urban population world-wide. However, there is a limit to how much arable land can be augmented, and this limits agricultural food production. The human race needs new ways to cultivate plants for food in an urban environment that is not dependent on soil. Additionally, inner city underserved inhabitants lack appropriate access to nutritional food and produce, establishing a social inequity. USL believes that new methods for addressing this social challenge are required, and that these new methods will require professionals trained in a trans-disciplinary manner in both STEM and human-centered design. Federal statistics suggests there will be a shortage of one million STEM professionals. USL approaches the national shortage in well-trained and competitive STEM students by exposing students to training in design thinking, with the support of a dedicated team of mentors. Our approach addresses and will alleviate this deficiency in knowledge and hands-on experience among STEM university graduates and professionals. Designing sustainable materials, products, and strategies for long term, environmentally friendly city living, is crucial for the overall health of the planet and its human population, and is a pillar of the USL process.

Conclusion

URBN STEAMlab's Impact/ Outcomes

“We must not be afraid of dreaming the seemingly impossible if we want the seemingly impossible to become a reality.” Vaclav Havel Quoted in Andres Edwards

“The Sustainability Revolution”¹⁰ Students in USL are impacted through their experience in this novel lab. Design and creative thinking as a valuable part of spatial innovation are well established- and the need for informed research-driven practices in the design of our built environments is an expanding area with broad positive implications¹¹We recruit and train undergraduate and graduate students annually. Current USL process works across various scales and disciplines, and the structure is a rigorously defined blending of Design and STEM based techniques, skill building and iterative development. The project process includes three phases that students will move through to develop the project and deploy solutions. The first phase is Form Development, where students work to develop and deploy speculative forms based in precedent and human centered research. In the second phase, STEM lab development, students test and deploy forms based on proof of concept driven lab procedures. In the third phase, as part of Evidence Based Design (EBD) development, students test and refine based on lab outcomes, and they also circle back to the human centered work to find real world success in their projects. The project teams meet as a larger group weekly and have dedicated space in which to produce their lab and studio based works both in groups and as delegated individuals. The interaction between the students, their peers and faculty mentors highlights the importance of strong interpersonal communication in a small group setting, and model the dynamics of a work environment. This type of communication is vital for information sharing and engaging in deep problem solving to produce successful research and design outcomes.

The idea of problem solving as a multi-disciplinary community exercise in relationship to STEM project development is emphasized as an integral part of the USL process, and occurs in the weekly meetings with peers and faculty. The training and socialization process provided by USL is designed to serve as a springboard for students to identify and develop their professional identity. Our mentoring process is also an exciting opportunity to promote the leadership skills and identity of the peer group. We believe the ongoing work of our lab is the design process for the 21st century and a necessary part of our future environment design for resiliency that doesn't break disciplinary silos, but instead makes them porous.

Bibliography

Books:

- Chong, Gordon H., Robert Brandt, and W. Mike Martin. 2010. *Design Informed: Driving Innovation with Evidence-Based Design*. 1 edition. Hoboken, N.J: Wiley.
- Cross, Nigel. 2011. *Design Thinking: Understanding How Designers Think and Work*. Oxford ; New York: Berg.
- Edwards, Andres R., and David W. Orr. 2005. *The Sustainability Revolution: Portrait of a Paradigm Shift*. New Society Publishers.

¹⁰ (Edwards and Orr 2005, 1)

¹¹ (Bruton 2010)

Reports:

- Mt Vernon Manor; Community. 2013. "Mantua! We Are Mantua! Choice Neighborhoods Initiative." http://planphilly.com/uploads/media_items/mantua-transformation-plan-1.original.pdf.
- Lerch, Daniel. 2015. "Six Foundations for Building Community Resilience." *Post Carbon Institute*. November. <http://www.postcarbon.org/publications/six-foundations-for-building-community-resilience-2/>.

Paper in journal:

- Bruton, Alex. 2010. "The Venture Design Studio: A Design Thinking Approach to Teaching and Learning for the Conception, Communication and Innovation of New Venture Concepts*." In *ICSB World Conference Proceedings*, 1–32. Washington, United States: International Council for Small business(ICSB). <http://search.proquest.com/docview/750434689/abstract/A1196B3E87E94761PQ/1>.
- Owen, Charles. 2008. "Design Thinking: On Its Nature and Use." <https://hbr.org/product/design-thinking-on-its-nature-and-use/an/ROT060-PDF-ENG>.
- Oxman, Neri. 2011. "Variable Property Rapid Prototyping." *Virtual and Physical Prototyping* 6 (1): 3–31. doi:10.1080/17452759.2011.558588.

Website:

- "An Introduction to Design For Equity." 2015. *DESIGN for EQUITY*. <http://www.designforequity.org/2/post/2015/02/part-one-an-introduction-to-design-for-equity.html>.
- "Definition of Biodesign | New Word Suggestion | Collins Dictionary." 2015. <https://www.collinsdictionary.com/us/submission/12064/Biodesign>.
- Neri Oxman Ted Talk. 2015. *Design at the Intersection of Technology and Biology*. TED talk. https://www.ted.com/talks/neri_oxman_design_at_the_intersection_of_technology_and_biology.
- "The Dornsife Center." 2016. *Dornsife Center for Neighborhood Partnerships*. <http://drexel.edu/dornsifecenter/>.

Mateusz Pankiewicz

Department of Digital Technologies in Architecture and Urban Planning,
Faculty of Civil Engineering, Architecture and Environmental Engineering,
Lodz University of Technology, Lodz, Poland

Understanding the meaning of architectural-urban heritage – review of approaches and methodologies?

Introduction

Since some time already, digital reconstructions in architecture, urbanism and archaeology are gradually switching from describing built heritage as a collection of static and unchangeable entities towards more compound and explicit presentation and knowledge management techniques. This includes for instance data management and multimedia systems, immersive environments or semantic information modelling such as GIS¹, BIM² or HBIM³. Graphical user interfaces, interaction and usability have become an essential part of produced reconstructions. This shift in terms of dissemination of an architectural and urban heritage that is supposed to increase the social awareness and participation should be structured in a way that enables recipients originating from different backgrounds to grasp information pertaining to almost any knowledge domain, allowing for self-exploration and interpretation of presented knowledge.

Context

Those tactics do take into consideration and slowly, but successfully, incorporate the incontestable fact that historical sites do have a rich and complex history, abundant with evolutions and changes, known by means of historic documentation – even if partially only. Though realising this invaluable feature of buildings means already a lot and appears to constitute an important milestone for digitalisation of built heritage.

The idea of change mentioned above should not be understood only in terms of topology of the heritage artefacts, but also in terms of their immateriality, namely of cause and effect factors that were influencing entities in the past, determining their present condition and appearance. There is a strong need to preserve space for hypotheses as well, as hardly any heritage unit is free of uncertainties emerging from, for instance, heterogeneous, dubious, incomplete or even contradictory historical documentation – if any in the first place. Furthermore urban, as well as architectural

¹ GIS – Geospatial Information Systems

² BIM – Building Information Modelling

³ HBIM – Historic Building Information Modelling

entities are never constant in time as they tend to undergo constant and unavoidable transformations of different types. These events in combination with other factors that may seem divergent or even unrelated at the first glimpse, shape and form the buildings or whole urban complexes through their lifespans. Moreover, the typological difference between architectural and urban entities, which results from the fact that the urban environment can be perceived as a container for multiple architectural components, awakes the awareness of different granularities⁴ – or scales – of aforementioned causative factors and events. Better or worse preserved remnants of architectural past encountered nowadays are therefore resultants of all these processes that had occurred. Entanglement of these factors can be eventually perceived as the construct of what could be called the meaning of the built artefact.

Bidirectionality

Nowadays advancing data-processing technologies allow for more comprehensive and massive data acquisition from heritage sites. These in turn become necessary in order to describe, understand and support built heritage. Acquired vast collection of data and information needs, though, a suitable, robust system – or environment – to store, manage and present its values. With progressive advancement of information technology more and more options are available for the researchers. Nevertheless it occurs to the author that it is currently possible to determine two particular directions in which the process of digitizing built heritage is heading. The foundation for this specific bidirectionality lays on the one hand in the development of BIM theory into practice which results – from a CAD⁵ point of view – in the release of dedicated specific software such as Autodesk Revit or Graphisoft Archicad, as well as proliferation of its assumptions through diverse groups of interests such as architects, archaeologists, historians – to name a few; and on the other hand in the need to search for and create custom solutions dedicated to particular problems or issues, which is strongly encouraged and motivated with the spread and popularisation of programming languages and highly advanced frameworks such as Unity 5 or Unreal 4 which from some time already are no longer reserved only for top-end professionals or AAA development studios. While both approaches are conceptually different they try to serve the same purpose: to gather, manage and disseminate the knowledge about built heritage.

Beginnings

Regardless of which approach is to be chosen finally, there are still some strategic decisions to make and steps to fulfil initially. This article aims to describe them in more detail. It highlights three main factors that are fundamental for the proper organization of such a complex multidimensional reconstruction model: addressing temporal issues, spatio-temporal representation of uncertainty in data, hypotheses and a spatial organization of the model to allow diverse usability.

⁴ Granularity is specified by an anchored point on the time axis and a partitioning length. The anchored point denotes where the partitioning begins while the partitioning length denotes the size of each granule. Different applications require different levels of granularity.

⁵ CAD – Computer Aided Design

Time for a change!

As it was already mentioned, every built entity changes during its lifespan. Number of possible transformations it could go through are vast, though it is possible to distinguish most relevant: buildings are built, destroyed, rebuilt, they may be extended, attached to another entity or divided into several parts. Eventually they can peacefully degrade through the whole life-cycle. Last but not least it can occur that the building would be totally or partially erased and rebuild in the same or different location (e.g. city of Warsaw after II World War). This statement makes apparent that whenever there is a change in space (spatial alteration) it never happens instantly but instead implies that some time passed from the beginning of transformation to its end. Undeniably time plays an important role in the description of change. Even more when we take into consideration that not only spatial form of the building is changing but also its relationship with surrounding entities or its particular attributes. Reassuring, the change can affect objects morphology, topology or attribute definition and it never lacks a temporal dimension. (Fig.01)

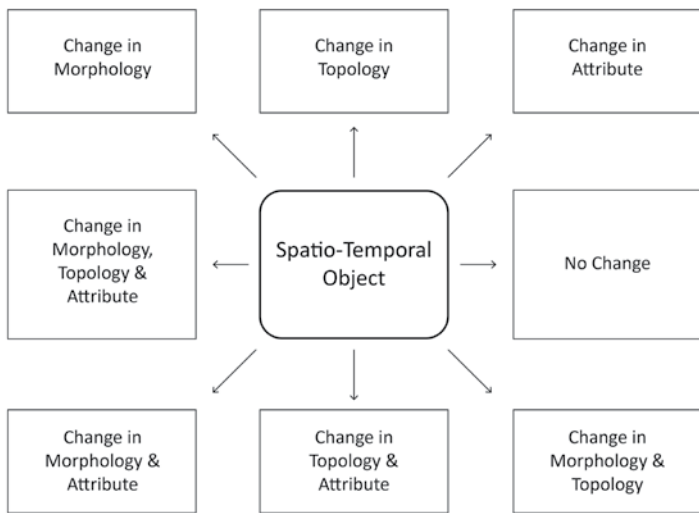
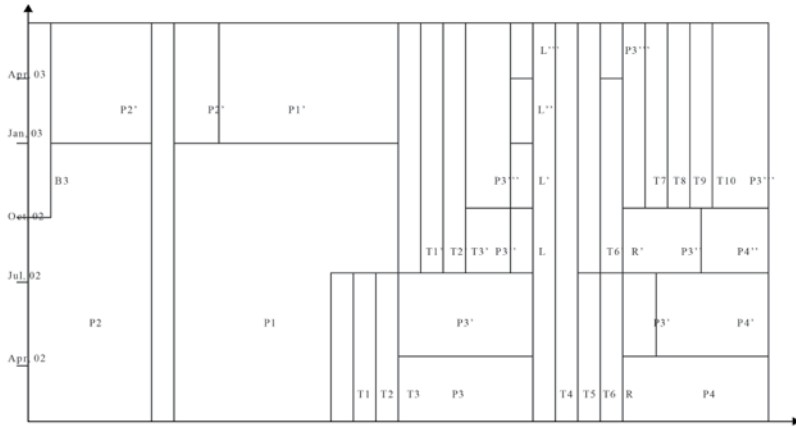

Fig. 01. Possible types of change of a spatio-temporal object
 Source: author

The time of each alteration is, as a matter of fact, never constant. Each type of change lasts different amount of time. For example the demolition of the building can take just a few days, while its construction could last for years or even decades. This implies that time of the event occurrence is therefore scalable., which means that temporal incidents have different granularities.

Such complex spatio-temporal transformation system occurring on different – usually nested – levels with various scales need a proper and suitable data management

A



B

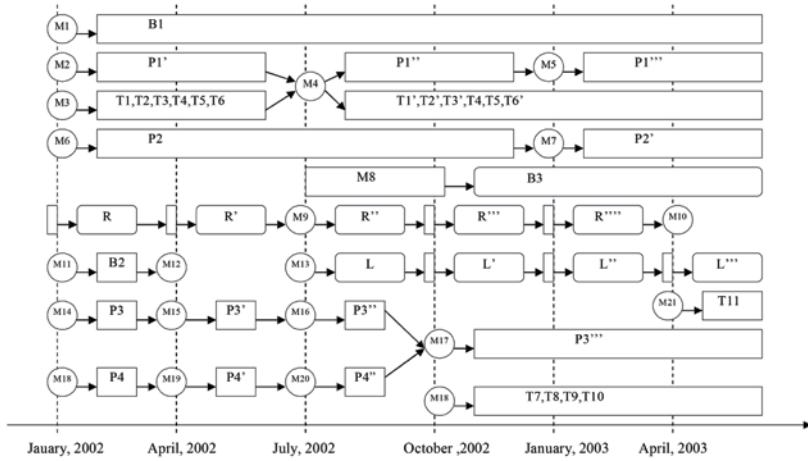

C

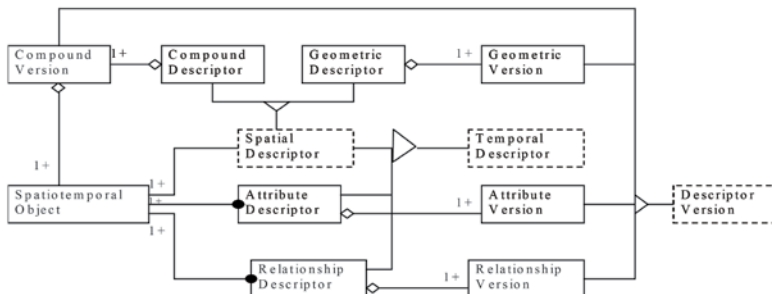

Fig. 02. Graphic approximation of exemplary spatio-temporal database models. A. Simple Time-Stamping, B. History Graph Model, C. The Spatio-Temporal Object Model (STOM)

Source: Pelekis, Nikos, et al. "Literature Review of Spatio-Temporal Database Models". *The Knowledge Engineering Review*. vol. 19, issue 3. 2004. p. 235-274

system. Pelekis⁶ describes and compares eleven ready-to-adopt database models with various levels of complexity, each accurate for certain tasks and aims. The question of which model to choose relies mostly on the defined goal of the undertaken reconstruction, its entanglement, query structure and operations it should be capable to perform simultaneously. Whereas some models are simple and operate on the snapshot or time-stamping based structure, others reflect quite elaborated mechanisms derived from graph theory or Object Oriented Programming (Fig.02).

What if...?

In the domain of digital heritage a lot of effort is put to create accurate and precise digital reconstruction models from available spatial data, preferably using Terrestrial Laser Scanning or photogrammetry techniques supported by historic documentation. Simultaneously it limits the scope of the reconstruction to the digitalisation of only what is left or, perchance, to particular states of the building to which available documentation does not arouse any level of uncertainty or suspicion. However, in the field of digital historic heritage, more than anywhere else, due to its unstable and long-term character, not only spatial, but temporal aspects need to be taken into consideration. Traces in form of historic documentation stored in archives (if there are any in the first place!) are rarely satisfying the researchers. Heterogeneous, dubious, incomplete or even contradictory documentation leaves many question marks and door open for hypothesis and introduces the thrill of uncertainty concerning spatial, as well as temporal aspects.

Spatial uncertainty results usually from lack of material on which the researcher could base his reconstruction. Historic sites were rarely, or never, surveyed in the past when no one would expect them to be historic one day. Most of the archived material consists usually of crude designs and drawings, but almost never of post-construction surveys. This makes researchers working with almost hypothetic source documentation, as the changes made on-site during construction of the building were, with the high level of probability, never marked or described. Researchers are usually left with pieces of information on which they are supposed to build their proverbial church. As it is impossible to find just one ideal solution that would describe changing building morphology it is crucial to refer to the hypothesis based on reliable sources not necessarily concerning particular entity but at least similar from the same time period.

Temporal uncertainty, on the other hand, is even more complex and can be described with several factors. First, and probably one of the most important, is the problem of dating exactness, which reminds instantly about time granularity. Events which took place “in XIXth century”, “in year 1845”, “between the year 1897 – 1909” denote different temporal weights. If the scale is the century – can we define precisely the year? Or if the scale is the year – are we able to define the month? This imprecisions in dating description causes lack of cohesion and presents first important

⁶ Pelekis, Nikos; Theodoulidis, Babis; Kopanakis, Ioannis; Theodoridis Yannis. “Literature Review of Spatio-Temporal Database Models”. *The Knowledge Engineering Review*. vol. 19, issue 3. 2004. p. 235-274.

technical problem as well. Another trouble arises with the interpretation of the heritage sites. Historians, art or architecture historians have the responsibility to interpret and explain the past on the basis of historic sources. This can undoubtedly lead to a formulation of various and divergent hypotheses concerning particular entity. As a result each formulated opinion is laden with some level of uncertainty, which in turn affects the entity and possibly distorts its spatio-temporal change pattern deviating it from unknown reality.

Structure

To entirely utilize the potential of building entities for the sake of performed reconstruction it is necessary to classify them in order to withdraw maximum spatial information from general data. It is possible to distinguish three phases of such ordination. First one assumes classification according to the adopted point of view - which means it is possible to distinguish elements according to their e.g. function or material they are composed of, as well as to other criteria such as time of erection or style they were built in, etc. Second differentiate elements according to their morphological decomposition in the life-cycle process. Eventually, in the third phase associations among concepts are created and visualized.

Working with historic structures requires constant reasoning about temporal changes. This in turn necessitates proper model structuring and reorganization which leads to the question of its morphology as well as its attributes and spatial relationships with surrounding entities.

Recalled earlier, the concept of granularity, has a strong influence not only in case of temporal dimension but spatial and structural as well. Each building undergoes changes, but each one is composed of many smaller elements which, as a matter of fact, also undergo change. Accordingly, this works in opposite direction: a building is just a part of a larger group of buildings which in turn construct a neighbourhood, district or town. Therefore it is possible to introduce various levels of spatial granularity as well. Defining this hierarchy is important, because every element or entity would have its own specific attributes, sometimes utterly unique, sometimes shared with others. In general it is possible to organize objects in three nested levels: 1) groups – agglomerating building complexes, single buildings and their major components; 2) entities – corresponding to the functional and temporal model divisions; 3) references – representing some specific aspects of extracted entities. This peculiar morphological inception could be than limited by setting the minimum and maximum level of detail that seems sufficient for the purpose of performed reconstruction.

Conclusion

Initial assumption for this paper was to provide a comprehensive review of methodologies and approaches used in the process of architectural-urban heritage digitalization. During the research though, it has become clear to the author that it is really hard to distinguish specific methodologies to proceed with a general idea of performing architectural-urban heritage reconstruction. Research showed nevertheless, that particular problems are repetitive and common for analysed case-studies. These, in

turn create almost a pattern to follow. Spatio-temporal data management, insufficient sources that provoke and fuel uncertainties related to spatial, temporal, as well as attribute layers, handling of existing hypotheses are mostly reported. This article provided the description of the aforementioned and tried to provide prototypical guidelines for handling such cases in the future.

The aim of this article is also to start a wider discussion about immersive spatio-temporal digital heritage reconstructions, where word ‘immersive’ should be perceived not only as referring to technology but also as composed in such a way to allow collection and management of the variety of data and datatypes for analytical and synthetic purposes, which eventually would allow users originating from different scientific backgrounds to participate in the past, present and future life-cycle of the built heritage entity.

Bibliography

Paper in journal:

- Pelekis, Nikos; Theodoulidis, Babis; Kopanakis, Ioannis; Theodoridis Yannis. “Literature Review of Spatio-Temporal Database Models”. *The Knowledge Engineering Review*. vol. 19, issue 3. 2004. p. 235-274.
- Dudek, Iwona; Blaise, Jean-Yves. “From artefact representation to information visualisation: Genesis of informative modelling”. *Smart Graphics*. vol. 3638 of *Lecture Notes in Computer Science*. 2005. p. 230-236.
- Anderson, Eike Falk; McLoughlin, Leigh; Liarokapis, Fotis; Peters, Christopher; Petridis, Panagiotis; de Freitas, Sara. “Developing serious games for cultural heritage: state-of-the-art review”. *Virtual Reality*. issue 10. 2010. p. 255-275.
- Stefani, Chiara, De Luca, Livio, Véron, Philippe, Florenzano, Michael. “Time indeterminacy and spatio-temporal building transformations: an approach for architectural heritage understanding”. *International Journal on Interactive Design and Manufacturing (IJIDeM)*. vol. 4. issue 1. 2010. p. 61-74.
- De Luca, Livio, Busayarat, Chawee., Stefani, Chiara, Véron, Philippe, Florenzano, Michael. “A semantic-based platform for the digital analysis of architectural heritage”. *Computers & Graphics*. vol. 35. issue 2. 2011. p. 227-241.
- Murphy, Maurice; MCGovern, Eugene; Pavia, S. “Historic building information modelling (HBIM)”. *ISPRS Journal of Photogrammetry and Remote Sensing*. no. 76. 2013. p. 89-102.

Paper in book with editor:

- Fai, Stephen, Graham, Katie, Duckworth, Todd, Wood, Neville, Attar, Ramtin. “Building Information Modelling and Heritage Documentation” in: Pavelka, Karol (eds.). *XXIIIrd International CIPA Symposium*. Prague: XXIIIrd International CIPA Symposium. 2011.
- Garagnani Simone. “Building Information Modelling and real world knowledge.

A methodological approach to accurate semantic documentation of the built environment” in: Addison, Alonzo C. & Guidi, Gabriele & De Luca, Livio & Pescarin, Sofia (eds.). *Digital Heritage*. Marseille: Digital Heritage International Congress. 2013. p. 489-496.

Tamborrino, Rosa, Rinaudo, Fulvio. “Digital Urban History As An Interpretation Key Of Cities’ Cultural Heritage” in: Guidi, Gabriele & Scopigno, Roberto & Torres, Juan Carlos & Graf, Holger (eds.). *Digital Heritage*. Granada: Digital Heritage International Congress. 2015. p. 235-242.

Di Mascio, Danilo, Chiuni, Michele, Fillwalk, John, Pauwels, Pieter. “3D Digital Reconstruction of Lost Buildings” in: Herenoja, Aulikki & Österlund, Toni & Markkanen Piia (eds.). *Complexity and Simplicity*. Oulu: ECAADE. 2016. p. 511-520.

Other:

Renolen, Agnar. “Modelling spatiotemporal information: The spatiotemporal object model. *Technical report. Department of Surveying and Mapping (IKO)*, The Norwegian Institute of Technology. 1997

Kimberly, Dylla; Frischer, Bernard; et al. “Rome Reborn 2.0: A Case Study of Virtual City Reconstruction Using Procedural Modeling Techniques,” in: CAA 2009. Making History Interactive. 37th Proceedings of the CAA Conference March 22-26, 2009, Williamsburg, Virginia. Archaeopress: Oxford, 2010. p.62-66.

A step in the past, a look into the future: the poetic of black and white to decode Italian rationalist architecture

Introduction

The power of photography is undeniable. Various focal length lenses and the use of artificial light provide for an edited reality. In architectural photography, undesirable context can be easily blocked out, detailed enhanced, interiors brightened or temporarily refurbished to portray a utopian spotless living rather than the one entertained by its real occupants. Notwithstanding manipulation of space, time, and meaning, photography, unlike any other visual media, captures the moment. It records the present, which is an ephemeral concept, as we live almost simultaneously in the past and in the future.

Sharp, crisp, color photographs are the medium of choice in supporting the description of buildings in architectural history courses. But should they?

Forward

In recent times while preparing a new elective course on modern architecture in Italy during the interbellum, I was faced with such dilemma. Contemporary imageries of buildings built around 80 years ago, I reasoned, albeit depicting the buildings in their present state, would alienate the students' from accurately engaging and understanding those forces, philosophical, environmental, and political, that unmistakably had influenced the design solutions. In many cases, time had drastically changed the context of those buildings I planned to disclose providing for an environment quite diverse than the one the architects of that time were faced with and responded to. Italian Rationalist architects fervently sustained that their architecture unambiguously rose from the surrounding context and Italian traditions. It became apparent to me that the sole and truly honest way to exhibit the(ir) architecture in its original milieu would have been by using photographs taken during that time. The deliberated choice of using black and white photographs prompted the creation of a supportive graphic language of similar visual vocabulary aimed not only at giving the course its own and unmistakable identity, but also to provide for a research platform testing how original, engaging, and at times, provocative graphics could help students retaining complex topics or succession of events.

Process and Methodology

In the preface to their book, *Graphic design: un linguaggio*, d&d comunicazione states that if language is made up of signs, of conventional elements variously combined to enable completeness of expression, then it seems logic to define graphic design in this terms, “a language made up of signs that [...] knows how to speak to people looking [...].”

A few years back as part of an exploration in visual communication developed in conjunction with my research practice, I developed a short portfolio exploring the absence of color. By that time, we had created various identities for mostly small design firms, architecture and landscape architecture in particular, whose marketing budgets were limited. Working in one or two colors to reduce printing cost became the norm. Obviously, using a limited palette of pigments was not a novel idea. Who does not remember when newspapers were printed using solely black ink? Limiting the amount of color is, of course, not a limitation on what can be created, quite the contrary. “Stripping away color,” writes Lesa Sawahata in the preface of the book *Black + White and Two Color Design*, demands “stronger elements from the designer. Type, images, illustrations, and headings all gain more importance and must be conceptually cohesive.”

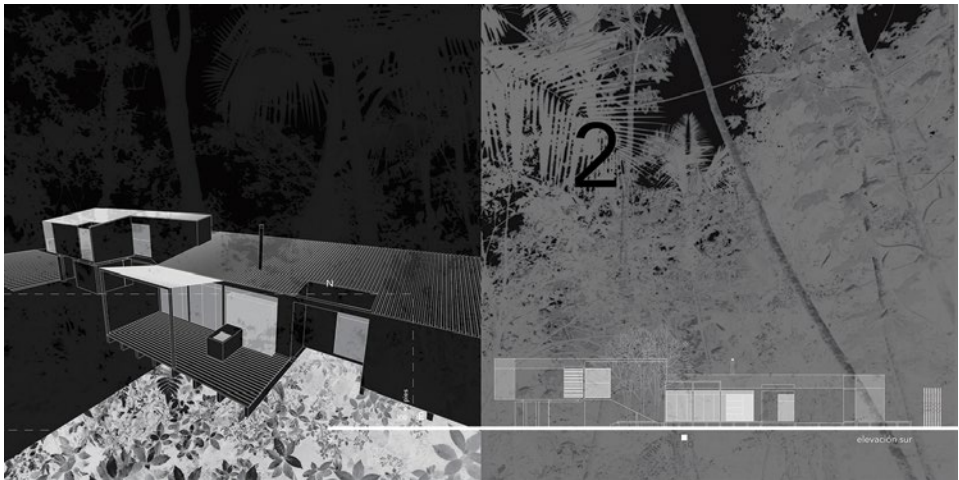

Fig. 01. Monochrome explorations as part of a design portfolio study.

Source: Paolo Sanza

To continue the monochrome explorations in the classroom environment, tempting was the manipulation of period photographs, instigated in part by having set a(n atypical) 16:9 ratio for the slide presentation in contrast of the common aspect ratio of 3:2 found in analog photography, and the relatively low resolution of the period images on hand. But in the context of the course, a heavy handed artistic manipulation, even if visually engaging, would have been inappropriate.

The period black and white photographs selected to exhibit the architecture and other salient, but complementary events of 1920s, 1930s, and early 1940s Italy, were the technological expression of a time now long gone; yet in contemporary times,

black and white photography represents a deliberate manipulation of reality to create art and let individual imagination color it. Could any alteration of period photographs retain the photograph's original historical flavor while simultaneously project a contemporary artistic sense? It was a challenge I could not resist. The solution came as a fortunate stroke of serendipity. Having lost most of the resolution of many of the period images at hand after these were stretched to achieve the desired 16:9 ratio, a combination of simple digital manipulations to regain at least partial sharpness, led the image to assume a silver glow. The image so created retained the essence of the original photograph, but projected a distinct emotional personality and an unmistakable contemporary feel.

The dive into past landscapes was further made possible by screening period video clips. Instituted in 1924 by Benito Mussolini, the Istituto Luce, aside from promoting cinematography, became a powerful propaganda agency for the fascist regime filming thousands of events, including the construction and inauguration of innumerable public and private works. Restored, but not altered, the video clips were all narrated in Italian, a language my students could not comprehend. But were these voices of men and women of a time long gone that further projected students to the dynamics of the time.

Having set the period black and white photographs and the video clips as the backbone of the course stimulated in me a further interest. Could the course be branded?

The online business dictionary defines branding as “the process involved in creating a unique name and image for a product in the consumer’s mind, mainly through advertising campaigns with a consistent theme.” If the photographs and the video clips were the constant themes, they were not, I rationalized, enough to brand the course. Any successful branding development with or without the aid of still photography must encompass a unique typography strategy. A stunning image can unequivocally lose its power if complemented by a not sympathetic typesetting. With the advance of desktop publishing, its affordability and ease to learn, we have witnessed an exponential rise of bland, ugly, and at times, repulsive, graphic work most often generated by people lacking a design background or the mere design sensibility. Even for experienced designers, it is easy to fall, in the words of Rob Carter, in the “pitfalls posed by typographic tricks in software packages.”

Simple forms composed majestically, sophisticated treatments of natural light, absence of superfluous or insincere decorative elements, applications of the latest construction techniques, and high philosophical principles characterized the architecture I intend to exhibit. If any text were to accompany the photographic journey, it had to be designed in such a way to contribute positively to the creation of the “brand,” as well as be an integral part of the learning experience.

Having for years utilized a non-mainstream font family to write my classes’ syllabi and project statements, while gaining from the students’ body an unexpected and certainly unsought “trademark,” it became natural to utilize the same font family for any typographic work I was set to produce for the course. Keeping with the black and white character of the period photographs, all text was white on a black background.

A step in the past, a look into the future: the poetic of black and white to decode...

The text layout took inspiration once again from the explorations done in conjunction with my professional practice. On those studies, I intended to challenge the convention of placing text in columns separated by gutters, while retaining readability.

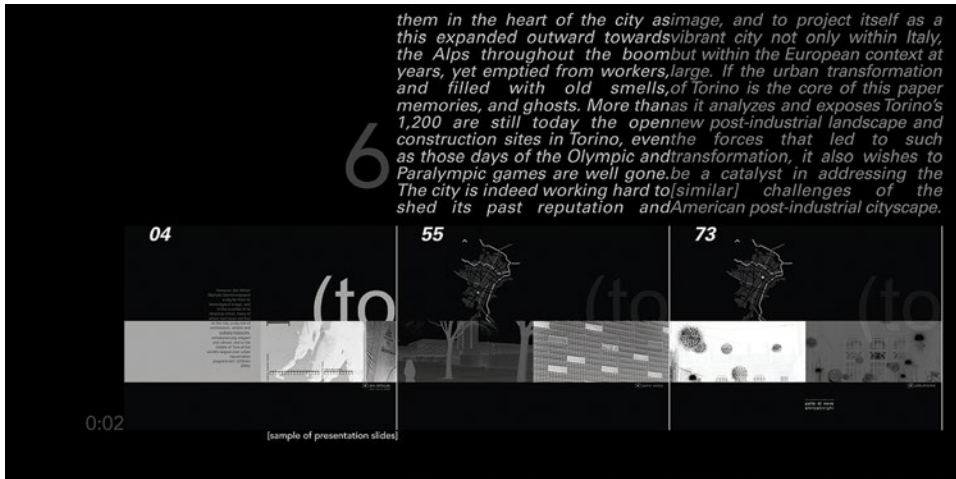

Fig. 02. Typography explorations as part of a design portfolio study.

Source: Paolo Sanza

For the design of those course slides containing a large amount of text, I opted for a straightforward four-column text layout where each column was separated by a gutter. However, to give the page a distinctive visual appeal and contribute positively in capturing students' interest in the writing, I infused the text with simple rules. To highlight the hierarchy of the information, the font was modified by either increasing its sizes, using boldface or italics, or a combination of. These, of course, are standard graphic techniques that respond to the human eyes receptiveness to visual differences. What I further added was a text that blended with the black background. This was the text that was in line to be read and discussed, one that I purposely did not manipulate to express any form of hierarchy, as this would only be revealed when the text reached its discussion time. My intention in doing so was to give the sequence of static slides a cinematographic expression, and once more, test the learning receptiveness of the students.

Various other typographic solutions were presented throughout the course, some with the intent to sublimely inspire in architecture students more complex graphic solutions for their presentation boards.



Fig. 03. & Fig. 04. Sample of typography adopted in the course's slides.

Source: Paolo Sanza

Notwithstanding the research aim to portray all the course's information in black and white, it came evident, after pursuing several studies, that to clearly convey some of the material, I needed to utilize some color. The choice fell to a small palette consisting of cyan, and custom “blend” yellow, red, blue, and green. To each color, I assigned, for the most, the “task” of portraying information throughout the semester that even if diverse, fell into the same category. Cyan, for instance, represented quantifiable information, such as years, which in turn could either represent age or the time passed since a particular event. After a handful of lectures, students could relate to the information represented by the colors and came to quickly identify it regardless on how often it appeared during the length of the course.

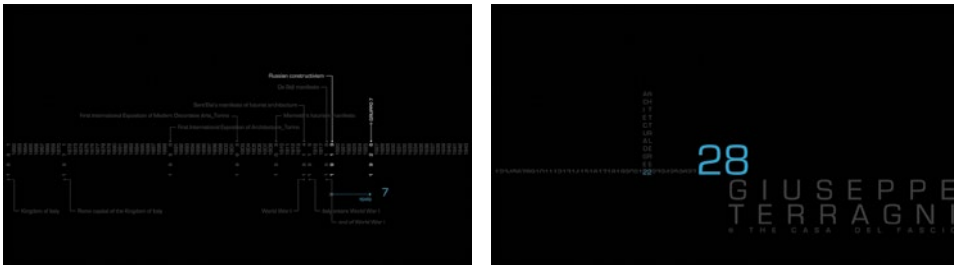

Fig. 05 & Fig. 06. Sample of how color was introduced in the black and white text.

Source: Paolo Sanza

The passage from lightly tweaking the text to create full-fledged infographics was natural. As the data acquired “volume,” it became necessary to present the information in a more comprehensive way. Paramount for me, as the complementary graphic language was taking form, was incorporating in the work as much as possible those “rules” I established for the colored text and give a consistent interpretative language to the course.

A step in the past, a look into the future: the poetic of black and white to decode...



Fig. 07. & Fig. 08. Sample of infographics
Source: Paolo Sanza

The primarily objective of the course was to introduce students to modern Italian architecture of the 1909 – 1943 period, with a strong emphasis on the one devised during the interbellum period. Collaterally, the course aimed to expose students to a brief history of Italy as I viewed this step important to comprehend, the forces that led Italy to be administered starting in the early 1920s by, paraphrasing Terry Kirk, a government that like no other else in the west world supported modern architecture so fervently.

To exhibit the chronological order of historical events, I opted to maintain the same graphic language developed to narrate the architecture, but with a simple, yet effective twist that would identify the “two chapters” of the course. Instead of of the black background that characterized the architecture chapter, the history chapter presented a white background and images in color. Rules governing any text remained the same.

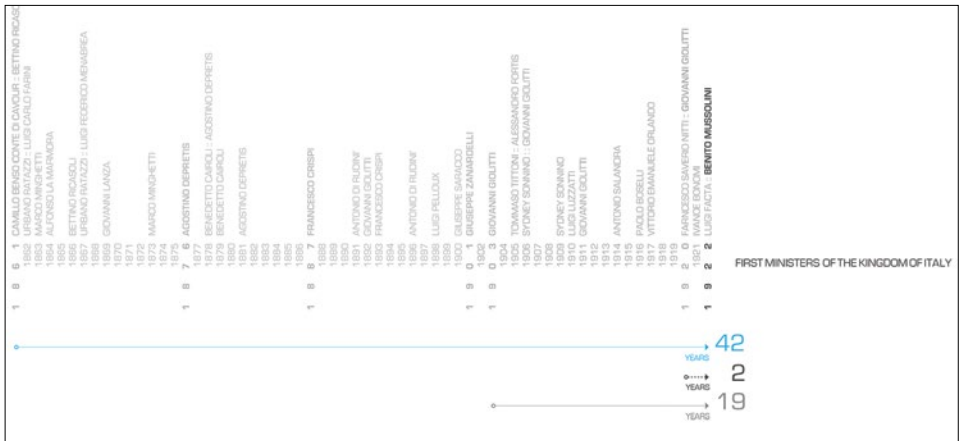

Fig. 09. Sample of the graphic language used in the history chapter of the course
Source: Paolo Sanza

Since the course’s gestational phase, I also aspired to give the course a non-linear structure and a multidimensional character, one able to ingeniously exhibit the architecture in question as well as opening a window to those episodes that undeniably impacted the formation of Italian contemporary architecture and design, being these

political, academic, speculative, scientific, or entrepreneurial.

The outcome of WWII left Italian architects in precarious conditions. The fortune of most of them came about because of the strong emphasis that the fascist government had placed in construction, a policy unmatched by any other Western state of the time, which made of Mussolini's Italy the largest support of modern architecture. The collapse of the fascist regime displaced them. Some, as is the case of Luigi Moretti, even experienced brief imprisonment because of their collaboration with the fascist regime. Others, like Angiolo Mazzoni, preferred voluntary exile rather than dismiss a fascist past. However, after the chaotic time that followed the end of the war, they resurfaced. Rationalism principles were not completely abandoned but rather used as the catapult for exploring organic forms, as illustrated by the work of Giovanni Michelucci, or parametric design, pioneered by Moretti. Moretti had initiated exploring mathematically driven architecture forms already in the 30s, but it was only in 1960 that he presented at the XII Milan Triennial the design of a parametric stadium whose form derived from nineteen parameters concerning things like viewing angles and the cost of concrete. These and other episodes were included in the course generating what I call *time vortex(es)*, views to a reality yet to come. The time vortexes were not limited to unveil the lifetime achievement and contribution of selected architects to Italian architecture or design, as in the case of Gio Ponti, but also to present unique entrepreneurial cases that rose during the 30s and mature in the years that followed the end of WWII to eventually influence recently founded enterprises. Case in point is Olivetti, the small town typewriter company that, despite having factories across the globe and international fame, never felt compelled to move its headquarters from Ivrea to nearby Turin or Milan, and the inspiration, we can argue, of Steve Job's Apple Computers. Olivetti's holistic approach to design embracing architecture, urban design, industrial design, graphic design, and social sciences were extensively presented and documented in the lectures.

Introducing topics of a time to happen did justify creating a new visual vocabulary? Would continue using black and white photographs make rational sense when those buildings were mainly photographed in color? What about the Olivetti advertising campaign I intended to share? Would the posters endure the same effect if deprived of those colors that made them so unique, elegant, and beautiful? I came to the conclusion that if I was to brand the course, the overall visual communication of any information presented had to support the brand. The vertical vortexes, therefore, showed a distinctive graphic language in line with the strategy I adopted for the history chapter of the course, but coherent with the brand, and easily recognizable by the students.

Conclusion

Over 3,000 slides encompassed the course, 25% of which were original graphics and infographics I purposely designed. In the end, the lectures became chapters of a visual book built upon intuition and effort, perseverance and obsession.

Academia is that rare working environment where as you teach you learn, explore, test. The occasion of preparing a new course offered me the unique opportunity to test alternative delivery methodologies, cultivate my interest in complementary design fields, feed my imagination, and expand my knowledge.

The course outcome represented my passionate effort to create a distinctive, mindful, and, at times, even exceptional, learning environment. Students voiced their fondness of the material presented in the course's evaluation with comments such as "*Impressive presentation of lectures,*" "*Very interesting information presented in a very beautiful way. Very thoughtful presentations,*" or "*The presentation of the material is absolutely beautiful. Just in the presentation I found inspiration for my work. Never have I loved and appreciated architecture so much.*"

The course's fourth season is fast approaching. The poetic of a black and white environment will endure. But technology is knocking at the door with tempting new "toys" that speak the Generation Z's language. After including this past fall video images captured by drones, navigating the masterpieces of Terragni, Figini & Pollini, or Calza Bini in virtual reality tours may be my next *big* thing.

Bibliography

Books:

Bucci, Federico. *Luigi Moretti: Works and Writings*, New York: Princeton Architectural Press, 1980.

Carter, Rob. *Working With Computer Type 2*, Mies: RotoVision SA, 1996.

Kirk, Terri. *The Architecture of Modern Italy (Volume II: Visions of Utopia, 1900-Present)*, New York: Princeton Architectural Press, 2005.

Sawahata, Lesa. *Black + White and Two Color Design*, Cincinnati: Rockport Publishers, 1999.

Website:

<http://businessdictionary.com/> (accessed 14.05.2017).

360° vision, from panoramas to VR

Introduction

With a £5 Google Cardboard and a cell phone, everyone can live a 360° immersive experience. Youtube provides a huge amount of content, professional or private. Blockbusters like Starwars, groups like Gorillaz post their latest film in 360 Vr format to literally plunge the audience into their worlds of images and sounds. 360° photos are now accessible with a single click at a reasonable price. In museums like Stonehenge or Museums Victoria in Melbourne, cylinder screens offer a collective experience, with a one to one scaled image.

What seems to be a state of the art technology is in fact 230 years old. Everything started in 1787 in Edinburgh when Robert Barker (1739/1806) painted the first panorama. Barker did not just invent the 360° image, but also the scenography that makes the illusion perfect. The first patent was granted by American engineer Robert Fulton (1765/1815) in 1799¹. It refers to “a circular picture without boundaries” but also describes the architecture, the position of the viewers, the way to get in and out. Between the end of the 18th century and the beginning of the 20th, panoramas were very successful and huge buildings were made such as the London Colosseum built in 1827 or the Hittorff’s “*Rotonde des panoramas pour les Champs-Élysées*” in 1842. The London Colosseum was also stated as a landmark and a belvedere.

It is a common thought that cinema killed panoramas. It is partially true. At the dawn of the 20th century, most panoramas closed, were destroyed or transformed. The memory of their greatness faded away. A very few remained until a late rebirth with digital techniques. But in fact, the idea of an immersive panoramic view has still being developed and improve over time. The Oculus Rift or HTC Vive can be considered of the heirs of panoramas. In the article, we will follow those evolutions and transformations from panoramas to VR.

Two legacies: landscape painting and theatre.

Barker’s panorama is a milestone in the history of representation and is the synthesis of two important evolutions: landscape painting and renaissance theatre. In painting, the landscape went from background to the main subject mainly with

¹ Philip, Cynthia, *Robert Fulton: A Biography*, iUniverse, 2003

what is now called the Dutch Golden Age (17th century). Painters like Jan van Goyen introduced the “*tonal*” style picturing wide cloudy skies, windy atmosphere, and contrasted lights. The first Dutch paintings were quite small, but canvas became wider and wider when entering the 18th then the 19th century. Besides the artistic exploration of the landscape, started in France a topographic investigation with the Cassini family. Panoramic views were then tested with topography to give a synoptic representation of a map and the landscape around. Horace Benedict de Saussure drew a circular view from the summit of the Glacier de Buet in 1776 with a map in the middle. This image foreshadows the so-called “*little planet*” that we do now with a 360 camera. Panoramic views were also used for military purposes, very much like a 3D map. In 1915, Henry Valensy drew the panorama of the Dardanelles in two versions, a water coloured and inked version with comments. The two maps, used together, strongly recall digital maps services that we are using nowadays with a coloured satellite view and a raster view with texts.



Fig. 01. Panorama section

Source: Laurent Lescop

The second evolution came with theatre. The renaissance theatre is designed for a focused view toward the stage. The illusion of a vaster space is created by the perspective and the combination of layers with real objects in the foreground and painted scenery in the background. In the 19th century, many novelties will push creators to break this system: the photography, the lighting devices (using gas then electricity), the belvedere as a 360° point of view and new tricks to mimic reality. Swiss architect Adolphe Appia (1862/1928) revolutionised scenography by bringing new concepts to scene design and stage lighting. For him, space is not necessarily defined by an orthonormal basis for a homogeneous space but can also be thought as a lightscape. This breakthrough opened new concepts such as the “Total Theatre” (1925) led by Walter Gropius (1883/1969).

As well as for painting or theatre, the question moved from the illusion of a three-D image to the illusion to be *in* the image. Hans Belting (1935-) explains that the way we understand the three-dimensional space is purely occidental and when the first explorers arrived in Japan and showed Japanese our perspective images, those images were recognised as flat sculptures. It is because Japanese were looking their images

lying on a table as we look ours hung on walls. For Japanese, those hung pictures are *kubomi-e*: hollow concave picture. Both perspective images and renaissance theatre use the same principles to describe a narrative space: first, a perspective which constraints the position of the viewer and the direction of the look. Second, is what Josef Svoboda (1920/2002) called the watershed, meaning an invisible frontier between fiction and reality. For paintings, this watershed is bordered by the frame, the image is being considered as a window. In theatre, the watershed is the limit of the stage.

To bring the best illusion of immersion, panoramas will try to break those two principles. By offering a 360 circular picture, it will not possible to focus on one direction, the look will fly from one point to another, the body will be forced to move, to turn round. By adding a “*faux terrain*” between the circular image and the viewer, the watershed will be blurred. It will be difficult to know precisely if the spectator is already in the narrative space or very close to it, but outside.

An architecture of illusion

Most comments on panoramas focus on the image. But the illusion of being immersed is based on the design of the building, the way to get in, to discover the circular image and to get back to reality. We’ve got a very nice description of the program in Bapst’s “*Essai sur l’Histoire des panoramas et de dioramas*” (1891). Germain Bapst (1853/1921) is a member of many committees in the fields of art applied to industry. His essay is a very detailed description of a regular panorama where he emphasise the issues of the structure, the light and the how the public will experiment the illusion. He indicates that the spectator, placed in the centre of the structure, should be able to see the painting wherever he could look. It is also important that no real objects should be seen in order to make comparisons in terms of nature or scale of the painted image. Bapst also specifies that with a 15m high image, the natural light hits the upper part of the painting giving a more natural effect.

We also have a very detailed description by Hittorff, the master of panoramas in the 19th century. Jacques Ignace Hittorff (1792/1867) is a French architect renown for the construction of the Gare du Nord and the Cirque d’Hiver (“Winter Circus”) in Paris. Hittorff gave a very detailed depiction of a panorama in his essay called: “*Description de la Rotonde des panoramas élevée dans les Champs-Élysées*” (1842). The architect gives 5 imperative rules to obtain good results: the access has to be a dark corridor, mysteriously leading to the central part of the rotunda. The platform should reveal the entire circular image. The cone of vision should be 43°, for the reason that, according to Hittorff, it corresponds to the natural vision. A drop ceiling system channels the look. Last rule, a *faux-terrain* creates a connection and a visual continuity from the platform to the image.

As the circular painting is naturally lit, the size, position, and structure of the opening are very important. Hittorff indicates that in London, as glasses are not frosted, the structure of the roof shadows the painting, the illusion is not perfect. Another problem with natural light is the colorimetry. Blue skies provide powerful cold tints but reduce the impact of warm tonalities, colour intensity ratios cannot be preserved.

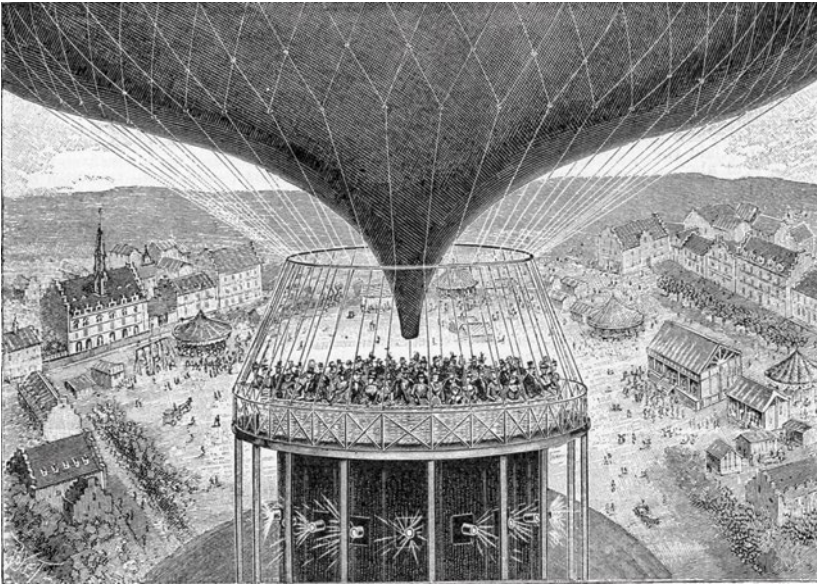

Fig. 02. The Cinéorama at the Exposition Universelle de Paris in 1900.

Source: *Scientific American* September 1st 1900

Technics of illusion

Many improvements were added to panoramas. The platform previously designed as a balcony then became a real ship's deck for the "Vengeur" panorama in 1892. As soon as photography was invented, it was seized by the panorama. The Lumiere brothers (Auguste 1862/1954, Louis 1864/1948) granted a patent for 360° photo on a single plate in 1900. The panoramic camera is called Periphote and the projector Photorama. The device allows projecting a 6m high image! The same year, Raoul Grimoin—Sanson (1860/1941) imagined a virtual balloon ride the Cineorama. Ten simultaneous projectors created a 360 moving image of an ascension while the public stood in a basket. Despite a very promising and spectacular invention, the attraction had to close because of fire issues. The 1900 International Exhibition in Paris saw many panoramas and two other impressive immersive attractions: the Hugo d'Alesi's Mareorama simulated a cruise on a huge ship. Two paintings of 750m long and 13m high each depicted the landscape and the story line. The trans-Siberian panorama suggested sitting in a real waggon mimicking the movement of a real moving train. Pictures painted by P. Piassetkiy gave the illusion of travelling through the beautiful Siberian landscape.

The next attempt to creating an immersive cinema screen came Abel Gance's *Napoleon*, created in 1927. This film actually contains only a single sequence projected onto three screens. It has been abandoned due to the difficulty to synchronise the three screens. Then Disney in its amusement parks recreated a kind of rotunda for a 360 vision experience: the Circarama. The Polyvision system, developed by Emile Vuillermoz relying on the 4:1 "format", then again, proved too complicated to put

into place and maintain. Once more it was finally abandoned. Several multi—screen projects were developed like the Vitarama (1939, eleven cameras), the Cinerama (1952, three cameras), the Circlorama (1958, eleven cameras), the Hexiplex (1992, six cameras). Much more can be listed, none of them really did a breakthrough.

An important point is the addition of the sound, of movements, light effects, sometimes even wind and smells as is the case for the Mareorama. Why? In cinema, everything outside the frame is imagined by the audience. The narration is a game where the author gives partial elements and let the spectator imagining the missing parts. The sound helps to complete the world that is depicted. In a panoramic image, there is no off-screen, everything is visible from a certain position. Some say sometimes that there is no point of view. But this is not correct. It is obviously a dominating spot for a synoptic view, a god's view. As long as the image remains flat, the watershed is not visually crossed. Sounds smells, the wind brings the illusion that part of the body is already in the narrative world.

The three movements of immersion.

We saw with those seminal examples that immersion the result of an arrangement and a device. The arrangement refers to the architecture and the scenography and the device is the technology used to create the illusion. The immersion is the feeling of being in the narrative space. Panoramas and then Gropius' *Total Theater*, followed 50 years later by Poliéri with a project like the "*Théâtre du Mouvement Total*" in Osaka, Japan in 1970, try to rip the spectator out of his world to dive him into a fictional world. Today, with digital technics, it seems easier to fool the spectator with a realistic 3D image, a 3D sound, and haptic devices. If it's true it's not that only.

We can describe immersion with three interrelating modalities: envelopment, saturation, and participation.

Envelopment

We saw that Barker invented the first panorama with this idea of literally wrapping the spectator into a unique image conferring the illusion of being on a belvedere. Louis-Jacques Mandé Daguerre (1787/1851) adds light and sound effects and earn enough money to develop his personal project: the photography. But it won't be Daguerre who will replace the panoramic painting with photographs. This step is made by Joseph-Philibert Girault de Prangey (1804/1892) with a view of Rome in 1842. One the first digital device is the *Hemispherium* (1999) but we can suspect the army or Nasa to have their own. The envelopment is improved by replacing a cylinder by a hemisphere. The *Satosphère* or *Sensorium* is one of the state of the art system to provide a fully immersive experience.

Saturation

Envelopment with image and sound may not be enough as it may be needed to focalise all spectator's attention. In fact, the best would to be stunned, when all senses are overwhelmed by the perceptual influx. In that case, the immersion a total because no exterior sensorial information can reach the spectator. It's what is expected in funfair

parks or even in cinema with a wide picture and a very loud sound. In 1961, Morton Heilig (1926/1997) granted a patent for a *Sensorama*, an immersive device with 3D wide vision, motion, colour, stereo sound, aromas, wind, and vibrations. Enclosed in the cabin, the user is totally isolated from the exterior world and his sensory system fully solicited by the device. Heilig has been rediscovered as a precursor of many actual devices. For instance, the “Stereoscopic-Television Apparatus For Individual Use” (1960) seems to be a mock-up of the Oculus Rift. Less technological, but no less impressive, we could consider that James Turrell’s perceptual cells also saturate our perception with a full coloured universe.

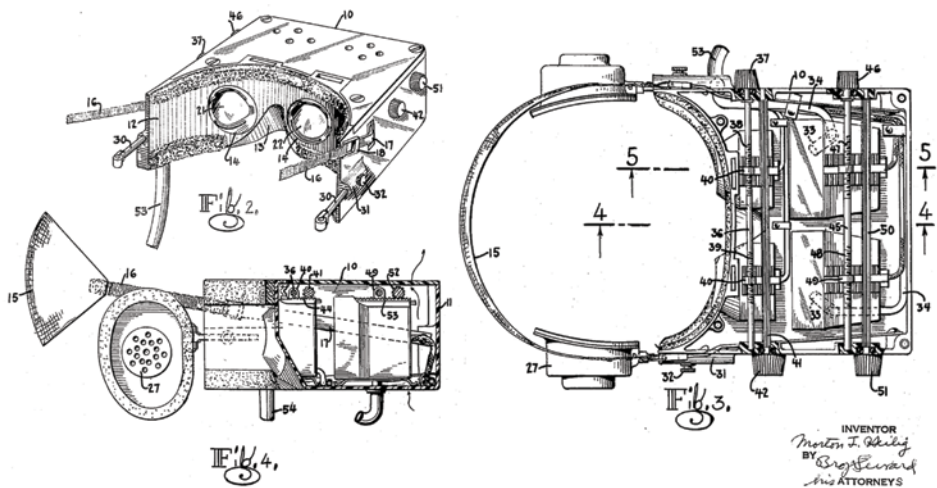

Fig. 03. Morton Heilig, Telesphere Mask, 1960,

Source: Wikimedia Commons

Participation

Interacting is the best way to believe that the watershed has been traversed. Interacting with a narrative world give the feeling that we are part of it. That is what happens in video games for instance. A gaming peripheral as body prosthesis to listen and talk, fill vibrations, activate or move; until now, a very few peripheral exist to smell or to touch. In professional simulators, to train pilots or surgeons, the entire environment is recreated in order to facilitate the immersion.

More interesting are the alternate reality game where the narrative world is the real world. In early 2000, a 3D virtual universe like “Second Life” (Linden Lab 1999-2003) appeared to be the paragon of immersion. In 2007, despite a huge buzz, Second Life, version one or two, lost any interest on earth, virtual spaces are so empty that, there are some virtual explorations of that deserted world. Now the real immersion is in our reality. With a smartphone and a specific app, it’s very easy to track a hidden world only visible through the screen. In “*Occupation Forces*”, it has been possible to see clandestine aliens in Boston. In 2013 a game goes further. All cities are a battleground opposing the Enlightened or the Resistance in Ingress (*Niantic Labs, 2013*) which is a

“location-based, augmented reality mobile game”. With the same technology, Niantic published a bit later “*Endgame: Proving Ground*” and then achieve the big hit with Pokémon GO in 2015.

In Pokémon GO the players must catch virtual creatures revealed in augmented reality through a smartphone. This innocent quest transformed the reality. Many places are now forbidden to the gamers, inattentive driving is now detected by the game warning the players. Massive gathering in some location transform neighbourhoods’ life and rhythm. Forbidden or secret places become suddenly famous and populated.



Fig. 04. virtual panoramas

Source: Laurent Lescop

AR, VR, virtual panoramas

Two competing technologies are now on the market. AR, Augmented Reality and VR, Virtual Reality. AR appears to be more promising. Even with a massive advertising, VR projects hardly find users and clients: basic equipment remains expensive, as it’s not a mask, but a powerful computer, joypads and a large spare place for the HTC Vive. Virtual reality sickness is also one big issue. In the end, major success comes with the Samsung Gear VR or the Google cardboard. In those systems, a regular telephone powers the applications, it is light, costless and easy to use, but, it has no tracking system. It means that the virtual image won’t follow the user’s moves. In the end, explorations are made from rotating chairs, discovering virtual panoramas.

Bibliography

Books:

- Bapst Germain. *Essai sur l'histoire des panoramas et de dioramas*. Imprimerie nationale (Paris). 1891
- Belting Hans. *Florence and Baghdad: Renaissance Art and Arab Science*. Harvard University Press. 2011
- Hittorff Jacques Ignace. *Description de la rotonde des panoramas élevée dans les Champs-Élysées : précédée d'un aperçu historique sur l'origine des panoramas, aux bureaux de la revue générale de l'architecture et des travaux publics* (Paris). 1842
- Michaux Emmanuelle. *Du panorama pictural au cinéma circulaire: Origines et histoire d'un autre cinéma, 1785-1998*. Editions L'Harmattan. 2000
- Robichon François. *Les Panoramas en France au XIXe siècle*. Thèse de doctorat, Nanterre. 1982
- Hyde Ralph. *Panoromania!: Art and Entertainment of the All-embracing View*. Trefoil Publications Ltd. 1988
- Philip, Cynthia, *Robert Fulton: A Biography*, iUniverse, 2003

Paper in journal:

- Laurent Lescop. Panoramas oubliés : restitution et simulation visuelle. *Cahier Louis-Lumière - Revue numérique annuelle de l'ENS Louis-Lumière*, École nationale supérieure Louis-Lumière, 2016, Archéologie de l'audiovisuel, 10, pp.49-64.
- Laurent Lescop, Jacques Athanaze Gilbert. Ambiance et immersion : dispositions, dispositifs et récits. Nicolas Rémy (dir.); Nicolas Tixier (dir.). *Ambiances, tomorrow. Proceedings of 3rd International Congress on Ambiances. Septembre 2016, Volos, Greece*, Sep 2016, Volos, Grèce. International Network Ambiances ; University of Thessaly, vol. 1, p. 307 - 312, 2016,
- Laurent Lescop. Le format du panorama. *Pli*, Architecture & édition, 2016, Format(s), pp.199-208

Creative Disruptions: Design Activity or Activism?

Introduction

“Public space is produced through public discourse, and its representation in not the exclusive territory of architecture, but is the product of the inextricable relationship between social action and physical space.” – Susana Torre¹

Design pedagogy for upper-level architecture students that has a practical dimension to solve real-life issues blurring boundaries between design activity and activism offers students opportunities to take on the role of *architects as social agents of change* in the built environment. This phenomenon applies to Pop-up/Tactical Urbanism projects in our cities and its public spaces. Such real-life possibilities allow students to provide critical support to citizen activists who play a direct role in shaping their cities with small scale DIY initiatives regarding both tactics and theory.

Students can test their knowledge and skills that employ analytical strategies, design development, material investigations, synthesis, and prototyping as prepositions of innovative design built interventions. Benefitting both students and citizen activists such projects are fabricated and deployed in real time and space as performative lived experiences whose efficacy can be tested as multiple public(s) interact.

This thesis considers such assertions through the framework of Sociologist Henri Lefebvre’s notion of space as a social product of *lived experiences*²; Situationists International’s concept of *derive* as a means to unravel the modern city; Alan Kaprow’s idea of *Happenings* in New York City as an alternative narrative of the mundane. These theories once layered against the contemporary interdisciplinary practices of firms such as *ReBar*³ provide yet another critical lens to interrogate the city combining art, design, and activism to redefine and reimagine our cities.

The questions I explore are: why is it essential to expose upper-level architecture students to real life problem-solving through the tactics of Tactical Urbanism and how can such an approach provide students with a social agenda to blur the boundaries between design activity and activism?

I argue that real-life projects in studio setting provide students an opportunity to solve problems that engage critical theoretical framework through which to offer

¹ Susana Torre, “Claiming the Public Space: The Mothers of Plaza De Mayo,” in *The Sex of Architecture*, ed. D. Agrest, P. Conway, and L. Weisman (Harry N. Abrams, 1996), 249.

² Lefebvre, *The Production of Space*, 429.

³ <http://rebargroup.org>

design strategies as creative disruptors. Using latest digital design and fabrication technology these projects serve as artifacts which can then be scaled to fit site-specific contexts using everyday quotidian sustainable materials. Such interventions can then be deployed in real space and time to test its value against how it functions thereby providing real-time data beneficial to both students and citizen activists.

To support my thesis, I present two case studies engaging fourth and fifth-year students and share its outcomes. The first was a Design Competition submitted for “Streetfest”⁴ in NYC by Storefront for Art and Architecture which was built upon the learnings from the “Bamboozlers” project in Focus Studio *Public Space: Sites of Actions*. The second project “Pop-up Peachtree,” was a direct response to Kennesaw State University Spring Arts Festival under the theme of *Homelessness* which the studio framed as *designing a shelter for an urban itinerant*. The two studio projects were real life design-build challenges where students followed a strict methodology of site analysis, design development, material investigations, synthesis, and prototyping as prepositions for design-build interventions. They were both deployed in real time and space as performative lived experiences where multiple public(s) interacted to get new readings of our public spaces.

Case Studies

“What makes a space public...is not its preordained “publicness.” Rather, it is when, to fulfill a pressing need, some group or another takes space and through its action makes it public” – Don Mitchell⁵



Fig. 01. Brainstorming: Issues of Public Space

Source: zamila karimi, 5th year focus studio- public space: sites of action(s)

The concept of public space as autonomous and experimental that promotes ordinary citizens to come together in a collective spirit regardless of cultural and social differences to create common good is a phenomenon that has historical roots in all cultures and time. However, within the contemporary context, this fact has manifested itself with exciting new possibilities in the public realm as per philosopher

⁴ 2015 Street Architecture Competition; Storefront for Art and Architecture <http://storefrontnews.org/programming/2015-street-architecture-prize-competition-winner-foamspace/>

⁵ Don Mitchell. *The Right to the City: Social Justice and the Fight for Public Space*.

Jurgen Habermas,⁶ that transverse both space and time, connects people together and empowers them with a new kind of freedom.

Case Study 1: Ondo (Bamboozlers)

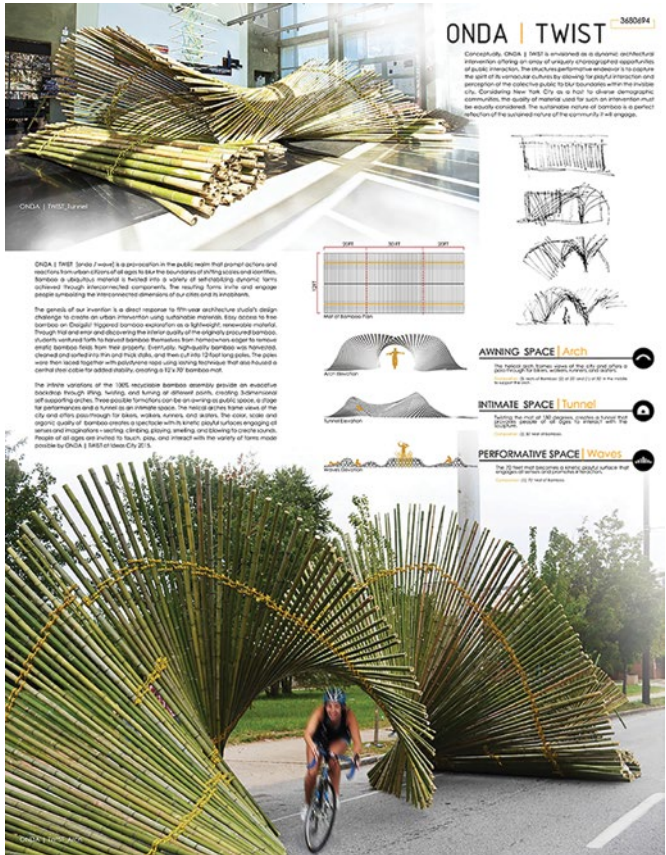

Fig. 02. Onda: Twist
Source: zamila karimi, streetfest competition board: storefront for art and architecture

Onda, is a provocation in the public realm that prompts actions and reactions from citizens of all backgrounds to blur the boundaries of shifting scales and identities in our cities. Bamboo a ubiquitous material is twisted into a self-structural powerful form through interconnected processes that conceptually invites and connects people on many different levels and forms despite the physical and emotional terrain of individual differences. The participants become a collective within this unique spatiotemporal collaborative event-based experiment choreographed in the public realm by *StreetFest*.

The dynamic form of the bamboo pavilion emerges by skillfully twisting approximately 12' x 19' bamboo mat at strategic points to create a 3-dimensional self-supporting performative device framing views within constricted spaces as pass-through for bikers, walkers, runners, and skaters. The color, scale and organic quality

⁶ Jurgen Habermas. In *The Structural Transformation of the Public Sphere*: MIT Press, 1991.

of bamboo create a spectacle for young and old to interact with its kinetic, playful surfaces engaging all senses and imaginations – seating, climbing, playing, smelling, blowing and creating sounds.

The genesis of *Ondo* is *bamboozlers*⁷ an outcome of a senior focus studio, I offered during Fall of 2014, at Southern Polytechnic State University⁸ now Kennesaw State University. *Public Space: Sites of Actions* challenged students to create a discourse that is both contentious and provocative on an interdisciplinary level engaging theory, research and creative practice of architecture at varying scales from the individual body to multi-dimensional bodies within a democratic urban space.

With the pedagogical goal of sensitizing students to the current events around the world, the course seeks to re-invigorate the debate around physical public space as staging grounds for social and political discourse post-2011 social movements and mass protests which is seen to this day. The unique nature of public space with myriad of possibilities and expectations meeting the needs of various public(s) is a contested issue that the present debate seeks to come to terms. The contemporary public space acts as a performative space that negotiates the needs for multiple public(s) including minority groups, LGBT, illegal immigrants – city's invisible to create a common discourse. A unique aspect of these performances is the complementary relationship between mass communications through social media and organizational tactics in the physical public space that empowers ordinary people in unprecedented ways in the public realm. Within such a landscape how can we architects as members and enablers of communities play a vital role in giving form to public spaces that reflect the contemporary narrative of our society - to envision a democratic space for all peoples to participate in?

Using the cosmopolitan city of Atlanta as a laboratory two groups of seven students each embarked upon the exercise *Public Space comes alive: host a site-specific intervention* for the citizen-led event *Atlanta Streets Alive (ASA)*⁹. In this exercise, students were asked to select a site on the bike route they deem necessary to re-purpose using temporary, ephemeral performative intervention technique as a design strategy that can be quickly deployed and taken down for the event. This case study presents Bamboozler's process and outcome.

Site Analysis

Building on the theory of insurgent urbanism, the goal was to create temporary urban interventions using sustainable/found materials as a strategic response to the site along the bike path. Through critical analysis using: observations; mapping; interviews and other tactics¹⁰ the students judiciously analyzed the site

⁷ Bamboozlers Focus Study Project Fall 2014

⁸ Southern Polytechnic State University (SPSU) merged with Kennesaw State University (KSU)

⁹ *Atlanta Streets Alive* Inspired by the open streets projects around the world is a biannual people-powered event that seeks to advocate connectivity amongst neighborhoods and communities – on foot, from street engaging physical activity to cultural and artistic endeavors.

¹⁰ Individual Test Walks (psycho-geographical - mapping derive – chance encounters – new readings) – Situationist International <https://www.youtube.com/watch?v=2SvdWk8zRrI>

both individually and collectively,¹¹ that was represented as an eidetic image¹² installation in the studio. External critics including ASA organizers¹³ provided valuable feedback which generated critical debate that the students had to contend with to justify the site selection. The selected site a people’s path in an empty lot that the locals use, to transverse between the neighborhood gas station, liquor store, and pawn shop on Boulevard is not a pedestrian friendly street. It is by no means a spot that the bikers favor nor the people who walk the parade chose to linger through. By selecting this site the student’s setup for themselves a challenge – to promote interaction amongst the diverse group of people(s) through a visually captivating artifact on Boulevard: blurring the boundaries between design activity and activism.

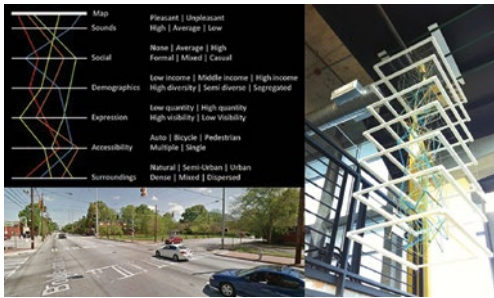

Fig. 03. Site Analysis Diagram

Source zamila karimi, 5th year focus studio- public space: sites of action(s)



Fig. 04. The Bamboozlers: Process Board

Source: fiorella dimiceli and kainoa keomaka, 5th year focus studio- public space: sites of action(s)

Design Development

After identifying the site, it was now time to move into design development. Each student started the process by analyzing a precedent as a research topic which became shared knowledge for the studio. Using strategies of brainstorming and charrettes students individually and in teams came up with possible interventions as design options. During pin-up with external reviewers, these options were critically interrogated regarding design, materiality, tectonics, fabrication, installation and experience within the public space. Although overwhelmed with the critique, the team went back to the drawing board to evaluate the pros and cons of each scheme and collectively came up with a strategy to move forward with a design vision: “*Our idea is to create a self-standing structure, which can generate form and space.*”

Fabrication & Testing

With a sound concept, the task was now to choose a sustainable material that

¹¹ Each student to keep a field notebook to take detailed notes of their accounts - of how life in public space develops as sequences and processes.

¹² An Eidetic image is defined by James Corner as “. . . a mental conception that may be picturable but may equally be acoustic, tactile, cognitive, or intuitive. Thus, unlike the purely retina impression of pictures, eidetic images contain a broad range of ideas that lie at the core of human creativity.”

¹³ Guest Reviewer, Leslie S Caceda - Atlanta Bicycle Coalition

was easy to acquire and construct/fabricate using the tools in the woodshop. With limited resources and budget constraints, students took to the local Craigslist¹⁴ to find materials which yielded a truckload of free bamboo stalks. In the woodshop, the first test model at ½ inch -scale as a surface began to take shape. Once the stalks were cleaned, cut and arranged into equal lengths, it was lashed together using a Carrick bend knot. The bamboo mat was then twisted into different configurations to explore different form and spaces. This test yielded many valuable lessons both aesthetically and structurally: a) the bamboo from Craigslist proved to be structurally weak; b) stalks of bamboo pieces that were tied together using a Carrick bend knot for test model was not going to be adequate for the final construct; c) visual and aesthetic decisions regarding color, texture, materiality, tectonics had to be detailed; d) the challenge of how to anchor the structure once it was twisted and given form so that it does it fall to lateral forces was an issue. All these questions had to be addressed before the final construction. The team bravely made the decision to harvest the bamboo from local area homes. Once, the fresh cut bamboo was selected and cut into right sizes they assembled in 3 pieces using both ropes at ends with Carrick knot and steel cable at the center for structural integrity as per the recommendation of Structure's Professor.¹⁵ Finally, the sandbag¹⁶ strategy was used to anchor the final installation at both ends once deployed at full scale.

With a very strict timeline, the students were now ready to go into construction and fabrication mode. From harvesting bamboo to cleaning and cutting into right sizes, to lashing it they all worked efficiently as a team in an assembly line. The final model comprises of 3 modules: 2 end modules of 12' 13' and a middle section of 12' 18.' Each module has a central steel cable reinforcing it and rope at each end at 3' connecting it. Throughout the process, students worked hard critically - planning and preempting each aspect of the installation so as to not have any surprises on the day of the event. As a final test the night before, the entire crew came together to deploy the installation in the desired form with an arch in the center - so that they could systematically record the process as a choreography to be re-performed manually on the day of the event within strict timelines with utmost precision and control.

Installatiown

On the day of Atlanta Streets Alive, students had only an hour to unload and set up the installation. They were well-organized and had planned out every detail from the staging area to offloading the heavy bamboo mat exactly on the location as planned once the street was closed to traffic. Through an incredibly coordinated effort, the entire team came together as one to choreograph the performance rehearsed the night before. Within 30 minutes or so the ubiquitous bamboo mat was deployed as a gigantic installation on Boulevard emphasizing the people path. With an arch in the center just as planned the bikers amusingly passed through the giant artifact with ease and delight during the bike parade and came back to it with their families and friends

¹⁴ Craigslist (stylized as craigslist) is an American classified advertisements website.

¹⁵ Professor Bronne Dytoc, Structures - KSU Architecture

¹⁶ Sandbags donated by Student Kai Keomaka family event business

to hang out on Boulevard. In no time, all people(s) – young and old, white, brown and black, men, women, transgender was engaged with the installation. They found interesting ways to interact and play with the artifact. The sheer scale and physicality of the form challenged all boundaries set forth – physical, social, political, cultural and emotional. Good design that is aesthetically pleasing, environmentally sustainable, structurally sound and programmatically responsive can provide moments of pause and relief despite the physical and emotional terrain of individual differences that exist within the public realm. This design-build performative experiment in real time and space on Boulevard proved to the students that we as architects are indeed social agents of change, who can provide critical support to citizen activists to play a direct role in shaping their cities with small scale DIY initiatives.

Case Study 2: Pop-up Peachtree (Shelter for an Urban Itinerant)

“Urban design and city building are surely among the most auspicious endeavors of this or any age, giving rise to a vision of life, art, artifact and culture that outlives its authors. It is the gift of its designers and makers to the future. Urban design is essentially an ethical endeavor, inspired by the vision of public art and architecture and refined by the science of construction.” – Donald Watson¹⁷

The course tackled issues of urban design through critically questioning 14-mile Peachtree Street, a major artery as it stretches from Downtown, Midtown, and Buckhead in Atlanta. Through observation and site analysis students mapped the many nuances Peachtree Street offers using experimental mixed-media. Site visits and access proved key to understanding the issues of urban space that is always in a state of flux both during public events and other occasions. Class discussions in the first half of semester were crucial as it brought forth opportunities and disparities that exist in Atlanta. Analysis on many levels: social, cultural, historical, physical, environmental, economical and more revealed layers of information that was critical to grasp to unravel the story of Peachtree Street.

Pop-up Peachtree, a short 3-week project was sponsored by Spring Arts Festival at KSU to engage the students to respond to the issue of homelessness as a means to understanding socio-cultural challenges of our cities. Responding to design challenge, *Pop-up Peachtree: create a shelter for an urban itinerant*, students in 4th year Urban Lab studio devised a strategy using pop-up urbanism tactics to activate otherwise desolate urban spaces with design-build temporary artifacts. It was particularly an important module as it allowed students a hands-on practical project to experiment with and get citizen reactions on many levels. Although the pace felt rushed, it allowed students to collaborate using design-build as a medium to test concepts of urban design.

¹⁷ <http://www.urbandesign.org/civicart.html>

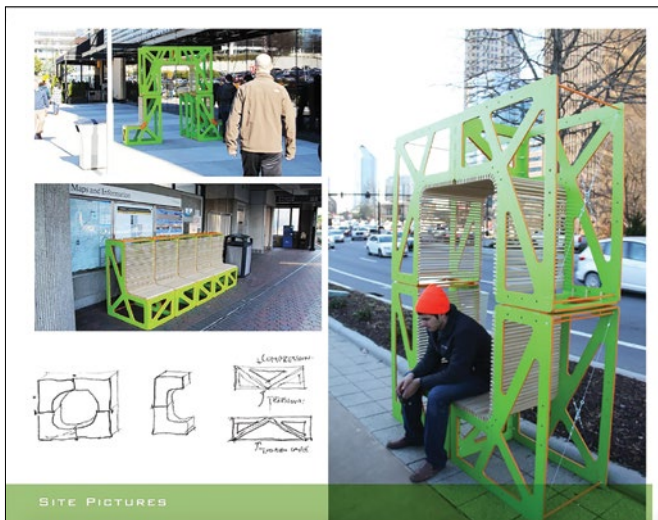

Fig. 06. Pop-up Peachtree:
Shelter for an Urban Itinerant.
Source: *evan saadat, 4th year
urban lab studio*

This case study presents one group's design which proved to be enormously successful. This installation has been invited to many public events, because of its modular nature, human size and ease of movement by one person as per the intent of the design. The design-build process follows the methodology: precedence analysis and charrette, design development, material investigations, digital fabrication, and assembly. Students in the team came up with various design strategies individually which were presented to external critics from Spring Arts Festival at KSU. It generated critical debate about the notion of shelter for an urban itinerant regarding form, function, modularity, transportability and cost. After many iterations, U-shaped modular chair concept was selected by the group as a design strategy. Using digital design strategies, the concept was modeled at various scales using different materials to test its constructability within the time frame and budget. Once material and finishes, were finalized it went through final mockup ready for fabrication at full scale.

Using Rhino, the modular chair is a kit of parts to be assembled in many ways to create urban intervention serving various functions. Digital files were used to CNC the 4'x8' MDF in the woodshop with technical assistance from the shop. These components were creatively and strategically designed using a combination of shapes with ornamental motifs that served as connectors for various configurations. Once cut the pieces were sanded and painted using vibrant colors to create a colorful urban furniture in the landscape. The set-up of this simple system can be deployed in many different configurations: individual benches or as a group seating; a surface to lie on or as an archway awning and more. The design is responsive to its context and is versatile in many different settings/situations. Its bright colors and playful character is an invitation for young and old of all backgrounds to engage and interact with.

Involving the public in the physical testing of ideas can yield unique insights into the expectations of future users and the types of design features for which they yearn: truly participatory planning should go beyond drawing on flip charts and maps. They create vibrant places that spark our imaginations to offer alternative readings of

otherwise dull urban spaces and raise provocative questions about the public, private and citizen ownership and control.

These two case studies directly from upper-level architecture studio support my hypothesis that real-life projects in studio setting provide students an opportunity to solve problems that engage critical theoretical framework through which to offer design strategies as creative disruptors to citizen-led initiatives. These tactical urbanism projects provide opportunities to blur the boundaries between design activity and activism, thereby allowing students an opportunity to take on an active role as emerging architects as social agents of change in the built environment.



Fig. 07. Parking Day: Midtown

Source: zamila karimi, kennesaw state university

Fig. 08. Creative Disruptions: Design Activity or Activism?

Source: zamila karimi, Kennesaw state university

Bibliography

Books:

- Bishop, Claire. "Antagonism and Relational Aesthetics." *OCTOBER* (2004). *Artificial Hells : Participatory Art and the Politics of Spectatorship* [in English]. London; New York: Verso Books, 2012.
- Bryan-Wilson, J, *Art Workers: Radical Practice in the Vietnam War Era*. University of California Press, 2009.
- Corner, James, and Alex MacLean, *Taking Measures Across the American Landscape* (New Haven: Yale University Press, 1996).
- Debord, Guy; Kotányi, Attila & Vaneigem, Raoul "Theses on the Paris Commune." In *Situationist International Online*, 1962.
- Deutsche, Rosalyn. *Evictions: Art and Spatial Politics*. Mit Press, 1998.
- Habermas, Jurgen. "Introduction: Preliminary Demarcation of a Type of Bourgeois Public Sphere." In *The Structural Transformation of the Public Sphere*: MIT Press, 1991.
- Harvey, D. *Rebel Cities: From the Right to the City to the Urban Revolution*. Verso 2012.
- Hou, Jeffrey. "Beyond Zuccotti Park: Making the Public." The Design Observer Group, 2012.
- Lefebvre, Henri, and Donald Nicholson-Smith. *The Production of Space*. Vol. 30: Blackwell Oxford, 1999.

- Karimi, Zamila R. *Spaces of Activism: Occupy Montreal*. McGill University Thesis, 2013
- Massey, Jonathan and Snyder, Brett. "Occupying Wall Street: Places and Spaces of Political Action." The Design Observer Group, 2012.
- Mitchell, Don. "The End of Public Space? People's Park, Definitions of the Public, and Democracy." *Annals of the Association of American Geographers* 85, no. 1 (1995).
- The Right to the City: Social Justice and the Fight for Public Space*. Guilford Press, 2003.
- Sennet, Richard. "The Public Realm." In *The Blackwell City Reader*, edited by Gary and Watson Bridge, Sophie: Wiley, 2010.
- Torre, Susana. "Claiming the Public Space: The Mothers of Plaza De Mayo." In *The Sex of Architecture*, edited by D. Agrest, P. Conway and L. Weisman: Harry N. Abrams, 1996.

Website:

- <http://www.atlantastreetalive.com> (accessed 04.01.2017).
- <http://www.urbandesign.org/civicart.html> (accessed 04.11.2017).
- <http://rebargroup.org> (accessed 04.12.2017).
- <https://en.wikipedia.org/wiki/Craigslist> (accessed 04.15.2017).
- <http://storefrontnews.org/programming/2015-street-architecture-prize-competition-winner-foamspace/> (accessed 04.25.2017).

Barbara E.A. Piga ^a, Eugenio Morello ^a, Marco Boffi ^b, Nicola Rainisio ^b,
Giovanni di Liberto ^b

^a Laboratorio di Simulazione Urbana Fausto Curti, Department of Architecture and Urban Studies, Politecnico di Milano, Milan, Italy, ^b Department of Cultural Heritage and Environment, Università degli Studi di Milano, Milan, Italy

Sharing the experience of urban design schemes through immersive simulation

Introduction: aim and research context

The recent activity of citizens' engagement for communicating the redesign scheme of an urban street using immersive simulation techniques is presented in this paper. The use of multiple tools during events with lay people and local stakeholders was tested in order to investigate the potential use of novel technologies for improving the understanding and the sharing of information in relation to urban transformation processes. In particular, the focus of this paper is about the use of immersive and dynamic experiential simulation in public events. The evaluation of the enabled experience was supported by the direct observation of people reactions to simulations and through dedicated surveys submitted right after the visualizations.

The research domain of this activity is experiential simulation. Recent ICT development enables today to develop impressive tools for enhancing the quality of multi-sensory simulations: firstly, the quality and speed of image production has tremendously accelerated through fast-rendering techniques that will lead in the near future to trial-and-error processes whereby almost real-time alternative design solutions will be tested in co-design activities (responsive loops); secondly, novel visualization modalities through immersive reality, completely change the fruition of simulations from static and distant objects to fully engaging tools (experiential simulation).

The proposed exploration is based on the use of novel envisioning tools, in particular immersive reality, transferred to the communication of urban design transformation. In particular, as a long-term research objective, we want to investigate how the use of these tools – and in general architectural simulation – in design and co-design domains can impact the evaluation of design schemes and the overall progress of the design process.

Only few examples of similar applications are available and have been

exhaustively documented¹. We argue that the experience is still unripe because of the following reasons: firstly, technologies are under continuous refinement, and the rapid evolution of the tools did not allow to root these tools in the practice with a reasonable level of maturity in the urban design domain; secondly, the rapid evolution was not well documented by scholars operating in the domain of visualization of architecture and the design of participatory design processes²; thirdly, people are simply not trained and used to visualize virtual environments through immersive technologies, and this affects – or even alters – their evaluation of displayed scenarios. For instance, the ‘surprise effect’ resulting from the use of immersive viewers for the first time can distract from the evaluation of the content, i.e. the design scheme represented by the visualization.

The case-study application

The regeneration project called “Ripensiamo insieme via Celoria!” (Let’s imagine via Celoria together!) was launched as part of the sustainable campus initiative running on our district between the two major universities, namely the Politecnico di Milano and the Università degli Studi di Milano. The project proposes the redesign of a public road that represents the *trait d’union* between the two universities. Potentially, the street could represent the core of the district and it is also located at the very centre of the campus. In short, it could become the university walk crossed every day more than 20.000 students. Nevertheless, today the street is a neglected space, and its major function is to host the cars of the university commuters. Recent sustainable mobility policies, declining trends of car ownership, and resilient water management solutions of public open spaces, are only few of the topics that legitimate the civic willing to give back this space to people for hosting social activities and eco-systemic services.

The design exploration started in 2014 with the production of three schematic transformation scenarios, with the idea of opening a debate with public stakeholders and people. For instance, the idea was not to influence people with an established solution (which, indeed, we did not have at that time), but to initiate an engagement process and listen to people issues. This first part of the process is summarized in a previous paper by the authors in 2015³.

After the first phase of listening to community needs and meeting with public stakeholders in 2015, a design scheme collecting all the inputs was produced with the idea of giving it back to people evaluation and gather reactions. The new design scheme mainly proposes the removal of most of the car parking lots that cover most of the horizontal surfaces today, the introduction of traffic calming solutions and the substitution of pavements and furniture.

According to our design approach, a photorealistic representation of the future

¹ On the use of digital visualizations for participatory planning for landscape design and urban design: Appleton & Lovett, 2005; Bates-Brkljac, 2007; MacFarlane et al., 2005; Wergles & Muhar, 2009.

² One solid reference to our research is represented by the work of Eckart Lange at the University of Sheffield, UK (Lange, 2005; Bishop & Lange, 2005).

³ Piga et al, 2015

scheme based on dynamic and immersive simulation was the proper modality towards the twofold aim of engaging (more) people with a trustful anticipation of future spaces and at the same time communicating the sense of experience as close as possible to future reality, in order to collect informed reactions to the future atmosphere of the envisioned place. Figure 1 represents a snapshot of an immersive tour of the road, which was depicted before and after the proposed transformation. The engagement phase activated through the use of immersive simulation is the object of this paper and is presented in the next section.



Fig. 01. The simulated urban environment: above, the digital representation of the current street landscape and below, the proposed design scheme.

The application: using immersive simulation in public events

Three public events provided the testbed for our methodology. The first occasion was an evening meeting organized at the municipal hall totally dedicated to the exploration of the redesign project. On the opposite, the second and the third events were outdoor activities (one happening directly on the street interested by the redesign process), which were not directly related to our exploration, because one was the Spring Party organized by the students and the second was a day dedicated to outdoor sport activities. This remark is important because not all the people we engaged during the events had a precise idea about the street redesign project, hence totally free of any prejudice about the transformation.

Our first scope was to achieve the engagement of people during the public events. Literally, we had to catch their attention and invite them to test our simulation and join our debate about the proposed urban transformation with different products: the use of immersive simulation with Head-Mounted Displays (HMD), i.e. visors and cardboards equipped with smartphones, a selfie-wall, i.e. a big printed poster

depicting the envisioned future environment, and a physical model of the street in scale 1:200 (Fig. 02). Moreover, the digital advertisement and engagement happened through social media⁴ along the whole process, and it is indeed a powerful tool for continuously and a-synchronously engaging people in the discussion and provide a repository of our work.



Fig. 02. Used tools: Head-Mounted displays; selfie-wall and physical model.

Moreover, social offer now the possibility to add panoramic images that people can navigate by scrolling the mouse.

The experiment

The experiment consisted in the testing of the immersive spherical panorama of the envisioned transformation of the street with people during the events. The transformation was shown as a 3-D photorealistic virtual model of the street, depicting an ordinary day, including also some noise features like dust and leaves on

⁴ A Facebook page was created (<https://www.facebook.com/Via-Celoria-Milano-Citt%C3%A0-Studi-Campus-Sostenibile-433083053490339>)

the pavements. Three were the spots on the street offered to the users, which were able to navigate through the scenes simply pressing a button on the visor. The introduction of noise and small features that help in giving back the atmosphere of a place into a rendered image, is a crucial aspect in order to increase the sense of legibility and recognition of an environment, thus eliminating the feeling of distance that sometimes digital representation generates to the observer⁵.

After the immersive experience with the visors which lasted few minutes, the observer was asked to fill a survey aiming at evaluating the reaction to the digital immersive environment. The final goal of this inquiry was to support our future research in the production of more engaging and reliable images.

The survey was based on the seminal work in the discipline of environmental psychology consolidated in the late 80ies, whereby a number of scholars investigated the relationship between man and the (built) environment, in order to extract clues about affordances, quality and well-being generated and offered by the built environment⁶. This wide dataset was able to provide a varied and holistic picture of how the chosen location could be perceived once designed and built. In particular, the dispensed survey covered four main areas, whose items were pre-tested during the first event and then adapted for the final version during the second and third ones. Firstly, taking inspiration from the *preference matrix*⁷ four variables of environmental preference have been investigated through appropriate items: coherence, legibility, complexity and mystery. Secondly, the perception of other immaterial features linked with psychological well-being has been analysed referring to *flow*, a construct described by Csikszentmihalyi (1975/2000) that defines a condition of engagement and enjoyment lived by people while performing challenging tasks; it allows to characterize the kind of interaction with the environment experienced by people. The third part has been designed including the ITC-SOPI developed by Lessiter and colleagues (2001), to measure the sense of presence elicited by the tools used by participants to explore the digital environment. Finally, we have included a fourth part with free adjectives to be associated to the environment, to capture spontaneous feedbacks on place perception; this last part has investigated also the local affordances in terms of possible actions to be performed there. This wide dataset was able to provide a holistic picture of how the chosen location could be perceived once built and about the psychological well-being that it might elicit.

Evaluation of the design proposals

Concerning the evaluation of our work and the overall activity about the use of immersive simulation, we mainly refer to two modalities: the sound recording of the direct feedback by people during the events, and a more scientific modality consisting in a survey submitted right after the experience of the immersive simulation.

The collection of suggestions occurred in different modalities: talking to people,

⁵ This topic is well documented by Kepczynska-Walczak & Walczak (2013)

⁶ The main references refer to the well-known research work by Kaplan & Kaplan (1982, 1987) and Gibson (1979)

⁷ Kaplan & Kaplan, 1982

taking notes, audio and video recording and taking pictures of people during and right after the experience of immersive simulation. This part of evaluation did not follow a scientific protocol and refers more to a qualitative assessment about both the content of the visualization and the usability and appreciation of the technology. We did not notice any significant obstacle in using the technology considering the age of the users: both young and old people completed the experiment without major hinders or complains.

During the three events we collected 203 surveys in total, as reported in Table 01. The filling out of the questionnaire and the interpretation of the data is still ongoing and will be the subject of a future paper.

Table 01. Facts about the questionnaires collected during the event

Event	Filled questionnaires
Presentation at the Municipality 3 Hall, 18.04.2016	29
Spring Party, 20.05.2016	122
Sport Day, 28.05.2016	52

Considerations and future work

During the activities carried out in 2016 we collected numerous reactions that will inform the refinement of the design solution by including the final observations that are pertinent with the development of the design scheme.

Afterwards, we will present again the refined design scheme to local representatives of the public municipality, and the redesign of the street will be included in the larger envisioning scenario for the whole university district that is currently in progress, after the decision of the State University to relocate the scientific schools to another campus, thus opening completely new scenarios of occupation for large portions of the district. Of course, this new and unexpected scenario will completely change the center of attention of the public discussion. Nevertheless, the improvement of the environmental quality of the public space in the district becomes even more relevant in a process of temporary abandonment and new inhabitation of large portions of the district.

Concerning the use of immersive simulation in public events, our experience shows that the proposed modality for engagement and co-design is very powerful and at the same time very delicate. In fact, on one side, it can improve the understanding of the future built environment, on the other it can manipulate the evaluation of proposed design solutions, because people tend instead to evaluate the device and the immersivity of the experience. In fact, the “wow effect” of immersive reality can distract the observer from the main scope of her/his task, but the novelty of the experience will be reduced in the future once HMDs will be widely diffused. Moreover, the content of the displayed image has to be coherent with the expected outcome in place according to ‘ecological validity’ principles.

Finally, the use of immersive simulation was used in this work for sharing information and communicating the photorealistic representation of a design scheme.

Future work will extend the application to co-design processes in a continuous refinement of design solutions together with citizens and stakeholders. If this task seems to be too expensive and time-consuming under current conditions, it will be less and less the case in the future with the improvement of fast rendering techniques.

Bibliography

- Appleton, Katy; Lovett, Andrew. „GIS-based visualisation of development proposals: reactions from planning and related professionals. *Computers, Environment and Urban Systems*. vol 29:3. 2005. p. 321-339.
- Bates-Brkljac, Nada. “Investigating perceptual responses and shared understanding of architectural design ideas when communicated through different forms of visual representations”. In: Banissi, Ebad; Burkhard, Remo Aslak; Grinstein, Georges; Cvek, Urska; Trutschl, Marjan; Stuart, Liz; Wyeld, Theodor G; Andrienko, Gennady; Dykes, Jason; Jern, Mikael; Groth, Dennis; Ursyn, (eds.), *Proceedings of the 11th International Conference on Information Visualisation*. Zurich: IEEE. 2007. p. 348-353.
- Bishop, Ian D.; Lange, Eckart. *Visualization in Landscape and Environmental Planning: Technology and Applications*. London, New York: Taylor & Francis. 2005.
- Csikszentmihalyi, Mihaly. *Beyond boredom and anxiety*. 1975/2000. San Francisco: Jossey-Bass.
- Gibson, James J. *The ecological approach to human perception*. 1979. Boston, MA: Houghton Mifflin
- Kaplan, Stephen. Aesthetics, affect, and cognition—Environmental preference from an evolutionary perspective. *Environment and Behavior*. vol. 19:1. 1987. p. 3-32.
- Kaplan, Stephen, & Kaplan, Rachel (eds.). *Cognition and environment—Functioning in an uncertain world*. 1982. New York, NY: Praeger.
- Kepczynska-Walczak, Anetta; Walczak Bartosz M. “Visualising «genius loci» of built heritage”. In: Morello, Eugenio & Piga, Barbara (eds.), *Envisioning Architecture: Design, Evaluation, Communication, Proceedings of the 11th conference of the European Architectural Envisioning Association*, Rome: Edizioni Nuova Cultura. 2013. p. 451-457.
- Lange, Eckart. “Issues and Questions for Research in Communicating with the Public through Visualizations”. In: Buhmann, Erich; Paar, Philip; Bishop, Ian David; Lange, Eckart, *Trends in Real-Time Landscape Visualization and Participation*. Anhalt (Germany): 6th International Conference on Information Technologies in Landscape Architecture. 2005. p. 1-11.
- Lessiter, Jane; Freeman, Jonathan; Keogh, Edmund; Davidoff, Jules. “A cross-media presence questionnaire: The ITC sense of presence inventory”. *Presence: Teleoperators, and Virtual Environments*. vol. 10. 2001. p. 282-297.
- MacFarlane, Robert; Stagg, Harry; Turner, Keith; Lievesley, Matthew. “Peering through the smoke? Tensions in landscape visualization”. *Computers,*

Environment and Urban Systems. vol 29: 3. 2005. P. 341-359.

Matsuoka, Rodney H.; Kaplan, Rachel. "People needs in the urban landscape: Analysis of Landscape And Urban Planning contributions". *Landscape and Urban Planning*. vol. 84:1. 2008. P. 7-19.

Piga, Barbara E.A.; Morello, Eugenio; Shokry, Gaia; Salerno, Rossella. "A toolkit for collaborative design: envisioning and sharing the identity of place through traditional and emergent techniques of simulation". In: Kepczynska-Walczak, Anetta (ed.), *Envisioning Architecture: Image, Perception and Communication of Heritage, 12th International Conference of the European Architectural Envisioning Association Conference*, Lodz: Lodz University of Technology. 2015. p. 418-426.

Wergles, Nathalie; Muhar, Andreas. "The role of computer visualization in the communication of urban design: A comparison of viewer responses to visualizations versus on-site visits". *Landscape and Urban Planning*. Vol 91:4. 2009. P. 171-182.

Website:

<https://www.facebook.com/Via-Celoria-Milano-Citt%C3%A0-Studi-Campus-Sostenibile-433083053490339> (accessed 24.04.2017).

Jack Breen

Form & Modelling Studies, Faculty of Architecture and the Built Environment
Delft University of Technology, Delft, The Netherlands

Form and Visualisation: Development, Implementation and Evaluation of an Integral, Foundational Imaging Study Program

Topics

Form Study Themes and Methodology; Thinking by Envisioning; Representational and Designerly Drawing; Physical and Digital Modelling; Visual Communication and Graphic Design; Integration and Evaluation.

Introduction

How should one go about creating a wholly new educational program – with the aim of furthering the understanding of architectural Form and the development of essential Visualisation skills – within strictly defined constraints, concerning the available study time and academic staff, plus a binding, interdisciplinary curriculum organization?

This Paper documents the thematic integration and thorough ‘re-design’ of pre-existing foundational courses into two ‘twinned’ first-year Bachelor teaching applications, with ‘Form and Visualisation’ as their guiding theme.

The challenge was set some four-and-a-half years ago, when the faculty’s (then) Dean decided to completely re-organize the existing Bachelor curriculum. The aim: to create an efficient and cost-effective integral study program, with clearly identifiable components and intellectually stimulating and creatively challenging new course concepts.

The consequences of the initiative were far-reaching and involved re-defining – and frequently re-inventing – teaching methods and -contents. All of the new BSc programs would be required to fit into a rigorous, top-down, three-year time-frame, whereby the subjects of wholly different disciplines (in our case: Building Technology and Architectural History & Theory), would need to be offered simultaneously, in parallel trajectories.

Whilst the ‘old’ program was still up-and-running, a busy half-year was spent developing a tightly organized conglomerate of interwoven educational modules. Then (some four years ago) the entire Bachelor curriculum was re-launched in one go: a logistically and pedagogically challenging operation, to say the least!

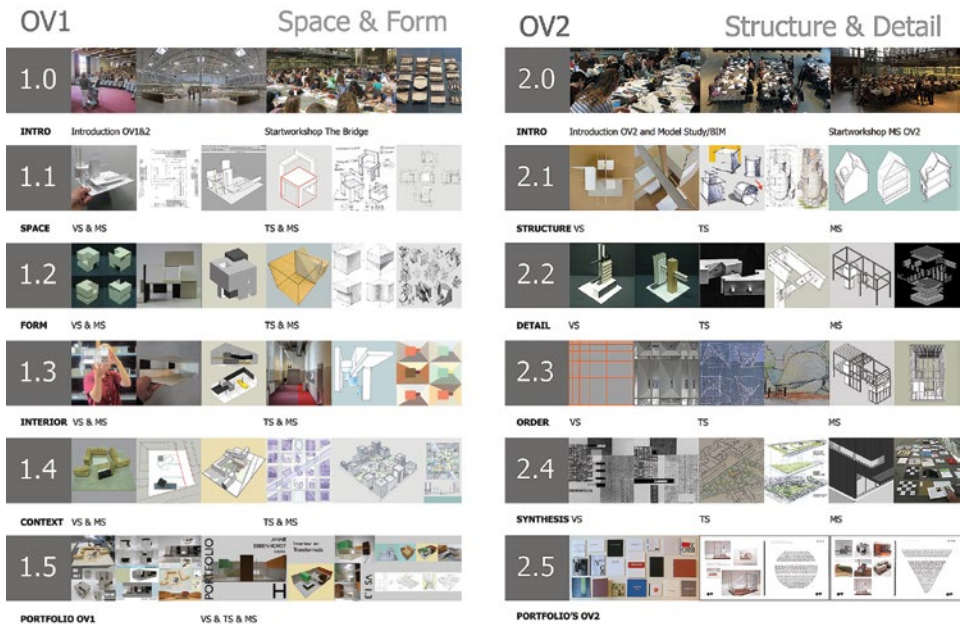

Fig. 01. Organisation overview of the two F&V (OV) modules.

Source: author

Organisation

The new Form and Visualisation programme which was envisioned was to consist of three, interrelated ‘Modules’: two in the first year of study and a third at the beginning of the second year. The author was appointed as coordinator of the first two modules and was, initially, closely involved in the development of the third one, focusing on computational design and representation.

The first F&V module (subtitled: ‘Space & Form’) became one of the two modules that simultaneously kick-off the first Bachelor year as a whole. It takes up a third of the study-time of the first ‘quarter’, spanning ten weeks in all.

The second F&V module (subtitled ‘Structure & Detail’) takes place in the third quarter (from the beginning of the second half of the year), after Design Module 1 in quarter 2 and preceding Design Module 2 in quarter 4.

The third F&V module (subtitled: ‘Parametric Design’) is offered in the first half-quarter of the second BSc year. It became the full responsibility of the faculty’s Informatics group and is therefore not considered in the context of this evaluation of the – first year – Form and Visualisation programme.

The two first-year F&V modules were conceived and developed as a two-step, interrelated learning programme. The intention: to get new students to begin to appreciate and to recognize the fundamental compositional and perceptual phenomena of architecture, whilst at the same time getting them to develop essential creative- and analytical visualisation and communication skills. The further idea was that the two modules would contrite towards them developing thematic insights and visualisation-

and modelling skills that they would be able to apply in the next – design – modules.

Within these two F&V modules, three existing teaching disciplines were brought together organisationally, thematically and didactically:

- Form & Modelling Studies;
- Freehand Drawing;
- Informatics.

These disciplines have – as much as possible and indeed: desirable – been developed as thematically interrelated entities, whereby the original educational methods and cultures are still to a substantial extent recognizable within the three, newly determined F&V subdomains:

- Form Study (FS);
- Drawing Study (DS);
- Model Study (MS).

The first-year programme kicks off in week 1 with a collective workshop in which all of the students (and staff members) participate. In the set task – The Bridge – a thematic exchange is sought with the first ‘parallel’ module: Technology 1.

Form Studies

In the Form Studies programme at the Delft Architecture faculty, students are stimulated to start recognising fundamental themes on the level of composition and perception.

To trigger an on-going interest in the domains of form-giving, a series of brief (one half-day), but intensive designerly exercises has been developed, fine-tuned and perfected through the years. The content and didactics of the specific applications and the programme as a whole are continuously under scrutiny, whereby the ambition is to offer an eye-opening educational course that will stimulate further thematic explorations throughout the student’s further years of study and ... into practice.

The working-method in the tutored study-sessions is to offer all participating students a clearly-defined compositional task with constraints and specified study-products, on the basis of a given set of working-materials or situation.

The intention is that, during the lesson, the student gets regular feed-back from the group’s Form Studies Tutor and that the result of the spatial composition-study is completed and documented before the next guided session (in two weeks’ time), in self-study.

Each first-year OV module contains four specific Form Studies tasks, the result of each of which is an integral, physical study-model, which are documented by making drawings, photographs or digital 3D models, as well as seeking references and writing a short analytical text on the basis of the thematic exercise.

The products of all eight FS tasks set in the first year (in F&V 1 and 2) are presented in an individual, graphic document, the Form Studies Year 1 Booklet, handed-in at the end of the third quarter.

The themes of the FS exercises:

- OV1.1 and 1.2: Space, Form and Massing: Dynamic Perspective;
- OV1.3 and 1.4: Form & Counter-form: Interior & Urban space’

- OV2.1 and 2.2: Structure and Connection: Construction & Detail;
- OV2.3 and 2.4: Dimension and System: Proportion & Collage.

Form Studies is further offered in elective courses: the third-year free-choice, international Minor House of the Future and MSc elective courses Form & Modelling Studies.

Drawing Studies

Drawing is one of the most elementary and evocative of design-skills which, despite the steady influx of computer-based visualisation-techniques continues to be recognised as an essential aspect in the BSc learning-cycle.

Traditionally, the emphasis in the (free-hand drawing) teaching programmes lay on representational drawing, generally involving the accurate visual documentation of a given set of elements or –surroundings.

However, it was questioned if this traditional approach would be fitting in the context of the new BSc curriculum, in the context of F&V1 and 2.

Some problems that needed to be addressed:

- the amount of time allotted for guided teaching-sessions would be very limited, coming down to a maximum of 4 to 5 hand-on teaching sessions in a drawing studio per module;
- the limited, basic drawing skills of the participating first-year students, many of whom proved to have hardly any recent drawing-experience;
- the desire to stimulate explorative- and analytical drawing on the level of design and research, rather than aiming at traditional standards of ‘artistic’ representation.

It took considerable time - and effort - to get the staff-members of the original free-hand drawing team to enthusiastically develop the envisioned, new drawing programme. Due to various reasons, the bulk of the teachers left the faculty at the end of the first F&V year. Their place was taken in by enthusiastic guest-lecturers, who have contributed considerably to the furthering of the new first-year Drawing Study course.

A meaningful difference is that ‘designerly’ modes of drawing have been given more prominence in the programme, meaning that the students are essentially set form-variation tasks, which stimulate their design-visualisation skills that can be then be put to good use in the following design-modules.

As a consequence, drawing-from-perception of specified objects or spaces now tends to take up the first half of the studio-lesson, after which, in the second half, the emphasis shifts towards more design-like, experimental drawing, which is continued and further developed in self-study.

The results of the individual explorations are reviewed in the next DS lesson, two weeks later. Per module, the results of the drawing-exercises are featured in the individual Portfolio.

The themes of the MS exercises:

- OV1.1 and 1.2: Object and Space: Rectangular & Triangular shapes;
- OV1.3 and 1.4: Interior and Context: Central & Aerial perspective views;
- OV2.1 and 2.2: Massing and Connection: Combined & Exploded views;
- OV2.3 and 2.4: Complexity and Presentation: Posters & Portfolios.

At present the Drawing Studies programme is only part of the first-year F&V programme, but initiatives are being developed towards further integration in the BSc design projects and possibly: more specialised elective applications.

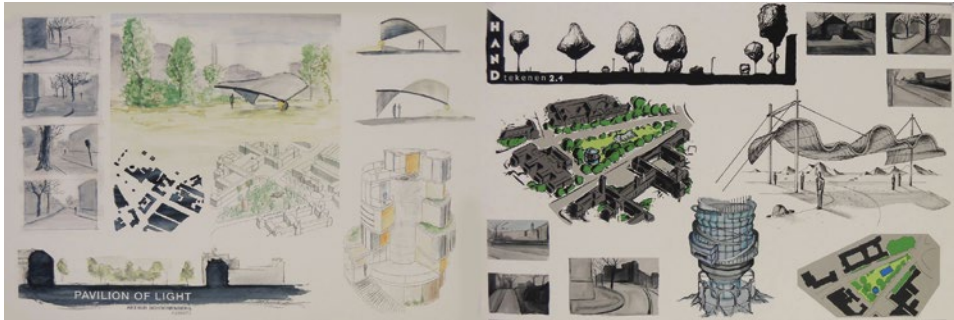

Fig. 02. Examples of presentation posters of the F&S2 Drawing Studies programme].

Source: author

Model Studies

Design-based Modelling has always played an important role at the Delft faculty of Architecture and continues to do so, not only in the context of the F&S programme, but also on several other levels of the BSc and MSc curricula, down to the final MSc Thesis-projects.

As such, the aspect of physical, design-based modelling is introduced from the very beginning, as an integral part of the first-year's kick-off project – The Bridge – in week 1.

During the first weeks all new students to the faculty follow an introductory course on the level of modelling techniques, in which they are acquainted with the faculty's modelling-workshop facilities and the available computer-aided modelling applications (CAM-lab). After that, explorative, hands-on modelling plays a central role in the Form Studies programme, whereby the essential outcome of each set task is a – presentable – study model.

Apart from physical modelling, the F&V modules target the development of various digital modelling skills. In the first module, the new students become acquainted with easy-access 3D-modelling techniques, whereby 3D 'Sketch' modelling is made instrumental, as an extension of the Drawing Studies and – particularly – Form Studies exercises.

For all of the FS (and part of the DS) tasks in F&V1 and 2, the students are required to document their tangible, physical results using SketchUp (or similar) applications. This allows them to fine-tune their spatial object and, by using different Layers and Views, create representative images on the basis of their work, which are then used in their F&S Portfolio's.

In Form & Visualisation 2, the approach to 3D modelling is distinctly different, whereby a third part of the course as a whole is reserved for the development of elementary Building Information Modelling (BIM) skills, with the faculty's Technical

Design and Informatics group (TO&I).

The intention in this application is that students begin to develop 3D technical modelling skills, making use of integral, product-based digital techniques (in this case: working with Revit).

As these are their ‘first steps’, the idea is to keep the task relatively simple, but stimulating. After experimenting with a ‘Water Loft’ in the first two instalments of F&V2, the choice has been made to let them develop the last of a relatively familiar (typically Dutch) row of houses. Each student develops and models his-or-her own design proposal and at the end of the module hands in a set of technical- and presentational files.

To get the students to ‘hit the ground running’ when it comes to this sub-project, an integral workshop is organised during the first F&V2 day, whereby students are asked to develop a concept on the spot, by drawing and physically modelling a first concept, which they take with them to their first MS lesson.



Fig. 03. Two examples of F&V1 digital Portfolio files.

Source: author

Portfolios

Each of the two F&V modules begins with a kick-start project on day 1 and ends with a personal Portfolio, which is handed-in in week 10. The idea of these Portfolio's is that students also learn to develop graphic-design skills to present and communicate their study-results.

In F&V1 students are asked to make a compact, concise digital presentation of their work during the course of the module: a PowerPoint (or PDF) presentation of 10 slides:

- An introductory slide, with name, title and opening image;
- Eight slides corresponding with the exercises (4 for FS and 4 for DS);
- A closing slide, with a collage, quote or reflection on the module.

In F&V2 the set-up is different, whereby the individual students hand-in three different sub-portfolios:

- A graphically professional booklet of their first-year FS results;
- A physical folder of drawings and presentation-posters for DS;
- A digital folder of model-files and presentation renderings for MS.

The aspect of graphic visualisation is a central theme, whereby platforms like Illustrator and InDesign are brought under the students' attention.



Fig. 04. A selection of FS booklets handed in at the end of F&V2.

Source: author

Results and Developments

By the time of EAEA conference, the new Form and Visualisation program will have completed its fourth educational cycle. Time for an evaluation of didactic methods, teaching content and educational results...

The first instalment of F&V1 in 2013 was both enervating and uplifting. The first start-workshop – The Bridge – was a success and the exercises went very well, leading to a good score for the module as a whole.

F&V2 as yet proved to be more difficult, whereby particularly the integration of the Informatics exercise was not yet optimal.

Throughout the first four years, meaningful changes have steadily been introduced, with subject matter, planning and methodology constantly being discussed, redeveloped, tested and fine-tuned on the basis of feed-back from students and staff.

Some of the most meaningful changes:

- In the second instalment, the start-week with the integral Bridge-project was repeated, but it became clear that this set-up led to problems in week 5, in which students were required to do written exams for the other module. In instalment 3, the workshop was concentrated on one day, meaning that normal lessons could begin in week 1 and a lesson in week 5 could be skipped, leading to less deadline-stress for the students.
- Similarly, the number of lectures was gradually brought back, with an integral start-lecture at the beginning of both F&V1 and 2 as well as half-way though F&V1.
- Changes in staff were something to deal with from the first instalment onwards. Due to the departure of drawing teachers and a prominent Form Studies tutor

- after the first year, new staff-members had to be brought in. On the whole the introduction of new (guest) teachers worked well, speeding-up the renewal of the drawing exercises and bringing new blood into the FS group. In each of the four instalments, a different Informatics staff-member was involved in the MS course.
- At the beginning of the fourth instalment of F&V2, apart from the usual graphic design introduction, a special InDesign instruction was given. All students were required to use the same basic format (21 22 cm) for their FS booklet design.
 - At the beginning of the first instalment the number of new students was still quite oversee-able (initially some 240 first-year students). This was a good thing for the implementation of the newly developed (and –developing) programme. In the last instalments, student-numbers have increased to around 380, meaning a less-than-optimal situation for student-tutor interaction.

Conclusions and Perspectives

After four years of developing, fine-tuning, re-arranging and performing, the new BSc programme as a whole seems on the to be working well. A negative point is its rigorous structure, which allows as good as no flexibility for students or staff-members. A positive aspect is that the BSc curriculum has become more of a whole, educationally and that there is far more interaction between teaching-colleagues from different disciplines.

Within the whole BSc conglomerate, the two first-year Form & Visualisation modules have developed into an intricate educational framework that has managed to gain – and maintain – a meaningful position, with relatively little need for major changes.

Furthering this education, possibly in the context of a next serious overhaul of the BSc curriculum, will be in the hands of a next generation of motivated education-pioneers on the level of Form-, Drawing- and Modelling Studies!

Architecture as Petrified Music – a Tectonic Definition

Introduction

“I call architecture “petrified music” (...) the tone of mind produced by architecture approaches the effect of music” (Goethe, 1839, p.282)

Music and architecture can both be considered performing arts. Both develop from immutable and independent internal structures of their own culture and time. This apparent contradiction reveals the sensitivity to an implicit order (language) granting universality in its analyses, independent of the act of communicating (speech). Architectural history reveals as a pattern, the relationship between music and architecture, with different reinterpretations according to different epoch. This parallel is natural because both architecture and music seek for syntheses throughout a creative process of composition, as an intellectual activity.

Vitruvius was the first theoretician to make an analogy between architecture and music making reference to geometry and mathematics by relating to the concept of harmony. Lionel March (1998) states that Alberti made a convinced comparison between architecture and music, associating it with harmony through a system of ratios and geometric proportions, using composing elements of architecture, in order to achieve the Vitruvian “commensurability”. Lionel March reveals patterns within Renaissance, where can be found references to mathematics, geometry, theology, astronomy and music. The influence of Classical revisited ideas, namely Ptolemy’s treaty “Harmonic”, on the mathematical theory of music, had a strong impact on Renaissance theorists (Zarlino, Boethius, Alberti, and Palladio). In the Poetic Tectonic era, architecture as petrified music becomes a recurrent analogy referenced by prominent architectural personalities such as: Frank Lloyd Wright, Le Corbusier, Xénakis, Lionel March, Niemeyer, Louis Kahn, Daniel Libeskind, among others.

Structuralism considers that all object of study must be observed as a system in transformation, from which it can be, extracted the basic laws of structural method. In order to better understand structuralism, the classical used argument is melody, the connection with music as a universal language.

Assuming that both arts are universal languages and architecture can be seen as *petrified music*, by being a composition, it is important to understand what is the underlying lexicon to a purely structural point of view of architecture. The question imposed tries to understand from a hierarchical point of view of composing elements

of music as art, from the reduced model to the totality of its linguistic elements, the parallel towards structure in architecture. What are musical notes, scales, chords, harmonic, bar/measure, rhythm, melody and finally music, within architectural structure?

Material as Musical Note

Musical note is the minimum element of a sound formed by the vibration of air inside a specific frequency. The musical note appears as a graphical representation, a sign, dependent on culture (Roman and Anglo-Saxony language), increasing its readability in the formation of a universal language.

Considering the concept of *structure in architecture* (Oliveira, 2017), within the logic of *architecture as petrified music*, to musical notes, it has to correspond building materials. Therefore, building materials are the phonetics of architectural language. The set of materials have constructive parallel to diatonic musical scale (Dó, Ré, Mi, Fá, Sol, Lá, Si), as a set of standards “sounds” of architecture (stone, ceramics, wood, iron/steel, plastic/ textile). Each materiality has a decisive role in the physical appearance of structures for its interconnection with form, construction process and behavior. Wright (1928) about material constructive logic according to its own nature, thus referred: *Each material has its own message and, to the creative artist, its own song*”. Detailed material applications have an inherent image with its intrinsic poetic value that expresses: identity, plasticity, texture, color, and stereotomy.

Structural Codes as Chromatic Scale

In music, in order to play harmonically in any tone and by any combination of musical instruments, it was necessary to “temper” the diatonic scale. This gave rise to a new scale where every note had the same value: the *chromatic scale*. The *chromatic scale* is a scale consisting of twelve sounds, formed by seven notes of the diatonic scale plus the five intermediate tones: the semi-tones. Musical scale is an ordered sequence of tones by vibrating frequency of sounds, to which it is added harmonic regulations to *chromatic scale*. Making an analogy with music and language, it is important to realize what corresponds in structure, the harmonic rules and the semi-tones understood as *morphemes*.

According to Rebello and Bogéa (2004), “blocks”, “bars” and “blades” are invariant conceptual structural geometries along building history. By depending on its scale and proportion, these three invariants contribute directly to structural behavior. Building materials, when hierarchically rearranged according to their rigidity associated with these three reduced models (block, bars and blades), determines the structural codes. Structural codes allow for their combination, according to principles of geometric order, the various structural types in growing complexity according to their rigidity, hierarchically rearranged. This structural code, when combined, allows different “chords”, different structural types. The set of structural types forms the structural lexicon.

Block

Rebello and Bogeá consider that “block” sign is a pattern, an invariable in architectural history, regarding to its geometric application associated with specific materials such as stone and ceramics (clay blocks/adobe). Their application depending on logic of materials defines a “*morpheme*”. The sign block is characterized by a geometry in which the width, length and height have the same order of magnitude. The authors concluded that the blocks as a constructive sign (stone or ceramic) mechanically work through compression, which allows building walls, pillars and arches. The geometry of arches is what keeps the blocks in place through compression allowing structural spans.

The structural code as a product of sign (geometry) interconnected with material reveals the constructive system. Associated with stone material we can observe different types of stone work, according to stone whittle. The same pattern can be observed towards ceramics. Adobe, as variant of ceramic may be understood as continues block due to its constructive nature.

The sign block, adapted to concrete, can form a straight beam when external compression is applied to protension. This conceptual framework gave rise to a new concept of reinforced concrete bridges, called “balanced cantilever”.

Bar

The “bar” as a structural geometry sign is defined when two dimensions differ greatly from a third. This conceptual sign is comprehensive enough to range from ceramic brick, to steel cable understood as *morphemes*. Both structural codes have the same geometric DNA, depending on material and geometry. This geometric sign can allow both tectonic architecture and stereotomic architecture, regarding to its structural genesis. When the sign “bar” interconnects with a more rigid material such as stone, ceramic, and even reinforced concrete, depending on its geometry of greatest tendency to “block”, architecture will tend to have a stereotomic character. By contrast, when the sign “bar” interconnects with more flexible materials (wood, iron / steel and concrete) architecture will tend to be of tectonic genesis.

The “bar” exhibits a greater variety of structural types than “block”, ranging from a simple wall, to columns, beams, arches, vaults, domes, roof trusses, porticoes, slabs and ultimately, cable-stayed types. This connection between sign and specific material properties allows different results, which are the product of two opposing views: rigidity (column and beams, for ex.) or flexibility (cable-stayed).

Stone as a material associated with the sign bar defines the construction system visible on the stone whittle. This constructive combination allows bearing walls, columns, beams (lintels), arches, vaults and domes.

Ceramic as material gives origin to brick, as a constructive “*morpheme*”. Brick can be applied according to different whittles allowing a range of structural types such as bearing walls, columns, arches, vaults and domes. Vaults and domes are more complex variants of a primordial type: arch.

Wood as a material, interconnected with the sign bar, defines a constructive system based on woodcarving. This combination allows the construction of walls

(piling barriers), columns, beams, roof trusses, and porticoes as structural typologies.

Iron/steel as building material linked to bar sign defines its own constructive system that comprehends various metal beams with different profiles to cable-stayed systems. This combination allows the construction of supporting walls, columns, beams, arches, vaults, porticoes, spatial slabs and cable-stayed structures. Flexible bar as a sign is referred to minimum rigidity of material associated with extreme geometry of bar, and has to do with the cable concept, with different structural properties when compared to rigid bars. Cable is the opposite end within the bar range. Cable structures have no resistance to compression and bending, only reaction to tension.

Blades

Blades are signs from which there is a predominance of two dimensions over a third, allowing from flat to complex surfaces. Depending on the material to which it is interconnected it allows diverse structural types ranging from walls, to vaults, slabs, plates, meshes, membranes, and shells. Blade stiffness depends on material, form and thickness. Blades can be structured by their own rigidity, as we can see from reinforced concrete slabs. It is through the ratio of dimensions, focusing on the thickness, that blades can either be slabs or membranes, a binary relation for the same sign, with ranging possibilities.

The geometric sign blade interconnected with ceramics allows the construction of Gaussian vaults and folded plates as we can observe through the analysis of Eladio Dieste's work. This range of possibilities requires pre-tensioning.

The geometric sign blade associated with wood material allows the construction of walls (Berlin) and meshes.

Interconnected with reinforced concrete it allows walls, domes, slabs, meshes, shells and plates. Shell is an intermediate type between membranes and slabs because its structural stiffness comes from form. Shell type structures allow long spans expressing the slenderness of membranes. Rigidity and structural stability can also be obtained from bending blades.

When blade sign interconnects with iron/steel it can be detected different constructive types such as walls, slabs, meshes, shells, and plates.

Finally, the plastic / textile material associated to blade sign is visible on membrane structures. Membrane type structures use cable webs that allow traction, using double opposed geometry for structural stability (Frei Otto).

Structural Lexicon as Chord

Chord, in musicology, is the combination of two or more notes, played simultaneously according to a harmonic series. In an analogy with linguistic, we can consider that the study of phonemes, corresponds in musicology to musical scale. Chord has its correspondence with words by making a comparison with linguistics, logic combinations with meaning, referring to a sign.

Structural Lexicon (walls, beams, arches, porticoes, vaults, etc.) corresponds to the compendium of constructive types rearranged in different typologies (Fig.1). The constructive type is understood as a musical chord, a byproduct of previous

combination of basic “sounds” of architecture played simultaneously: the materials used depending on their rigidity and specific geometry.

Structural System as Harmonic

Harmony is a classical concept related to the idea of beauty, order and proportion. In music, harmonic is the field of study concerning the constitution and sequence of chords and their tonal connections, in a logical relationship. As Hugo Riemann defined it in 1884, harmonic consists on the correct organization of the tonal system, the chromatic scale, from which a series of chords are developed, forming the harmonic field, hierarchized from a set of relationships and functions. Therefore thus stated: “*La theorie de l’harmonie a pour object l’etude e l’application des lois qui régissent l’enchainement logiquement rationnel et techniquement correct des accords*”(Rieman,1884, p.1).

In architecture the notion of harmony refers to an implicit order, which Louis Kahn stated in *Order is*: “*A form emerges from the structural elements inherent in the form* (1955). This notion of form and structural system put into order refers to a relationship of synthesis between structure and architecture, related to their useful value based on logic and rationality of technique choices.

The work of Eladio Dieste is an example of economic, functional and aesthetic exploitation of architecture. Developed with a focus on (armed) brick material, it relies on a set of innovative structural solutions that harmonize with each other. It is an example of constructive expression, spatial, aesthetic and symbolic thought of architecture that seeks architectural truth. By understanding the context and its limitations it allowed space for innovation, with a focus on structural design, assuming a dual function: aesthetic and functional. Harmony as a structural system is not only achieved through the use of the same material, it can be achieved through the use of different materials with specific uses depending on their structural properties and structural intentions.

The conjugation of constructive solutions in a combinatorial process gives rise to a synthesis of material, geometry, sign and mathematics (calculus) which allows an awareness of form from its most primary structural elements, where logic rules. Harmony in its condition of structural system represents the set of choices made, linked to a prior intentionality (idea), in order to find a balance through compositional elements (types) with a view to the whole – architecture.

Span as Bar/Measure

Bar is the minimum set of times to set a beat. Bar states musical accent through time units defining musical pulse (tempo) and rhythm. Time signature is directly linked to the pulse of the music, and corresponds to the spacing between musical sounds. Bar defines metrical units, the set of beats extracted from musical rhythmic surface as it unfolds through time. It is from the choice of the bar that a particular musical style is identified because it presents a rhythmic pattern of its own. The metric coming from the bar has correspondence with dance styles and poetic metrics from the song, which allow us to understand its language.

In architectural structural terms bar has correspondence to span, the distance between structural elements in space. The distance between elements depends on structural expression intended for a given purpose. For each combination of material, geometry and form, which gives rise to a constructive type, there is a maximum span limit. The awareness of span limits taken out of any adopted structural system, allows realism in order to achieve the best structural solution.

Metric as Rhythm

The rhythm in music is associated with an idea of coordinated movement, a repetition of regular or irregular musical intervals, strong or weak, long or brief, presented in the composition. The rhythm determines the duration of each sound and also of the silences, forming sound patterns. The rhythm is decisive in musical composition. The rhythm depends on the bar, since it defines the musical accent that the notes will have inside a composition, determining what will be the speed, division and grouping of notes, which will function as a rhythmic constant.

Rhythm in architecture is visible in the repetition of elements. Structure in architecture in order to become logical has to be arranged according to a structural metric. Structure when exposed, ads rhythm from the repetition of the structural primary elements to which the secondary ones can be added. By secondary it is understood all other elements that are not structural and that form part of architecture as a whole. The spans, considered as “bars” of “petrified music”, attribute to the adopted constructive system a spacing that can be repeated by its maximum structural limit, thus achieving a harmony. However, within this range of possibilities and limitations, there are variations that allow different metrics, which can be also in harmony by being logical.

The metric translates a simplistic prior thought to solve a more complex whole, functioning as a ruler matrix. The double meaning of structure, defining a specific metric for a given purpose, attributes clairvoyance to architecture.

Physical Structure as Melody

Melody is a structural part of the whole, music, where there is a concrete definition of what one wants to express with linear development over time, not providing space for arbitrariness. Melody in musical notation is what gives sense to musical composition described in the sheet music, understood as a music project. It is represented on the staff horizontally for succession of musical notes and vertically for simultaneous sounds (chords).

Melody in architecture has correspondence to the physical structure in the form of a project, a prior logical and hierarchical though with a view to materiality. The notion that (physical) structure is an invariant of architecture calls for architects to use it wisely, opting for the elements at their disposal, the constructive lexicon. Venturi considers that new meanings can be given to the whole from the employment of already existing constructive elements. Therefore concludes that architecture as an art of creation depends for its evolution of content over materiality. Structural system by its essential condition reveals itself in architecture, as melody towards music. It is composed of a set of harmonically interrelated elements, considered determiners of

architectural form. The choice for a given structure is related to the context in which it is intended, in an intimate relationship between material - tool and process, with a view to materialization associated with the economy of means. The prior idea is translated into a project. The project is understood as the petrified sheet music.

Conclusion - Architecture as (Petrified) Music

“In musicology the architecture of a symphony can be said to be conceptual organization of its parts into a whole, its intellectual structure. It is strange that the word is rarely used in this sense with regards to architecture”(Unwin, p.13)

Architecture and music both possess a self-linguistic based on semiotics, which grants its universality (Fig. 2). Universality comes from communicating their own time through language, understood as a system of codes. Both arts as universal expressions have specific linguistic and compositional properties, a universal structure of thought and communication, associated with know-how: technique.

In order to become music, it isn't enough to read a musical composition in a sheet music, it is essential to exist an interpretation by the musician, understood by the public as such. Music as a social phenomenon presents different styles, approaches and conceptions according to the culture to which it is intended and from which it comes. Its diversity is also its wealth. For having evolved throughout history, it presents itself as a historical discipline of culture, understood as an art, which simultaneously accompanies and functions as an expression of cultural evolution of the folk. Music as an art creates the unknown from known elements, shaping the future from a representation of the present. The notion of future is related to content, what is sought to convey, therefore becoming an art of representation. Music, like architecture, can be divided into genres, styles and forms, in accordance to its origins, which is why it is classified through categories, such as: “classical music”; “popular music”; “rock music”; “folk music”; “religious music”; etc. Musical categories can be subdivided into other subcategories coming from miscegenation. They can also acquire a universal character, depending on their acceptance and understanding by various cultures. Examples of these genres are jazz, blues and bossanova.

Architecture, like music, only reaches an artistic expression when it exists, when it is interpreted in the form of matter, establishing a connection with the audience for which it is intended. In order to have materiality in architecture, it is essential to exist a structure of physical support, whose lexicon in architecture results from the combination of materials, geometry, and calculus, the “musical notes” of “petrified music”. Structure in its condition of efficiency rests on the harmony, on the logic of the connection between the various structural types, understood as “chords”, which best materialize a previous idea. It is a constant in architectural history, the technique linked to the span, which in turn is linked to the technological expression of a given period. The metric translates a common logic that organizes and structures materiality, a conceptual matrix that puts the set of structural solutions in order, aided by the rhythm through the repetition of structural elements, trying to overcome the challenges of gravity – span understood as “bar”. Architectural thought is expressed through technical drawing as a universal language, here understood, as a “composition” which

includes structural engineering (melody) transposed into the “sheet music” (project). Architecture as “petrified music”, with representative art quality, presupposes the interpretation of the various intervening elements in the work in order to grant its existence, in which the architect has to occupy the place of “conducting” and “composer”. Mies once said about tectonics that “Architecture is a language and I think you have to have a grammar in order to have a language. If you are good at that, you speak a wonderful prose. If you are really good, you can be a poet”.

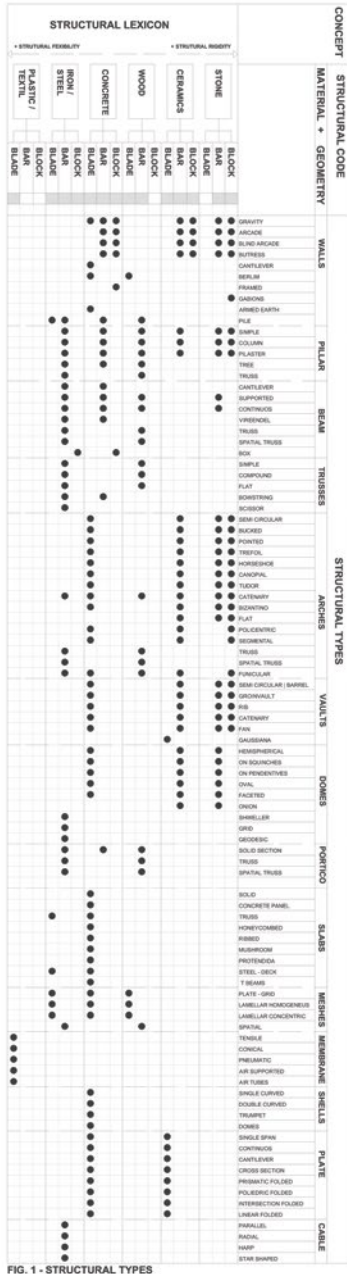

FIG. 1 - STRUCTURAL TYPES

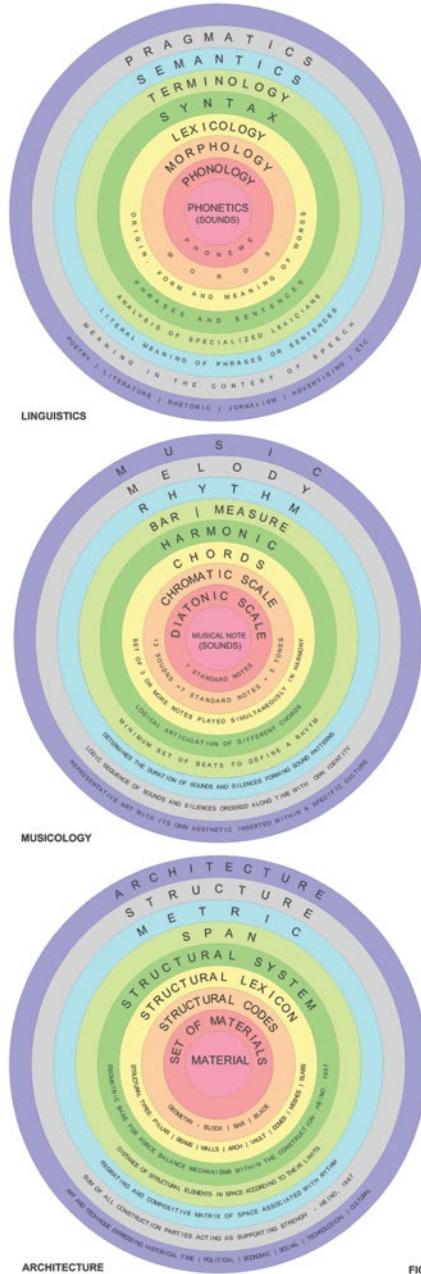

FIG. 2

Bibliography

- Blackburn, Simon. *Diccionaire of Philosophy*. Lisbon: Gradiva.1997
- Engel, Heino. *Sistemas Estruturais*. Barcelona: Gustavo Gili.1967
- Goethe Johann, et all. *Conversations with Goethe in the Last Years of His Life*.
Boston: Hilliard, Gray and company. 1839. p.282
- James J. Thomas & Kristin A. Cook. *Major Levels of Linguistic Structure*,
National Visualization and Analytics Center: Illuminating the Path.
2005.p.110.
- Kanach, Sharoun. *Musique de l'architectur, textes, réalisations et projects
architecturaux choisis*. Marseile:Parenthèses. 2004
- March, Lionel. *Architectonics of Humanism, Essays on Number in Architecture*.
Great Britain: Academy Editions.1998
- Oliveira, Filipe. *Structure in Architecture – a Tectonic Definiton in the Poetic
Tectonic age* in: Couceiro da Costa et al. (eds.), *Architectural Research
Addressing Societal Challenges*.Taylor & Francis Group. 2017.p.1129-1136
- Rebello, Yopanan & Bogeá, Marta. *Geometria dos elementos estruturais, Uma
chave para a compreensão do comportamento estrutural*. Integração ABR/
MAI/JUN. 2004.
- Riemann, Hugo. *L'harmonie simplifiée ou théorie des fonctions tonales des
accords*. London: Augener & Co.1890.p.1
- Unwin, Simon. *Analysing Architecture*. London: Routledge.1997.p.13
- Venturi, Robert. *Complexity and contradiction in architecture*. New York: The
Museum of Modern Art.1977
- Vitrúvio. *De Architectura*. Lisbon: IST Press.2006
- Wright, Frank L. *In Cause of Architecture: The Meaning of Materials -
Architectural Record*. New York: Dodge Data & Analytics.1928. p.55
<http://loves.domusweb.it/mies-van-der-rohe-architecture-as-language/#.Vros9fmLS>

Saul Golden

Built Environment Research Institute, Belfast School of Architecture and the Built Environment, Ulster University, Belfast, Northern Ireland

Cinematic approaches to mapping spatial narratives

Introduction

This paper argues that film (as a multi-dimensional mapping tool incorporating aspects of space and time) can generate deeper understandings of inhabited environments than architects' traditional hand-eye approaches alone. Eschewing a hand vs computer, or traditional versus experimental processes, as an either-or situation, the paper investigates filmic methods for recording, analysing, and communicating about urban space as complementary tools for critical investigation, and creative design skills in architecture. Methods and precedents discussed draw on pedagogic research for observing and presenting complex spatial and architectural phenomena by Maureen Thomas, along with the work of three UK-Ireland based artist-documentary film-makers: Patrick Keiller, William Raban, and Willie Doherty. Project case studies illustrate how architecture students apply learned filmic techniques to selected urban settings to explore contextual, social, technological, and aesthetic qualities that can shape contemporary environments and place-based architectural decision-making.

The paper is structured in three parts: an examination of the key concepts and precedents for combining film with other architectural mediums and mapping techniques; a discussion about the use of cinematic mapping as a multi-disciplinary methodology in the project research; and an illustrated evaluation of project outcomes and findings/conclusions using extracts from filmic outputs.

The outcomes illustrate how filmic approaches were used to foster critical spatial, socio-political, and cultural urban narratives as well as temporal spatial investigations rather than to produce more commercial or abstract outcomes in their own right. The findings suggest how students can thrive on the engaging potential of film and art-based cinematic techniques to aid more traditional analytical and communication tools. They demonstrate how cinematic mapping can provide a basis to capture and communicate the implicit attributes of early stage design that are often talked about but not effectively choreographed to show early stage processes to develop design ideas ahead of the architecture.

Conceptual Framework: Cinematic mapping and Expanded Cinema

The design projects discussed herein draw on established forms of artistic and

documentary-type filmmaking from sources outside of architecture in order to bring meaning, more than entertainment, to multi-media urban mapping. Mapping and filmic approaches in the projects aim to communicate more in-depth phenomenological understandings of place; revealing the substance, history, and meaning given to space by people – i.e., through the interpretation of lived and observed human experience. Cinematic mapping (i.e., mapping communicated through filmic narratives) is a multi-disciplinary approach to envisioning architecture, incorporating filmmaking processes to communicate qualitative aspects of urban environments as well as quantitative information in ways that are accessible to both design professionals and lay-people.

The processes and precedents for filmic observation and communication that underpin the projects share aspects of psychogeographic and Situationist approaches to urban mapping that can be read in more traditional architectural media including drawings, maquettes, site-specific installations, and photography. Cinematic mapping adds a fourth dimension, time, and –importantly – allows the use of post-production techniques to communicate meaning via multiple time-frames and viewpoints simultaneously, adopting elements of “expanded cinema,” an avant garde concept that emerged in the 1960s and 1970s to challenge traditional audience-screen relationships.¹

Precedent filmmakers: Doherty, Keiller, Raban

Key precedents include films by Keiller and Raban, who began their film-making careers in architecture and painting respectively, and Doherty, a Northern Irish video-artist. The full depth of their background and body of work is beyond the scope of this paper to discuss, however they can be seen as sharing observations on the built environment through the lens of history, politics, consumerism, globalisation and personal identity. They each focus a critical gaze on places in which they live as well as trying to engage with lesser-observed aspects of unfamiliar, even empty and undervalued, environments.

Keiller is principally known for a collection of films, *The Robinson Series* that use an imaginary narrative and narrator to focus on London - on architectural, political, and social trends related to consumerism, conservatism, globalization, and individual identity in urban society. His work, illustrated in Figure 01, combines archival footage with a pseudo-documentary style, what he calls “an attempt at some sort of hyperreality.”²



Fig. 01. Film stills from *City of the Future* and *London* by Patrick Keiller
Source: Keiller, 2007, 1992 (Cropped/combined by Author, 2017).

¹ Tate, ‘Expanded Cinema – Art Term’, accessed 25 April 2017, <http://www.tate.org.uk/art/art-terms/e/expanded-cinema>.

² David Anderson, ‘Interview with Patrick Keiller’, *The White Review*, January 2014, <http://www.thewhitereview.org/interviews/interview-with-patrick-keiller/>.

Raban's films are known for pioneering examples of multiple-screen and multi-media techniques developed as a "reaction against the fixed single screen of traditional cinema."³ Raban's work, illustrated in Figure 02, grew from an his art/painting background and evolved during the 1970s and 1980s toward a pseudo-political body of work that chronicled historical and contemporary events in an attempt to "create some meaning of the condition of the country."⁴



Fig. 02. Film outtakes from *Diagonal*, *Thames Barrier*, and *Thames Film* by William Raban
Source: Raban, 1973, 1977, 1987 (Cropped/combined by Author,2017).

Doherty's work, illustrated in Figure 03, varies from landscape to urban settings and often incorporates long focused images, filmic photographs, sometimes with natural sounds, and other with voiceovers, and layers of text and image, "which creates a sense of ambiguity and plays on the viewer's prejudices and assumptions."⁵



Fig. 03. Film outtakes from *Empty*, *Remains*, and *Segura* by Willie Doherty
Source: Doherty, 2009, 2009, 2014 (Cropped/combined by Author,2017).

Projects

Student projects employing film in studio and site-based mapping were structured over a twelve-week semester through a series of steps including pilot projects and background readings, then training workshops and film precedent studies before students were introduced to selected urban areas. Mapping work was both a collaborative and individual process, working with peers and engaging with members of the public. Pilot projects were used to gauge existing film-making knowledge/skills

³ Michael Amarger and Frédérique Devaux, *William Raban Interview*, Cinémas de Traverse (EDA Productions/Corto Pacific, 2010), <https://vimeo.com/126909408>.

⁴ Ibid.

⁵ 'Derry Artist Willie Doherty's New Work "Closure" Goes on Show at the Ulster Museum', *Derry Now*, 26 January 2017.

and to provide a basis to compare later work. Supplemental readings dealt with the theory and history of how architects can use film as a new technology to contextualise and aid the student investigations.

Initial trials: wandering sideways with camera phones

The projects began with a one-day exercise based in familiar surroundings of the students' city-centre urban campus; to map a particular, but unplanned journey over the course of an hour using only a phone based camera, and to edit the resulting video for the following day. Acknowledging the ubiquity of film-use already part of students' design work, guidance in this stage was limited to Perec's advice to those aspiring to map urban and architectural environments (from readings): "Note down what you see. Anything worthy of note going on. Do you know how to see what's worthy of note? Is there anything that strikes you? Nothing strikes you. You don't know how to see."⁶

The outcomes from the first films comprised an expected collection of video walks – sped-up or slowed down – with added musical soundtracks that matched the chosen tempo with greater and lesser success. Films tended toward the frenetic jumpy character of hand-held cameras, or toward very high and low perspectives when capturing views from a single vantage point. There were typically issues with noise distortion when ambient sounds were included. Some examples from students with more prior video experience included added graphics, outtakes, split-screens and overlays to communicate more day/night activity and to distil some qualities captured in the short window of observation.

Precedents and film-watching: lessons in the art of standing still

With the benefit, and some noted student frustration, from the first exercise the next project stages included technical workshops, led by photography and digital animation tutors to help focus on more considered uses of film and film techniques. The workshops combined with film screenings of precedent examples including Keiller's *London*, Raban's *Thames River*, and Doherty's *Segura*, seen outside of the studio – in community cinemas and in art-galleries. These films provided examples where the outcomes were not random but the result of critical observations, historical understanding, and a considered use of both camera and sound. They gave students an understanding that a successful film need not be in a rush, or require a soundtrack other than what is essential to communicate some understanding of the place and people being observed. Each example included both stillness and a poetic approach to observing everyday life – allowing the camera to linger or very slowly to pan without comment, or overlaying sound captured without distortion, or adding in a measured voice over and additional sound. They require the viewer to work and engage more to discern slight movements of wind and light, and people – revealing and editing rather than pointing out everything.

The benefit of first making mistakes then learning techniques and seeing work by the artist-filmmakers seemed to make a positive impressing when students moved to the next stage – being introduced in groups to a less familiar context in a coastal

⁶ Georges Perec, *Species of Spaces and Other Pieces*, [1974] (Penguin, 2008), 50.

village setting – a contained urban area with a documented history and clear enough morphology to allow students to concentrate on their mapping and storytelling technique.

Student experiments: taking the lessons forward

The influence of the first stages was an immediate move to experiment and try to apply different techniques without as much perceptible pre-judgement as the first films. One group of students took it upon themselves to purchase a used 8mm projector, immersing themselves in the town over a couple of days. Their example in Figure 04 draws heavily on Raban's *Diagonal*, projecting an analog square of light onto selected surfaces that is captured through the digital process.



Fig. 04. “Elmo” An MArch student experiment in expanded cinema
Source: C.Harnett, S.Ladha, L.Magee, M.McAlea (Cropped/combined by Author, 2017).

The work, illustrated in Figure 04, reveals as much as it conceals at times, framing areas of the town that relate to its life and natural environment, and areas of dereliction. The analog process is captured in real-time with digital tools in a carefully staged series of locations with only ambient noise, the ticking of the projector, and the comments of local people (unseen, watching in the background): e.g., “The thing I like about this is that it’s dark and that looks like its daytime, just a small window of daytime...it’s that one square block, that looks like a picture.”

Mapping a “narrative promenade architecturale”

In the latter project stages, focused on specific areas of the town, drawing on earlier group films as well as collective desk-based reports that included traditional areas of mapping; historical overviews, figure-grounds studies, photographic surveys, interviews, and so forth. Following reviews of the group work, the students were introduced to further theory and practice techniques for their final mapping work; what is referred to as “spatially organised narrativity” developed and published by “story-architect” and academic Maureen Thomas.⁷

⁷ Maureen Thomas, ‘The Moving Image of the City: Expressive Space/ Inhabitation/ Narrativity: Intensive Studio Workshop on “Continuity of Action in Space”’, in *Urban Cinematics*, ed. François Penz and Andong Lu (Bristol: Intellect, 2011), 281–310. Thomas previously ran a “Cinemarchitecture” workshop with MArch students at [institution redacted for paper peer-review] and one of the former participants acted as an adviser on this project.

Thomas’ work, as applied here, combines a sequenced film-based narrative to the seminal framework for mapping and analysing cities, established mid-twentieth century by urbanist Kevin Lynch as a personal urban experience through landmarks, pathways, nodes, districts, and edges. Thomas’s narrative approach connects Lynch’s spatial concept to a filmic order: exposition/equilibrium, development/disruption, climax/recognition of disruption, resolution/repair of disruption, denouement/equilibrium.⁸

Using this framework, students were tasked to hone their mapping and integrate aspects of their 2D work in a way that brought an uninitiated viewer on a journey that would link to a later design proposal in that area of the town. One student’s final work (outtakes of a 6-minute film) is shown in Figure 05, below.

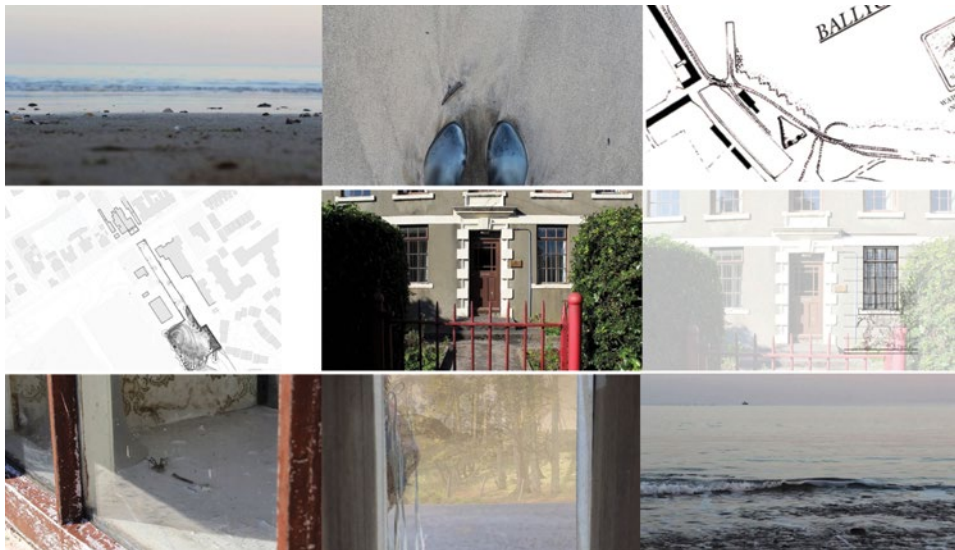

Fig. 05. Hybla – An MArch filmic journey, outtakes.
Source: L.Magee (Cropped/combined by Author, 2017).

Poetry and narrative outcomes

The student example above, one of many selected for discussion, demonstrated a significant jump in focus from the first film experiments; a more personal and matured series of observations, which in this example were developed out of the students’ initial frustration with the abstract nature of establishing a narrative without traditional architectural plans and form as the driver. The filmed example of Figure 05 takes the viewer on a journey narrated with the students own poetic prose; moving from a framed seaside perspective, using overlaid maps, drawings, and models with film, to describe a historic area of landscape and buildings with suggestions of architectural intervention.

Examples of the spoken accompaniment include the following: “On the sand where the river meets the see you’re looking towards Scotland. The endless tide

⁸ Ibid.; Kevin Lynch, *The Image of the City* (MIT Press, 1960).

is brought in an pulled back, tying two places together; a passage not an end...A sylvan avenue sets an axis to a house called Hybla, one of the oldest in the town... To turn from Hybla, and revel in earthen qualities...a moment to consider, straight stricken shadows from swaying sycamores. You stand in the cold but out of the wind and watch milky white swim with grey as the branches swing and dance against the glass...Bronze captures only the dying evening light, and you look up at the fleeting framed clouds. The smaller space is hushed awaiting its audience...Lowered toward shallow waters, you slip across to the fort side. You climb it and you reason with why it is called a cursed place. You hastily retreat. Hybla is a respite. The sea is a deep breath, and you go home.”

Summary

A considered and time-based filmic approach to mapping can reveal unexpected phenomena in unaltered everyday environments. Once observed and noted, less readily observable socio-spatial phenomena can then be captured and shared more effectively (in real or time-lapsed frequencies and frames) using cinematic techniques as communication tools. Like orthographic drawings, model-making, and CAD skills therefore, filmic methods can become another set of intuitive creative tools to aid architects’ exploration and envisioning of changing environmental meanings and experiential spatial qualities in their designs.

A recurring theme in the projects herein, derived from examples such as Raban’s *Thames River* was a more deliberate choreography or framing of two-dimensional drawings. A number of students filmed their traditional drawings in a considered way to focus and frame the intended messaging with increased specificity – aided by actual movement “through the space,” accompanied by sound and spoken word.

The mapping work was most successful when students communicated through real materials and references; less successful in communicating environmental perceptions when drawn. Some students focused more on the act of filmmaking rather than storytelling, which resulted in picturesque films that often failed to communicate intended concepts clearly; more structured narration and visual signposting to lead the reviewer through their thinking was needed.

As one external reviewer noted: “More accomplished pieces of work delivered conceptual ideas driven by a desire to make tectonic and material compositions intent on delivering specific experiences rather than ideas conceived to shape and make architectural form to be viewed. The sophistication of phenomenological intent that projects delivered was supported and enhanced by the process of capturing ideas on film.”

Conclusions

The project findings set out in the paper suggest filmic techniques can positively impact the experiential depth of design investigations, and that filmic outcomes can be effective envisioning tools that foster greater engagement between architectural professionals and lay-persons. They support an argument for the use of filmic techniques more widely in architecture, particularly for early-stage design

investigations. Structured thematic approaches to filmic mapping, drawn from established theory and precedents, provide a basis for architects to observe, test, and communicate temporal environmental qualities as spatial narratives, to move beyond two and three-dimensional surface/object fixations from the earliest project stages.

Finally, the project experience and findings demonstrate how filmmaking can provide a platform for architects and non-architects to more effectively envision and share insights about everyday spatial experiences. Though a limited study, the project shows how the impact of digital research and design tools can extend beyond a limited academic sphere of architects, filmmakers, and students.

Bibliography

- Amarger, Michael, and Frédérique Devaux. *William Raban Interview*. Cinémas de Traverse. EDA Productions/Corto Pacific, 2010. <https://vimeo.com/126909408>.
- Anderson, David. 'Interview with Patrick Keiller'. *The White Review*, 2014. <http://www.thewhitereview.org/interviews/interview-with-patrick-keiller/>.
- 'Derry Artist Willie Doherty's New Work "Closure" Goes on Show at the Ulster Museum'. *Derry Now*, 26 January 2017.
- Lynch, Kevin. *The Image of the City*. MIT Press, 1960.
- Perec, Georges. *Species of Spaces and Other Pieces*. [1974]. Penguin, 2008.
- Tate. 'Expanded Cinema – Art Term'. Accessed 25 April 2017. <http://www.tate.org.uk/art/art-terms/e/expanded-cinema>.
- Thomas, Maureen. 'The Moving Image of the City: Expressive Space/ Inhabitation/ Narrativity: Intensive Studio Workshop on "Continuity of Action in Space"'. In *Urban Cinematics*, edited by François Penz and Andong Lu, 281–310. Bristol: Intellect, 2011.

The Significance of Retaining Post-Military Barrack Complexes for the Sustainable Landscapes of Garrison Towns

Introduction

Cultural landscape of historic towns is similar to a fossil accumulating sediment from all the passing years and events. It is the record of local history and therefore the transmitter/holder of local tradition and the basis for local identity. It is linear, like a string of stories, that can only be understood properly if told consecutively in order, without omissions. Every town has its own characteristic features and structure where historic epochs are represented in a unique ratio giving proof to the periods of its greatest prosperity. Therefore it is essential for cultural sustainability that all the historic periods are represented in the cityscape according to their significance. Complexes of period architecture combined with local climatic and topographic conditions and wrapped up in a founding myth bear the *genius loci*.

Historic barrack complexes constitute a significant and substantial portion of cultural landscapes in garrison towns. At the same time, since their conception, they were withdrawn from cityscape and restricted for authorised personnel. Due to geopolitical changes and the consecutive restructuring of the army, many of them were demilitarized. Some of them were transferred to local authorities, others were sold to private entrepreneurs. This created problems of land use and reintegration. Vast patches of land that were originally excluded from civic life and developed to be self-sufficient had to be incorporated into the urban pattern. Therefore extensive settlements that have grown/accumulated on them over time had to assume new social functions: otherwise they would be threatened with demolition.

Considering the role they played in development of garrison towns, it is essential that barrack complexes are preserved, rather than razed or replaced, giving future generations the possibility of first-hand experience with historic evidence they constitute. This means that they need to be adapted. However, to sustain the qualities that initially triggered their preservation, the regeneration of such military installations should maintain their unique stylistic, typological and historic values, so that while fulfilling their new functions they keep serving as proof of history. Thus, we must define these educational values and determine how to best preserve and expose them

without limiting possible new uses of post-military facilities. This leads to a question: what does “successful” mean in terms of sustainable regeneration of post military barrack complexes?

Military complexes: the significance

Traditionally, soldiers were billeted in private homes¹, which made the initial relationship with the townspeople antagonistic. After establishing of the barracks, with the soldiers neatly stashed away and contained, gradually the relationship became warmer. Eventually military compounds became the focal point for local identity. Period postcards, showing barracks and officers’ messes alongside castles, palaces and town halls, prove their significance. The army constituted a driving force behind trade, industry and cultural development of garrison towns. Citizens appreciated urban modernisation and economic growth facilitated by the arrival of the troops as well as the prestige bestowed on them by the presence of numerous military units and high-ranking officers.

State-funded military compounds distinguished themselves aesthetically and with gauge amongst local investments, contributed to development of media and infrastructure and gave locals jobs at construction sites. Military compounds were usually placed in the suburbs or on the outskirts, where enough space was available for functionally complex compounds, accompanied by large drill squares, paddocks and shooting ranges. Townships provided the plots, infrastructure and amenities, thus facilitating urban sprawl towards the peripheries where the military facilities were situated. Growing military populace stimulated local commerce and services. The entrepreneurs quickly settled the perimeter of the barracks, setting up establishments readily frequented by the soldiers: movie theatres, cabarets, pleasantries (Lustgartens) and shops. Roads leading to military compounds swiftly became streets and received names celebrating military units that occupied them. Thus many streets in Silesian towns bore the names like e.g. *Kaserne Strasse* (Barrack Street) or marking the insignia of the unit, e.g. *Grenadier Strasse* (Grenadier Street) etc. Moreover large concentration of the military motivated high state officials to frequent visits and organizing manoeuvres, which elevated the rank of a chosen garrison. The dynamic of city life mirrored that of the army.

After the disbanding of garrisons the towns withered away and the only reminder of past glory were the stately historic army barracks. These historic proofs and media for local tradition are now threatened. The collapse in local economy caused by the relinquishment of military bases brought unemployment and serious real-estate issues. Once troops and their families vacated the barrack complexes, large city districts became “ghost towns”, as for example in Świątoszów (Lower Silesia, Poland) or Krampnitz (Germany). Unused, they attract urban decay, which diminishes their chances of revitalisation. Potential investors are reluctant to regenerate existing tissue perceiving only chance for profit in razing and new-build. Compounds are frequently partitioned. This expedites their sale, but leads to dissolution of spatial relations

¹ Lepage, Jean-Denis. *Vauban and the French Military Under Louis XIV: An Illustrated History of Fortification and Strategies*, McFarland & Company, Inc., Publishers, Jefferson. 2009

between particular objects in possession of various owners. Local governments are so eager to get the properties off their books that they are willing to meet most of the investors' demands. Complexes get extensively redeveloped, individual buildings are modified beyond any control, without attention to stylistic details and typology, losing all traces of authenticity along with historic and academic value. This needn't be the case.

Historic military complexes provide many possibilities of adaptation because they comprise of objects of diverse use: houses, offices, warehouses, chow halls, stables, armories, lazarettos, baths and watch-houses. It is possible to find them a new function, one that does not necessitate extensive changes to both structure and stylistics. As studies indicate, extending a life cycle of any historic building is inherently sustainable, even if a decline in performance necessitates adaptation. It requires less resource consumption in terms of raw materials, is less energy consuming and causes less pollution during construction². While extending a life cycle of a building is indeed ecologically friendly and economically profitable, the main factors affecting reuse of post military compounds are social. The core argument is that adaptation allows society to retain the social and cultural capital embodied in buildings, assuring social sustainability. Historic architecture grants past, present and future generations the possibility to learn history "first hand", through experiencing a tangible link to the past with its many rich historical and cultural layers. These buildings provide direct evidence of life in bygone times and assure the feeling of social continuity³. Many studies have identified attributes that make a building adaptation "successful" in relation to economy, location and land use, as well as legal, social, physical and environmental terms⁴. But what does it mean for post-military compounds, that adaptation is successful in terms of cultural sustainability? Because barrack complexes form a separate genre in architectural typology, they deserve a customized approach. Without them the cultural landscape of garrison towns becomes distorted. The successful adaptation of military barrack complexes would then be one highlighting all their most distinctive features and their connection with local community.

Military complexes: the typology

Historic army barracks were built in two periods of heightened militarism: at the end of the 19th c. and in the 1930. Their most distinctive feature is hieratic layout. They formed complete compact settlements, with closed vistas. Compounds built at the end of the 19th c. reprised the layout of the *entre cour et jardin* palaces. Buildings ran along the border of the plot, enclosing a spacious muster square in the middle. The central building had the most elaborate frontage and housed commissariat. The

² Johnstone, Ivan M. "An actuarial model of rehabilitation versus new construction of housing", *Journal of Property Finance*, Vol. 6 Issue: 3, 1995, p.7-26,

³ Wilkinson Sara, Remøy Hilde, Langston Craig. *Sustainable Building Adaptation: Innovations in Decision-Making*, United Kingdom, 2014

⁴ Douglas, James. *Building adaptation (2nd edition)*, London, Elsevier, 2006; Bullen, P.A. "Adaptive reuse and sustainability of commercial buildings", *Facilities*, 25(1-2), 2007, p. 20-31

compounds constructed on the eve of the WWII bore resemblance to the functionalist *Werkbund* ribbon development. The site was still arranged so that the array flanked a muster yard, but the buildings were rigorously arranged in alleys, usually according to the north-south axis. These features of spatial arrangement will only be visible if a given complex is complete, i.e. it is preserved in an original state, without infills and removals of buildings.

Each of the periods of intensified fortification had its own distinctive stylistics. They relied heavily on their contemporary trends, but had their own language and symbolism, discernible at first sight and conveying a clear message. They belong to the genre of *architecture parlante* - their appearance was supposed to make them stand out, emphasize their purpose. The ornamentation of the façade was usually discarded and substituted by tectonic differentiation and the use of contrasting textures and colors. Designers favored simplified historic forms in repetitive sequences, perceiving austerity as one of the qualities of a military life. Nevertheless, military compounds represent the architecture of power. While all architecture is commissioned by a specific investor and must thus suit his taste, the architecture of power is designed in such a way that it not only reflects the views of the patron, but also radiates them into the cityscape with as much impact as possible⁵. Military complexes were predominantly built by the state on plots acquired from or donated by the municipalities. Therefore neither shortages of resources nor land curtailed their appearance. Thus with all their austerity, they still remained imposing, radiating prestige, wealth and authority: with risalyths, *avant-corpse*, bay windows, side wings, protruding cornices and lavish friezes. They relied heavily on social archetypes and clichés associated with particular historic periods and utilized historicizing costume accordingly. The choice of stylistics depended mostly on familiarity. For example for the most part of the 19th c. Prussian and Austrian architects and art historians sought for the national style - born and bred Germanic - arriving at the conclusion that it was actually Gothic⁶. Thus in Prussia Gothic and Romanesque stylistics were used in most of the objects connected with administrative and military functions⁷. These Medieval references were probably also derived from their association with strongholds and fortifications. However in Spain, Italy and France Neo-Classical⁸ style was used more often. The barracks from the 1930s, aside from utilizing the guidelines of functionalist urban design, referred to familiarity and vernacularism. The buildings were much more cubic, deprived of redundant protrusions (like bay windows etc.) and tectonic elevations. They were usually three stories high, with usable attic and a cellar. They had plain elevations of either clinker bricks or matte plaster, and hipped tiled roofs with dormers. Only the entrances and windows were adorned with architectural detail e.g. symbolic decorative plaques or stucco bands around windows.

⁵ Sudjic, Deyan. *The Edifice Complex: The Architecture of Power*, Penguin, United Kingdom, 2011

⁶ Zabłocka-Kos, Agnieszka. *Sztuka, wiara, uczucie. Alexis Langer – śląski architekt neogotyku*, UWr, Wrocław, 1996

⁷ Like the Cuirassier Barracks in Wrocław Borek (Poland) or Grenadier Regiment Barracks in Legnica (Poland)

⁸ Like Antigones Barracks in Cartagena (Spain), Prati Barracks in Rome (Italy), Niel Baracks in Bordeaux (France), but also the Arsenal in Albertstadt in Dresden (Germany)

Therefore, if the adaptation is to be “successful” these stylistics and typology distinguishing barrack complexes amongst other neighborhoods must be maintained. The compounds must be preserved in their original form: contain all the buildings from the original array, with as few alterations and additions in terms of construction, materials or details as possible.

Means, goals and effects of regeneration

It would seem, that the most innocuous function that one could introduce into historic building is a museum, especially if it is thematically linked to the object. It requires little new utilities and allows for preservation of most of the original tissue. However a successful adaptation is also such that effectively reintroduces the compound into the society, either within use or across use and this often instigates extensive redevelopment, even in museums. Thus, what seems like a successful adaptation commercially isn't always successful in terms of cultural sustainability.

The most spectacular adaptation of a post-military barrack compound is MAXXI - Museum of Arts of the XXI c. - in Rome by Zaha Hadid Architects. The site for the new museum was the post-military turn-of-the-century compound of the *Caserma Montello* – the former *Carabinieri* barracks – which the Ministry of Defence, surrendered to the The Ministry of Cultural Heritage, Activities and Tourism. Since then a part of the barracks has been used as a temporary exhibition space. The design was selected among the 273 submitted to an international design competition, organized between 1998 and 1999 by the Ministry of Cultural Heritage “thanks to its capacity to integrate with the urban fabric and for its innovative architecture successfully interpreting the potential of the new institution and equipping it with an extraordinary sequence of public spaces”⁹.

The museum opened in 2010 after 11 years of construction and instantly became an architectural icon – thus the museum itself became a major item in the collection it was supposed to store. The MAXXI project even won the prestigious RIBA's Stirling Prize in 2010 for its architectural quality. However, for some critics the design did not seem so integrated with the urban fabric as much as self-referential and therefore pretentious¹⁰.

The original competition entry by Zaha Hadid proposed the construction of five new structures, that tightly packed the space inside and adjacent to the existing compound. Due to financial and administrative shortcomings, only the largest of the buildings has been realized. This basic volume is a snaking mass of concrete extrusions, up to 150 m in length. These weave together, creating dramatic voids and atria where they intersect. It encroaches upon main barrack building, fills the muster court completely and spills outwards. The main layout of the former military structure is still intelligible in the whole arrangement, however the new building does not correspond with its context at any instant. The Flaminio district, where the project is located, was developed primarily in the 19th c. in the Roman *Barochetto* style, while MAXXI presents a bleak concrete wall. To some it is a reference to grandiose Roman

⁹ <http://www.fondazionemaxxi.it/en/progetto-architettonico/> (accessed 20.03.2017)

¹⁰ <http://blog.marcanonioarchitects.com/rome-maxxi-and-maxentius/> (accessed 20.03.2017)

constructions of the past¹¹, while others argue that it fits the site in the way that it resembles pillbox bunker¹². The atmosphere of the rigidity of a barrack complex, a military facility with rigorous rules of conduct and strict schedule of activities has been subsided by frivolity and dynamicity of the new design. The spatial relations between the individual buildings in the compound as well as the compound and the outside district have also been distorted. The capacious courtyard towards which they were all facing, creating a feeling of an enclosed compact unit, has now been occupied by a voluminous structure that reversed the optics making the complex face outwards. Thus a museum, an institution designed for preservation, annihilates the tradition of the place and refuses to preserve the spirit of the site for the sake of recycling of space and maybe creating the “Guggenheim Effect” in the process¹³. However, despite international acclaim, in 2012 it even faced closure due to budget issues¹⁴.



Fig. 01. MAXXI (Rome) while being an architectural icon is rather a mildly successful regeneration

Source: *Katarzyna Bobola, wapniakiwdrodze.pl.*

The Bundeswehr Military History Museum in Dresden, while redesigned by Starchitect, answers both to the call for clear connection with the site and the exhibition. The building is symptomatic in the sense that its history mirrors that of the region. The barrack complex was first constructed in the 19th c. as the largest military

¹¹ <https://www.theguardian.com/artanddesign/2009/nov/16/zaha-hadid-maxxi-rome> (accessed 20.03.2017)

¹² <http://blog.marcontonioarchitects.com/rome-maxxi-and-maxentius/> (accessed 20.03.2017)

¹³ Bernini, Rita. “Rome and Its Museums: 1870-2010” in: *Annali d’Italianistica* Vol. 28, Capital City: Rome 1870-2010 (2010), p. 77-89

¹⁴ <http://www.archdaily.com/233629/update-zaha-hadids-maxxi-museum-faces-closure> (accessed 24.03.2017)

installation in Germany at that time. In its centre was the Classic-revival armoury, which almost instantly became an Army Museum. Prussian, Nazi, Soviet and East Germany military, utilized it consecutively. It survived the hecatomb of the Dresden Downtown in an intact state, while civilian buildings were reduced to ashes. After the German reunification the restored country had to face some ugly truths about its military and demythologize its army. As a result, the museum had to be refurbished and to this end a competition was held in 2001. The refurbishment by a winning design from Daniel Libeskind was realized in the years 2008-2011.

His redesign envisaged architect's trademark wedge of concrete and steel hacking through the stately historicizing building. Here, similarly to the previously discussed project, the museum becomes the exhibit. However, both the edifice and the biography of the architect harmonize with the general mood of the exhibition: "why people participate in and organize violence, why they conform to totalitarian thoughts"¹⁵. Indeed, the new architecture cuts through the old like a razor, splits it in two, like a conflict divides people, like a military incursion that comes unexpectedly for the oppressed. It also seems to resemble the history of Dresden pre- and post- the firestorm. Its abruptness symbolizes a sudden blow delivered treacherously in the back by a hidden foe.

A specific history of Australia bore yet another type of barrack complex – a penitentiary facility with rigorous rules, where by being subdued to strict military rigors and routines, offenders were rehabilitated and resocialized under military supervision. One of the oldest in the genre are Hyde Park Barracks in Sydney. Built in 1819 according to plans laid out by a convicted architect, Sydney barracks comprised of a Neo-Classical three-story edifice and a spacious muster yard, walled out from the cityscape, accumulating various perimeter buildings in the process. The complex also encompassed the 1816 general hospital for convicts and the surgical staff lodgings. After it was no longer viable as a convict administration hub, it accommodated female immigrants, entering their new life in the colonies, destitute and aged women and later courtrooms and legal offices, while hospital was turned into a mint and a bullion office. Over the decades the complex accumulated many new peripheral buildings. In the 20th c. the complex faced demolition, but when significant public personae spoke in favor of preservation, it was decided to turn it into a museum.

Today the museum housed in the Mint and the Hyde Park Barracks offers a wide variety of activities: from educational to leisure and dining. The barracks have been turned into a "living museum" with the exposition built to allow for first-hand experience. Original building tissue: lime-washed bricks, floorboards, roof timbers, doorways, paint and plaster create the mood and show the layers of adaptation accumulate through the decades. In this setting dormitories were filled with replicas of period hammocks and the chiming clock that take you back to the time when the building housed convicts and disadvantaged women. These are not just a setting. Visitors are encouraged to don carefully replicated convicts apparel and climb into the hammocks to immerse themselves in the experience. Another part of the exhibition

¹⁵ <http://edition.cnn.com/2012/09/24/world/europe/great-buildings-daniel-libeskind> (accessed 24.04.2017)

are the multimedia: searchable databases divulge the names and identities of some of the barracks inmates¹⁶.

In 1997 the complex of the Mint and its surroundings were regenerated according to a design by Francis-Jones Morehen Thorp architectural office. Redevelopment integrated contemporary architecture with carefully preserved historic buildings. The modern part of the complex houses Sydney Living Museums¹⁷. The historic courtyard is now open daily, free of charge offering a quiet retreat. There is also a café to enjoy a drink or a meal in the company of Australia's oldest surviving public building. The former Mint also houses a library and a museum. Visitors can explore the rooms and hallways where colonial surgeons and apothecaries once lived and examine the archaeological remains of the Mint in the courtyard and rear buildings, the underground machinery shafts, original roof structures and prefabricated cast-iron frame. All the strata of historic evidence and facts are readily accessible to the public.

Adaptation of Collins Barracks in Dublin (Ireland) for National Museum of Ireland – Decorative Arts and History represents a model solution for sustainable barrack regeneration. The compound is believed to have been the longest-serving barrack complex with the construction dating back to 1704. The compound encompasses three large courtyards and two auxiliary squares delineated by ascetic, granite-faced buildings. After it was vacated in 1994 it was taken over by the National Museum of Ireland and turned into a museum. The main exhibition rooms are housed in the vast halls of the soldiers' dormitories encompassing Palatine Square. These provided much needed exhibition space and flexibility in adaptation. Apart from some adjustments in interior design, the only alterations to the complex were cubic glass infills, designed by Gilroy McMahon¹⁸, allowing for uninterrupted flow of visitors between expositions, while granting better supervision and security to the collection. The appearance of the complex gives clear proof of its history and purpose and is preserved in a state allowing for scholarly examination. Moreover the exhibitions are thematically linked with the typology of the building and its historic background and even the website of the museum gives extensive information on the history and architecture of the compound.

Barrack complexes are optimal for housing educational institutions. The central courtyard can be used for leisure or sports, while peripherally situated buildings create intimacy and separate it from the bustle of the city. It is easy to create classrooms. Buildings are usually three bay, with spacious dormitory rooms on both sides of a wide corridor. However their suitability doesn't protect them from extensive redevelopment.

The *Caserma Bligny* in Savona (Italy) is a 20th c. barrack complex. It was a scattered collection of dormitories and administrative buildings, complete with workshops and a mess hall, flanking a courtyard. Archive photographs show the buildings adapted and rebuilt by the army up to a point where the original stylistics was obliterated. In the early 1990s the municipality obtained the demilitarized complex with the intention

¹⁶ <http://sydneylivingmuseums.com.au/2014/06/26/hanging-hammocks> (accessed 24.04.2017)

¹⁷ <http://sydneylivingmuseums.com.au/stories/mint-transformed> (accessed 27.04.2017)

¹⁸ <http://www.gilroycmahon.com/projects/cultural/museum.htm> (accessed 27.04.2017)

of creating a branch of the University of Genoa. In agreement with the local Chamber of Commerce the barracks were then turned into a vocational school. The new campus was designed with the use of existing buildings by 5+1AA architecture agency. The architects envisaged the creation of shaded *piazettas*, achieved through construction of large treillages¹⁹. The pillars that support them create an intricate borderline of a transitional area between the interior full of serious lecture rooms and the exterior for leisure. The design was based on the concept of stoa: open-air room for discussion.²⁰ The array was supplemented with student houses. Works begun in 1997 and the campus was completed in 2001 and in 2003 it was nominated to European Union Prize for Contemporary Architecture²¹. Apart from the regeneration efforts the campus seems like a comfortable place to study. While the concept of an open air academia complete with accommodation is welcome, the regeneration effaced the spatial disposition of the complex and did not return to historic stylistics. The new outlook is favorable for the youthful users and perhaps is the most humane treatment for a complex that was so heavily disfigured. Nevertheless one would never have guessed the origins and primary function of the complex, not to mention the website, which remains mum on the subject of the campus' origins.

Cartagena (Spain) also boasts a student-oriented modern campus in regenerated Barracks of Antigones²². The buildings come from the 18th c. and were built to house the troop securing strategic port in Cartagena. The buildings were demilitarized in 1996. An effective adaptation allowed Polytechnic University of Cartagena to take residence in the barracks in 2005. The original edifice from the 1780s was composed of a *corps logis* with two side wings encompassing a courtyard. Nearly 100 years later, the buildings were fitted with an arcading which run in two levels along the courtyard and morphed in a fourth wing: a covered two-story walkway. Architects who provided the designs for regeneration, Martín Lejarraga and Fulgencio Avilés²³, replaced the 19th c. extension with a modern structure, spacious enough to house didactic rooms, with austere, neutral elevations to fit the military aesthetics. The historic elevations were restored while the three-bay wings were fitted with classrooms on both sides of a multipurpose hall and the basement under the courtyard provided space for climate-controlled laboratories. The historic function of the barracks is evident and unthreatened by the addition of the new wing. The modern architecture bears no historicizing features, it is utterly contemporary, but corresponds with the historic buildings by its asceticism and rigor.

¹⁹ <http://www.floornature.com/5-1-chaix-morel-conversion-of-bligny-barracks-into-a-university-campus-italy-1997-4310/> (accessed 24.04.2017)

²⁰ <http://www.5piu1aa.com/it/2011/08/residenze-universitarieavona/> (accessed 27.04.2017)

²¹ So called EU Mies award, <http://miesarch.com/work/918> (Conversion of Former Barracks to New University Campus & Multipurpose Business Centre)

²² <http://www.teleco.upct.es/index.php?id=13> (accessed 27.04.2017)

²³ <http://www.lejarraga.com/en/?portfolio=rehabilitacion-del-cuartel-de-antigones-universidad-politecnica-de-cartatena-upct-biblioteca-general#!prettyPhoto> (accessed 24.04.2017)

Conclusion

Barrack complexes are the landmarks of the cultural landscape in garrison towns, a tangible link to their history and explanations for the way they developed. They carry the *genius loci* of the cultural landscape of garrison towns. Fortunately, military installations allow for introduction of diverse functions during regeneration. However, while an adaptation may reintroduce the object into active participation in the society, it may also eradicate all historic and sentimental values. The regeneration must then not only be economically beneficial, but culturally sustainable.

Bibliography

Books:

- Lepage, Jean-Denis. *Vauban and the French Military Under Louis XIV: An Illustrated History of Fortification and Strategies*, McFarland & Company, Inc., Publishers, Jefferson. 2009
- Douglas, James. *Building adaptation (2nd edition)*, London, Elsevier, 2006
- Wilkinson Sara, Remøy Hilde, Langston Craig. *Sustainable Building Adaptation: Innovations in Decision-Making*, United Kingdom, 2014
- Zabłocka-Kos, Agnieszka. *Sztuka, wiara, uczucie. Alexis Langer – śląski architekt neogotyku*, UWr, Wrocław, 1996
- Sudjic, Deyan. *The Edifice Complex: The Architecture of Power*, Penguin, United Kingdom, 2011

Paper in journal:

- Johnstone, Ivan M. “An actuarial model of rehabilitation versus new construction of housing”, *Journal of Property Finance*, Vol. 6 Issue: 3, 1995, p.7-26
- Bullen, Peter A. “Adaptive reuse and sustainability of commercial buildings”, *Facilities*, 25(1-2), 2007, p. 20-31
- Rudnicka-Bogusz, Marta. “The architecture and spatial disposition of 19th - and 20th century military building complexes in Silesia. Typology, design, regeneration – preliminary study” in: *Architectus*, 2/42, p. 19-30, 2015
- Bernini, Rita. “Rome and Its Museums: 1870-2010” in: *Annali d’Italianistica* Vol. 28, Capital City: Rome 1870-2010 (2010), p. 77-89

Website:

- <http://www.fondazionemaxxi.it/en/progetto-architettonico/> (accessed 20.03.2017)
- <http://blog.marcantonioarchitects.com/rome-maxxi-and-maxentius/> (accessed 20.03.2017)
- <https://www.theguardian.com/artanddesign/2009/nov/16/zaha-hadid-maxxi-rome> (accessed 20.03.2017)
- <http://blog.marcantonioarchitects.com/rome-maxxi-and-maxentius/> (accessed 20.03.2017)
- <http://www.archdaily.com/233629/update-zaha-hadids-maxxi-museum-faces-closure> (accessed 24.03.2017)

- <http://edition.cnn.com/2012/09/24/world/europe/great-buildings-daniel-libeskind> (accessed 24.04.2017)
- <http://sydneylivingmuseums.com.au/2014/06/26/hanging-hammocks> (accessed 24.04.2017)
- <http://sydneylivingmuseums.com.au/stories/mint-transformed> (accessed 27.04.2017)
- <http://www.gilroymcmahon.com/projects/cultural/museum.htm> (accessed 27.04.2017)
- <http://www.floornature.com/5-1-chaix-morel-conversion-of-bligny-barracks-into-a-university-campus-italy-1997-4310/> (accessed 24.04.2017)
- <http://www.5piu1aa.com/it/2011/08/residenze-universitarieavona/> (accessed 27.04.2017)
- <http://www.teleco.upct.es/index.php?id=13> (accessed 27.04.2017)
- <http://www.lejarraga.com/en/?portfolio=rehabilitacion-del-cuartel-de-antigones-universidad-politecnica-de-cartatena-upct-biblioteca-general#!prettyPhoto> (accessed 24.04.2017)

The Virtual / Physical Equilibrium

Introduction

Two decades ago, during the 1997 EAEA conference in Delft, hands were counted whether the EAEA should focus on the envisioning of physical or digital models. At that conference the count was almost equal, but we foresaw a trend that soon architects would only make use of digital models.

Actually those early days of virtual city models, collaborative virtual environments and ‘VRML’, were at a high in 1997. VRML (Virtual Reality Modelling Language), ‘the HTML of spatial content’, was designed for the future. The VRML Cosmo Player web plugin was capable of rendering a virtual model at 20 frames per second in a ‘huge’ 640 by 480 pixels textured perspective view.

A decade later, in 2007, there was much more scepticism about digitally rendered imagery. VRML became a file format for making colour 3D prints and the focus changed to making tangible models by using Computer Aided Manufacturing techniques. The ‘maker movement’ was getting into gear, while rendering had become a bit of a cliché representation method. Meanwhile corrugated cardboard remained my preferred material to quickly make sketchy ‘interactive’ scale models.

At the present moment a revival or even a breakthrough is going on, again in the field of the digital models and digital modes of representation. 2016 has been a year full of news about Virtual- and Augmented Reality (VR & AR) and we can expect this trend to carry on for a while. Google recently gave ‘Cardboard’ a different meaning, now it’s the name of a cheap VR viewer and Daydream is Google’s platform that extends Cardboard with a number of controls and standalone functionality.

We have come full circle. Virtual Reality gets practical while at the same time we value physical models and prototypes for their tangible and direct qualities. The divide is over and in this paper we would like to discuss a possible Virtual / Physical equilibrium.

We will start with a brief discussion about the different configurations in which models and media relate to the mind of the architect and the contextual fit of a design in the ‘real world’. From that overview of configurations we continue the paper with practical examples from our education experiments, in particular a MOOC (Massive Open Online Course) on Models in Architecture.



Fig. 01. Word cloud enquiry among 160 'Models in Architecture' MOOC participants.
 Source: Martijn Stellingwerff, DelftX: Spatial101x Models in Architecture, 2017.

Best of Both: Virtual & Physical Worlds

How can Virtual and Physical models go hand in hand? Both techniques inform the architect, both give insight and overview. Both can be used for expression of ideas and both can be evocative. But what particular type of model and medium does it's job best during what particular stage, and for what particular purposes can they best be employed in the design process? That is one of our major research questions on the long run.

A broad range of 3D printing techniques allows us to convert virtual models into physical artefacts and, in the other direction, by scanning, CAD and photogrammetry, to convert physical aspects into a digitized form. Does the designer get insights during the processes to convert the model from the one into the other form, or is it the final result – the physical or the digital model – that provides the insights?

Mind, Media/Models and Reality

As briefly mentioned in the introduction, Virtual and Physical representations seem to have a relatively long trend cycle in which they alternatively thrive and wither. However, at the moment there seems to be an equilibrium; both seem to coexist in many sorts of interesting configurations.

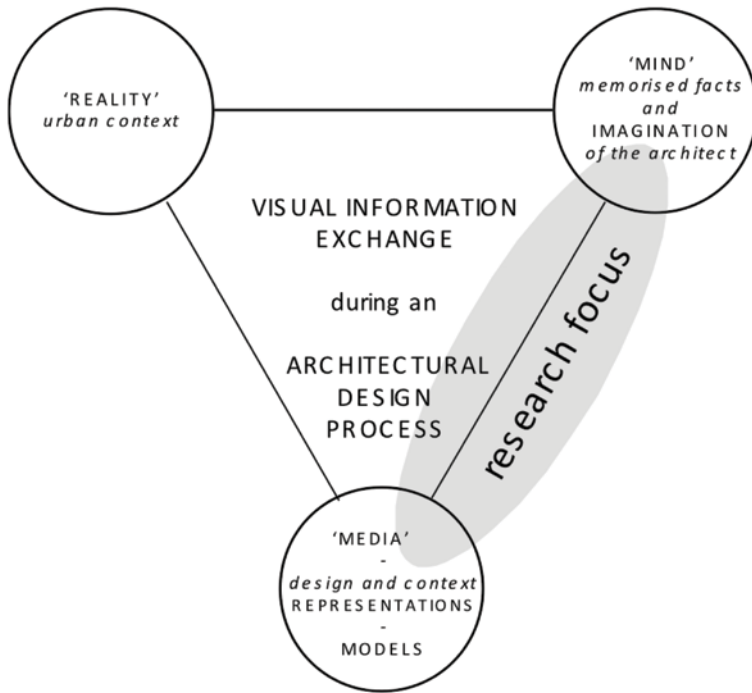

Fig. 02. scheme from the 'Virtual Context' thesis.
 Source: Martijn Stellingwerff

To describe these configurations an old scheme from my PhD research (Stellingwerff, 2005) will be useful. The scheme from my thesis (figure 2) uses three cornerstones to confine the triangular field: *reality* (the urban context), *mind* (the architect's imagination) and *media* (contextual and design representations).

In order to describe current and future configurations new versions of the scheme were created. In these schemes (figures 3,4,5), I replaced the word *media* with *models*. Both Physical and Virtual models apply. This change of words is just practical although the word *media* covers a larger field. But the word *models* is used because practically all spatial media start with models, while video, images and real time renderings in VR, AR or MR (Mixed Reality) applications are derived from such models.

Let us explore and illustrate three times two configurations.

Multimedia versus Digital Design

From roughly 1985 till 1995 the term Multimedia (figure 3 left side) was used for workflows involving images, models, mock-ups, simulations etc. to express design, to communicate it and to further explore it in many ways. Although Multimedia still exists and although it is still an attractive and creative amalgam of means, the trend to fully work digitally is prominent. Roughly starting in 1995, we can see a trend that leads to e.g. BIM (Building Information Models) in which creative physical model-making is not regarded as a feasible working method. The full digital design approach benefits from the digital characteristics: sharing, online, and re-use of data (figure 3 right side).

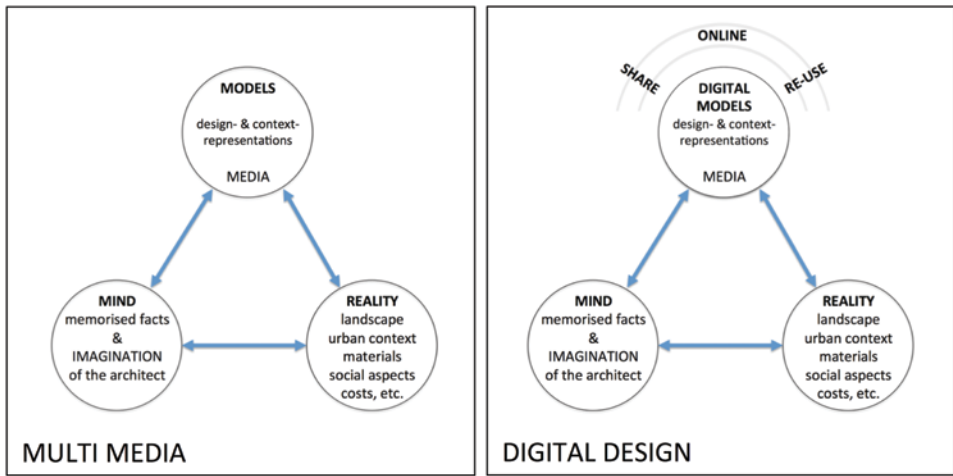

Fig. 03. Multi Media versus Digital Design.
 Source: Martijn Stellingwerff, 2017.

Virtual Reality & Mixed Reality

While Digital Design replaces physical media by digital representations, Virtual Reality goes a step further and also excludes the ‘Real World’. The designer is fully immersed and the scheme (figure 4 left side) shows this by fencing the real world off.

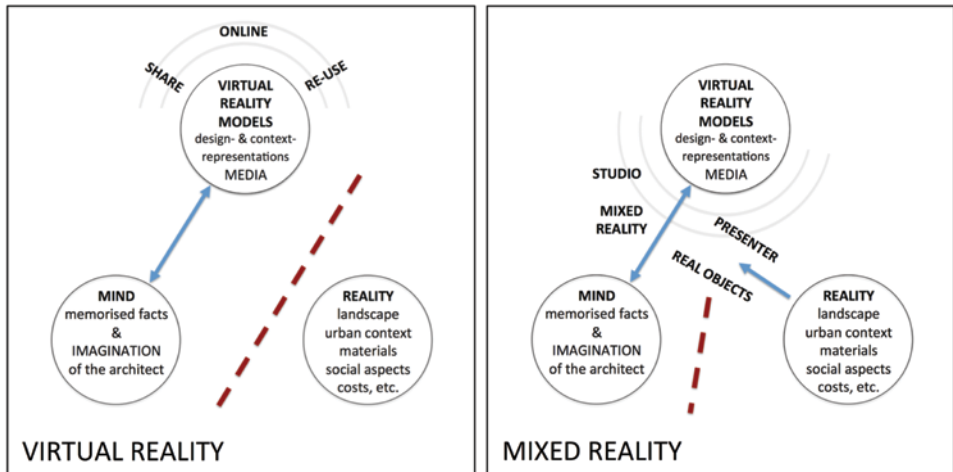

Fig. 04. Virtual Reality & Mixed Reality.
 Source: Martijn Stellingwerff, 2017.

Of course the real world still exists, but in VR it can only be experienced as a representation. Therefore VR can be seen as the ultimate representation, while the preceding trend of separation from the building site and other real things started long ago with the invention of drawings, notes, pictures, scale models, maps and contextual models. Mixed Reality (figure 4 right side) can be seen as a bit of a phony compromise

to have Virtual Reality in Multimedia representations. We use it for example in MR feedback videos for our MOOC. Such videos show ‘what it is like to be in VR’ while you look at a VR gamer or presenter on e.g. YouTube (see the two YouTube website references at the end of this paper).

Full Reality versus Augmented Reality

The final two configurations that we would like to compare using the scheme are Full Reality (FR) and Augmented Reality (AR). Full Reality is when we leave our phone and other devices home and we go out without any other media. It is almost unimaginable, just being there without even the urge to note things down and without taking a picture. It has become so special that some people need the word ‘mindfulness’ to describe the state in which we just be within the real world. It is remarkable that the trend of mindfulness emerges in parallel with Augmented Reality in which the models-world is placed between our mind and the real world. To make this even more worrisome or fascinating, we can think about the unstoppable ubiquity of screens. The cinematic big screen changed into a TV screen, a pc screen, a tablet screen, a mobile smart phone screen a VR or AR headset screen, a contact lens, an implanted artificial retina and an Occipital Bridge (name of an AR headset). The trend is obvious: smaller, closer to the eye, in the eye, into our visual processing lobe in the brain.

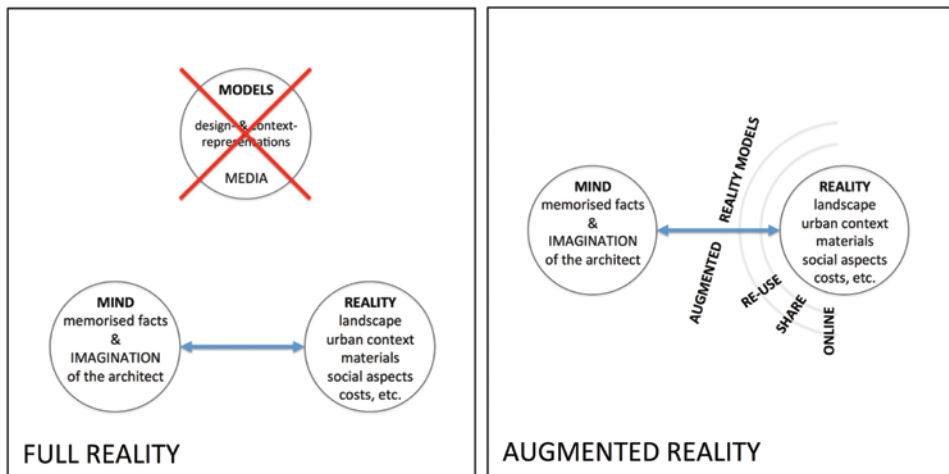

Fig. 05. Full Reality versus AR, Left: ideal from the past. Right: ideal for the future.

Source: Martijn Stellingwerff, 2017.

Application in a MOOC

The described schemes of different configurations of the designer’s mind, models / media, and the real world have always inspired me to explore different set-ups for design research and education. The interplay between digital and physical media and models has always intrigued me and the apparent revival of VR in equilibrium with the many other trends and phenomena is fantastic. This triggered me to develop an

online course on Models in Architecture.

The MOOC will run during six weeks, starting for the first time in May 2017. The MOOC gives a broad overview of possibilities and uses of models, balancing theoretical and practical issues. The course will be focussing on learning by doing, which proved to bring excitement and progress in the skillset of the active participants of a previously MOOC on Images, the “Models in Architecture – design through physical & digital models”.

- The MOOC has the following general aims:
- To provide an overview of technical methods and means, relevant to education at technical universities and for creative professions.
- To let people use models to further develop their creative skills. To lower perceived and existing thresholds.
- To make current knowledge explicit and online available to students.
- To extend institutional knowledge about creative online education.
- To match online collaboration practices in the AEC industry with online education practices.
- To provide sense of presence of online persons and design representations.
- To provide an online design studio feeling instead of an online classroom feeling.
- To prepare reusable course components for future online education and flipped classroom instructions.

The following weekly sub-themes will be covered with examples, knowledge checks, and a weekly assignment in which a 3D physical or digital model will be developed:

- Form and Space
- Scale, detail and context
- Material, meaning and dialog
- Models OF / Models FOR
- Virtual- / Augmented- / Mixed- Reality Models (VR, AR, MR)

Although some of the techniques in the MOOC are very advanced, we will still let every participant have practical experiences. We will bring a mix of course lectures in which the more expensive techniques are shown while the participants can experiment with similar but free or very cheap versions of those techniques.

We collaborate with the universities’ New Media Center to develop and experiment with new recording techniques including Mixed Reality and 360° feedback videos that will provide new experiences in the course. Google Cardboard and a number of 360° recording and scan apps will be used to also let all participants get hands on experience.

We will make use of an image and model repository to make both the physical and the digital models available to the MOOC participants. This platform, ‘sketchfab.com’, will also be used to let the participants upload their assignment work.

It was a deliberate choice to not include *either* physical *or* digital models in the MOOC. The *combination of the two* makes, in our view, this course interesting.

The equilibrium of both techniques also directs towards provocative questions and challenges. How would it be, for example, if walls in VR get the expression of cardboard (like some sketch scale models do) and what do we gain when we can 3D scan the peel of an orange (or other inspiring forms and objects) and scale it up to huge dimensions in the VR world. What if we apply Augmented Reality techniques to enrich the view from a scale model? Etcetera. There is a lot to explore and at the EAEA conference, we hope to present rich examples and insights from the first MOOC run. Figure 1 gives an early result from an enquiry within the MOOC and here you can find student results from week 2: https://sketchfab.com/search?q=tag%3Aspatial101x&sort_by=-likeCount&type=models.

Finally, the online course will also bring insights for our campus education. We hope to improve campus education by providing the students with more online examples of digitized physical models and digital models.

The paper had to be handed in before the end of the course, so the paper presentation at the conference will add the further insights and we intend to show findings and results from participants during the conference.

Bibliography

Books:

Stellingwerff, Martijn. *“Virtual Context”*. Delft University Press, Delft: 2005.
<http://repository.tudelft.nl/islandora/object/uuid%3Ace0909fb-ffc3-4761-a36e-5c611e218dd1?collection=research>

Websites:

<https://www.edx.org/course/models-architecture-design-through-delftx-spatial101x> (accessed 19.05.2017).

https://sketchfab.com/search?q=tag%3Aspatial101x&sort_by=-likeCount&type=models (accessed 19.05.2017).

Here you find an example where we discuss a number of 3D models in VR/MR: <https://www.youtube.com/embed/-2lM1peCpb0?rel=0&autoplay=1> (accessed 19.05.2017).

Mixed Reality MOOC intro trailer video: <https://www.youtube.com/embed/ftS5XnG90mM?rel=0&autoplay=1> (accessed 19.05.2017).

Interpreting Visualisations

Introduction

Public Inquiries are now common place to permit the review of sensitive development proposals in increasingly scarce landscape settings. Much of the review time centres on the visual impact since rural populations have to live cheek by jowl with the resultant structure. Recent decades have seen great advances in the quality and realism of the visualisations prepared for assessment. Equally, industry guidance and standards have developed methodologies and procedures to ensure as comprehensive an assessment is undertaken as possible. However, photomontage based visualisations appear to be still prone to error and qualitative written judgements about the likely visual impact associated still provide a contentious forum at Inquiries. Taken together these factors continue to mask a deeper understanding in visual assessment and can therefore lead to poor interpretation of images which in turn has the potential to misinform and regrettably misguide decision makers.

Difficulties

In 2012, I was asked to assist a community group in the visual assessment of a proposed extension to the Black Law wind turbine development (Phase 2) in the central belt of Scotland. The development is now complete and I have been able to revisit the visual impact evidence originally submitted to the Public Inquiry and compare it with the reality of construction over recent months. Two key issues have emerged.

Firstly, the visibility of the Phase 2 turbines is greater than predicted in some of the original visualisations. Largely, this is due to particular viewpoint locations which do not show the original wind turbines in the view and therefore lack any helpful positional control points. These views tend to be in the lee of hillsides and unfortunately in populated areas. The more open and long distance views do not suffer from the lack of positional control features and appear to be fairly accurately represented in the developer's photomontages. Accurate visibility prediction remains a difficulty, especially in the more sensitive areas of the landscape where the topography is more shaped and the development is likely to be in closer proximity to population centres. Further examination of accuracy in photomontages is a separate and ongoing research exercise and not pursued in this paper.

Secondly, the qualitative visual impact judgements for the most contentious views have been re-examined and are presented here for discussion. (Fig.01) shows a view of the recently constructed turbines in the foreground set against the original turbines in the background. This view was assessed by the developer's landscape and visual consultant at the time of the Inquiry as having 'scale similarities' with the original turbines; and that the overall visual effect will become 'not significant, neutral'¹.



Fig. 01. & Fig. 02. View from A71 (Left) and from Hartwood (Right) of Phase 2 turbines with original turbines in the background.

Source: author

Other views, such as shown in (Fig.02), were also similarly assessed.

These visual assessments were qualitative judgements based on the existing procedures for visual assessment², enshrined in the UK. You may agree with those assessments. Interestingly, the landscape architect acting for the local Council, who were the principal objectors at the Inquiry, took a directly opposing opinion. His consideration was that the views contained wind turbines that were 'out of scale'³. The Inquiry was further presented with quantitative evidence, (Fig.03), to illustrate that the scale comparisons between the existing and proposed turbines were up to 2.53 times higher.

Throughout the developer's evidence, scale comparisons of up to 2.53 times higher structures were variously dismissed as having: 'visual and contextual integration', 'scale similarity', 'adjacent turbine size is linked by perceived scale', 'not overbearing or overwhelming'⁴. There was a great leap of judgement from the visualisations presented to the subjective conclusions. It is difficult to imagine how such conclusions were reached. However, reached they were; and sitting within the framework of a full visual study with extensive visual evidence by way of photomontages and the

¹ Scottish Power Renewables. *Black Law Windfarm Extension Phase 2 Addendum*. Chapter A6, page 5.

² Landscape Institute and Institute of Environmental Management and Assessment. *Guidelines for Landscape and Visual Impact Assessment*. 3rd Edition.

³ Bayou Bluenvironment. *Report on behalf of North Lanarkshire Council on the Landscape and Visual Impacts of the Proposed Black Law Wind Farm Extension Phase 2*. Pages 15 and 16.

⁴ Scottish Power Renewables. *Black Law Windfarm Extension Phase 2 Addendum*. Chapter A6, pages 1 to 9.

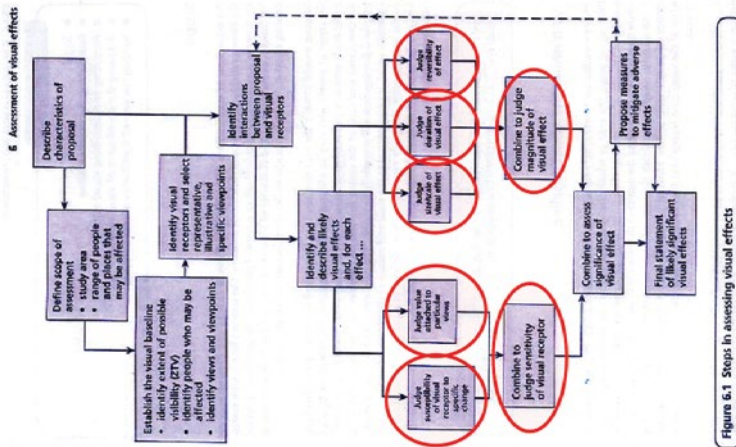

Fig. 04. UK guidelines for Visual Assessment with judgment stages circled red by author.

Source: *Guidelines for Landscape and Visual Impact Assessment*.⁵

Thinking

Visual characteristics or descriptors were first assigned by Aylward and Turnbull⁶ to visual assessment work in 1978. These descriptors formed the basis for more detailed visual examination and modelling at the time, but fell out of favour as more realistic visualisations became the norm during the 1990s and 2000s. In some ways, this has led to a lazy approach to visual assessment and an increasing reliance on simple professional judgement of images and photomontages. There is a need to improve our understanding of what we are looking at and how we associate meaning to what we see. A framework for visual perception and a progressive revelation of meaning is illustrated in (Fig.05).

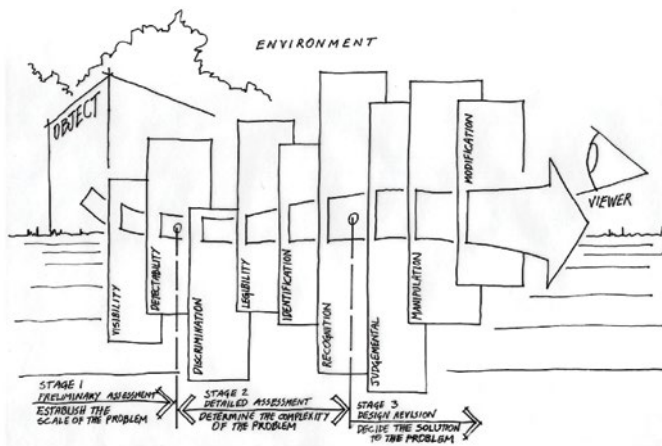

Fig. 05. The process of Visual Perception in architectural design. Source: author

⁵ Landscape Institute and Institute of Environmental Management and Assessment. *Guidelines for Landscape and Visual Impact Assessment*. 3rd Edition, page 99.

⁶ Aylward, Graeme and Turnbull, Mark. 'Visual Descriptors'; *Design Methods and Theories Journal*

The various stages are noted as:

Stage 1: Preliminary Assessment: Establish the scale of the problem

- ***Visibility.*** Determining whether or not it is physically possible to see the object. This is commonly understood as inter-visibility.
- ***Detectability.*** Is there any stimulus pattern from the object present in the viewer's field of view, i.e. can the viewer detect a change in the visual scene? (Author looking at possible components called *visual trend*, *visual redundancy* and *visual acuity* (using % steradians in the visual field of view) in this section.)

Stage 2: Detailed Assessment: Determine the complexity of the problem

- ***Discrimination.*** Can the object be discriminated from its background or adjacent surfaces in terms of its brightness or figural unity? (Author looking at possible components called *visual absorption* and *visual patterning* in this section.)
- ***Legibility.*** Can the stimulus pattern of the object be read and understood? This task requires the observer to seek some meaning in the object. (Author looking at a possible component called *visual definition* in this section.)
- ***Identification.*** The viewer seeks to bring detailed meaning to the object by identifying critical features and attributes, e.g. edge.
- ***Recognition.*** The coalescence of discrimination, legibility and identification whereby the viewer considers whether the object is recognisable from past experience. The introduction of something new to a scene creates visual tension and completes recognition. Here, the designer can fully understand the image and move towards the next stage, judgement. (Author looking at a possible component called *visual scaling* in this section.)

Stage 3: Design Revision: Decide the solution to the problem

- ***Judgement.*** Having recognised or understood the object, the viewer is now required to exercise some critical assessment of its visual qualities and character in the environment. (Author looking at possible components called *visual capacity* and *visual saturation* in this section.)
- ***Manipulation.*** Within the context of architectural design, this stage permits the designer to adjust the features or character of the object to improve visual acceptability.
- ***Modification.*** Within the context of architectural design, this stage permits the designer to modify the form of the design to improve visual acceptability.

These components of visual perception present the process of visual assimilation in a more engaging and meaningful way, seeking tentatively to explore those objective visual elements that may help to unlock the basis of subjective judgements. (Fig.06) shows a visual assessment taxonomy for the critical stages of discrimination, legibility and identification. The visual descriptors in the matrix are the informants to the task of recognition.

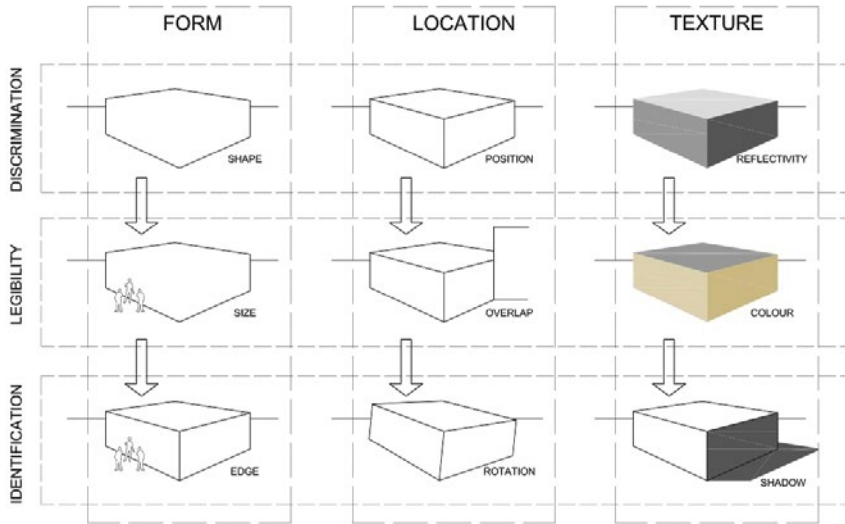

Fig. 06. Visual assessment taxonomy in architectural design.

Source: author's sketch.

The author has devised simple mathematical routines for the assessment of some of the visual descriptors outlined in (Fig.06) and these are the subject of ongoing case study applications to explore the potential of quantitative measures placing meaning on visualisations while guiding and informing those making qualitative visual judgements.

Conclusion

Current industry guidance in the field of visual analysis has been well developed over recent decades. However, despite a plethora of techniques and methodologies, it is still too common for diametrically opposing views to be held by participants at Public Inquiries. This paper has attempted to identify the framework to assist a deeper understanding of how and what we see, and how we might associate meaning to it. In exploring some of the key aspects of visual perception the aim is to help re-establish a basic and commonly accepted visual vocabulary.

The future will be to continue to unlock quantitative aspects of our visual experience to inform and correlate with our qualitative judgements; that may be a long way off, but the challenge is to use digital visual analysis to assemble the components of a quantitative assessment process. It is more than likely that we will never find a common mechanism for interpreting or associating meaning to images, but that does not preclude an attempt to start the journey.

Bibliography

Books:

Landscape Institute and Institute of Environmental Management and Assessment. *Guidelines for Landscape and Visual Impact Assessment*. 3rd Edition. Oxon: Routledge. 2013.

Purdie, Cameron. *Computer Aided Visual Impact Analysis*. PhD Thesis. University of Strathclyde. 1983.

Publications and documents without author:

Scottish Power Renewables. *Black Law Windfarm Extension Phase 2 Addendum*. Glasgow. 2012.

Bayou Bluenvironment. *Report on behalf of North Lanarkshire Council on the Landscape and Visual Impacts of the Proposed Black Law Wind Farm Extension Phase 2*. Newark. 2013.

Paper in journal:

Aylward, Graeme and Turnbull, Mark. 'Visual Descriptors'; *Design Methods and Theories Journal*, vol 12 No 2; 1978.

Oppressed Bodies and Embodied Repressions – Mandatory *Hijab* and Facades in Contemporary Iran

Abstract

Ideological struggles and relations of domination emerge on surfaces “as so many attempts to obfuscate/reconcile/master [these] antagonism[s].”¹The resulted forms, nonetheless, are not necessarily distorted or unpleasant; instead, they bear aesthetic values which demand interpretation. Makeup and decorated facades alike might be visually appealing, yet they can be symptomatic of social struggles. Not only the excess of cosmetics or decoration, but their absence can also be symptomatic. This paper interrogates the homologous surface phenomena apropos of bodies and architecture. If lipstick is a symptom of compulsory Hijab, decorative surfaces on facades are externalization of problems of privacy and interiority, characteristics of living in a disciplinary society. I will articulate the relationship between decorative screens on architectural facades and symptomatic representations on the surface of bodies in the context of women’s oppression in the present-day Iran.

Introduction

Can oppressed bodies form embodied repressions? How to analyze the shared symptoms evident at the surface of bodies—skins and clothes alike—and surface of buildings? The distinction here does not only pertain to the dyadic relationship between inside and outside, the “expressive correspondence”² between the interior and exterior, or their manifest incommensurability. Rather, the question regards the degrees of interiority and layers of exteriority, that is, the problematics of surface condition. Indeed, psychoanalysis concerns surface effects first and depth second: “Even when we penetrate the subject’s innermost sanctum, the very core of its Unconscious, what we find there is the pure surface of a fantasmatic screen.”³ What appears at the formal level is not simply a representation of the content, but this appearance can “[articulate]

¹ Žižek, Slavoj. 2013. *Less than nothing: Hegel and the shadow of dialectical materialism*. London [u.a.]: Verso. P. 782

² Jameson, Fredric. 1994. *The seeds of time*. New York: Columbia University Press. P. 135

³ Žižek, Slavoj. 2015. *Organs without bodies: on Deleuze and consequences : with a new introduction by the author*. London: Routledge. P. 93

what is repressed in the content.”⁴

There are moments when architectural projects seem to be explicitly refined on both formal and functional levels. On practical level, they serve their intended use, fulfilling the functional vocations; on aesthetic level, their appealing form offer harmonious, rather exciting, spatial and compositional dispositions. The interior, the disposition of spaces and their relations, is functional and at the same time aesthetically pleasing. The exterior, too, entertains both qualities. Yet, the design principle governing the one is in radical contrast to the logic shaping the other. In other words, while different moments in the project are autonomously harmonious, the scheme as a whole reflects on inherent contradictions of these individual instances. If each space tells a story of its own, the tapestry of mutually exclusive narratives brings forth the contradictions of the message embedded in the language of such projects. The inconsistencies, nevertheless, should not be construed as stylistic discrepancies, but as symptoms rooted in social deadlocks. Similarly, images of ordinary Iranian females walking on streets of Tehran, in many cases, rival the images presented in the latest European fashion magazines. In the background, nonetheless, one can find giant billboards promoting a strict form of Hijab. Such inconsistencies demand interpretations beyond aesthetics.

Iran’s theocratic state denounces the dissolute way of life and moral disintegration of society, blaming it on women’s appearance. Although the problematic relationship of Iranian women and compulsory Hijab has been brought into sharp focus through several critical points in history,⁵ the recent gesture, enacted circa April 2016, is dramatic in its scope and intensity. In Tehran alone, 7000 undercover morality agents have been deployed to crackdown any form of transgression to the new dress code. These extreme measures aim at—as the government postulates—reviving lost moral values, returning the deflated dignity of women, etc. all of which sounds innocuous, if not quite positive. Supposed to simply change the surface, their effects are much more virulent.

Oppression and Surface

In encountering an image of an Iranian female student—photographed in public—a crucial aspect immediately follows: the hair is covered. More than the presence of such a covering, its functional absence is striking. Instead of covering—protecting the hair, neck, and ears from an assumed gaze—the scarf reveals certain areas in a way which undermines its intended purpose. Rather than inspiring the notion of modesty, demanded by Islamic law, the “polymorphous perversity” of such covering sexualizes the body.

What is covered, nonetheless, is not the hair *per se*. Incidentally, the predominant style, where a light scarf or shawl is loosely wrapped around the head, does not serve the expected task. What is hidden, or to be more precise, what is forced to be concealed, is all that which the authoritarian state and its disciplinary institutions

⁴ Ibid, P. 77

⁵ Mahdi, Ali Akbar. 2004. „The Iranian Women’s Movement: A Century Long Struggle”. *The Muslim World*. 94 (4): 427-448.

construe as a threat to its stability, that is, to its totalitarian, yet precarious sovereignty. Discontent with the patriarchal social order and the ensuing subordination of women, from one side, and transgressive identities and gender deviations, from the other, are all suppressed beneath the scarf. Compulsory Hijab becomes an apparatus by which control is administered and around which social hierarchies and inequalities are structured. A disciplinary apparatus which secures the stability of the dominant class against the emancipatory capacities of women's liberation. Wearing a scarf might appear trivial in the face of larger social and economic predicaments, it, nonetheless, is constitutive of many of these predicaments. Subjugation of women is not merely producing docile subjects interpolated by repressive or ideological state apparatuses, but this subjectivity contributes to a social order troubled on multiple levels. Under the perpetuated domination, subjects not only experience, but develop "mental inferiority and habits of subservience and obedience."⁶

The counter-hegemonic strategies of Iranian women are embodied in corporeal techniques. As Georg Simmel puts it: "Clothing is one of the battlefields, and fashion is one of its strategies."⁷ The corporeal expressions bear spatial implications. The public domain once attributed to men and could only afford a tenuous presence of women, is now decolonized by progressive women who assert autonomy and claiming equal participation. Despite the visual appeal of the emerging forms of resistance, as women use makeup (sometimes excessively) to contest the state's dictate for modest expressions, such phenomena should not be dismissed as aesthetic solutions to the socio-political deadlock. The remainder of social struggles returns with vengeance.

The incommensurability of women's public appearance and her private fantasies are structurally similar to the inconsistencies between architecture's inside and outside. The psychoanalytic method which articulates subjectivities and their unconscious processes can interpret spatial symptoms. Parallel to the Lacanian formula where—beyond a linguistic signifier—a symptom is "a symbol written in the sand of the flesh"⁸ therefore being present in both speech and body, architectural symptoms too are fully manifest at the surface level.

Surface as Symptom

Symptoms are surface phenomena, instigating the complex interplay of inside and outside. Freud articulates the relationship between the body as a surface phenomenon and psyche as the domain of desires. He situates the surface of the body as the locus of "both external and internal perceptions."⁹ For him the ego is not "merely a surface entity," but what Freud calls a bodily ego is "the projection of a surface." Based on the imaginary and sensual perception of this surface, one constructs a mental image

⁶ Jameson, Fredric. 2015. „Third-World Literature in the Era of Multinational Capitalism”. P. 76

⁷ Colomina, Beatriz, and Jennifer Bloomer. 2007. *Sexuality & [and] space: [symposium held at Princeton University School of Architecture, March 10-11, 1990]*. New York: Princeton Architectural Press P. 94

⁸ Lacan, Jacques. 1996. *Ecrits*. Paris: Éd. du Seuil. "Discourse of Rome," P. 69

⁹ Freud, Sigmund, and James Strachey. 1989. *The ego and the id*. New York: Norton. P. 7

and this “mental projection of the surface of the body”¹⁰ is precisely the ego itself. This projection, nevertheless, exceeds its corporeal base, its “physical reality.” In other words, there is always a gap between this reality of body and the conceptual projection—a constitutive gap which can only be filled by fantasy.

Subject’s desire fills the gap between the imaginary presence of the body and what it constructs as its own reality. The subject therefore, is not only a product of linguistic structures, disciplinary discourse, or social order. It is rather the very void constituted between images and words. Images, or the imaginary projections, are based on the body, yet reaffirmed by social discourses. Why is the “mental projection of the surface of the body” not the same as reality? Because the subject sees that surface only through the Symbolic—seeing through an ideological lens shaped by subject’s inevitable inscription into the social order. “Seeing” is conditioned by the Symbolic—that is, the unconscious realm of the language, law, order, and structure.

What is at stake here is the inevitable inconsistency between the epidermal schema, falling back onto the subject by an external gaze, and the corporeal schema as an “internal” construction. Fanon regards this inconsistency as the effect of race: “normal black child, having grown up with a normal family, will become abnormal at the slightest contact with the white world.”¹¹ The collapse of the body schema under oppressive forces gives way “to an epidermal racial schema.” What draws a definitive line between Fanon and Lacan is the assumption that “a normal child brought up in a normal family will become a normal adult,” although Fanon cast a self-criticism in the footnote.¹² For Lacan, on the other hand, this incommensurability is not idiosyncratic to a particular race or gender, but constitutive of human existence.¹³ The principal contradiction for Lacan is not between a subject’s internal schema and what s/he perceives through an external gaze—the two are the same at this level as the subjective image of the self is always “colored” by an imagined external gaze. The crucial difference emerges when the subject is caught between appropriating multiple, yet contradictory schemas.

The problem associated with the compulsory Hijab is that even if the subject stays relatively consistent in her choice of an appearance, she still confronts multiple symbolic gazes which are themselves contradictory. Since the symbolic order and its social constructs, even the smallest social unit, that is, a family, might bear contradictory rules, the subject is constantly trying to accommodate herself to any number of those ideological constructions. Let us imagine this scenario: A liberal and permissive father which regards his daughter’s rejection of Hijab as a progressive response; a conservative mother which is intolerant toward her dissident daughter; a fanatic brother who debases females like his sister to prostitutes, all are returning contradictory gazes.

¹⁰ Ibid.

¹¹ Fanon, Frantz. 2008 from the original 1952 [Peau noire, masques blancs]. *Black Skin, White Masks*. New York: Grove Press. P. 122

¹² Ibid, P. 121

¹³ Žižek, Slavoj. 2015. *Organs without bodies: on Deleuze and consequences : with a new introduction by the author*. London: Routledge. P. 96

Body constitutes the locus and “the material ground of subject formation.”¹⁴ The split between the two schemas results in a split body-ego, causing it to be “continually fractured, time and again denied and re-asserted;” a process which is ultimately traumatic. If through the contrast between the epidermic and corporeal schema, the black skin functions as the domain of pathologies, here, the scarf, and the fantasies embedded in its presence, resurface the same predicament. Architectural facades, veiling a functional building, are spatial equivalent of this epidermal schema.

There is a parallel relationship between facades and Hijab as two modes of representation, two mediatory devices which mask their content. Beyond their immediate functions in sheltering and protecting the body, architecture and clothing operate on a symbolic level. Integral to both, embodiment is a material representation of a concept. It is loaded with a symbolic implication: that is, giving tangible forms to the totality of bodily presences and the “necessary precondition for subjectivity, emotion, language, thought and social interaction.”¹⁵ This representational function turns both into a medium, the message of which reflects on much deeper social phenomena.

There is a parallel relationship between facades and Hijab as two modes of representation, two mediatory devices which mask what they possess inside. Beyond their immediate functions in sheltering and protecting the body, architecture and clothing operate on symbolic level. Giving tangible forms to the totality of bodily presences, embodiment, as a concept, also lays the foundation for the “necessary precondition for subjectivity, emotion, language, thought and social interaction.”¹⁶ This representational function turns bodies made of flesh and bodies made of brick into a medium the message of which reflects on much deeper social phenomena.

Here, the two forms of subjectivities (that of the woman and architecture) are products of the same symbolic order, while simultaneously contribute to the consolidation (or attenuation) of this very order. What strikes the eye on the image on the left is the pattern. Why does one attach a piece of history on her body? Similarly, why the otherwise fully functional building should attach a screen on its body? Effectively the screen is hindering the interior’s direct access to the light and views alike. The neighborhood has called the building “prison.” Interestingly enough, the interior is stylistically pro-Western; it does not represent any feature that witness a relationship to its immediate (cultural) context. This desperate urge for identifying oneself with an imagined historical identity is contradicted by a desire for modernity. Historical elements on the facade mask a pro-Western interior. Despite the size of the apartments, independent of the dominant style of the neighbourhood, and regardless of the religious beliefs, the kitchen is always open. As if a more conventional kitchen with certain degree of closure stands for dogma and retrogression. The symbolic openness is the ideological surrogate for all the boundaries and predicaments. “[w]

¹⁴ de Lauretis, Teresa. 2010. *Freud's drive: psychoanalysis, literature and film*. Basingstoke: Palgrave Macmillan. P. 52

¹⁵ Sander, David, and Klaus R. Scherer. 2009. *The Oxford companion to emotion and the affective sciences*. Oxford: Oxford University Press.

¹⁶ Sander, David, and Klaus R. Scherer. 2009. *The Oxford companion to emotion and the affective sciences*. Oxford: Oxford University Press.

hen a building embodies democratic openness,” Žižek reminds us, “this appearance is never a mere appearance—it has a reality of its own, it structures the way individuals interact in their real lives.”¹⁷



Fig. 01. Contradiction between exterior and interior (Collage by the author)

Source: Courtesy to Habibeh Madjdabadi

Here, taming women to the desire of the state and its conjoint patriarchal social order is not merely aimed at further domesticating progressive females. With instilling a universal terror, an omnipresent panopticon, and its uncontested triumph in subjugating women, men too, that is the entire social sphere, are interpellated as docile subjects. Žižek echoes Butler as he argues “since power generates the very resistance to itself, the subject that strives to liberate itself from the clutches of power is already a product of power, of its disciplinary and controlling mechanisms.”¹⁸ This regulatory power extends itself to the most internal layer of subjectivity: “the very ‘repressive’ mechanism that regulates our sexual lives generates Sex as the excess, the ‘dark continent,’ that needs to be regulated.”¹⁹

Epilogue (Summary)

The recent exaggeration of an already restrictive female dress code in Iran have not only been conducive to the rise of new forms of civil resistance, but also to the consolidation of problematic socio-cultural formations. Out of the intricate relationship between oppressions and resistance against them, a new human subjectivity and thereupon new forms of cultural representation are emerging. While the emergence of new modes of resistance is immediate—as evident in the outburst of creativity in Iran’s fashion industry—reflection on psychic transformations is inherently slow. Architecture, as the domain of cultural representations, reflects more on the collective unconscious of a culture than immediate surface phenomena.

When the external layer of the public domain, as the symbolic representation of

¹⁷ Žižek, Slavoj. 2010. *Living in the end times*. London: Verso. pp. 244-274

¹⁸ Žižek, Slavoj. 2004. *Organs without bodies: Deleuze and consequences*. New York: Routledge. P. 71

¹⁹ Ibid.

social relations, is turned into a site for antagonistic encounters, the internal domain of mental states, is the site of conflictual desires. The paradoxical relationship between the inside and outside, contradictory expressions of privacy, hierarchy, and order, a compulsive search for an authentic identity, an obsession with history, all in one way or another are symptomatic of social pathologies which although are not exclusive to architecture appear again and again in uncanny forms in spatial terms.

The master signifier of Iran's domestic architecture, the brick screens attached on the façade, veils something curious. The parallel operation of veiling a body and covering a building reflects on a culture's repressed desires. The utter discordance between women's appearance (fully covered and cocooned in scarf) and her inner fantasies (social freedom and equality) is deeply problematic. Bodies but also the entire public sphere have turned into a site of antagonism where ironically but sadly "lipsticks are weapons." This is not the real predicament. When the oppressive forces exceed the tolerable limits, the external suppressions turn inward.

A pro-Western interior with open-kitchens and satellite TVs to receive CNN, against an exterior which provides explicit references to historical motifs should not be dismissed as a stylistic discrepancy. This is not to say these symptoms should be eliminated or the sign of failure of the resistance. As Silverman points out, these deviated forms of subjectivities, the margins, are those who can revolt against the dominant fiction.

Mutually exclusive expressions (open-closed, private-public, masculine-feminine, garish-modest, etc.) are functioning as the return of the repressed of social freedoms. The very attempt in covering up the contradictions is precisely that which renders ideological antagonisms visible. Although the booming real estate market and its alignment with liberal global capitalism might appear as an emblem of prosperity and a facet of modernity, the story of Iran's architecture is a poignant drama.

Bibliography

- Colomina, Beatriz, and Jennifer Bloomer. 1999. *Sexuality & space*. New York, NY: Princeton Architectural Press.
- De Lauretis, Teresa, 2010. *Freud's Drive: Psychoanalysis, Literature and Film*. Basingstoke: Palgrave Macmillan.
- FANON, FRANTZ, 2017. *Black Skin, White Masks*. [Place of publication not identified]: PLUTO Press.
- Foucault, Michel, 2009. *Discipline and Punish: The Birth of the Prison*. [S.n.]: Vintage.
- Foucault, Michel, Hurley, Robert., 2008. *The History of Sexuality. Volume 1, Volume 1*. Camberwell, Vic.: Penguin.
- Freud, Sigmund., 2013. *The Ego and the Id*.
- Jameson, Fredric., 2015. "Third-World Literature in the Era of Multinational Capitalism." : 71-90.
- Jameson, Fredric., 1994. *The Seeds of Time*. New York: Columbia University Press.
- Lacan, Jacques., 1996. *Ecrits*. Paris: Éd. du Seuil.

- Mahdi, Ali Akbar,. 2004. "The Iranian Women's Movement: A Century Long Struggle." *The Muslim World the Muslim World* 94 (4): 427-448.
- Silverman, Kaja. 2016. Male subjectivity at the margins. [Place of publication not identified]: Routledge.
- Sander, David., Scherer, Klaus R.,. 2014. *The Oxford Companion to Emotion and the Affective Sciences*. Oxford: Oxford University Press.
- Žižek, Slavoj,., 2013. *Less than Nothing : Hegel and the Shadow of Dialectical Materialism*. London [u.a.]: Verso.
- Zizek, Slavoj,., 2004. *Organs without Bodies : Deleuze and Consequences*. London: Routledge.
- Žižek, Slavoj,., 2011. *Living in the End Times*. London; New York: Verso.

Toward Time-Like Oriented Approaches in Architectural Education

Abstract

Architecture, as a space-based profession, has traditionally pledged allegiance to the notion of timelessness. Likewise, in architectural education, the fundamental core of knowledge is still wedded to the notion of a space-like strategy that is linear and sequential. To respond to the dynamic real world, this paper suggests that schools of architecture should shift from space-like to more time-like design education. In a time-like design strategy that is nonlinear and complex, architectural education is not only concerned with space and spatial configurations, but also with time. Here, time is not treated as a constant parameter. When tied to a particular time, architectural education is no longer timeless.

Keywords: time-like Architecture, Meaningful place, Transformable architecture, architectural education.

“As there is a geometry in space, so there is a psychology in time”.
– Marcel Proust (Proust, 1996)

Introduction

For far too long, the education of future architects has – with rare exceptions – been conceived of as the creative effort behind static buildings frozen in time; this notion has isolated students from their world. Future architects are still predominantly educated to build outside of the continuum of time (Juhani, 2007) and withstand its forces.

Intended to remain static, students’ building proposals are expected to dispel the workings of time. In other words, architecture students, as designers of future buildings, are trained to be less intolerant of the future and changes to their designs.

Although the emergence of time and movement in architecture stretches back to the beginning of the twentieth century, it has not fully permeated into the design projects of student architects. Despite the idea of “space-time” seen during the last century most architecture programs have an ambiguous relationship with movement.

Although motion has long been part of the architectural repertoire of 20th and 21st century, but contemporary activities in architecture education are evidence of a lack of a holistic approach to the study of motion in architecture, and the design of motion as an alternative mode of design thinking is still in its infancy. Most conventional schools of architecture distance themselves from a time-like approach. In these schools, the inherent differences between space and time are not reconciled and, in majority of cases, students' perceptions of space and time are treated as separate entities. While learning to "domesticate space", most of students struggle with the "the terror of time" to deal with beauty as a timeless reality (Harries, 1982).

Toward a time-like approach

In a time-like approach, by denoting a time-dependent set of architectural elements, schools of architecture have the opportunity to educate architects beyond the boundaries of the static spatial conditions that tend to neglect or ignore temporality.

Since transformation is bound to time, the goal is to put transformable architecture into perspective with respect to time-like architecture. Transformable architecture can chart a territory where motion can bring time into the architecture of space.

As a kinesthetic object goes from one movement to the next, motion and time are confluent and belong to one another. By establishing dynamic spatial relations, the fundamental premise upon which transformable architecture rests is the binding together of the concepts of time, motion, space, and meaning.

Once architecture is set in motion, it is constantly trapped in the tension between change and stability. Orchestrating the cycles and flows of movement in architecture necessitates an exploration of the conflict between the stasis and dynamism of different phases of generations and the decay of movement. If we accept that movement occupies both space and time and describes the position and trajectory of an artifact, stasis becomes a form of movement in space-time. Thus, the desire for stasis lies in a lack of physical motion between artifacts in space.

Temporal and spatial contradictions between movement and stasis come together through transformable architecture. By mapping invisible transitory forces that grow, dissipate, and dissolve, this type of architecture questions the very notion of the dialectical tension between stasis and movement, revealing and tracing their structures and patterns. Concentrating on the spatio-temporal aspects, the function of transformable architecture is considered by the process with which it keeps alive the dynamic interplay between stasis and movement. Negotiating between stasis and movement, transformable architecture can be described not purely as a dynamic system, but also as a static one; it is a combination of the two.

At its foundation, transformable architecture is concerned with two domains associated with transformable boundaries, one physical and the other meta-physical. Both domains merge in the experience of the observer as the system transforms its appearance in response to changes in the ambient environment. The physical transformation relates to the movement of the system from open to closed in response to stimulation from the external environment. The second domain of inquiry for transformable architecture is the meta-physical that can evoke a perceptual response

of the viewer. This perceptual response occupies the meta-physical space between the objects that moves and the cognitive processing of mental stimulation. The mental stimulation is the result of experiencing the interaction of the architecture with environmental variables including light level, solar intensity, sun position and outdoor air temperature. The understanding of this transformative boundary between the object and perception is key to the design and implementation of transformable architecture. By understanding this meta-physical boundary through its design, transformable architecture has the potential to change our view of the environment and its meaning. From a phenomenological theoretical position that recognizes that meaning given to architectural spaces and building systems is the result of sensory stimulation and the mental processing of that stimuli, transformable architecture becomes a transformative boundary that provokes one's perceptual response toward either self-awareness or an understanding of one's place within a larger external world.

Motion and Architectural Education

Motion, as the essence of all being, should be more prominent in architectural education. Exploring the nature of time and sensing the environment created by time are practices that should be integrated early on in the design process. As mentioned above, architectural education's relationship to motion is typically posed as a battle against the paradigms of stasis. It seems that a student's ability to harness valid design modalities and ascertain their relative values can be directly tied to their breadth of experience and knowledge about both static and dynamic forms to create a meaningful space. As a pedagogical strategy, the introduction of transformable architecture can be critical to students' ability to develop a greater level of conceptual rigor about space and expand their ways of seeing and practicing architecture (figure1).

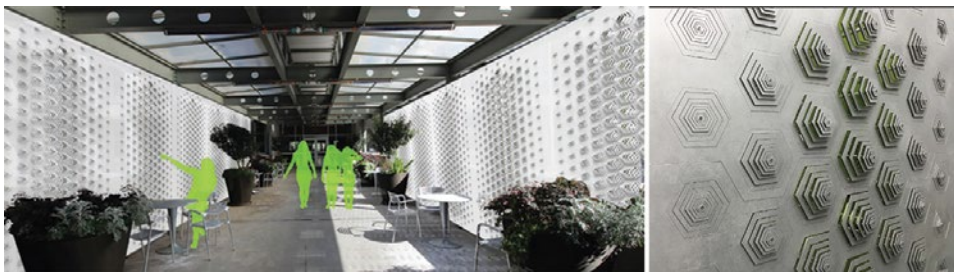

Fig. 01. tranSTUDIO (thought by author) is a design studio at Texas A&M University focusing on transformable façade design. Project by Sydney Ritter & kristin higgins

By acknowledging the presence of motion from a small scale to full scale, the main objective is to cast light on how a concept of motion can be oriented toward shaping a better environment and understand its quality. Acknowledging the positive aspects of change-oriented approaches in architectural education can help students to design buildings that are connected to space, and time, to create a meaningful place; embracing the inseparable link between these concepts will lead the field to the much broader notion of building-in-time. The author believes, to some extent, that transformability in architecture has given rise to a new debate about the education

of architects and the relation of space and time, but the discussion has yet to offer a common framework for the future of architectural education. The main question is if education can offer a core of transformable knowledge to aspiring architects and if so, how this knowledge should be introduced such that it initiates a new kind of awareness about meaning in architecture to the extent that a new pedagogical circle and design practice is born.

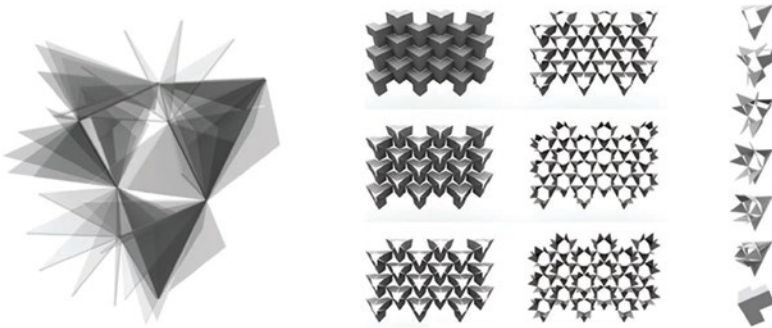

Fig. 02. From static to dynamic. Project by Tyler Boyett and Ashley Feyes

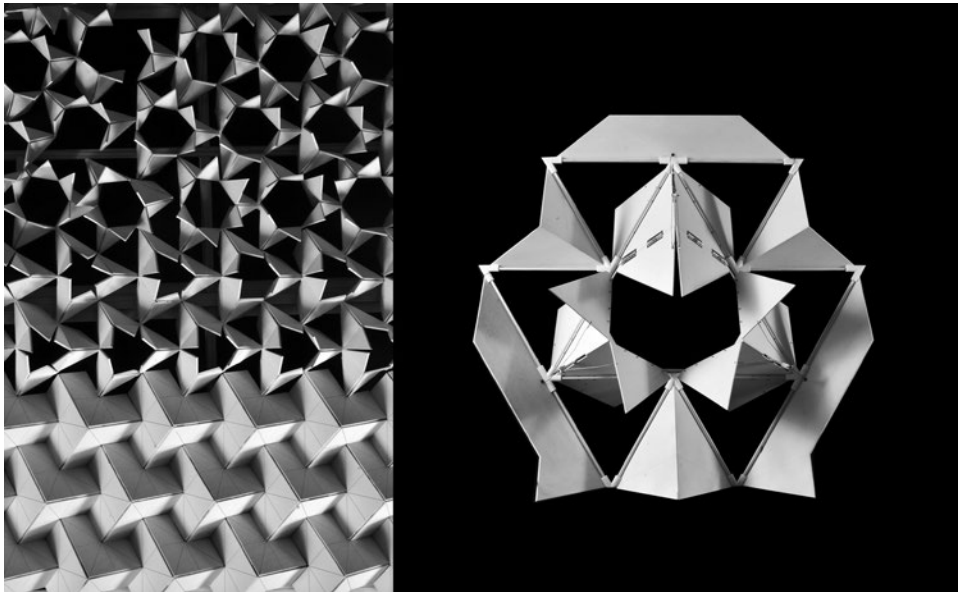

Fig. 03. From static to dynamic. Project by Tyler Boyett and Ashley Feyes

Conclusion

To talk about transformable architecture means to minimize the conflict between the static and the dynamic by enhancing experiences of time passing (figure 2&3). Moving away from the monumental and long lasting qualities of classic architecture towards improving the qualities of and relationship between space and time, transformable architecture propounds time as a mental dimension to affect positively

the occupant's life. Being no longer inferior to space, the presence of time is celebrated in transformable architecture to allow the occupants to physically experience and psychologically interact with the environment. In this case, actuality and memory can come alive to facilitate peoples' memories and perceptions to mingle.

By introducing the factor of time as one way to adapt or respond to possible changes, transformation in architecture aims to improve sustainability in relation to the endless temporal flux that underlies it. In transformable architecture, through the implicit presence of light or wind, the sense of passing of time is made explicit. Therefore, it is less possible to demarcate the space from the time.

Bibliography

- Proust, Marcel. *In Search of Lost Time, Volume 5: The Captive, The Fugitive*, London: Random House, 1996
- Pallasmaa, Juhani. "The Space of Time – Mental Time in Architecture", in *The Antwerp Design Sciences Cahiers*, Nr. 17, Henry Van De Velde College of Design Sciences, Antwerp, 2007
- Harries, Karsten. "Building and the Terror of Time", *Perspecta*, Yale Architectural Journal, issue 19, Cambridge: The MIT Press, 1982.

Persuasive Sway of Rendering Media

Introduction

At times, the fate of a building project rests on a client's interpretation of design illustrations. Their response to that imagery can determine whether or not a project is approved, altered, or even terminated. While designers and architects have a myriad of communication tools, e.g., computer-generated, hand-drawn sketch, etc., available to produce project depictions, decisions about media choice and rendering style are frequently subject to constraints of skill and schedule. But, surprisingly, given that these representations are a vital tool with which to communicate design intent, the subject of media choice has received relatively little scholarly consideration. While some scholars have sought to explore facets of this topic, these inquiries have focused largely on representational validity,¹ or on credibility comparisons between traditional and computer generated renderings.² Consequently, studies focused on viewer response to various representation techniques of the same interior environment remain lacking in the literature, even as the style in which a designer might express their ideas may influence perceptions of the design itself.

Background

Industrial design scholars Monö³ and, later, Crilley, Moultrie, and Clarkson,⁴ drew parallels between industrial design communication and the Shannon-Weaver model of communication.⁵ Following their characterization, the design team acts as the message source, the project outcome as the transmitter, the environment as the channel, and the client, the receiver. It seems logical to extend this premise to architectural and design communication by characterizing the architectural rendering

¹ Daniel, T.C., Meitner, M.M. „Representational validity of landscape visualizations: The effects of graphical realism on perceived scenic beauty of forest vistas”. *Journal of Environmental Design*. vol. 2. no. 1. 2001. p. 61-72.

² Bates-Brkljac, N. „Assessing the perceived credibility of traditional and computer generated architectural representations.” *Design Studies*. vol. 30. no. 4. 2009. p. 415-437.

³ Monö, R. *Design for Product Understanding*. Stockholm: Liber. 1997.

⁴ Crilley, N., Moultrie, J., & Clarkson, P.J. „Seeing Things: consumer response to the visual domain in product design”. *Design Studies*. vol. 25. 2004. p. 547-577.

⁵ Shannon, C.E. “A mathematical theory of communication”. *Bell Systems Technical Journal*. vol. 27. 1948. p. 379-423.

as the transmitter.

Given that the goal of many design communications is to garner a positive viewer response, it becomes important to understand any potential transmitter factors that may influence these evaluations. Crilly et al. categorized such responses according to consumer behaviour paradigms of cognition, affect, and behaviour. ⁶

Cognition

Crilly's team surmised cognitive responses to be sensory judgements as:

1. Aesthetic impressions of a design's attractiveness
2. Semantic or functional interpretations of how the design could be used, and
3. Symbolic associations, or the personal and social significance of the design (i.e., the message conveyed by the design about its owner). ⁷

Affect

Affective or emotional responses to a product were classified by Demet according to a design's:

1. Novelness (surprise emotions),
2. Function (instrumental emotions),
3. Appealingness (aesthetics emotions),
4. Compliance with social norms (social emotions), and
5. Stimulative value (interest emotions). ⁸

Behavior

Together, these cognitive and affective responses influence a viewer's behaviors, causing them to either accept or reject a design.⁹ In the case of the built environment, the stakes of these behaviors can be high. Design teams can be hired or fired, projects approved or halted, and costly decisions made.

Purpose

As architects and designers have many communication tools at their disposal, the question becomes how media type influences viewer response. However, the literature is lacking a direct comparison of media types communicating the same design.

The premise of this study was to ascertain viewers' cognitive and emotional responses to a single design by focusing on their aesthetic impressions of renderings, with each rendering varying only in media type. To do so, study participants were prompted to evaluate renderings and their feelings about the renderings. Data were collected from two groups, experts (i.e., design practitioners who select media), and a general population sample (representing proxy clients). The goal was to gain

⁶ Crilly, N., Moultrie, J., & Clarkson, P.J. "Seeing things: Consumer response to the visual domain in product design." *Design Studies*. vol. 25. 2004. p. 547-577.

⁷ Ibid.

⁸ Demet, P. "A multi-layered model of product emotions". *The Design Journal*. vol. 6. no. 2. 2003. p. 4-13.

⁹ Crilly, N., Moultrie, J., & Clarkson, P.J. "Seeing things.." 2004. p. 547-577.

information from those who produce renderings, and those who evaluate them.

Methods

Rendering Development

Four renderings of the same design were developed using different techniques (See Fig. 01):

1. Hand-drawn sketch with colour pencil rendering (Image A)
2. Hybrid rendering using colour pencil and computer-generated graphic filters (Image B)
3. Computer-generated, semi-photorealistic rendering (Image C)
4. Computer-generated, shaded representation (Image D)

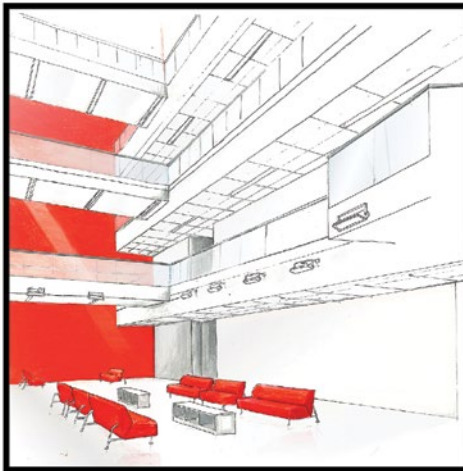

Image A



Image B



Image C

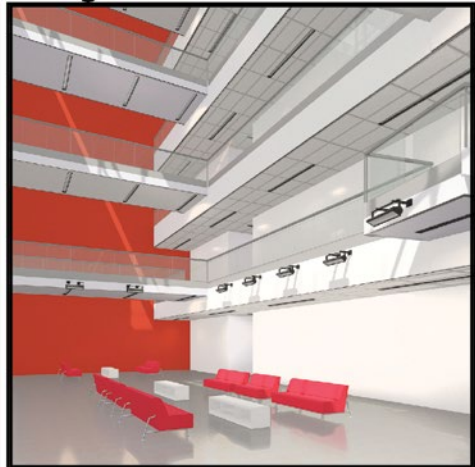

Image D

Fig. 01. Renderings generated for the intervention.

Source: author

To increase the study's validity, the renderings were conceptualized to be as similar as possible. Each focused on the design from the same viewing angle, included the same design features, and used similar colours. Additionally, the survey was pilot tested by two groups, one of which was shown the renderings while the other group viewed a different set of four renderings). To reduce measurement bias, participants were shown the renderings in a randomized order, thus reducing the chances that aggregate respondent scores would be prejudiced by the respondents' order of exposure to the renderings.

Instrument Development

The goal was to have viewers evaluate each rendering's aesthetics (cognitive response), and their reactions to them (affective response). Several tools have been developed to measure such responses. Osgood, Suci, and Tannebaum offered 50 bi-polar scales, wherein 50% of variance was accounted for in three measures: good-bad evaluations, strong-weak measures of potency, and calm or chaotic activity.¹⁰ Later, Mehrabian and Russel's Semantic Differential Scale offered 18 bipolar adjectives pairs, grouped according to factors of: pleasure, arousal, and dominance.¹¹ Finally, Bates-Brkljac offered scales according to accuracy, realism, and abstraction.¹²

Using these studies as a framework for comparison, this research measured cognitive responses as to the renderings' accuracy and potency, while affective responses were ascertained through the respondents' self-reports of arousal and pleasure. Bio-polar pairings from the aforementioned studies were included in this study's instrument if:

1. they had been previously used to measure one of the four relevant areas (i.e., accuracy, arousal, pleasure or potency), and
2. they were deemed to be valid measurements, evidenced by either having been used in multiple studies or having received high factor loadings in subsequent testing.¹³

Each scale was seven points (1 low and 7 high). To triangulate data, respondents also shared their perceptions of strengths and weaknesses of each rendering via heat maps, and provided a rank ordering of the renderings.

Data collection

Study participants from various demographic groups responded to an online survey. Table 1 describes participant characteristics.

¹⁰ Osgood, C., Suci, G., Tannedbaum, P. *The measurement of meaning*. Urbana, IL: University of IL. 1957.

¹¹ Mehrabian, A., & Russel, J.A. *An approach to environmental psychology*. Cambridge, MA: MIT. 1974.

¹² Bates-Brkljac, N. "Assessing perceived credibility of traditional and computer generated architectural representations". *Design Studies*. vol. 30. no. 4. 2009. p. 415-437.

¹³ Bradley, M.M. & Lang, P.J. "Measuring Emotion: The self-assessment manikin and the semantic differential. *Journal of Behaviour Therapy and Experimental Psychiatry*. vol. 25. No. 1. 1994. p. 49-59.

Table 01. Participant characteristics.

	General Population (n=60)	Experts (n=20)
Education		
Some college	54.8%	10%
Bachelor's degree	31.7%	55%
Master's degree	6.3%	35%
Ph.D.	3.3%	0%
Age		
18-34	16.7%	57.1%
35-54	33.3%	33.3%
55-64	28.3%	4.8%
>65	21.7%	0%
Profession	14.8% Science & Technology 11.2% Business/Legal 8.5 % Arts 7.4% Construction/Manuf. 3.7 % Education 54.4% Other	100% Design (Architecture or Interiors)

Findings

Semantic variable scores

As indicated in Table 2, the general population (GP) scored Image C relatively higher in all but one measure (excitement). Their highest scores for each image were generally in affective measures with Friedman tests revealing statistically significantly higher scores for Image C in the areas of naturalness ($\chi^2(2) = 9.406, p = 0.009$), strength ($\chi^2(2) = 10.308, p = 0.006$), and pleasure ($\chi^2(2) = 6.186, p = 0.045$). Image A highest scores were in pleasure and happiness; Image B, happiness and relaxation; Image C, honesty and pleasure, and for Image D, honesty and relaxation. The expert population (EP) scored Image C relatively higher in 60% of the categories, but high scores were more equally distributed amongst the four renderings. While the expert sample was too small for meaningful statistical significance testing, the highest scores for each image suggest higher evaluations in measures of potency and pleasure. Highest scores for Image A were in happiness and honesty; Image B, pleasure and strength; Image C, happiness and vividness; and for Image D, pleasure and vividness.

Table 02. Semantic Variable Scores.

		General Population (GP)				Expert Population (EP)			
		A	B	C	D	A	B	C	D
Accuracy	Vague/Precise	4.22	4.56	5.04	4.77	3.60	4.35	4.65	3.45
	Dishonest/Honest	4.87	4.95	5.21	5.02	4.47	3.94	4.00	3.73
	*Artificial/Natural	3.54	4.33	4.56	4.11	4.07	3.53	3.24	3.09
Potency	*Weak/Strong	4.35	4.37	5.27	4.77	4.40	4.59	4.71	4.18
	Dull/Vivid	3.91	4.41	4.83	4.15	4.13	4.12	4.76	4.36
Arousal	Tense/Relaxed	4.54	4.67	4.79	4.78	4.13	3.94	3.94	4.36
	Calm/Excited	4.17	4.41	4.31	4.15	4.00	4.00	4.29	4.09
	Bored/Interested	3.85	4.59	4.88	4.34	3.67	3.53	3.94	4.00
Pleasure	Ugly/Beautiful	4.26	4.36	4.79	4.38	4.20	4.35	4.35	4.00
	Displeasing/Pleasing	4.28	4.62	4.98	4.64	4.60	4.65	4.24	4.09
	Unhappy/Happy	4.50	4.87	5.00	4.62	4.60	4.35	4.76	4.18
	*Annoyed/Pleased	4.52	4.64	5.19	4.72	4.40	4.41	4.59	4.55
	Satisfied/Unsatisfied	4.16	4.46	4.92	4.55	4.13	4.29	4.35	4.09

highest scores are indicated in **bold** , *Stastically signficant at $p < .05$, expert sample too small for testing

Figure 2 illustrates mean(μ) scores for each image in the accuracy, arousal, potency, and pleasure categories, with Cronbach’s Alpha suggesting a high level of internal consistency for those categories with $\alpha > .7$.

Amongst the GP cohort, mean scores for categories of potency and pleasure were highest for Image C ($\mu = 5.05$ and $\mu = 4.98$, respectively). While the EP sample was less likely to score Image C higher, and consistently scored all of the images lower than their GP counterparts.

Rank Order

When asked to rank order the images, 58% of the GP cohort rated Image C the highest, followed by Images B, D, with 38% rating image A last. The EP cohort evaluated Images B & C number one in equal numbers, followed by Image A, with 60% scoring Image D least favourably.

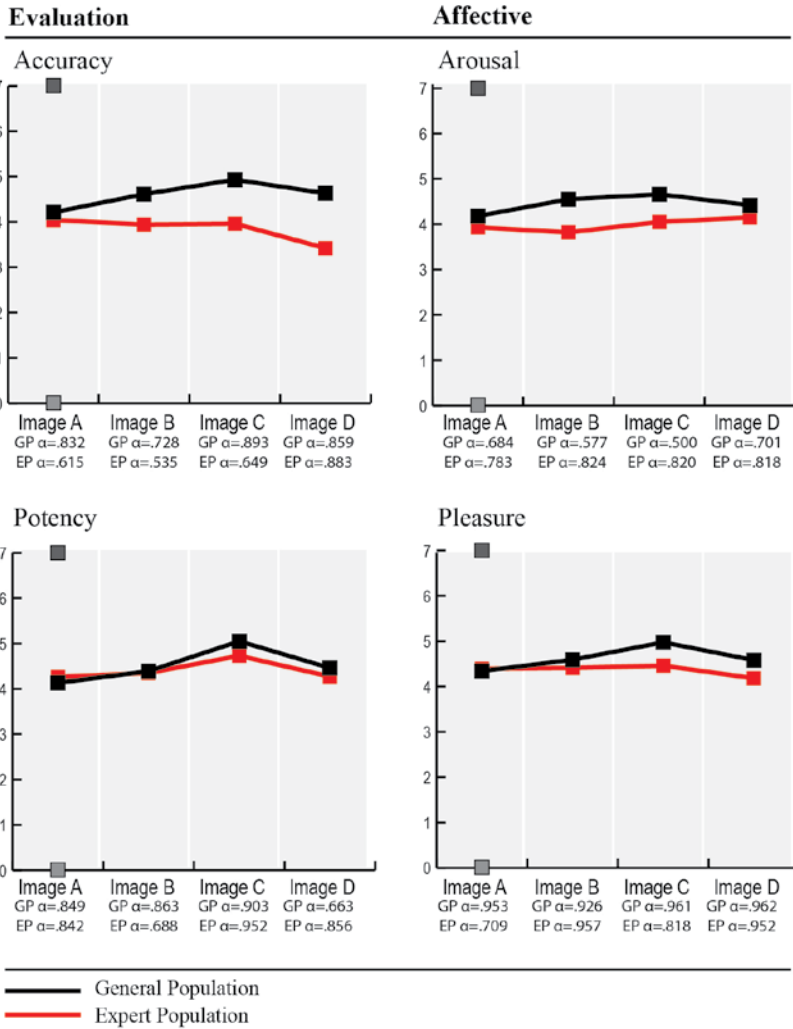

Fig. 02. Comparison of Mean Scores by Category

Source: author

Table 03. Rank Order Scores

Rank	General Population				Expert Population			
	1	2	3	4	1%	2	3	4
Image A	16.7%	26.7%	18.3%	38.3%	20%	30%	45%	5%
Image B	10%	31.7%	40%	18.3%	35%	35%	20%	10%
Image C	58.3%	11.7%	15%	15%	35%	30%	15%	20%
Image D	15%	30%	26.7%	28.3%	10%	5%	20%	60%

General Population

Expert Population

Image A

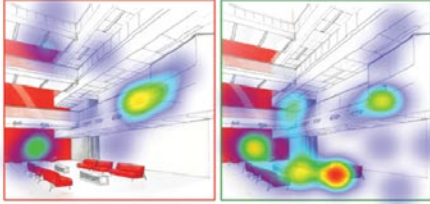

negative (left) positive (right)

Image A

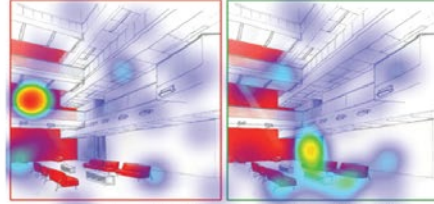

negative (left) positive (right)

Image B

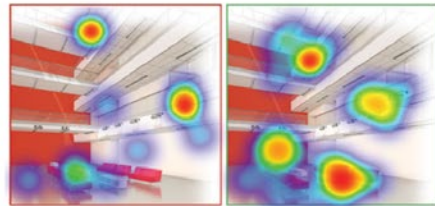

negative (left) positive (right)

Image B

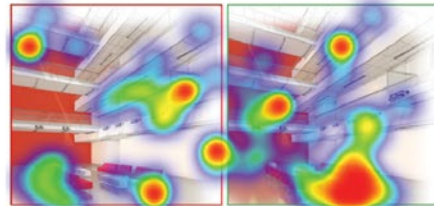

negative (left) positive (right)

Image C

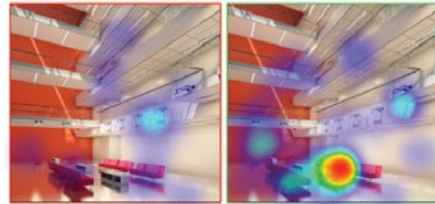

negative (left) positive (right)

Image C

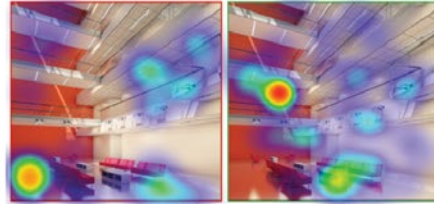

negative (left) positive (right)

Image D

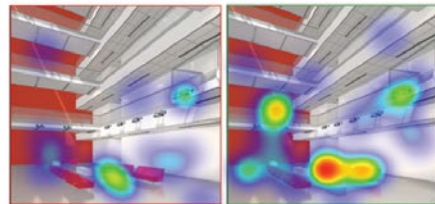

negative (left) positive (right)

Image D

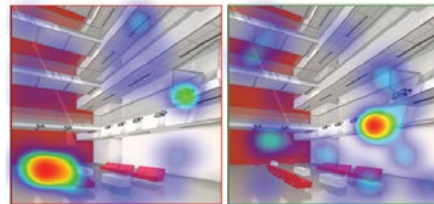

negative (left) positive (right)

Fig. 03. General and Expert Comparison via Heat Maps

Source: author

Heat Maps

Figure 3 shows heat map comparisons illustrating the respondent's perceived areas of strengths and weaknesses for each of the four images.

While the maps revealed relatively few distinguishable patterns in terms of media type, it is interesting to note that they suggested a higher engagement for Image B amongst both cohorts. This is despite the respondents being shown the images in a randomized order, which may suggest that Image B, garnered more attention and evaluation.

Implications

These results do present limitations. The subjective nature of aesthetic evaluations and this study's small sample size together suggest limited generalizability of these findings. More renderings should be evaluated to dispute or support themes from this study as outlined in the following:

1. **Findings suggest experts and non-experts evaluate architectural renderings differently.** This is evidenced in the relatively lower scores given by the expert population for all renderings, and the GP cohort's greater tendency to evaluate the rendering portraying the most advanced level of realism higher. In this study, the semi-photo realistic rendering (Image C) appeared to have the highest aesthetic value and emotional sway according to the GP cohort, who scored it highest in categories of potency, accuracy, and pleasure. This may be due to their lack of expertise in the built environment, such that it may be more difficult for them to 'imagine' design outcomes if presented imagery is relatively vague. However, advanced realism can be detrimental in design communication, especially in the early stages of design when there is greater potential for a client to mistakenly interpret decisions made for a rendering to be those of final design solution.
2. **Findings suggest that expert and non-experts evaluate *rendering accuracy* differently.** While the EP population scored the sketch (Image A) as more honest and natural, the inverse was true for the general population. This could be due to different interpretations of 'honesty' and 'naturalness.' The general population might be evaluating these measures based on a perceived fidelity to a final design outcome, whereas the experts may be making these judgements according to their experience in the design process. These different perspectives could be cause for miscommunication if designers mistakenly select a media based on incorrect reasoning.
3. **Despite differences, experts and non-experts appear to similarly evaluate *potency and pleasure*.** In this study, scores in the two categories followed parallel trajectories amongst the four renderings. This might be expected for potency due to its less subjective basis of evaluation (i.e. image saturation & level of detail), but is perhaps more surprising for the more subjective category of pleasure.
4. ***Arousal scores are difficult to measure.*** In this study, arousal scores in had the highest degree of variance. This could be due to limitations posed by using a survey instrument. As such, physiological measures such as eye tracking, electrodermal activity, and heart-rate might make for a more accurate measure.

Summary

While designers might prefer to use familiar tools (or those readily available), it is likely to their advantage to determine their goals prior to choosing the media to use for their architectural renderings. A rendering aimed at generating initial impressions should likely be different from one used later in the decision-making process. This understanding may become increasingly important, given the growing array of media types from which to choose and the persuasive sway of various media types should not be overlooked.

From Above the City

Introduction

“What we see is inseparable from the way we see it”¹

In Alfred Hitchcock’s illustrious movie ‘The Birds’ there is a striking shift in one of the scenes where the camera suddenly cuts to a perspective far above the earth level, providing a distanced view from the on-going chaos caused by the fire, after a bird attack on a fire-station. As the camera airs above it provides a re-positioning to the viewer, dissociated from the reality of the current events with the introduction of a fictional twist caused by the changing position of the viewpoint, which then will be followed with our eyes catching a bird’s eye; the moment when the watched suddenly watches back. The elevated look brings along not only a new position related to the content of what we observe and survey but also a new dimension to how we deal with and interpret the circumstances and events from above, from the eyes of another, from the birds, as is in the movie. And as often the case in cinematography, bird’s eye view is a tool for generating a distanced yet significant spatial position, which ascribes a certain level of triviality or a sort of sovereignty, an omnipresence to the on-going events on the earth level to the eyes of the observer. It compels an inspective flying gaze that is detached from the life on the ground, while stimulating a fictional aspect to the worldly matters to the eyes of the beholder, similar to what Hitchcock tried to achieve in the Birds movie.

Today we are in constant interplay with spatial positions that implies a downward looking gaze and shifting viewpoints as a consequence of urban imagery created and achieved by the technologic advancements in aerial or satellite imagery and photography techniques. Companies like Google Earth, Yandex Maps, Yahoo Maps or Bing Maps have enabled universal accessibility and contributed to the development of a new territorial and spatial understanding of the world’s cities. It won’t be wrong to say that today the role of aerial photography in our daily lives has become an indispensable personal and public tool for understanding, discovering and even experiencing the city and urban space. Yet, are we fully aware of the background influences of this medium; how it effects and reframes our understanding of the city, and how we position ourselves within the city. How this constant change in the scale of

¹ Schwarzer, Mitchel. *Zoomscape: Architecture in Motion and Media*. New York: Princeton Architectural Press. 2008. pp.16.

vision and also in the limits of vision, the two fundamental agencies in comprehending the qualities of space, affect our subjectivities and common spatial practices within the city, rather than causing a visual vertigo.

In the course of the technological progress, aerial satellite views have turned out to be a medium more commonplace than it ever was and it is no doubt that the way we think of and interact with the city and the way we navigate in the streets of the city is changing concurrently. From this point of view how could we define the utility of satellite imagery today in relation to other various more conventional visual registers we are more familiar with in understanding urban space like; maps, cartographic documentations, city plans or other more static aerial views. What meaning do we attribute to this new imagery and how does it change our understanding of cultural imagination, thus the relation of our experiences with time and space at urban scale. With an aim to discover the potentials and limitations that come along with this dynamic visual -and somewhat a virtual medium, the paper will attempt to provide an analysis on the specific features we got introduced with urban satellite imagery in terms of how we confront with and understand the city we live in. Furthermore, it will try to speculate on aesthetic and political statements that develop as the consequence of urban imagery produced by satellite views and their comparisons with particular urban satellite images in Turkey.

Elevated look upon the city has always been a central issue that bring out urban visions and manifestations even much before the widespread use of aerial or satellite views. Mapping and cartography practices were the only means of achieving the visual documentation on the city, where the territorial and terrestrial understanding inevitably have close associations with the governmental and aesthetic understanding of urban space. The fictive aspects of mapping practices rely mainly on the subjective observations and interpretations of the travellers or map-makers. The scale and the limits of this vision that later on translates to mapping were directly related to the observer's individual limitations related to his position and range of sight. Therefore, the visual language of mapping by its very nature provided certain ways to define our relations with the city relative to certain aspects that are conveyed through the map, like roads, public buildings, topographic features and etc. Each map conveys these elements in its own specific way, and consequently generates the meaning we attribute to the city through the elements it introduces, thus defining our location relative to its content. But more over it also implies our positions, movements and even experiences within the urban space relative to the mentioned edifices. Delineating certain elements more explicit than others has often been a conscious choice related to the mapping practices and how we define the boundaries of our cities, its territorial organisation and our life in relation to urban elements within our cities as well as how we define our cultural relations as a society.



Fig. 01. Map of Ankara, 1940s

Source: Department of Public Relations, Ministry of Tourism and Information



Fig. 02. Best NASA Pictures of Earth in 2016

Source: <https://www.nasa.gov/multimedia/imagegallery/index.html>

Technological advancements inevitably have affected the way we observe the world. In the course of aerial imagery of bird's-eye views or oblique views the air travels and the advent of photography have played a substantial role. Regarding the course of the earlier bird's-eye visualization and the twentieth century mode of air travel, the conceptualization of a mobile gaze over the city has never been a novel idea. Balloon travels as early as the 18th century and aeroplane flight starting with the 20th century have all increased this vertical and oblique perspective and enriched the potentials of this visual legacy. However, the early 21st century progress of the geographical information software, satellite imagery, had generated a correlation of the mobile gaze with the perceptual transformation of the built environment; as stated also by Schwarzer's book; *Zoomscape* "distinctive gaze over the city, where the important distinction between vertical and oblique perspectives is superseded by a view that zooms in and out, swoops and soars, and switches rapidly from intricate details to vast panoramas."² Looking down, in that sense, is no longer a passive act restricted to the frame of vision, as in previous aerial imagery but rather an experience that embodies a certain degree of independency and active response that demands an interactive performance from its users.

This is achieved as explained by the most common satellite imagery programme; Google Earth, which upon its first release in 2005 has become one of the widely used geobrowser that accesses satellite and aerial imagery ocean bathymetry, and other geographic data over the internet to represent the earth as a three-dimensional globe;³ as follows, "Google Earth offers the viewer the conceit of flying over the earth at altitudes ranging from outer space (nearly 16,000 miles) down to less than 100 feet."⁴ The visuals constituting the facet of the 3D globe, is like dressing-up the blue marble, comprise of a variety of photographs either captured from the space satellites or of

² Schwarzer, M. op. cit. 90.

³ https://en.wikipedia.org/wiki/Google_Earth (accessed 22.03.2017)

⁴ Cosgrove, Denis; Fox, William L. *Photography and Flight*. London: Reaktion Books. 2010. pp. 77.

aerial images and enriched with greater detail taken from lower-altitudes. All the geobrowsers provide you a flexibility to shift your perspective among the roof of your house to the city as a whole, from intricate details to vast panoramas with few clicks. Therefore, it won't be wrong to proclaim the long zoom that brings along a constant scalar shift as the most characteristic visual paradigms of our time.⁵

Zooming in and out is achieved by the developed technologies of air imagery which enables one to travel above the earth but its more about the way the programmes gathers this visual information through superimposing a plenitude of cartographic layers that all comprise a unique set of information. This is reminiscence of the broadly quoted Borgesian story or the famous reference to the narrative in Lewis Carroll's *Sylvie and Bruno*, where there is a fictional map that ended up having a scale of a mile to mile. The dispute on the practical difficulties of this map was narrated by one of Carroll's characters as; "*the farmers objected: they said it would cover the whole country, and shut out the sunlight! So we now use the country itself, as its own map, and I assure you it does nearly as well.*"⁶

Google Earth has realized the fictive utopias in these narratives, as reconfiguring the Earth we live in as a multi-layered surface where a boundless range of data is both attained from, and concurrently inserted onto by the users. So as in the words of Verkaik, "Google not only gives you the world but it also gives you yourself"⁷ It is the hybridization of information on the city that you also participate to its nature of accumulation. It is of course not only the images of Earth that are gathered together but a vastly extended interactive data-scape that is often in a reasonable resolution, composed of multi-layered information that requires searchability and manipulations. These images, which were once available only to military or government agencies, now becomes a common tool that enables to see and read things that might not otherwise be legible by zooming in and out.⁸

Within this infinite array of perspectives and unexpected juxtapositions the fictive character ascribed to the city gets even stronger. And the source of this multi-layered information that coats our cities is these interactive relations we all set with the urban images and our particular experiences with them. The shifting scales of vision, or the dynamic gaze introduces new perspective to territorial conceptualisations, and with political implications, as will be discussed in the following paragraphs in detail. The surveying eye and the surveillance eye, in the nature of each have diverse connotations on the subject that is being seen and observed. This omnipresent position implies a "God-like but as vertiginous, betraying a mixture of mastery and anxiety in the relationship between viewer and the city."⁹ In this scenario architectural details start losing their sharpness and merge into a cluster of urban entity, presenting an architectural space that is more graphic or geographic than spatial.

⁵ Johnson, Steven. "The Long Zoom". <http://www.nytimes.com> (accessed 13. 01. 2017)

⁶ Carroll, Lewis. *Sylvie and Bruno Concluded*, London: Macmillan & Co. 1895. pp.170.

⁷ Verkaik, Robert. "Google is Watching You". *Independent*, 24 May 2007. pp.1-2; p.2.

⁸ Felicity Scott, "Making Data Speak," in Gretchen Wilkins, ed., *Distributed Urbanism: Cities After Google Earth*. London: Routledge. 2010. pp. xii.

⁹ David Gilbert, "The Three Ages of Aerial Vision: London's Aerial Iconography from Wenceslus Hollar to Google Earth," *The London Journal* 35.3. November 2010. pp. 296.

While the mobile gaze that zooms in and out causes a constant change in the scale of vision, thus a different spatiality, the possibility to acquire former images of the earth enables a travel in time; yet a different relation with the object of vision; the city. Not every programme provides this possibility apart from GoogleEarth, which alongside various other features like Google Sky, Google Ocean also has started offering Historical Imagery. With this new application of Historical Imagery Google Earth provides visual sources as in time-lapse captures that display the changes in the earth surface topography and the cities, like a historical mosaic. This new additional feature besides drawing attention to a global awareness to the changes in the natural sources of the earth attains a transcendent position to its viewer, who can now survey any particular city's past, enabling multiple readings on the city's changing topography to be performed simultaneously. So we not only observe the city from above, with an elevated look or zoom constantly in and out to change the scales of our perception but we can have the change to be able to travel back and forth in time, observe the chronological course of urban and rural transformations within the last few decades. This new layer of data is actually a new level of information added to the already loaded layered coat of the globe.

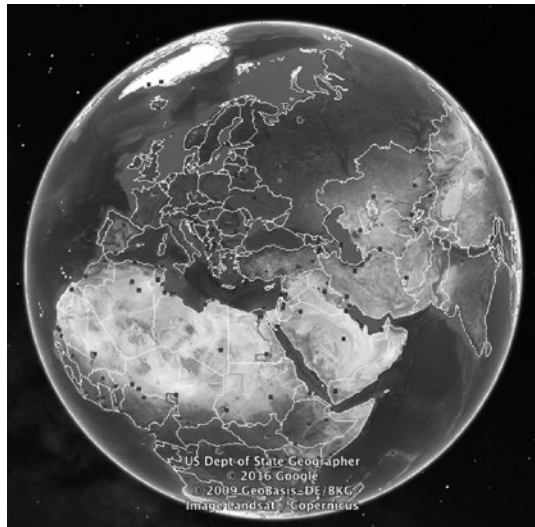

Fig. 03. The view of the globe, 2017

Source: Google Earth

All these layers of information and how this information is processed on Google Earth have two major consequences, which inevitably effect our understanding of urban space. One; is the way all these layers assist in generating a totalitarian global image of the earth. In our vicarious relation with the earth, there inevitably rises a sense of it as a networked single cosy place. Secondly, the programme also entails not only the effect of how the programme displays the earth or the globe but also our relationship with the programme. As emphasised also by Mark Dorrian, this visual rhetoric of the world no longer enunciates the wholeness of the object but rather the wholeness of its searchability, as everything that may block the vision in reality is

completely eliminated and as he calls it drained away from the network of images.¹⁰ All the patchwork of image data and information gathered from multiple various resources aim to achieve not only a total global affect as such but also imply the opportunity for an unobstructed gaze from every scale. The clouds that may block our view at certain proximities to the earth level, the adjustment of visibility of the earth with regards to the presence and absence of sunlight or the shadow effect of certain objects on others are all eliminated for the sake of an unrestricted vision and perpetual surveillance.



Fig. 04. Satellite Image of Ankara, 2016
Source: <https://yandex.com/maps>

The clarity enabled by the search engines of Google Earth consequently implies a world image that denotes a particular kind of notion of the globe. Manifestation of the terrestrial surface of the earth as a media surface that compels manipulation creates a new condition, where the rules are redefined either by market values and consumerism or national security, the two notions, which seldom come together. What is meant with this new condition is closely related to our relationship with the programme as well as its claims for informative visual resource of the earth. It is what Dorrian calls; as the politics of resolution. Google Earth presents us a new kind of political map, structured with a rather different logic than those previously accustomed maps or cartographies organised by the vectors of national boundaries. In here we come to experience a new political map structured through image resolutions and the upload periodicity of data sets.¹¹ Consequently all the revealing approach to the city opposes with political resolution dilemma that turns the urban space to a patchwork of blurred or blackout images under the politics of resolution due to national security issues in many countries. Certain cities of countries like South Korea, Israel, Malaysia censor substantial parts of their city's satellite/aerial imagery. Turkey is subject to a similar

¹⁰ Dorrian, Mark. "On Goolge Earth" in *Seeing from Above, The Aerial View in Visual Culture*. London: I.B. Tauris & Co Ltd. 2013. pp.299.

¹¹ Dorrian, M. *op. cit.* pp. 301.

strategy for certain zoom levels in satellite images of its cities to be either missing, blurry or completely blotted out countrywide. So, on one level there are countries where the cities stand out with polished and bright high resolution satellite imagery and there are countries where cities configured with dark spots, low-resolution patch-worked fields and dark blots. Where the limits of visibility don't change with the practice of zoom in and out but facilitates rather with certain political and trade guided concerns and their reflection on the earth's digital skin. We now see on one end the re-foundation of democracy¹² and a new branding mechanism that serves for similar ideas and its fall by the facilities of the same programme concurrently.

Conclusion

“The gaze does not emanate from the eyes of the subject looking, but from the object that is looked upon.”¹³

We got accustomed to observing the world through technological frames for a very long time now. As we become more and more data driven in our daily lives Google Earth has a particularly significant role in this scenario and it has probably far outstripped the initial goals of its developers. It is impossible now to limit the potentials of the programme as a medium for providing a privileged, detached positions for interpreting the earth's surface from above, unbounded from the concerns of time and scale. Its' very presence as a medium that welcomes mass accessibility and unbounded searchability turned it into an agency that is not founded solely on the limits of visuality, but rather a phenomenon that have significant effects on how we conceptualise urban space and how we relate to it. It has not only strengthened the idea of the global but also initiated a new form of social interaction through redefining the idea of territory and boundary. Since high walls are no longer constitute barriers to the public gaze in the age of Google Earth but it rather implies constant play with our understanding of what is interior and exterior and also what is intimate and what is not. It is tellingly, a kind of ‘reversal of Bentham's panopticon’, where it is the prisoners who are constantly observing themselves from different positions. So maybe it is true that the aerial view seems more exposed and therefore democratic than other forms of digital imagery.¹⁴ But yet it never is a global democracy. The satellite imagery and especially Google Earth as the leading programme, may have defied the laws of time and space and offers a flight free of these constraints but on the other hand it executes a world that is fragmented politically through the diverse resolutions and black blots. A democracy defined either on exposure or else censorship.

But if we are to argue today that the tools of architectural production are highly

¹² Democracy is the name of the diorama, which was housed by the Perisphere and the Trylon that were designed by architects Wallace Harrison and J. Andre Fouilhoux for New York World's Fair in 1939. The architects tried to depict a utopian city of the future through their design that consists of an interior display, which was viewed from above on a moving sidewalk, alongside the multi-image slide presentation that was projected on the dome of the sphere.

¹³ Lacan, Jacques. *The Four Fundamental Concepts of Psychoanalysis*. 1st. New York: Norton, 1998. pp:95.

¹⁴ David Gilbert, “The Three Ages of Aerial Vision: London's Aerial Iconography from Wenceslus Hollar to Google Earth,” *The London Journal* 35.3. November 2010.pp. 298.

integrated with those of cultural production, then the culture proposed with the satellite imagery in terms of new social relations and territories, get inevitably affected. The constraints and censorships achieved through these agencies not only restrict our vision but also hamper our right to be an urban dweller or a citizen that build up the urban culture through a network of social relations. So, it is not an attack to the limits of our gaze but to our presence as urban entities. And the last but not the least, to return to Hitchcock's movies again, it is interesting to realise that as in Bird's movie and his many other films the notion of fear is attained through the unseen. Zizek calls this manoeuvre as Hitchcockian Blot,¹⁵ which is a phenomenon achieved mainly through the constant play between the seen and the unseen and invisible, and there is a lot to be said on the direct reflections of this condition on the notion of existence, or being present and not.

Bibliography

- Cosgrove, Denis; Fox, William L. *Photography and Flight*. London: Reaktion Books. 2010.
- Schwarzer, Mitchel. *Zoomscape: Architecture in Motion and Media*. New York: Princeton Architectural Press. 2008.
- Zizek, Slavoj. *Looking Awry: An Introduction to Jacques Lacan Through Popular Culture*. Cambridge, MA: MIT Press. 1998.
- David Gilbert, "The Three Ages of Aerial Vision: London's Aerial Iconography from Wenceslus Hollar to Google Earth," *The London Journal* 35.3. November 2010. p. 289-299.
- Lacan, Jacques. *The Four Fundamental Concepts of Psychoanalysis*. 1st. New York: Norton, 1998.
- Dorrian, Mark. "On Goolge Earth" in *Seeing from Above, The Aerial View in Visual Culture*. London: I.B. Tauris & Co Ltd. 2013. pp.299.
- Felicity Scott, "Making Data Speak," in Gretchen Wilkins, ed., *Distributed Urbanism: Cities After Google Earth*. London: Routledge. 2010. pp. xii.
- Carroll, Lewis. *Sylvie and Bruno Concluded*, London: Macmillan & Co. 1895.

¹⁵ Zizek, Slavoj. "The Hitchcockian Blot". *Looking Awry: An Introduction to Jacques Lacan Through Popular Culture*. Cambridge, MA: MIT Press. 1998. pp.91.

Understanding and Developing Meaning in Design: Abstraction and Meaning

In order to develop meaning in design, I believe that a “useable” understanding of abstraction is necessary. I define abstraction as a “decrease in blatant realism creating space for an increase in information. I define meaning in design as that information pertinent to the context and program that is abstractly represented in the work. Abstraction and meaning are not well understood by design students however they must be. The design student’s work is abstract, whether they know it or not, unless it is of some known classical style, which could be argued, is also abstract at some level. When asked to define abstraction for example, students will respond that it is something that is strange or different. This may be the case, however, that is not a useful definition of abstraction. Abstraction as it relates to a design process is the removal of representative information to the point that the initial subject is still understood and in the place of that which is removed, additional information relating to and expanding upon the original subject is added. The removal process creates space, maintains original subject information and allows much additional information to be transmitted. This process transfers meaning to those observers of the product or piece. There is tremendous power in abstraction that needs understanding.

In architecture and related design fields, our work is abstract and analytical. If it was representational, it would be classical and there would be rules to the classical style being worked in. To understand and work with analytical abstraction allows students and designers alike to “design in” meaning that can add to the joy and excitement experienced by viewers and users of the work. What meaning does a designer build in to a design? An analysis of meaningful contemporary architecture, with an understanding that contemporary architecture is “an abstract representation of something contextual, something programmatic and often something of the designer’s ideology.

Architectural or other art based design is a complex process/scenario of components and the teaching of design takes years of intense studio instruction with a phased educational structure. Basic two-dimensional design, three-dimensional design and color theory are often the beginning components of this process/scenario along with writing/thinking skills. Writing skills help students probe and organize the complexity of thoughts necessary to perform an art based design. Visual thinking and perceptual cognition skills become apparent in subsequent semesters along a path to the development of a substantial working design process. The product of a thorough

design process is free-flowing idea generation, which is rational and logical and also irrational and illogical at the same time, which a free and open idea generation process should be.

The development of this process necessitates, at various times, the development of an orderly approach or at least a conscious organization of thoughts about a specific problem or set of problems at hand. These skills are taught at every level of the design studio scenario. Additionally, an understanding of what individual design thinking is in relation to historical precedent is necessary. What seems to be widely misunderstood or ill-explained is an understanding of exactly what abstraction and meaning are in design and how vital an organized understanding of abstraction and conveyance of meaning are to three-dimensional form.

Abstraction and meaning are not well understood by design students and they must be. When asked to define abstraction for example, students will respond that it is something that is strange or different. This may be the case, however, that is not a useful definition of abstraction. Abstraction as it relates to a design process is the removal of representative information to the point that the initial subject is still understood and in the place of that which is removed, additional information relating to and expanding upon the original subject is added. The removal process creates space, maintains original subject information and allows much additional information to be transmitted. This process transfers meaning to those observers of the product or piece. There is tremendous power in abstraction that needs understanding.

An illustration of this is a photograph of a person close up. We would see the person and would be able to identify that person easily. Because this is a photograph and not the actual person, there is a level of abstraction, albeit simple. Now if the photographer backs up a distance, the photograph will still contain the person, however, more information is added about the surroundings, foreground, background and the original subject, thus a higher level of abstraction and now much more meaning is transmitted to the viewer.



Fig. 01. Abstraction Photo Example

Source: author

The person, however, is still identifiable. If the person was a student in a classroom, the first photo would show the student, the successive ones where the photographer

backs up, would add more information about the desk the student is sitting at then the student and classmates surrounding the student, then the student, the classmates and the room they are in and perhaps what class they are in, etc., etc. until reaching a point of being “too abstract” i.e. the photographer backs up so far that the original subject, the student, can no longer be identified, hence the meaning is lost.

In the late 1800’s, there was an explosion of analytical direction in creative endeavors perhaps first seen in the “Monument to Balzac” sculpture by Rodin and later his well-known piece “The Thinker.” In those pieces, representative visual information was removed and additional visual information was inserted. No longer did a sculpture look exactly like the subject - a warrior on a horse is a warrior on a horse - but analytical questions were raised by the viewers. Why did Balzac look like he did? What was under that cape? Why would he be hiding something? What was the “Thinker” thinking about? Why was he naked and why did his muscles look distorted? By removing some of the representational information, Rodin inserted visual information that was transmitted to viewers, i.e. analytical abstractions and no longer pure representational work. Is it coincidental that Sigmund Freud’s analytical work was published during the same era? Thus began an exploration into the world of analytical abstraction; taking away too much realism resulted in mis-understanding, leaving too much resulted in boredom.

In architecture and related design fields, our work is abstract and analytical. If it was representational, it would be classical and there would be rules to the classical style being worked in. To understand and work with analytical abstraction allows students and designers alike to design in meaning that can add to the joy and excitement experienced by viewers and users of the work.

Developing Meaning - Information Modeling

“Information modeling” simply means to display information graphically, similar to diagramming. The “Open Response Model”, is a very specific form of information modeling. It is a powerful graphic technique that is useable as a “process,” a feedback and check mechanism and as a “product”. How does one understand what meaning a piece should possess? What level of abstraction does the piece possess - too much or too little? Can the intended meanings actually be understood by viewers? By using an open response model as a design tool, a designer can be assured that the level of abstraction and the meaning transferred are appropriate for the problem at hand.

The Information Model is used to develop the information that the designer will utilize as the meaning in the design, specifically it:

- probes for information
- displays information
- organizes information and subsequently:
- categorizes information/the meaning that will be used to design.

All of this is about a design project, in a very specific way. The word model takes a design problem definition and in three successive steps, calls for increasingly

more defined levels of information about that subject. The information is categorically more and more specific from left to right until the smallest pieces of information are displayed. Within the design process, it is quite possible to forget, misplace, or not even process certain bits of data and information which can affect the design result. The data may be: form implicit, having to do with the physical nature or substance of the solution; or may be behavior implicit, having to do with the behavioral patterns resulting from the way the space works. In each case, the data holds “Form Generating” power that becomes meaning in the design, if gone unprocessed, could result in an incomplete design solution.

The objectives of the Model are to exhaust, in as methodical a way as possible, the data at hand leading to an organized display of all pertinent information about the subject. This is a bit tedious at first, however, the importance lies in the rigor of its discipline; demanding that the designer assume a “third person” role at the outset and demanding that every shred of information be observed and subjected to scrutiny. The designer is, of course, “engaging” the problem first hand. Great value lies in the completed display which serves as a testament to the process but also serves as a mechanism to test the future design solutions proposed, for completeness and appropriateness. This process is therefore “Experiential” and “Referential”.

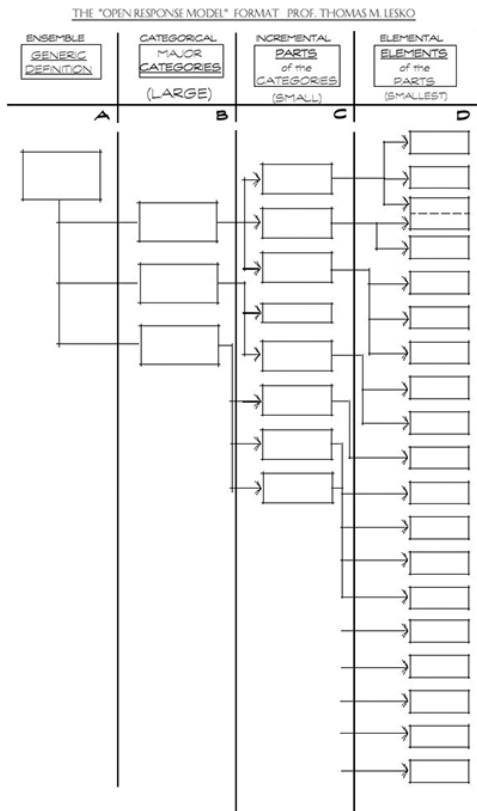

Fig. 02. Information Model Format
Source: author.

Steps in the process

A: Generic Definition of the Problem

The first step is to define the project using a generic phrase that describes it in its entirety. This first step allows the designer to become free of preconceptions relating to the problem. In this step, the original problem must not even be written. In this sense, a “church” becomes “a space devoted to the support of collective meditative and reflective activity” or something to that effect. Imagine this problem: you are to design a coffee cup that does not look like any other coffee cup that exists. Just saying the words “coffee cup” conjures up all the coffee cups that you have seen or used in your life. Why be hindered by those pre-conceptions? A “coffee cup” thus becomes “a container for hot, brewed liquid” and that original term is no longer a part of this effort. As one can observe, this generic definition creates an openness to possibilities that might otherwise not be considered when hindered by pre-conceived notions that the original word or phrase contains.

B: The Major Categories of step A

Each problem defined in “A” has significant, overriding characteristics. These characteristics might be physical (size, weight, color, character, content, location, ambivalence, empathy, etc.) or they might be behavioral (gather, collect, isolate, accelerate, etc.). The task here is to break apart the problem into its major constituent parts and no more. As shown in the graphic format, this category contains two or three entries only.

C: Parts of the Categories of step B

This is a listing of the nature of each major category listed in B. What forms contribute to them in the physical sense, and what sub-activities characterize them in the behavioral sense? Begin to describe the categories in terms of scale, dimension, identity, quantity, character, etc. but realize that there is one more category that will contain the smallest parts. There is almost always the necessity to edit and revise these last two categories. Once information is displayed, one can react to and judge the nature of the information and re-categorize the information as necessary. This is a process, several edits are normally required before the proper relationships are achieved.

D: Finite Elements of the Parts of step C

This lists the smallest possible element of the parts listed in C and serves to be definitional of those elemental parts in a physical or behavioral sense. These entries represent the smallest constituent part that can be observed and having form generative value. Again, remember that this is a process and that numerous edits, additions, subtractions and re-arranging of information will be required.

Once this information is displayed, reviewed and edited, the final result is a visual display of organized information that is form implicit and that represents the meaning the final designed product should have and that can be communicated to the user/observer. From here on, this visual word model represents all that will become

the product. The model is read from left to right when beginning the design process and from right back to the left when, during the design process, some clarity and simplification is needed. Often times while designing, casual steps backward must be taken to clarify conceptual intent. This model will facilitate those steps and act as a checking mechanism to maintain focus and design intention.

Conclusion

There is a natural tendency to discount the value of such a tool as the open response model, but consider that with this one simple tool, a designer can probe for information relating to the design problem at hand, organize that information into a very useable format and use the ensuing model to check one's progress and validity of the design product. All with one simple tool. If the designer cannot, by the end of the process, define the design as per the word model format, then what meaning is the designer intending to communicate? The display of words in the four categories becomes the intended meaning to be communicated in the final design. This tool in many ways facilitates the definition of a design conceptual statement. A concept statement can be made regarding the design but that statement must be defined in finite terms and should include the information inherent in the word model. This may not be the tool for every project, however, the information it contains is the intended meaning to be woven into the visual attributes of the final work to be understood by users and viewers of the architecture.

Bibliography

- Curtis, William J.R. "Modern Architecture Since 1900". Phaidon Press, Oxford, 1987.
- Gombrich, E.H. "Art and Illusion: A study in the Psychology of Pictorial Representation", Princeton University Press, Princeton, 1972.
- Arnheim, Rudolf "Art and Visual Perception", University of California Press, Berkeley, 1974.

Michael Knight ^a, Wolfgang Dokonal ^b

^a School of Architecture, University of Liverpool, UK

^b Graz University of Technology, Graz, Austria

The Right Bike at The Right Time: a brand new (old) interface for VR

Introduction

Recent advances and developments in low cost VR hardware (e.g. Head mounted displays HMD), in particular those that use mobile phones as a computational head mounted device together with recent software developments, have given architects and designers new opportunities to use VR as part of their toolbox. With the continuing rise in interest and availability of VR seemingly in all sectors of life, low cost VR interfaces start to be of increasing relevance to architecture. The new changes in the whole system are driven by the interests of the gaming industry and today this a powerful and economically flourishing industry with a great deal of available resources. This paper combines a reappraisal of an older project and revises/updates it with the findings of more recent work and tries to address the old problem of “using the right tool at the right time”.

Developments in display and tracking technologies continue to draw headlines, but for architectural use, the way we interact and interface with the virtual space is of equal, if not greater importance. Our conjecture is that to experience a virtual space in a believably immersive way, we should be able to navigate it in as natural manner as possible - using a mouse or proprietary controller to experience architecture is only a partial and often unnatural solution. Ideally, users should be able to replicate their natural movements in the virtual world.

The project to use a “mechanical finger” (Dokonal, Knight, Dengg 2015) to translate the movement of feet walking in the real space into the virtual world turned out to deliver very promising results.

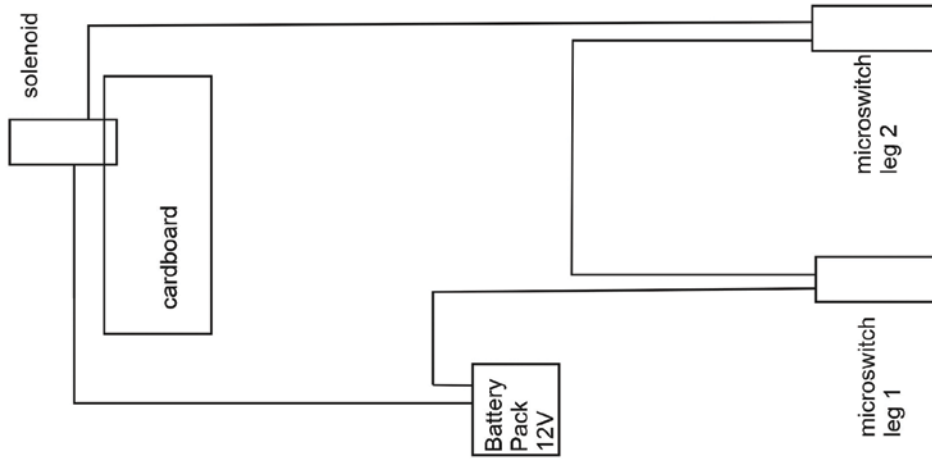

Fig. 01. eeZee Click concept diagram

The main advantages of this very low tech version was that it was completely independent in space – there was no setup with a limited tracking area necessary – the system can be used everywhere the limits are only the available real space and the possibilities of the smartphones. Neither the limitation of cables tethering the user to a fixed computer nor the rather limited tracking areas of other HMD systems are an issue here. Additionally, eeZee click used only the basic sensors in the smartphone so the problem of different smartphones behaving differently was overcome. Gaze determines direction of navigation i.e. whilst wearing the Google Cardboard headset, the direction of travel is determined by where the user is looking. The sensors for the movement were attached to the users’ shoes. It was really striking that this very low cost idea gave a much better feeling of immersion than walking by pressing a button on your HMD device or being transported by staring into a corner. We used the system mainly for interior spaces but we discussed the possibility to use it also in an urban setting. During our first attempts, we found out that walking a city is very effective but sometimes it would be good to be able to move a little faster – such as using a bicycle.

It seemed appropriate to revisit the nAVRgate project from 1999. (Knight and Brown 1999-2001) The Project was an attempt to use a modified exercise bike to be able to cycle round urban environments in front of a projected screen. It took inspiration from Jeffrey Shaw and the Legible Cities project (1988), but constructed in the spirit of low cost/home brew computing. Users used a familiar metaphor and ‘rode’ the bike whilst sitting in front of a large projected image which extended beyond their field of view. They were, within the restrictions of the screen size, able to move their heads to alter their view, but it was a 2D image which naturally reduced the immersive effect. More seriously, due to physical movement scaling problems (caused by a lack of configurability in software drivers) the handlebars in a rather less than natural manner requiring 90 degrees of movement for only 45 degrees on screen. The system used the proprietary games engine ‘Unreal’ to generate the environments which was good for the time (and exceeded user expectations), but current software has advanced significantly not only in terms of quality of real-time rendered graphics, but also in

the degree of flexibility and customisation options. Despite these problems, it was very successful in terms of the overall degree of immersion that users experienced compared to other methods.

So, the idea was to combine the mechanical finger idea with the idea to use an exercise bike, taking advantage of more recent software configurability and more recent technology. The idea of riding a real bike in real space with HDM devices was quickly abandoned – we already experienced with our original mechanical finger test that the real world can have rather hard boundaries. The exercise bike idea was much safer idea. So the main problem was to bring the micro switches from the shoes to the bike and to define the speed of movement triggered by the switches. To give a natural feeling we wanted the bike to move at a rather leisurely pace through the cityscape.

Additionally, we wanted to attempt to establish a gear shift possibility so that we can change the pace of movement in the virtual world but still keep the same speed of pedal movement in the real world, however time constraints meant that this has been deferred to the next (fine tuning) stage of the project. So our interest in natural interfaces at a low cost price continues. Whilst there are commercial devices such as the Virtuix Omni, these are priced at a level which falls outside the definition of low-cost. We have revisited nAVRgate and used our experience of more recent work with an ultra-low cost walking interface that has proved successful. This again was in the spirit of DIY/homebrew computing. This paper reports on the updating of the original bike with the newer technology that allows some of original problems to be overcome. Rather than using a projected image, the revised system is designed for use both with Google Cardboard and more high-end devices in the form of the HTC Vive. In combining these projects, our aim remains the same – the creation of an accessible, low cost VR environment in the spirit of the home-brew computing pioneers. The advantage we have today is that it is relatively easy to ‘upgrade’ this with the use of commercially available HMDs.

The eeZee click system

The system presented here comprises of two separate but linked modules. The first part developed was the walking interface which tested the natural, untethered walking metaphor. In its unmodified state, the Google Cardboard headset requires the user to repeatedly press a button to move. In reality, the button is a simple lever with a conductive end which simulates touching the smartphone screen. Our system added a 12v solenoid to the headset which is activated by micro switches mounted on the user’s shoes. Moving the feet in a natural way activates the solenoid, ‘tapping’ the screen and creating moving the virtual environment. In the spirit of the materials of the headset, first version used a cardboard mounting system and a less powerful solenoid than the second version. One problem encountered was the amount of heat generated by the 12v solenoid, so in the final version, a more rigid mounting system was used with a heat sink. The drawback of this was that it was considerably heavier and in reality the solenoid was too powerful.

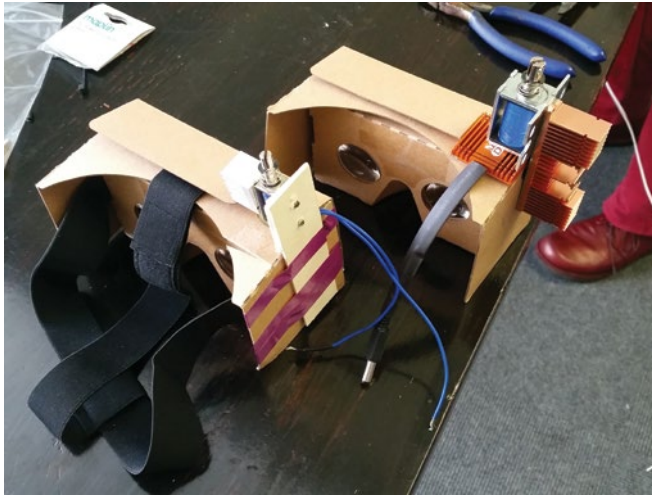

Fig. 02. eeZee Click Cardboard HMD

The cycling interface is a development of the original NAVRgate system (Knight and Brown 1999-2001) which had some significant disadvantage largely caused by the lack of suitable low cost resources when originally developed. The original system used a modified optical mouse circuit board (modified with a hacksaw to separate the X and Y movement components) and the movement was achieved through a series of gear wheels which activated the optical sensors. The handlebars steered in the Left and right in the X axis and the pedals moved forwards and backwards in the Y axis. In eeZee click, the user moves in the direction in which they are looking, removing the need for the handlebar movement. In the spirit of eeZee click, the forward movement is activated by a micro switch mounted on the frame. A battery pack (also frame mounted) completes the system.



Fig. 03. Revised naVRgate bike



Fig. 04. User using eeZee Click

For the complete system, the user is fitted with the foot switches (using mapping pins to fix the switches to shoes), the battery pack is placed in a pocket and the headset is connected to a power connector on the headset allows a quick change between walking and cycling.

Unity3D was used to create the environment with two scenes containing the same 3D models. The only difference between them was the slower speed of movement to differentiate between ‘walking’ and ‘cycling’. Currently, the switch between the two modes is manual, in final system, it is planned to have an automatic switchover.

For testing, we used a mixed group of students from both TUGraz and University of Liverpool. They had created models of their own student accommodation – environments with which they are familiar. They used both the eeZee click system and Google Cardboard and propriety software on an HTC Vive which used teleporting as a navigation metaphor. For eeZee Click, Google Cardboard application files were created on Unity and the students used their own mobile phones as viewing devices. During the workshop, we had no time to experiment with different speeds of movement, but this is easily achieved in Unity.

HTC Vive system

The HTC Vive represents the high cost end on the VR headset market and is used here as comparator to Google Cardboard used with eeZee click. Having two tracked controllers, it uses a ‘teleport’ metaphor for navigation where users select a visible point to move to. The user moves to that point with the screen rapidly fading as the move happens to prevent motion-sickness. An application called Symmetry was used as it loaded SketchUp files natively which removed a level of complexity (i.e. a dedicated gaming environment such as Unity was not required). The students viewed their apartment models plus a larger scale urban environment.

Survey

We recorded their comments in a survey with questions relating to how their experience of the real apartment matched the virtual world, how realistic the navigation felt, degree of immersion and any motion sickness experienced.

The survey results confirmed that eeZee click gave an increased level of immersion and that the navigation metaphor was natural. Some of the comments were more related to other aspects of the system (e.g. the capabilities of a mobile phone to display a complex VR environment smoothly) whilst another “*It’s difficult to suggest possible improvements as it would likely defy the idea of being a low-budget VR-System.*” is more accepting of the low-tech nature of the system.

The bike had slightly more critical results which suggest that more fine-tuning is required. Although the speed was increased over walking, movement was not sufficiently fluid to be considered natural. In the original nAVRgate system, the handlebars controlled the direction of travel – this was replaced here with fixed bars and gaze directed movement. Some users commented that this felt slightly unnatural and was a minor distraction in that they felt the bars should move. So, whilst the degree

of immersion was still increased over the standard Cardboard, one user commented *“during cycling the cardboard was shaking quite a bit, also the cycling speed is very slow which is giving the impression of not really moving forward, it is a bit strange to move your head and not be able to steer”*. So it is clear that the original naVRgate metaphor of steering is considered more natural. However, this would not be possible using the current eeZee click as it would require the adaption of a low cost Bluetooth games controller to add a third level of control (gaze for view direction, Cardboard click for forward movement and Bluetooth for direction control). This may form part of the next stage of development.

Discussion

The questionnaire confirmed informal feedback that walking in eeZee click was natural and easy to adapt to. Users could either walk using real steps (although a minder was required to prevent accidental collisions with the real world) or, more commonly, they walked on the spot. The exercise bike was not quite so successful and needs more work, but is fine tuning rather than a wholesale rethink. It is now clear that separate models are required for walking and cycling

With regards to the headset (which was common to both walking and cycling), some commented that the weight of the solenoid on just one side of the headset made for an uncomfortable experience particularly given the rather basic nature of the Cardboard headset with no padding. The noise of the solenoid activating was also commented on as being distracting by some and valued by others who found that the sound of the solenoid gave them an almost physical connection with the virtual movement.

Users quickly adapted to the teleport navigation of the Vive although the learning and familiarisation period was considerably longer than eeZee Click.

Conclusions

Given that eeZee click cost a total of £30 (excluding a mobile phone which nearly everyone has and the exercise bike from naVRgate which had originally recycled from a charity shop) and the Vive is nearly £900 and needs a very powerful computer, our faith in the effectiveness of ultra-low cost VR systems has been vindicated. There is no doubt that the Vive offered a much more ‘luxury’ experience (in the same way that an up-market car is more luxurious than a budget model), both get the job done but in different ways. System such as eeZee click democratise VR and make it a genuinely useful tool in the design process.

Outlook

There is still a lot of research necessary to fulfil the initial goal that we had in mind to provide a platform for every architect to use VR as an additional design tool in the design process. The idea is that using this kind of software should be as easy as using any other App on the smartphone – no need for special software skills. Having a template in unity with readymade scripts that produce the geometry as an

App to be used in the smartphone seems to be very promising. Our students had no special software skills and most of them used Unity for the first time but it turned out to be no problem for them – they all managed rather quick to produce the app out of their geometry – although they had different filetypes for input. We had models from Archicad, Sketchup, Rhino and Revit. A bigger problem are software updates and software versions. For example, it turned out that different versions of the Android APK's behaved differently depending on the version of Android that was running on the smartphones and we spend a substantial amount of time to overcome these problems.

The eeZee click system itself has still room for improvement. At the moment we are working with google cardboard systems and the solenoid mounted on top of them. A more customized version of cardboard tailored to the eeZee click system will be a possibility for the future. Then we can position the solenoid in the middle of the HMD and avoid having to much weight on one side. Additionally a customized belt that contains the battery pack and oversized overshoes that you can use with your normal shoes are concepts that will make eeZee click quicker and easier to use.

For the bike the problem of “the right speed at the right time “still has to be solved. On the one hand it will be quite easy to produce Unity templates with different sizes of movement on the other hand there is no solution yet to “change gear” in the virtual world – you would have to change to a different version of your geometry app. A combination of the eezee click movement and the teleporting feature sounds promising because sometimes you don't really want to cycle in real speed through the city – too much exercise....

So we still have several problems to solve but eeZee click and the bike has the potential to become a valuable tool for anyone designing in the field.

Bibliography

- Anette Kreutzberg (2014) *New Virtual Reality for Architectural Investigations*, Thompson, Emine Mine (ed.), Fusion - Proceedings of the 32nd eCAADe Conference - Volume 2, Department of Architecture and Built Environment, Faculty of Engineering and Environment, Newcastle upon Tyne, England, UK, 10-12 September 2014
- Dokonal, Wolfgang; Knight, Michael W. and Dengg, Ernst Alexander (2015) *New Interfaces - Old Models*. Martens, B, Wurzer, G, Grasl T, Lorenz, WE and Schaffranek, R (eds.), Real Time - Proceedings of the 33rd eCAADe Conference - Volume 1, Vienna University of Technology, Vienna, Austria, 16-18 September 2015, pp. 101-106
- Freitas, Márcia Regina de and Regina Coeli Ruschel (2013) *What is Happening to Virtual and Augmented Reality Applied to Architecture?*, Open Systems: Proceedings of the 18th International Conference on Computer-Aided Architectural Design Research in Asia (CAADRIA 2013) / Singapore 15-18 May 2013, pp. 407-416
- Knight, Michael and Brown, Andre (1999) *Working in Virtual Environments through appropriate Physical Interfaces*; Architectural Computing from

- Turing to 2000 [eCAADe Conference Proceedings / ISBN 0-9523687-5-7]
Liverpool (UK) 15-17 September 1999, pp. 431-436
- Knight, Michael and Brown, André (2001) *Towards a natural and appropriate Architectural Virtual Reality: the nAVRgate project*. Past, present, future. Proceedings of the Ninth International Conference on Computer Aided Architectural Design Futures [ISBN 0-7923-7023-6] Eindhoven, 8-11 July 2001, pp. 139-149
- Dokonal, Wolfgang, Knight, Michael and Dengg, Ernst (2016) *VR or Not VR - No Longer a Question?* Herneoja, Aulikki; Toni Österlund and Piia Markkanen (eds.), Complexity & Simplicity - Proceedings of the 34th eCAADe Conference - Volume 2, University of Oulu, Oulu, Finland, 22-26 August 2016, pp. 573-579
- Dokonal, Wolfgang; Knight, Mike; Dengg, Ernst; *VR or not VR – an eeZee question*, p. 831-837. In: XX Congreso de la Sociedad Iberoamericana de Gráfica Digital [=Blucher Design Proceedings, v.3 n.1]. São Paulo: Blucher, 2016. ISSN 2318-6968, DOI 10.5151/despro-sigradi2016-777

Salim Elwazani

Department of Architecture and Environmental Design, Bowling Green State University,
Bowling Green, Ohio, USA

Attuning to Cultural Significance

Introduction

Overview

The relationship of the documentation function of historic resources and the cultural significance of the resources are inseparable. This study examines the relationship between these two pillars with implications for critical knowledge to the historic preservation field. Critical knowledge is defined as “the most influential information, know-how, or feedback that contributes directly to task outcomes.”¹ The proposition “attuning to cultural significance” anticipates that documentation programs and projects take into consideration the significance established for the resources in question in planning the documentation activity. In this vein, “attuning” helps guide acquiring information sensitive to significance, thus emphasizing the relevancy and economy of documentation.

The study was set to, first, expound on cultural significance in the context of historic preservation and, second, examine the accommodation of cultural significance in documentation programs and projects. The effect of historic resource integrity—a descriptor intimately entwined with significance—on evaluating significance as well as the jurisdictional role in devising and applying significance schemes are discussed. In tandem, the necessity for aligning documentation activities with established cultural significance is illustrated. The study draws on the published works of preservation related agencies including the Secretary of the Interior’s Standards for Historic Preservation, the International Council on Monuments and Sites (ICOMOS), and the American Institute of Architects.

Values and Cultural Significance

By virtue of dealing with information, historic structure documentation is a distinct knowledge domain in historic preservation, including preservation design, a specialty in architecture and allied fields. Research, dimensional configuration, and condition characterization are needed for renovating an existing structure, but when the structure is culturally “significant,” documentation takes on a challenging turn.

¹ Huang, Siyuan; Cummings, Jonathon N. “When critical knowledge is most critical: Centralization in knowledge-intensive teams,” *Small Group Research*, 2011, 42 (6): 669-99.

Cultural significance is a concept entrenched in human values and the perception of collective identity of individuals. Heritage on the whole and preservation in particular are growing popular across countries and jurisdictions because of the values people attach to the vestiges of the past.

Historic preservation policies, plans, and programs all begin with the premise that urban, architectural, engineering, and landscape resources are culturally cherished. Among numerous systems, cultural heritage is described by the Council of Europe as possessing “spiritual, cultural, social and economic values.”² On the more sensible and operational platform, cultural significance is, or is expected to be, satisfied at the scale of projects. The identification and integration of cultural significance engage the responsibilities and capabilities of heritage organizations at local, state, and national levels in the United States, and conceivably continental, and international in a global vein.

The Challenge of Significance

Structuring and applying the concept of cultural significance can be a daunting charge for any jurisdiction. Researchers and officials have to grapple with a wide array of philosophical issues regarding the basis and scope of resources to be considered in the design of a significance scheme. They also have to deal with operational issues of the scheme. The World Heritage List, a compendium of properties of outstanding universal values, is one scheme exemplifying the challenge encountered in contemplating philosophical and operational issues in significance scheme design.³

On the other hand, preservationists and professionals who interface with documentation, design, and implementation of heritage resource projects need to be able to interpret and accommodate significance appropriately in the course of their work. Significance thus impinges on the work of any professional specialist whose work connects in some way with preservation such as restoration, adaptation, or archival documentation related to historic buildings, designed landscapes, and engineering structures. The gamut of specialties includes architecture, landscape architecture, heritage management, and art restoration, among others. One identification approach sorts out these professionals into two groups: a) information providers which include “...all levels of experts in the design and execution of effective heritage recording activity within the conservation process”⁴ and b) information users which include “those who, whatever their profession, trade or discipline of origin...engage in the practice of conservation and are committed to the application of the highest principles and standards of the field in their work”.⁵

² Council of Europe, “The European Charter of the Architectural Heritage,” International Council on Monuments and Sites, accessed April 14, 2017, <http://www.icomos.org/en/charters-and-texts/179-articles-en-francais/ressources/charters-and-standards/170-european-charter-of-the-architectural-heritage>.

³ ICOMOS, *The World Heritage List: What is OUV?* Jokilehto, Jukka (comp.). Berlin: Hendrik Bäßler Verlag. 2008.

⁴ ICOMOS-CIPA-GCI, “5-Year RecordDIM Initiative: Preliminary Plan for 2002-3, <http://www.icomos.org/madrid2002/recordim.pdf>, p.4. (accessed 14.04.2017).

⁵ Ibid.

Documentation and Architecture

Intervening into heritage resources trickles down to the professional design domain. Architects—and counterparts in the allied fields—handle a myriad of activities in connection with existing buildings and architectural ensembles. When the subject building is of historic interest, it turns the architect’s attention to the types, breadth, and quality of the base information needed for the intervention, a prelude sign to attuning to cultural significance of the edifice. The American Institute of Architects is very much in line with this thought: “A property of major significance requires thorough historical research and knowledgeable attention.”⁶ Further, and in the same attuning inclination, the thought helps enlighten the decision making for appropriate treatments: “how a historic property may be treated depends largely on its historical significance and surviving integrity.”⁷

In addition to preparation of statements of significance, the gamut of preservation services related to documentation that an architect performs encompasses preliminary surveys, archival and literature search, condition survey, and fabric analysis.⁸ In this sense, architects play the role of information providers. When architects employ the information to support their own design, they act in an information user capacity as well.

Expounding on Cultural Significance: Does Significance Matter?

Built environment heritage resources are valued as distinct component of communities’ material cultures since they are “physical manifestations of human endeavour, of minds at work (and play), of social, economic, and political processes affecting all of us.”⁹ The concepts of resource significance and integrity underpin the theoretical and applied aspects of heritage in all its forms.

Significance Determination

Significance determination is a condition for proper documentation preceding any resource preservation treatment, such as rehabilitation and restoration. Significance determination for resource types may differ in the criteria and methodologies used in the evaluation. Further, such determinations, involving applicable criteria and methodologies, are hardly the same from one local jurisdiction to the next, let alone from one national heritage program to another. In this vein, the World Heritage List provides heritage evaluation protocols that cater to the “global” mission.¹⁰

To bring to mind the essence of significance and its diverse interpretations, significance criteria schemes adopted by the National Register of Historic Places (NRHP), USA and the Burra Charter, Australia are compared in Table 01.

⁶ American Institute of Architects, “Guide to Historic Preservation,” 2001, p.2.

⁷ Ibid.

⁸ Ibid., p.4.

⁹ Sheumaker, H; Wajda, S. (eds.), “Introduction,” *Material Culture in America: Understanding Everyday Life*. Santa Barbara: ABC-CLIO, 2008, p.xi.

¹⁰ ICOMOS, *The World Heritage List*.

Table 01. Comparison of Significance Criteria: NRHP and Burra Charter

	National Register of Historic Places, USA, Criteria for Evaluation	Burra Charter, Australia, Criteria for Evaluation
1	Major events/trends in history	Historical value
2	Leading Persons	Aesthetic value
3	Eminent creations	Social value
4	New knowledge	Scientific value

Comparative observations regarding the two schemes of criteria can be made:

- NRHP: identifies the criteria in closer affinity to the action (effect) such as events and persons; Burra: identifies the criteria in more holistic terms such as historical values and aesthetic values.
- NRHP: Events/trends and persons categories are entertained in the Burra historical value and social value categories.
- The NRHP Eminent creation category is more inclusive than the Burra artistic value category.
- The NRHP new information category seems to compare with the Burra scientific value category.

Physical and Perceptual Integrity

Integrity gauges how authentic is a resource now in relation to what it was at or during the historic period of significance. The NRHP defines integrity as “the ability of a property to convey its significance.”¹¹ This ability is obtained when the results of the resource authenticity assessment are convincing. The test of authenticity, and concomitantly the test of integrity, applies to several *physical* and *perceptual* attributes of resource characteristics.

Verification of resource authenticity and integrity employs physical or perceptual attributes—the later underscores the need “to examine the layered meanings of space and place.”¹² Physical attributes link to the body of the resource and its setting such as material and location. Perceptual attributes link the resource holistically to conditions during the historic period of reference either through the senses or mentally. The ability of a resource, through the collective effect of its physical and spatial features, to convey a historic sense of a particular period of time expresses the *sensate* attribute of integrity.¹³ The ability of a resource to establish a link between a notable event or figure and a historic resource expresses the association attribute of integrity.¹⁴ In summary, the more physically intact the resource and its setting in relation to its conditions during the historic period of significance, the more it will maintain features of integrity and, in consequence, the quality of significance.

¹¹ National Park Service, *National Register Bulletin 15*, 1995, p.44.

¹² Rothschild, N, “The Colonial Southwest: Pueblo and Spanish Shared and Separate Landscapes” in: Lozny N., (ed.), *Landscape Under Pressure: Theory and Practice of Cultural Heritage, Research and Preservation*. New York: Springer. 2006. p.27.

¹³ National Park Service, *National Register Bulletin 15*, p.45.

¹⁴ Ibid.

Significance and Jurisdiction

Articulating a scheme of significance with a contemplated set of levels is the responsibility of a governmental or some non-governmental entity in the jurisdiction. These schemes generally run at the national, State, and local levels in the United States. Under opportune conditions of global collaboration, commensurate schemes of significance to celebrate inter-continental resources (European Heritage programs) and international resources (UNESCO and ICOMOS programs) have also emerged. The de facto assortment of the basis of significance and classification systems across the globe, while no doubt extensive, represent the uniqueness of values affixed to heritage resources from one jurisdiction to another. In the end, a *significance* scheme is an expression of the direction for which heritage is set to go. In tandem, a *documentation* paradigm is expected to be an expression of harmony with the leading significance scheme.

Accommodating Cultural Significance: Does Documentation Attune to Significance?

Significance is the cornerstone of resource preservation in all of its diverse forms and purposes. So how should this notion play in preservation efforts, including documentation?

Significance Regulates Documentation

The documentation function holds strategic importance and practical merit.¹⁵ It is particularly so when cultural significance is accounted for in the documentation process. Determining significance is a prerequisite for preservation treatments such as preservation, adaptation, and restoration as well as for the purposes of mitigation and archiving. Accommodating significance during the documentation process resonates well with the preservation intent. Significance influences documentation activities in terms of the extent of coverage and reliability of information. In this sense, significance is approached as an entity of multiple, differentiated levels that help shape resource documentation plans and activities. A significance scheme encompassing two levels, say minor and major, would marshal two levels of documentation—expressed through degrees of survey coverage and accuracy. A significance scheme of three levels sets the stage for similarly attuned documentation plan with three levels.

Some heritage management agencies pointedly address significance-documentation relationship in their programs. Parks Canada is an example¹⁶: “heritage values are identified for buildings, cultural landscapes or engineering works through a comprehensive assessment by a multi-disciplinary team formed accordingly. Ultimately, the recording process must ensure that it fully captures these heritage values”.¹⁶

¹⁵ Wu, C; Di, J., “Approach to Standardization System of Architectural Heritage Documentation in China,” in: the Proceedings of the 22nd CIPA Symposium, October 11-15, 2009, Kyoto, Japan.

¹⁶ Leboeuf, J-F; Ouimet, C.; Lumsdon, C.; Zvonar, J.; Utas, G. “National Historic Sites of Canada: A Values-Based Approach to Posterity Heritage Recording,” in: the Proceedings of the 21st CIPA Symposium, October 01-06, 2007, Athens, Greece.

Documentation Standards

The Secretary of the Interior Standards for Architectural and Engineering Documentation directing the work of the architectural, engineering, and landscape documentation programs is a vivid example of documentation program attunement to significance. Standard I articulates the relationship between cultural significance and documentation: “The historic significance of the building, site, structure or object identified in the evaluation process should be conveyed by the drawings, photographs and other materials that comprise documentation.”¹⁷ Standard II, buttresses cultural significance by mandating accuracy and reliability of information “...with limitations clearly stated to permit independent verification of the information.”¹⁸

The Standards spell out four levels of documentation—using measured drawings, photographs, and written data. Level I and Level III only are contrasted below to bring out the effect of different significance levels on the plan of documentation:

- Level I: a) full set of measured drawings depicting existing or historic conditions, b) photographs with large-format negatives of exterior and interior views; photocopies with large-format negatives of select existing drawings or historic views where available, c) history and description.
- Level III: a) sketch plan, b) photographs with large-format negatives of exterior and interior views, c) architectural data form.

International Acceptance

The notion of documentation attuned to significance is accepted internationally, especially by ICOMOS charters and declarations. The 1964 Venice Charter made it clear that “in all works of preservation, restoration or excavation, there should always be precise documentation in the form of analytical and critical reports, illustrated with drawings and photographs.”¹⁹ The implied emphasis on significance and documentation relationship is articulated: “every stage of the work of clearing, consolidation, rearrangement and integration, as well as technical and formal features identified during the course of the work, should be included.”²⁰ However, significance and documentation relationship is more explicitly articulated in the 1996 ICOMOS Principles for the Recording of Monuments, Groups of Buildings and Sites which states that “recording is one of the principal ways available to give meaning, understanding, definition and recognition of the values of the cultural heritage.”²¹ The Principles set documentation as priority in great many cases and demand informed selection of recording scope, level, and methods.²²

¹⁷ National Park Service, Secretary of the Interior Standards for Architectural and Engineering Documentation, 1995, p.5.

¹⁸ Ibid.

¹⁹ ICOMOS, “International Charter for the Conservation and Restoration of Monuments and Sites (Venice Charter 1964)”. https://www.icomos.org/charters/venice_e.pdf (accessed 16.04.2017), p.4.

²⁰ Ibid.

²¹ ICOMOS, “Principles for the Recording of Monuments, Groups of Buildings and Sites.” <https://www.icomos.org/charters/archives-e.pdf> (accessed 16.04.2017), p.49.

²² Ibid., p.50.

Concluding Remarks

This paper set out to examine the concept of cultural significance and to explore its place and integration in heritage preservation efforts, particularly as related to the documentation function. Engrossed in the philosophical ideals regarding heritage in general and historic resources in particular, the theoretical construct of significance is liable to encounter wide interpretations. World-wide acceptance for categories of resources is growing, but the weighing attributes used by different jurisdictions to judge the worth of the resources are far from unanimous. Significance-attentive documentation precedents and methodologies are disseminated by local, national, and international bodies. These provide guidance for learning, designing, and executing documentation schemes on the policy and standards level and on the project and implementation level.

While flat unanimity is not possible or even desired for the sake of preserving heritage uniqueness of localities and nations, the challenge remains present in synthesizing heritage assessment attributes based on sound theoretical construct of heritage and heritage significance. The role of documentation in accordance with, and in perpetuating, cultural significance springs from its centrality in the preservation process. Proper documentation is premised on adequate understanding of cultural significance and, by extension, documentation is grounded in the planning for carrying out research, recoding, and data presentation for individual projects.

The role of documentation as a catalyst of harmony between cultural significance and preservation action anticipates judicious design for information that would explicate the significance of the documentation subject. The “critical” information arising from cumulative documentation events, together with the experiential learning and adjustment that come with it, adds to the body of critical knowledge that can only buttress the effectiveness of documentation programs and practices. Architects and professionals in the design fields, in their capacities as information providers and information users, have the opportunity to capitalize on the notion of “attuning to cultural significance” with all the ramifications that the assumed critical knowledge approach can bring to their professional vitality.

Bibliography

- American Institute of Architects. “Guide to Historic Preservation”. 2001.
- Council of Europe. “The European Charter of the Architectural Heritage”. International Council on Monuments and Sites, accessed April 14, 2017, <http://www.icomos.org/en/charters-and-texts/179-articles-en-francais/ressources/charters-and-standards/170-european-charter-of-the-architectural-heritage>.
- Huang, Siyan; Cummings, Jonathon N. “When critical knowledge is most critical: Centralization in knowledge-intensive teams”. *Small Group Research*, 2011, 42 (6): 669-699.
- ICOMOS-CIPA-GCI. “5-Year RecordDIM Initiative: Preliminary Plan for 2002-3, <http://www.icomos.org/madrid2002/recordim.pdf>, P.4. (accessed

- 14.04.2017).
- ICOMOS. "International Charter for the Conservation and Restoration of Monuments and Sites (Venice Charter 1964)". https://www.icomos.org/charters/venice_e.pdf (accessed 16.04.2017).
- ICOMOS. "Principles for the Recording of Monuments, Groups of Buildings and Sites." <https://www.icomos.org/charters/archives-e.pdf> (accessed 16.04.2017).
- ICOMOS. *The World Heritage List: What is OUV?* Jokilehto, Jukka (comp.). Berlin: Hendrik Bäblier Verlag. 2008.
- Leboeuf, J-F; Ouimet, C.; Lumsdon, C.; Zvonar, J.; Utas, G. "National Historic Sites of Canada: A Values-Based Approach to Posterity Heritage Recording," in: the Proceedings of the 21st CIPA Symposium, October 01-06, 2007, Athens, Greece.
- National Park Service. National Register Bulletin 15. 1995.
- National Park Service. Secretary of the Interior Standards for Architectural and Engineering Documentation. 1995.
- Rothschild, N. "The Colonial Southwest: Pueblo and Spanish Shared and Separate Landscapes" in: Lozny N., (ed.). *Landscape Under Pressure: Theory and Practice of Cultural Heritage, Research and Preservation*. New York: Springer. 2006.
- Sheumaker, H; Wajda, S. (eds.) "Introduction". *Material Culture in America: Understanding Everyday Life*. Santa Barbara: ABC-CLIO. 2008.
- Sun, Peter. Five critical knowledge management organizational themes, *Journal of Knowledge Management*, 2010, 14 (4): 507-23, p.509.
- Wu, C. and Di, J. "Approach to Standardization System of Architectural Heritage Documentation in China," in: *the Proceedings of the 22nd CIPA Symposium, October 11-15, 2009, Kyoto, Japan*.

Danilo Di Mascio ^a, Ruth Dalton ^b

^{a, b} Department of Architecture and Built Environment, Northumbria University, Newcastle upon Tyne, United Kingdom, ^a Open Lab, Newcastle University, Newcastle upon Tyne, United Kingdom.

Narrative facades of Grainger Street: Design and manufacturing of a physical model for participatory design

Introduction

Participatory design - and related methods and tools - is receiving more and more attention in recent years due to the necessity of creating public places and cities that are closer to citizens' desires and needs¹. Participatory design can give citizens the opportunity to actively contribute in the design process with their ideas and reflections based on their various daily life experience. Participatory activities, addressed at the production and shaping of the urban life, are also recognized as relevant for an active ageing and the urban environment is the first of the eight domains of an Age-Friendly City². However, there are several issues that can limit people's engagement in these activities. One of the most relevant is the difficult communication between experts and lay people because their different background and ways of reasoning on the urban environment. Moreover, usually lay people miss an awareness of the architectural features of the urban environment that is beneficial in a participatory design project. Besides this lack of awareness there is also another issue, namely lay people's difficulties in understanding architectural drawings and models that constitute the essential visual language of architecture and urban design. Architects and urban designers can reduce these knowledge gaps between experts and lay people, by designing tools that can be used as facilitator in the participatory design process. In Ahn and Park 2007³ for example, the drawings for citizens presented a more realistic and detailed graphical representation in order to allow lay people to better understand the place and its surroundings. Although there is research around methodologies and

¹ Sanoff, Henry. *Community participation methods in design and planning*. Canada: John Wiley & Sons, Inc. 2000.

² [http://www.cpa.org.uk/cpa-lga-evidence/Manchester-Age_Friendly_Neighbourhoods/Handler\(2014\)-An_Alternative_Age-Friendly_Handbook-Large_print_version.pdf](http://www.cpa.org.uk/cpa-lga-evidence/Manchester-Age_Friendly_Neighbourhoods/Handler(2014)-An_Alternative_Age-Friendly_Handbook-Large_print_version.pdf) (10.11.2015).

³ Ahn, Hyun-Chan; Park, So-Hyun. "Design Tools and Three Steps in Participatory Design Processes" in: Pro-ceedings of the 6th Pacific Rim Community Design Network and 1st Xiamen-Quanzhou-Zhangzhou-Longyan Cities Alliance Designers Conference. Quanzhou, Fujian, China, June. 2007.

tools that can facilitate lay people's engagement in participatory design, the use of drawings and models are still under explored.

This paper presents the design and manufacturing of a large-scale physical model of a historical street for participatory design purposes. The physical model, grounded in architectural representation and developed using state-of-the-art digital technologies, presents a form of interaction that usually lacks in similar artefacts, and - as far as we can tell - it may be the first of this kind. In fact, the model allows people to write, draw and share their memories and stories directly on the facades; hence the model connects architectural representation and narrative, and stimulates collective conversations.

Common issues in participatory design activities

In (Di Mascio and Dalton 2017)⁴, the following five areas and related issues that characterize Participatory Design activities have been identified and described: Communication, Content, Tools, Role and Phase. The issues linked with these 5 categories are the result of the, usually, challenging interaction between experts and lay people. One of the main issues is related to the communication between both of them, because they have different knowledge and way of looking at the urban environment. Lee⁵ borrowed the concepts introduced by the French philosopher Henri Lefebvre⁶ of "abstract space" – where architects and designers develop their design proposals – and "concrete space" – where people live and experience their everyday life. She suggests that only an overlapping of these two spaces can generate what she called the "realm of collaboration"⁷. However, a constructive communication around an urban design project requires first a shared language and second a shared basic knowledge about the place of the project. Attending a consultation process of a Street in Newcastle upon Tyne⁸ - as part of a research workshop - confirmed once again citizens difficulty in reading technical drawings. This can strongly limit the extent to which they can contribute in a participatory design activity because drawings and models are the visual language used by architects and urban designers to analyze and design buildings and places. Usually citizens don't have sufficient awareness and knowledge of streets and other public spaces that they use every day because when they move through those spaces they simply see the environment, they don't look at the environment. To see is a spontaneous and passive action that doesn't imply attention or built awareness. On the contrary, to look implies intentionality, namely the desire to recognize and understand

⁴ Di Mascio, Danilo; Dalton, Ruth. "Using serious games to establish a dialogue between designers and citizens in participatory design. The architectural portal of people's narratives" in: Ma, Minhua & Oikonomou, Andreas (eds.). *Serious Games and Edutainment Applications 2*. UK: Springer International Publishing AG. 2017. p. 433-454.

⁵ Lee, Yanki. *Design Participation Tactics: Redefining User Participation in Design*. In the Proceedings of the Design Research Society International Conference: Wonderground. Lisbon, Portugal, 1-4 November 2006. p. 15.

⁶ Lefebvre, Henri. *The production of space*. Oxford, UK: Blackwell Publishers. 1991.

⁷ Lee, Yanki. op. cit.

⁸ <https://www.newcastle.gov.uk/parking-roads-and-transport/re-newcastle-transport-improvements/john-dobson-street-improvements> (accessed 28.04.2017)

the observed elements; hence, it is an active action with an aim. There is a reason why one of the first fundamental steps of any architectural and urban design project is the site analysis. Even if architects and urban designers are professionals, they need methods, tools and time to understand a site and its main features. As mentioned before, another difficulty is related to the tools used by experts, namely drawings and models with whom lay people are in general not familiar.

The role of drawings and models in participatory design

For centuries, drawings and models have always constituted the visual language of architectural representation. The wide range of representational techniques and model makings support architects and urban designers in the development of ideas and design solutions during every single stage of a project until its final communication phase⁹. Drawings and models have been used to envision, design and build very different architecture, public spaces and cities, hence becoming familiar with basic elements of this rich visual vocabulary is essential and unavoidable if citizens want to actively participate in those activities in effective ways. There are many different drawings and kinds of models used by architects and urban designers such as two-dimensional drawings (plan views, elevations) and massing models and each of them can be used for specific purposes¹⁰.

Drawings and models have already demonstrated their usefulness in participatory design activities, and their importance is fully recognized¹¹. At the same time, it is relevant to highlight that their use in participatory design activities is different compared to the one in architecture and urban design mainly because the audience is different, hence there is another variable to consider. Firstly, drawings and models in a participatory design environment are not limited to the development and presentation of a design idea; they should also foster and facilitate citizens' inclusion in participatory activities. For this reason, for example, in (Ahn and Park 2007)¹² the authors describe how they had to add more details to the drawings– such as human figures, colors, textures and materials – in order to make them easier to understand by lay people; the aim was to improve citizens' engagement in the design activities. It is evident that this first aspect is linked with visualization/representation, and hence communication. Secondly, as a result of different backgrounds and ways of thinking and designing, experts and lay people cannot use drawings and models in the same ways, especially in the early stage of design activities.

Hence, it is possible to summarize that drawings and models made for participatory design activities should always be both understandable and engaging, hence they should assume a role of facilitator.

⁹ Zell, Mo. *The Architectural Drawing Course. Understanding the principles and master the practices*. London, UK: Thames & Hudson. 2008.

¹⁰ Farrelly, Lorraine. *Drawing for urban design*. London, UK: Laurence King Publishing Ltd. 2011.

¹¹ Wates, Nick. *The Community Planning Handbook. How people can shape their cities, towns & villages in any part of the world*. Abingdon, Oxon, UK: Earthscan. 2000.

¹² Ahn, Hyun-Chan; Park, So-Hyun. op. cit.

Case Study: Narrative Facades of Grainger Street

The main aim of this research is to elaborate and propose a way of improving people's awareness of both the urban environment and the visual language of architectural representation by designing, manufacturing and use of a physical model made by narrative facades. The physical model represents Grainger Street, one of the main historical streets in Newcastle; the street connects Central Station to Monument and it is characterized by remarkable pieces of Georgian and Victorian Architecture.

This project composes part of a case study titled Narrative Urban Environments that is part of a multidisciplinary research project titled MyPlace: Mobility and Place for the Age Friendly City Environment. The project investigates how Newcastle upon Tyne (UK) can become an Age Friendly City through research, planning and design activities that consider or involve citizens in different ways. The World Health Organization (WHO) identifies eight domains of an Age Friendly City¹³. The Narrative Urban Environments case study connects with the Age Friendly City initiative in three key areas, namely: participation, urban life, and the built environment (outdoor space and buildings).

In this project, the role of the architect/urban designer is the one of a facilitator, namely the one of a professional that both participate in an active way at workshops (and similar events) and design methodologies and objects that are used as facilitator themselves.

Main objective: Improving awareness and communication

The main objective of the research is to design and manufacture a physical model that can be used as facilitator for the following purposes:

- To improve lay people's awareness and comprehension of selected aspects of the urban environment;
- To facilitate lay people's awareness and comprehension of the architectural visual language;
- To challenge people's memory and promote the idea to look at the urban environment and not simply to see it;
- To trigger citizens' curiosity and hence stimulate their interest on the street.

Methodology: From conceptual design to manufacturing

The following points summarize the design and manufacturing process of the narrative façades:

1. ***Conceptual design phase:*** the main concept that addressed the design of the physical model was the idea to allow people to interact with it in an innovative and engaging way, namely drawing and writing their thoughts and narratives linked with the street directly on the facades of the buildings. Very often, workshops participants or visitors of an exhibition are allowed to a limited set of actions towards physical models: they can be involved in the making of the model, using for example cardboard, or in moving and arranging pieces that can represent volumes of entire buildings or parts of a single building. The design of the model

¹³ Op. cit. For the link please see footnote 2.

(Fig. 01) was developed taking into consideration and merging several concepts related to the following topics: visual architectural language, visual and written narrative, interaction, drawing and sketching, playfulness, communication and flexibility. The model allows people to share their narratives and in doing so, it fosters conversations between lay people themselves (besides conversations between laypeople and experts). In this case, it is possible to talk about the model as an intermediate object.

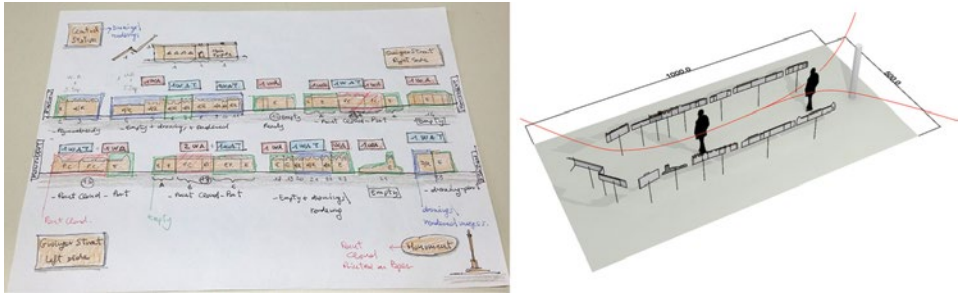

Fig. 01. Drawing (left) and digital 3d model (right) used in the design process.

Source: personal archive of the author.

2. **Selection of the materials:** the choice of the materials was addressed by three main needs. Firstly, the surfaces had to be solid enough to allow people to write and draw in a comfortable way and to avoid any bending and dangerous breaking. Secondly, all the facades had to allow visitors to write and draw on them with washable markers in a way similar to whiteboards, and hence to be cleanable at the end of each day (after the facades were documented by photographs) to allow other visitors to use the facades the day after. Thirdly, some of the facades had to be transparent enough to allow people to recognize the images of the point clouds put behind them and at the same time to allow texts and drawings to be noticeable enough from the background. To achieve those three objectives, two different kinds of acrylic were selected - white and with 70% light transmission - and plywood.
3. **Creation of the digital facades:** the available time and design choices addressed the design, manufacturing and level of detail of the model. For each facade, two profiles (silhouettes) were created in a CAD software (Rhino), using the point cloud data as a base to trace over the contours. A first profile – in plywood - includes the line of the rooftop, while a second silhouette – in acrylic - represents the facade itself. Also the architectural representation of the elevations of the facades were drawn in vector format using both the point cloud data and 3d models from the 3d digital reconstruction of the street (still in progress). All the files have been then exported in AI format and transferred to the Computer Numerical Control (CNC) Machine.
4. **Laser cutting of the boards:** in total, 75 boards were laser cut.
5. **Representation of the facades:** the facades of the model were treated in four different ways: the first group presented complete architectural elevations; a

second group of facades displays partially completed drawings; a third group showed printed images of the point clouds superimposed to the plywood and in turn covered by the semi-transparent acrylic surfaces; the fourth type of facades were completely white/empty surfaces. Different representations foster different ways of interacting with the facades and help to create a more varied and interesting experience. In a similar way as in “doodle” books for kids (and even adults¹⁴), where they are asked to complete drawings or colour them, each representation of the facades encourage people to draw or write in a different way. For example, in the partially completed facades, there are lines, shapes and details that suggest architectural elements, users of the model are encouraged to complete the elevations from memory. The elevations were drawn using the standard architectural representation. To achieve an aesthetic effect similar to a technical drawing on white paper and provide people the feeling of drawing and colouring like on a colouring book, it was decided to engrave the lines directly on the acrylic facades. However, this choice presented a challenge, namely how to create crisp black lines on a white acrylic surface. To achieve the desired effect, several techniques were explored. At the end, the 2d line drawings were engraved and then painted using acrylic artistic ink and two kinds of brushes. Then the facades were cleaned using cleaning paper soaked with an API solution. This process creates permanent crisp black lines that remain also when the facades are being wiped (Fig. 2).

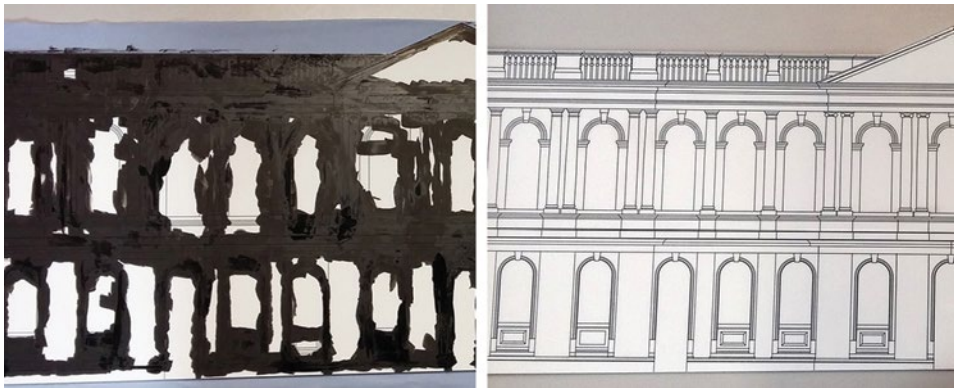

Fig. 02. (Left) Painted façade (before being cleaned); (Right) cleaned façade.

Source: personal archive of the author.

6. **Assembling of the facades:** all the facades were assembled on battens, using bolts. Then, the battens were put together on easels.

¹⁴ In this regard, an example is represented by: Bowkett, Steve. *Archi-Doodle: An Architect's Activity Book*. Laurence King Publishing Ltd. 2013.

Reflections and evaluations on a preliminary exhibition

After all the above points, the model was set up in the city library as part of an exhibition (in the City Library in Newcastle upon Tyne, UK) titled Mapping the City¹⁵, organized as part of a bigger event called Juice Festival¹⁶. This big event was mainly addresses to families and young people under-25s, for this reason it was decided to allow people a higher degree of freedom in interacting with the physical model (Fig. 3). The only instruction that were provided to the visitors of the exhibition was an invitation to write and draw on the model of Grainger Street in order to share their memories and stories about Newcastle. With this freedom, it was possible to observe how people interpreted their ways of interacting with the model. At the end of each day, each façade/group of facades were photographed and afterwards wiped clean. In this way, it was possible to verify if specific facades were used on consecutive days. The fact that at the end of each day all the facades presented some doodles, drawings or texts demonstrates that the model was successfully received by the visitors. A first evaluation of people's interaction with the model was done by observations. The doodles/drawings/texts were organized into 3 main categories (some façade/group of facades was included in more than one category because they presented different kind of contents): (a) context-specific content; (b) general architectural/urban content; (c) unrelated content.

Unsurprisingly, taking into account the kind of event and the freedom provided to the visitors, the unrelated content occurred more frequently than the other two types. Moreover, the context-specific content occurred least frequently. Considering the target audience of the exhibition, it is likely that most of the people that used the model were children/teenagers, and this may also explain the high number of unrelated doodles/drawings and texts.



Fig. 03. (Left) The physical model in the City Library; (Right) teenager drawing on the model.

Source: personal archive of the author.

¹⁵ The exhibition was organized by other academics from Northumbria University namely: Sebastian Messer, Mike Jeffries and Jon Swords (www.mappingthecity.net).

¹⁶ <http://www.newcastlegateshead.com/juice-festival> (accessed 25.04.2017).

Conclusions and future developments

In this paper, the design and manufacturing of a physical model useful to improve lay people's awareness about the urban environment and their comprehension and use of drawings has been presented. Citizens can improve those two points - essential to achieve a good and constructive communication between lay people and experts in a participatory design environment - while sharing their memories and stories about a place on the Narrative Facades using drawings, doodles and texts. The model challenges their memory and triggers their interest in a playful way by presenting facades with 4 different kinds of representations (complete elevations, partial elevations, point clouds images, all white). Future developments include: further uses of the physical model with different age groups and in different venues; other investigation of the concept of playfulness; difference between an allocentric and an egocentric experience.

Acknowledgments

The authors would like to thank Professor Peter Wright and Professor Patrick Olivier, Principal Investigator and Co-Investigator of the MyPlace project, respectively; the research was funded by EPSRC (Design for Wellbeing)-EP/K037366/1.

Four-Dimensional Nature of Urban Structures – Reflections upon Company Towns

Introduction

This study is based on results of an extensive research conducted during the years 2006-2010, which resulted in publication of a book awarded European Union Prize for Cultural Heritage in 2013¹. The volume provided a comparative analysis of company towns in European textile industry. The research was conducted in architectural history domain, there have been, however, observations on condition of such sites at the early 21st century.

The most important economical transformations that occurred in Europe during the second half of 20th century, contributed to the emergence of extensive post-industrial areas in need for regeneration. The decline of traditional industries has caused the separation of factories and associated workers' housing. As a result, regeneration processes within post-industrial and residential areas take place separately. This leads to the functional and spatial disintegration and raises a number of problems and conflicts.

The latter issue stimulates reflections upon the perception of post-industrial complexes and their influence on the image of places and - in some cases - of whole towns. The author's practice in the heritage conservation domain provided further reflection on the role of urban regeneration in reinterpretation of historical sites. What is more, there is, surprisingly, very little literature which deals with the impact of heritage investment on users' sense of place². This should be, however, seen in particular social, cultural, political context being subject to constant change over passage of time.

¹ Walczak, B.M. *Zespoły fabryczno-mieszkalne w europejskim przemyśle włókienniczym w latach 1771-1914. Geneza-Rozwój-Typologia*, Łódź: Politechnika Łódzka, 2010.

² cf. Reeve, A. and Shipley, R. "The impact of heritage investment on public attitudes to place: evidence from the Townscape Heritage Initiative (THI)", *Urban, Planning and Transport Research: An Open Access Journal*, 2014 Vol. 2, No. 1, p. 289-311.

Theoretical background

The concepts of space, time and meaning may affect unconsciously one's attitude towards a particular urban structure. They may become subject of a research³. They may also become a tool for an architect and urban planner⁴. Their perception was, however, evolving - depending on researcher's background, political context and many other circumstances. For example, Henri Lefebvre - a French philosopher and sociologist - proposed to analyse space through a three-part dialectic between everyday practices and perceptions (*le perçu*), representations or theories of space (*le conçu*) and the spatial imaginary of the time (*le vécu*)⁵. Interpretations of Lefebvre's theory of spatial production emphasize that each of the three dimensions cannot be analytically separated, but must be treated holistically. Spatial practice, spatial planning and spatial imagination all come together into a single moment of social space.

Lefebvre's approach to the city influenced by Hegel and Nietzsche was criticised by Manuel Castells in his book *La question Urbaine*⁶. He also developed his own concept - "space of flows" - which is a high-level cultural abstraction of space and time, and their dynamic interactions with digital age society.

Traditionally, the concept of space is considered a passive entity, while time is considered a separate and active entity. Space should not be disconnected from time, because space is a dynamic entity related to time. What is more, space is the physical support of the way people live in time. Therefore, some researchers considered towns as four-dimensional structures⁷. In this respect, architecture - and built heritage in particular - may be understood in terms of storytelling⁸. The dialectic between a changing materiality and changing meanings constitute a reinterpretation process.

Reinterpreting heritage

The case of post-industrial buildings is in this respect of particular interest due to the dramatic changes that occurred over a short span of time. This may be also illustrated with the following example:

A traveller at the beginning of the 21st century looks out of the window of a train. He or she sees a large, neat six-storey brick building with symmetrical rows of windows that are newly painted and have corresponding shades. The building stretches along the track close to a railway station and the centre of a middle-sized Western European town. How can this view be spontaneously interpreted?

³ eg. Neuhaus, F. (ed.). *Studies in Temporal Urbanism*, Dordrecht: Springer, 2010.

⁴ Wejchert, K. *Elementy kompozycji urbanistycznej*, Warsaw: Arkady, 1974.

⁵ cf. Lefebvre, H. *Le Droit à la ville*, Paris: Anthropos, 1968; Lefebvre, H. *La révolution urbaine* Paris: Gallimard, 1970.

⁶ Castells, M. *La question Urbaine*, Paris: François Maspero, 1972.

⁷ eg. Kucza-Kuczyński, K. *Czwarty wymiar architektury miasta*, Warsaw: Arkady, 1982.

⁸ cf. Ampatzidou, C. and Molenda, A. "Building Stories – the architectural design process as narrative", International Digital Storytelling Conference *Digital Storytelling in Times of Crisis*, Athens, 2014.

Perhaps the traveller's first thought is "Oh, they have a textile mill in this town" or perhaps it is rather "Oh, another regional college or business park." (...) A chosen interpretation will not only assert the building as being primarily a former mill or a new school, but will also characterise it in terms of meaning and value⁹.

In the light of above citation, the sense and importance of an old industrial building has changed significantly due to its re-use. But what is even more important, the meaning may also influence the materiality of a place – its decay, its demolition or renewal. It is also of crucial importance for successful heritage preservation, since - according to well-known phrase by Freeman Tilden - interpretation leads to understanding, understanding to appreciation, and appreciation to protection¹⁰.

In the following section these issues will be discussed in context of company towns, their origins, primary meanings, and subsequent reinterpretation processes.

Company towns - their perception and meaning

The workers' housing emerged as a result of separation of places of work and living during the industrial revolution. In spatial terms, the distance between these two locations was of crucial importance¹¹. Thus, it was the necessity which spurred industrialists to establish settlements next to their factories.

In the second half of the 19th century such residential complexes evolved into well-planned entities. Their spatial order in this context can be seen as a counterweight to the chaotically growing cities. Their location and spatial arrangement was an attempt to reconcile tradition and modernity. On the one hand there was visible return to traditional spatial relationships known from rural farms, with a factory replacing a manor house. What is more, geographical proximity was stimulating strong social networks that in consequence determined important outcomes in social life. The latter issue will become of great importance in the era of industrial decline.

Conversely, open plan, zoning and linear systems were promising projects of Arturo Soria y Mata and Tony Garnier. Especially the latter met the needs of the industrial era, while bringing the seeds of modern urban design, developed after the World War I by the leaders of the modern movement, and in particular by Le Corbusier.

The same space may be, however, seen as materialization of power relations. This notion allows at least twofold interpretation, as research by Thomas Markus has revealed¹². First, power is considered as a energy required to run machinery in a factory. An introduction of steam engine opened new possibilities for the industrial development. The novelty was the changed rhythm of life, marked by the shift work

⁹ Storm, A. *Hope and Rust. Reinterpreting the industrial place in the late 20th century*, Stockholm: Royal Institute of Technology, 2008, p. 9.

¹⁰ Tilden, F. *Interpreting our Heritage: Principles and Practices for Visitor Services in Parks, Museums, and Historic Places*. Chapel Hill: University of North Carolina Press, 1957. p. 38.

¹¹ For the purpose of this study other spatial relations (e.g. physical distance between resources and competitors, physical distance between co-operating organizations) important from the business management point of view, has been omitted - see: Taylor, S. and Spicer, A. "Time for space: A narrative review of research on organizational spaces", *International Journal of Management Reviews*, no.9. 2007. p. 325-346.

¹² Markus, T.A. *Buildings and Power*, London-New York: Routledge, 1993.

system, measured by clocks placed in prominent places - usually on the factory towers. Workers become cogwheels of a great machine. As a consequence, the power had far-reaching impact on all aspects of life of the whole industrial society:

A new ethic was preached in which the cardinal sin was not cruelty or vice, but idleness. Even the Sunday schools warned children that “*Satan* finds some Mischief still | For idle Hands to do”¹³.

Secondly, the power may be interpreted in terms of social relations. In this perspective, factories are considered to be spaces where industrial workers were concentrated to ensure better surveillance and control by entrepreneurs. This desire to control the workforce was, without doubt, given its most potent expression in company towns, which in the second half of the 19th century were part of a pan-European phenomenon involving paternalistic concepts of business management as a method of prevention from the socialist movement. The houses were only part of the system, creating decent working and living conditions for the workers, but consequently led to their dependence on the company. Thus, the settlement became an exemplification of the total spatial integration of production, labour, society and - in many cases - of religion.

Regularity and arrangement of buildings reflected the rigor and discipline imposed on the residents. Life in many company towns was defined by the strict rules laid down by the manufacturers. The industrialists became the masters of the land, factories, and the fate of the inhabitants. Everything workers and their families might need was provided, or at least controlled by the manufacturer. It included also the recreation time.

In this respect Cromford in Derbyshire is a good example. The owners' manor house was built on a gentle slope in a bend of the river, from which it was possible to look at two factories and associated workers' housing estate. In this way, location of individual components of the assembly reflected dominant position of industrialist constantly controlling subordinated people. The most coherent spatial effect was, however, achieved in Crespi d'Adda in Italy. There was adopted a biaxial urban composition. One of the two main composition axes was closed by the carefully designed factory. The other axis formed the main road leading along the production buildings to the local cemetery. In this way the axis achieved a symbolic importance of workers' “way of life”.

In the respect of the latter observation it becomes clear that the space may be also interpreted in terms of life experience. For example, worker experience as a permanent resident of a company town will be radically different from that of a visitor¹⁴. What is more, perception depends on personal background (education, previous experiences, etc.). This may be illustrated with workers of the Scheibler factory in Łódź, who were predominantly of rural origins and felt lost in the big industrial city and confused by the new circumstances. These uneducated, illiterate

¹³ Bronowski, J. *The Ascent of Man*, London: BBC Books Random House, 2011, p. 211.

¹⁴ cf. Walczak, B.M. “The Image of Industrial Heritage: the Case of Łódź” in: Kepczyńska-Walczak, A. (ed.) *Envisioning Architecture: Image, perception and Communication of Heritage*, Łódź: Politechnika Łódzka, 2015, p.17-26.

people perceived the industrialist's omnipotence as supernatural¹⁵. Concurrently, such industrial sites visited by the representatives of the social elite appeared as fascinating but repulsive places. Written accounts of the visitors' experiences contributed to the negative perception of the industry and the whole city. Such opinion prevailed until the late 20th century when industrial activities started to decline.

Demise of industrial landscape

The life of a large group of people in a relatively small area causes both positive and negative social phenomena. The former include the sense of belonging to the community emerging in almost every company town. Settlements, usually located on the outskirts of urban areas, became habitats connecting elements of civilization and nature, creating relatively favourable conditions of life. They developed as a microcosm, which identified the people, for generations associated with the factory (fig. 01.). Spatial order and social harmony were maintained in a number of European settlements until the 1970s, when the global crisis heavily affected traditional industries in Europe. The factory decline meant not only the loss of economic livelihoods for people dwelling the settlement - it was the end of the local community, and the disintegration of long-existing ties between people: The industrial sites “can no longer convincingly epitomize the promise of endless economic growth”¹⁶ and what is more they “materialize the backwardness and resistance against necessary modernization attempts”¹⁷.



Fig. 01. The workers housing in Eisenheim, the Ruhr region in Germany is a good example of preserved unique atmosphere. Source: author

¹⁵ Łukowska, M.A., *Fabrykant łódzki we wspomnieniach robotników*, Łódź 2007.

¹⁶ Bangstad, T.R. *Defamiliarization, Conflict and Authenticity: Industrial Heritage and the Problem of Representation*, Trondheim: Norwegian University of Science and Technology, 2014, p. 67.

¹⁷ Schwarz, A. “Industriekultur, Image und Identität im Ruhrgebiet oder: Die Umstrittene Frage nach dem Strukturwandel in den Köpfen” in: Schwarz, A. (ed.) *Industriekultur, Image, Identität: Die Zeche Zollverein und der Wandel in den Köpfen*, Essen: Klartext verlag, 2008, pp. 17-68.

The situation has been gradually changing over last decades. With the passage of time, bad memories went away in oblivion. The next generations without being fully aware of factory work realm, have been building their vision of the past - since as Zukin pointed out: "only people who do not know the steam and sweat of a real factory can find industrial space romantic or interesting"¹⁸. Therefore, there were not the former workers but newcomers to the place, who was involved in the reinterpretation and reuse processes.

However, gentrification can be particularly harmful for the company towns, as it results usually in the breakdown of the integrity of the complex. The consequence is that transformation processes occur separately in factories and workers housing. The industrial buildings are subject to various adaptation measures, often very interesting in terms of adopted functional, spatial and architectural solutions. Concurrently, former workers' houses are usually owned by people, individually adapting them to their needs. The result is a far-reaching restructuring, blurring the original building features and deepening the disintegration of the whole complex. Settlements are also areas in which all the social problems resulting from the industrial decline concentrate. Only some neighbourhoods, thanks to their location and spatial advantages are not affected by the progressive degradation.

There is an urgent need to re-establish integrity of company towns. The appropriate role of heritage is to tell the true story of the past not just to become a commodity in contemporary business and leisure activities. This may be achieved through a sensitive architectural design deploying storytelling concept. A recent example of regeneration of a factory building in Łódź indicates that there is potential for exploring the multilayered past as driving force of a good quality architecture (fig. 02.).

Conclusions

The company towns testify not only a significant period of economic history, but also the development of social thought, being one of the most important steps leading to the creation of the pioneering concept in architecture and city planning at the turn of the 19th and 20th centuries.

Given the undeniable historical and spatial values of the company towns, they should be included in the revitalization processes. Due to the complexity of the regeneration problems, which involves urban, architectural and social preservation issues, it seems that it is necessary to develop special methods for managing and coordinating projects carried out within such complexes, in order to preserve their integrity. However, the results are not always in line with the expectations. The co-existence of old and new inhabitants/users as well as old and new architectural forms imposes new meanings of historical places. As a result - time and space might be used again for shaping such places and changing their perception.

¹⁸ Zukin, S. *Loft living: Culture and capital in urban change*, New Brunswick: Rutgers University Press, 1989. p. 59.

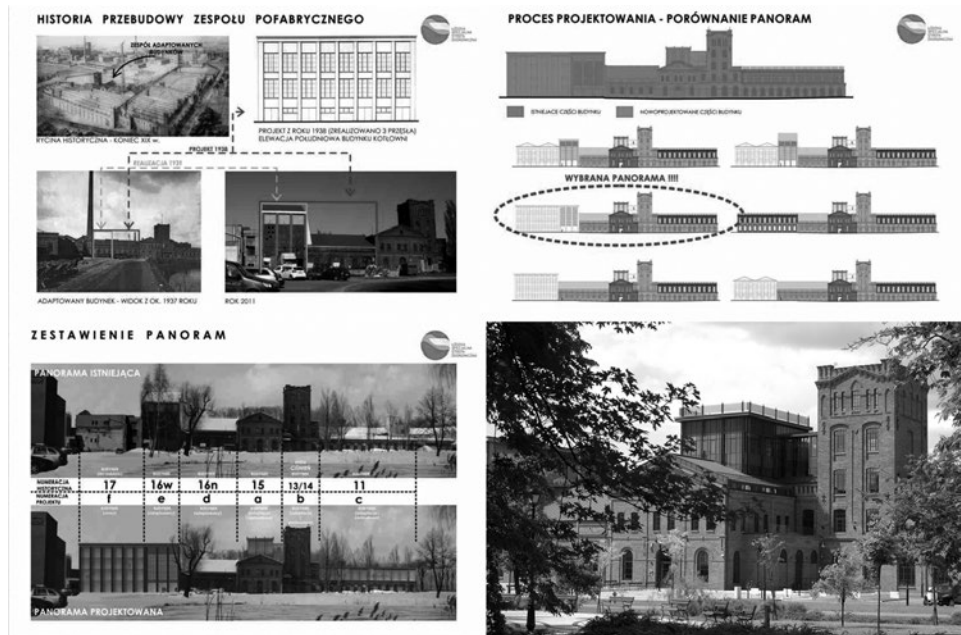

Fig. 02. Conversion of a former Grohman factory into the Special Economy Zone managing office and conference centre. The assembled images and drawings show how architects tried to use complicated architectural history of the complex into a contemporary architectural solution

Source: author; explanation boards: courtesy of AGG – Architekci Grupa Grabowski.

Bibliography

- Ampatzidou, C. and Molenda, A. “Building Stories – the architectural design process as narrative”. International Digital Storytelling Conference *Digital Storytelling in Times of Crisis*. Athens. 2014.
- Bangstad, T.R. *Defamiliarization, Conflict and Authenticity: Industrial Heritage and the Problem of Representation*. Trondheim: Norwegian University of Science and Technology. 2014.
- Bronowski, J. *The Ascent of Man*, London: BBC Books Random House, 2011.
- Castells, M. *La question Urbaine*. Paris: François Maspero. 1972.
- Kuczka-Kuczyński, K. *Czwarty wymiar architektury miasta*. Warsaw: Arkady. 1982.
- Lefebvre, H. *Le Droit à la ville*. Paris: Anthropos. 1968.
- Lefebvre, H. *La révolution urbaine*. Paris: Gallimard. 1970.
- Łukowska, M.A., *Fabrykant łódzki we wspomnieniach robotników*, Łódź 2007.
- Markus, T.A. *Buildings and Power*, London-New York: Routledge, 1993.
- Neuhaus, F. (ed.). *Studies in Temporal Urbanism*. Dordrecht: Springer. 2010.
- Reeve, A. and Shipley, R. “The impact of heritage investment on public attitudes to place: evidence from the Townscape Heritage Initiative (THI)”. *Urban, Planning and Transport Research: An Open Access Journal*. Vol. 2. No. 1.

2014. p. 289-311.
- Schwarz, A. "Industriekultur, Image und Identität im Ruhrgebiet oder: Die Umstrittene Frage nach dem Strukturwandel in den Köpfen" in: Schwarz, A. (ed.) *Industriekultur, Image, Identität: Die Zeche Zollverein und der Wandel in den Köpfen*. Essen: Klartext verlag. 2008. pp. 17-68.
- Storm, A. *Hope and Rust. Reinterpreting the industrial place in the late 20th century*. Stockholm: Royal Institute of Technology. 2008.
- Taylor, S. and Spicer, A. "Time for space: A narrative review of research on organizational spaces". *International Journal of Management Reviews*. no. 9. 2007. p. 325-346.
- Tilden, F. *Interpreting our Heritage: Principles and Practices for Visitor Services in Parks, Museums, and Historic Places*. Chapel Hill: University of North Carolina Press, 1957.
- Walczak, B.M. "The Image of Industrial Heritage: the Case of Łódź" in: Kepczynska-Walczak, A. (ed.) *Envisioning Architecture: Image, perception and Communication of Heritage*, Łódź: Politechnika Łódzka, 2015. p.17-26.
- Walczak, B.M. *Zespoły fabryczno-mieszkalne w europejskim przemyśle włókienniczym w latach 1771-1914. Geneza-Rozwój-Typologia*. Łódź: Politechnika Łódzka. 2010.
- Wejchert, K. *Elementy kompozycji urbanistycznej*. Warsaw: Arkady. 1974.
- Zukin, S. *Loft living: Culture and capital in urban change*. New Brunswick: Rutgers University Press. 1989.

(Re)creation of the Socio-Spatial Identity of a Postindustrial City

Introduction

The aim of the paper is to present and discuss a challenge of re-identification of the postindustrial city image based on the case of Lodz, Poland. It is associated with both, the attitudes and expectations, with the perception of a city as a citizen and as a visitor. Space and time construct a background for the social identification with the place, and strengthen its meaning.

The study will show and evaluate a design task undertaken in winter semester 2016/2017 at Lodz University of Technology where thirty six students worked out solutions defined by the problem how to promote the city and revitalisation in the context of EXPO. Due to “Computer Methods in Architecture III” course learning outcomes, it was required to support development of ideas with digital tools and parametric design techniques.

The project has taken into account plans for the city centre revitalisation and has become a part of promotional activities associated with the fact that the City of Lodz is applying for hosting International EXPO in 2022. Since the motto for EXPO 2022 proposed by Lodz is “City Re:Invented”, the main target has been formulated as improving the quality of life through revitalisation process. Both, the quality of life and revitalisation, have broad definitions, therefore, for the purpose of this study, the concepts will be presented in the context of refining built environment, enhancing leisure activities in urban space and experiencing local identity.

Background

Quality of life

In the last decades there has been a growing interest towards the concept of “Quality of Life” (QoL), not only in the bio-medical field, but also in other areas, such as sociology, psychology, economics, philosophy, architecture, journalism, politics, environment, sports, recreation, advertisements¹.

QOL is not a new notion. Despite its complexity, generally, it refers to the well-

¹ Barcaccia Barbara et al. “Defining Quality of Life: A Wild-Goose Chase?”. *Europe’s Journal of Psychology*. vol. 9(1). 2013. p. 185.

being of people as well as to the well-being of the environment in which these people live². It is determined with objective factors and also with subjective perception of factors which influence human life. Its common understanding is related also to the external circumstances of an individual's life, where the quality of urban environment and aesthetic surroundings along with affection to the place of living are the most crucial indicators. These aspects are highlighted since they are crucial for the topic and problematics of this paper. To reveal more, the study results by Brajša-Žganec, Merkaš and Šverko show that engagement in leisure activities contributes to subjective well-being³ because they provide opportunities to meet life values and needs. Through participation in leisure activities people build social relationships, feel positive emotions, acquire additional skills and knowledge, and therefore improve their quality of life. Thus, it has a significant impact on their subjective notion of well-being, their happiness and their life satisfaction.

Actually, the QoL concept has potential as a tool for decision makers and should act as key argument in revitalisation processes.

EXPO 2022 as part of revitalisation process

An extremely dynamic development of Lodz as an industrial city in 19th century and the collapse of textile industry in the early 1990s which forced the city "to be reinvented anew" has been well described⁴. Indeed, Lodz is undergoing an immense revitalisation process. It has started already and what has been done till now, besides the revitalisation of tenement historical buildings in the city core, is the railway located in the city centre moved underground. As a result, a huge area on the surface has been planned for new buildings and the site of EXPO 2022. There are also old buildings of historical value adapted to new functions. The most spectacular one is the EC1 Lodz Power Plant Complex converted into cultural and artistic functions.

As it was mentioned at the beginning, Lodz is bidding for hosting International EXPO 2022. The idea of Poland and Lodz is to return the EXPO to the city centre. Its goal is more than promote the city – it is to revitalise the downtown. The keynote for the event is "City Re:Invented". That is why tens of hectares previously occupied by the railway are to be re-used. It is where the exhibition grounds are planned. A huge downtown block surrounded by Narutowicza, Piotrkowska, Tuwima and Kopcińskiego streets, encompassing more than 100 hectares, will be rebuilt significantly. The neglected central quarter is to be transformed into a New Centre of Lodz (NCL) over the next few years. This is one of the largest urban challenges in the city's history. There is no doubt the location is a great challenge but also a chance to bring life to the city, to build it not only for the EXPO visitors but for everyday citizens wellbeing.

² The Quality of Life Concept: A Potential New Tool for Decision-makers. Environmental Studies Division, Environmental Protection Agency. 1973.

³ Brajša-Žganec, Andreja; Merkaš, Marina; Šverko, Iva. "Quality of Life and Leisure Activities: How do Leisure Activities Contribute to Subjective Well-Being?". *Social Indicators Research*. vol.102. 2011. p. 81-91.

⁴ Walczak, Bartosz M. "The Image of Industrial Heritage: The Case of Lodz" in: Kepczynska-Walczak, Anetta (ed.), *Envisioning Architecture: Image, Perception and Communication of Heritage*. Lodz: Lodz University of Technology. 2015. p. 23.

Actually, the visions for the City of Łódź 2020+ have been expressed in the form of the main keynotes such as a higher quality of life, inclusive and varied public spaces, social cohesion, creative atmosphere, well-kept heritage, living culture and more inhabitants in a city centre⁵.



Fig. 01. Lodz historic city core and the New Centre of Lodz (NCL).

Source: Anetta Kepczynska-Walczak.

Perception of a city identity

According to Morello and Piga⁶, “the physical and sensory experience of places, which includes a multiplicity of aspects, contributes to the personal construction of the mental image of places. The visual access to places, the distance or immersivity that relates us to them, the ways and speed of approaching them, the climate conditions of the atmosphere, all these facts together inevitably affect the formation of mental images based on the senses and in particular on the sight.”

Since perception depends on personal abilities, education and activated senses, experts may perceive other elements of the environment than laymen⁷. What is more, they may perform different attitudes to the experience and knowledge derived from it. Additionally, there is a great distinction between perception of residents and people from outside. “In this respect, heritage has a dual role to play: it is the central focus of the visitors activities whilst at the same time being a fundamental element in the construction of local community identity. The same heritage stimulates, however, different images for its depositaries and for tourists.”⁸

⁵ *City Reinvented*. Lodz: Urząd Miasta Łodzi. 2016.

⁶ Morello, Eugenio; Piga, Barbara E. A. “The Image of Productive Landscapes: A Method for the Perceptual Analysis of Industrial Heritage” in: Kepczynska-Walczak, Anetta (ed.), *Envisioning Architecture: Image, Perception and Communication of Heritage*. Lodz: Lodz University of Technology. 2015. p. 92-93.

⁷ Walczak, Bartosz M. op.cit. p.18.

⁸ ibidem. p. 23.

In the case of Lodz, negative and positive connotations related to industrial heritage may strongly influence perception of re-created identity of the city.

The project

As it was described at the beginning, the task for students was defined in the form of a problem to be challenged. First, an introductory presentation focused on EXPO 2022 theme and the revitalisation process in Lodz was organised to give some background for the project. Then, students were provided with instructional classes in parametric digital design. It was planned the final outputs would be in the form of 3D printed and laser-cut scaled mock-ups as well as computer visualisations and technical drawings. Thus, the practical part of the project perfectly fulfilled “Computer Methods in Architecture III” course learning outcomes.

There were thirty six students developing their individual design proposals in the first phase and then, eleven most promising concepts were chosen for further development. The decision was made after students’ presentations (Midterm Assessment) with the participation of the City Council. Thus, the second phase of the project based on group work. It is necessary to stress that Lodz City Council was involved in the project from the beginning.

It was expected participants would design proposals which could promote the idea of EXPO 2022 while supporting the revitalisation process. So, students focused on the spatial aspects as well as citizens’ needs (social aspects). As a result, three key notions were examined, viz.: space, time and meaning. In particular, space was interpreted in the context of urban regeneration and improvement of the quality of life. Time was considered as an impact of the past on presence and future. And finally, meaning in most cases merged the two by recalling local identity values.

What makes results even more interesting is the fact that participating students were from different countries, with various cultural background and, what is more, presented different skills and design approach.

The titles of the final design proposals were as follows: “Lodz Genius Loci“, “Re:Connection“, “Urban Tap“, “Spool Pavilion“, “Folk Interactive Bench“, “Back To Childhood“, “Brick Reinvented“, “Public Toilet Unit“, “Bright Boat“, “Gift Box Brick“, “Bike Bell”. To illustrate the results, five out of eleven projects will be described in more detail.

Lodz Genius Loci

A unique history of the city, its dynamic growth, prosperity, then collapse, and finally the rise towards revitalisation and EXPO 2022, has become an inspiration for the project. Students proposed an installation for a public space telling the story of the city on specially designed panels visualising time: past, present and future, in metaphorical geometrical form. Colour code was taken from the EXPO logo. This light semi-transparent structure can serve as a meeting point, offering not only a historical path to follow but also a shadow in a sunny day and creative space for children. What is more, students made proposal for other cities in Poland to place this installation in a way it would point geographically towards Lodz and EXPO 2022.



Fig. 02. "Lodz Genius Loci" project.

Source: Lucia Barancokova, Alvaro Soriano Lazaro, Ongan Caglar.

Re:Connection

A task undertaken in this project was to make connection between Piotrkowska Street, the main historical area in Lodz, and New Centre of Lodz (NCL). Due to the new main railway station, and the EXPO 2022 site it is expected many people will use the area not only for commuting but also for visiting, walking and leisure. Therefore, a neglected empty plot at the corner of Sienkiewicza Street and Traugutta Street, being half-way between the railway station and Piotrkowska Street, was chosen for the project. The proposal focused on revitalisation of the area to make it attractive for all ages. The individual arrangement of modular elements, enhanced by the city of Lodz logo colours create an optimistic atmosphere, and what is more, being visible from a distance, welcome people to spend time there.



Fig. 03. "Re:Connection" project.

Source: Miriama Butkova, Baris Kavraroglu.



Fig. 04. "Urban Tap" project.

Source: Marta Kawińska, Aleksandra Bem, Bartłomiej Grzesznik, Zhouyang Li.

Urban Tap

The quality of water in Lodz is claimed to be the best comparing to other Polish cities. However, it is not promoted enough and still not available to passer byes as it is observed in South European cities. It is worth mentioning, summers in Poland are hot and winters rather cold. So, the proposal was to design a special tap serving cold and warm water. As the overall idea was to improve the quality of living for citizens as well as EXPO 2022 visitors and tourists, students designed an “urban tap” which can be placed in many public spaces in Lodz. According to authors, this installation may become a symbol of a new Lodz identity.

Folk Interactive Bench

It might not be commonly known that Alexander Tansman and Arthur Rubinstein were connected with Lodz. To build on this heritage, music became the motto of presented project. The concept was to evoke a unique atmosphere, based on more senses than sight only, and actually, to educate people by allowing them interact with music. A design itself took inspiration from a special flower pattern, characteristic for traditional regional folk culture. Such interactive bench addressed to local society as well as visitors would attract people and by that contribute to their well-being through positive connotations with leisure as well as educational values.



Fig. 05. “Folk Interactive Bench” project.

Source: Karolina Drózdź, Katarzyna Jackiewicz, Martyna Jankowska, Yiming Gui.



Fig. 06. “Bike Bell” project.

Source: Małgorzata Wlazło-Walewska, Emilia Oworuszko, Wenjing Wang.

Bike Bell

City bikes are still perceived as a new form of transport in Lodz, however, getting increasing popularity. Therefore, bikes make a new image of the city life and its dynamics nowadays. Taking this phenomena into account, students developed an idea of designing a special bike bell, referring to local cultural heritage. Since Lodz has been famous internationally for the Film School, a proposed shape of the bell imitated

a film tape reel with film frames showing well known movies produced in Lodz. On the top of the reel, EXPO 2022 logo was placed to promote the event. Such bell could become a useful product for citizens and, what is more, a promotional souvenir for visitors. There is no doubt, it would enhance local pride and social identification with the city.

Conclusions and final remarks

The aim of design is to improve people's quality of life by facilitating functionality, creating safe and sustainable surroundings, and evoking positive emotions contributing by that to increasing of people's subjective well-being⁹. Referring to the title of the paper, the author's intention was to point out that a postindustrial city identity can be built through recalling the past while taking the improvement of the quality of the environment into consideration at the same time. What is more, our view of the environment changes as time passes, so acceptance of new city lifestyle should be visible in revitalisation process. Hence, spatial quality and social values may benefit from creative attitudes.

To sum up, it is worth noting here, the keynote of the EXPO 2022 in Lodz is "City Re:Invented". Thus, it is expected the EXPO 2022 durable effect will be an urban regeneration of the missing part of the city, woven into the existing urban fabric. What is more, it would most likely become a residents friendly city, because revitalization should improve the quality of life.

A variety of positive social benefits through the process of urban regeneration is expected. Social impacts, also referred to as soft impacts, are those which are intangible and affect individuals within their everyday lives. They are crucial for a successful revitalisation process.

The project conducted in co-operation with the Lodz City Council strongly supported promotion of hosting EXPO in Lodz. Project results revealed complexity of the topic on the one hand, and creativity of students on the other hand. The span of the first set of ideas was immense: from small scale products to build environment improvements. Eleven projects chosen for the second phase development were also manifold. Therefore, a spatiotemporal metaphor as well as urban furniture design or mobile promotional souvenirs can be found in final outcomes.

There is another interesting observation which connect the project with the European Architectural Envisioning Association (EAEA) domain. As the Association focus area is on envisioning, presented work may contribute to the ongoing discussion on how to communicate the three-dimensional representations of our past, present and future built environments, how to present ideas and how to visualise them, including intangible values and abstract concepts in particular.

⁹ Desmet, Pieter M. A.; Pohlmeier, Anna E. "Positive design: *An introduction to design for subjective well-being*". *International Journal of Design*. 7(3). 2013. p. 5-19.

Acknowledgements

The author would like to thank Sebastian Bialkowski, PhD student and tutor at Lodz University of Technology, for his commitment which contributed to the success of the project, and all students taking part in the project: Cristina Avila Palomo, Lucia Barancokova, Aleksandra Bem, Miriama Butkova, Ongan Caglar, Francisco Jose Catalan Tamarit, Magdalena Chyła, Weronika Czernikowska, Paulina Dobroszek, Karolina Drózdź, Ezgi Gani, Bartłomiej Grzesznik, Yiming Gui, Katarzyna Jackiewicz, Martyna Jankowska, Baris Kavraroglu, Marta Kawińska, Maria Kierzkowska-Klys, Daria Leśniak, Zhouyang Li, Eva Losada, Piotr Mrówczyński, Alexis Ortega Blanes, Emilia Oworuszko, Sylwia Pietrzak, Paula Popczak, Alberto Prieto Arranz, Joanna Sobczak, Albert Solanes Pardo, Alvaro Soriano Lazaro, Anna Supera, Wenjing Wang, Jan Wara-Wąsowski, Małgorzata Wlazło-Walewska, Xuejiao Xu, Alicja Zbrojewska. Special thanks go to Maciej Adamczyk from the City of Lodz EXPO 2022 Team.

Bibliography

- Barcaccia Barbara et al. "Defining Quality of Life: A Wild-Goose Chase?". *Europe's Journal of Psychology*. vol. 9(1). 2013. p. 185–203.
- Brajša-Žganec, Andreja; Merkaš, Marina; Šverko, Iva. "Quality of Life and Leisure Activities: How do Leisure Activities Contribute to Subjective Well-Being?". *Social Indicators Research*. vol.102. 2011. p. 81-91.
- City Reinvented. Lodz: Urząd Miasta Łodzi. 2016.
- Desmet, Pieter M. A.; Pohlmeier, Anna E. "Positive design: An introduction to design for subjective well-being". *International Journal of Design*. 7(3). 2013. p. 5-19.
- Morello, Eugenio; Piga, Barbara E. A. "The Image of Productive Landscapes: A Method for the Perceptual Analysis of Industrial Heritage" in: Kepczynska-Walczak, Anetta (ed.), *Envisioning Architecture: Image, Perception and Communication of Heritage*. Lodz: Lodz University of Technology. 2015. p. 92-100.
- The Quality of Life Concept: A Potential New Tool for Decision-makers. Environmental Studies Division, Environmental Protection Agency. 1973.
- Walczak, Bartosz M. "The Image of Industrial Heritage: The Case of Lodz" in: Kepczynska-Walczak, Anetta (ed.), *Envisioning Architecture: Image, Perception and Communication of Heritage*. Lodz: Lodz University of Technology. 2015. p. 17-26.

Index of Authors

A

Ali, Ahmed K. 138
Anandan, Shivanthi 203

B

Bai, Lin 18
Bar-Eli, Amos 38
Boeri, Antonio 196
Boffi, Marco 244
Breen, Jack 252
Buchanan, Alexandrina 30
Burns, Sean 132

C

Crotch, Joanna 88

D

Dalton, Ruth 355
Deakin, Isabel 88
Deeg, Lohren 132
Dikeos, Meliti 96
Di Mascio, Danilo 355

E

Eggink, Harry A. 65
Elwazani, Salim 347

G

Golden, Saul 269

H

Harigai, Masaru 171
Hong, Seung Wan 146
Huber, Amy 315

I

İnan, Derin 325

K

Kalantar, Negar 310
Kalay, Yehuda E. 146
Karczewska, Zuzanna 73
Karimi, Zamila 234
Kasahara, Maki 46
Kepczynska-Walczak, Anetta 371
Kim, Lora 96

L

Langhorst, Joern 121
Laurent, Lescop 226
Lesko, Thomas M. 333
Liberto, Giovanni di 244

M

Matsushita, Kiwa 46, 80
McManus, Margaret 24
Miguet, Francis 163
Milovanovic, Julie 163
Mizutani, Akihiro 46
Moreau, Guillaume 163
Mounayar, Michel 188

N

Nasu, Satoshi 18
Nevescanin, Antonio 54
Nicholas, Diana 203

O

O'Bryan, Mark 114
Oliveira, Filipe X. 260

P

Pak, Burak 196
Pankiewicz, Mateusz 210
Petri, Valentina 104
Piga, Barbara E. A. 104, 244
Platt, Christopher 154

Purdie, Cameron 295

Putra, Yvette 9

R

Rainisio, Nicola 244

Rudnicka-Bogusz, Marta 277

S

Sanza, Paolo 218

Schaumann, Davide 146

Sheikhoharam, Ehsan 302

Siret, Daniel 163

Stellingwerff, Martijn 288

Strong, Ingrid 96

T

Tajika, Kazeno 171

Tsumita, Hiroshi 80, 171

U

Uddin, Saleh 178, 234

W

Walczak, Bartosz 363

Webb, Nicholas 30

This publication is the proceedings of all the papers accepted and presented at the 13th biennial International Conference of the European Architectural Envisioning Association. The conference – with the theme Envisioning Architecture: Space/Time/Meaning – was held in the Glasgow School of Art in September 2017 and was organized by the Mackintosh School of Architecture and the School of Simulation and Visualization, with assistance from the City of Glasgow College. It coincided with an Exhibition of original drawings of Scotland's other renowned architect Alexander "Greek" Thomson, hosted by The Lighthouse - the nation's Centre for Architecture and Design.

The papers – in approximate equal numbers from Europe, North America and Japan, offer an eclectic representation of the variety of ways in which we envision architecture and its related disciplines, from analogue to digital. No attempt has been made to classify them – rather they are presented as they were received, to stimulate diversity, cross-reference, comparison and inspiration.

Enjoy the publication and look out for the 2019 Conference at eae.net.wixsite.com/eaea.

Architecture &
Design Scotland
Ailtearachd is Dealbhadh na h-Alba

CITY OF GLASGOW
COLLEGE

PEOPLE
MAKE
GLASGOW

THE GLASGOW
SCHOOL OF ART

The Lighthouse
SCOTLAND'S CENTRE FOR DESIGN AND ARCHITECTURE

GIA



IO DESIGN

THE GLASGOW ART CLUB
150
1867 2017