

An Improved Constant Voltage Based MPPT Technique for PMDC Motor

Mohammed Asim¹, Mohd Tariq², M.A. Mallick³, Imtiaz Ashraf⁴

^{1,3}Department of Electrical Engineering, Integral University, Lucknow, India

²School of Electrical and Electronic Engineering, Nanyang Technological University, Singapore

⁴Department of Electrical Engineering, Aligarh Muslim University, Aligarh, India

Article Info

Article history:

Received Apr 17, 2016

Revised Nov 21, 2016

Accepted Dec 4, 2016

Keyword:

MATLAB[®]/SIMULINK

Maximum power point techniques (MPPT)

PMDc

Proportional-integrator (PI)

Stand-alone photovoltaic (SAPV)

ABSTRACT

Stand-alone photovoltaic (SAPV) systems are being used in remote areas and are being seen as one of the promising solution in this regard. The SAPV system as presented in the paper consists of solar PV panel, a DC-DC converter, a controller and a PMDC motor. The current-voltage and power-voltage characteristics being nonlinear, the SAPV system require maximum power point techniques (MPPT) control techniques to extract maximum power available from the PV cell. A voltage based MPPT technique which is capable of tracking MPP has been selected because of numerous advantages it offers such as: simple and low cost of implementation. The limitation of constant voltage method is that its efficiency is low as the PV panel has to be disconnected from the load for measurement of the open circuit voltage (V_{oc}). In the presented paper, the authors have removed this limitation by using a pilot PV panel for measurement of V_{oc} . A proportional-integrator (PI) based controller is used in implementation of constant voltage MPP technique and the modeling is done in MATLAB[®]/SIMULINK simulation environment. The simulation results are presented and discussed in the paper, the results shows that the efficiency of the system has increased.

Copyright © 2016 Institute of Advanced Engineering and Science.
All rights reserved.

Corresponding Author:

Mohammed Asim,

Departement of Electrical Engineering,

Integral University, Kursi Road, Lucknow 226026, Lucknow, India.

Email: asimamu@gmail.com

1. INTRODUCTION

Energy crisis and environmental issues are on a rise in today's world. The emphasis is being given to renewable energy sources in order to solve the above problem [1-2]. Renewable energy is being seen as an answer to the global warming issue. It also provides energy security and economic benefits. In today's scenario, among all available renewable energy sources in the world, solar is seen as the most promising [3-4]. It has no moving parts, requires no supervision and little maintenance, is non-polluting and has a life span of 20-30 years with low running costs. It has an added advantage as no large-scale installation is required. Wind energy is also another renewable energy [5], but in this work PV system is only considered.

In recent decade Standalone photovoltaic (PV) pumping system is the most favored solution for electric vehicles, water supply, swimming pool heating systems etc. [6]. It has gained wide acceptability and market share, particularly in rural areas which are devoid of an electric grid and having good amount of insolation [7]. The best use of solar system is made by maximizing the output in two ways. The first one being to track the sun mechanically that is changing the orientation of the solar panel such that it receive maximum solar radiation. The second way is to electrically tracking the operating point which is done by manipulating the load to maximize the power output under changing atmospheric conditions.

The commercially available PV systems generally use inefficient MPPT control or go for directly connected systems [8-9]. The directly connected systems operate at the intersection of load curve

and current–voltage curves of the PV array. This operating point may be at any point on the curve which can be either near the maximum power point (MPP) or far away. A significant amount of the available solar power will be wasted if the operating point lies far away from the MPP [10-12].

The intersection of load characteristics and source characteristics determines operating point in an electrical system. The characteristic curve for a solar PV system which is connected to different resistive load is shown in Figure 1. The system operates at Q1 if the value of resistance is low say R1. The operating point moves to Q2 if the resistance is increased to R2 and then to Q3 as the resistance is further increased to R3. Maximum power can be extracted from the PV system for load resistance of R2. Maximum power can be extracted from PV system if the load can adjust itself to track maximum power point. The I-V characteristic of a solar PV system keeps on changing with temperature and solar insolation. Maximum power can be received from PV system if the load adjust itself accordingly to track the maximum power point. A MPPT which is a high efficiency DC-DC converter which converts the power to a voltage or current level at which MPP is achieved [13].

MPP techniques are used to optimize the power from PV array which depend upon cell temperature, solar insolation and load. A number of maximum power points tracking (MPPT) methods have been developed. Dynamic response, steady state response, sensed parameters, implementation complexity, convergence speed, required number of sensors, and cost. This paper presents a PI based constant voltage method MPPT method in which a pilot panel is used to measure the reference voltage. Simulink model of directly coupled and MPPT connected PMDC motor is made and the efficiency is shown to increase under varying atmospheric condition

2. MAXIMUM POWER POINT TECHNIQUE

A MPPT which is a high efficiency DC-DC converter converts the power to a voltage or current level at which MPP is achieved. This is done by an intelligent algorithm. Maximum Power Point Tracking is an electronic system which makes the Photovoltaic (PV) modules to operate in such a way so as to allow the modules to produce all the power they are capable of. MPPT does not involve physically moving the panel to make them point directly at the sun. The maximum power available is delivered to the load by a fully electronic system that varies the electrical operating point of the modules. MPPT can be used in along with a mechanical tracking system, but the two systems are entirely different. There are many algorithms available in the literature. Among these algorithm the most common being Perturb and Observe, Incremental Conductance, Constant Voltage method.

2.1. Constant Voltage Method

This method gives fastest response as it does not involve perturbation. It is the simplest method among all and has no oscillation around MPP. It works on the basis that ratio of solar panel voltage at maximum power (V_{mpp}) and its open circuit voltage (V_{oc}) is a constant

$$V_{mpp}/V_{oc} = K \quad (8)$$

There are basically two types of constant voltage technique available in the literature. In one method we isolate the solar panel to calculate V_{oc} , then by using equation (8) correct operating point is calculated for a particular value of K whose value depend upon the material of solar cell. Then the array voltage is adjusted till V_{MPP} is reached. The drawback of this method is it is difficult to choose optimal value of K which varies in the range of (73-80) %. Its efficiency is relatively low. The main disadvantage of above method is to calculate V_{oc} , the panel has to be disconnected which leads to momentary power loss.

The duration between two consecutive sampling time is another challenges of the voltage based MPPT. Sample and hold circuits are used to store V_{ref} . If the sampling period is large, hold capacitor will drop [14] and V_{ref} will change leading to energy loss. Moreover if sampling period is large between two sampling intervals, change in atmospheric condition such as temperature or solar insolation will shift MPP, which will again result in loss of energy.

The other method of constant voltage method is the use of pilot panel to calculate open circuit voltage. In order to eliminate above disadvantages [15] suggested use of pilot panel of similar characteristic. Hence the problem of disconnecting PV panel is removed. The characteristic of main PV panel and pilot PV panel may not be similar though of same rating may lead to wrong MPP. A need of extra pilot panel will also increase the cost and space requirement. As shown in Figure 2, a pilot solar panel of same characteristic as that of main solar panel is used to calculate V_{oc} , which eliminate the loss of PV power during V_{oc} measurement as in previous method of constant voltage. The drawback of this method is that it is costlier as an extra pilot panel is being used. Multi Level Inverter is used for integration of solar PV to the grid [16].

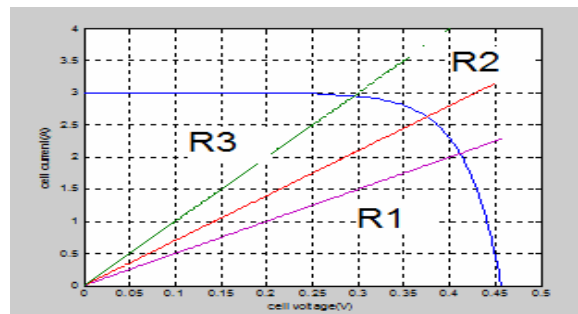

Figure 1. Variation of operating point with loads

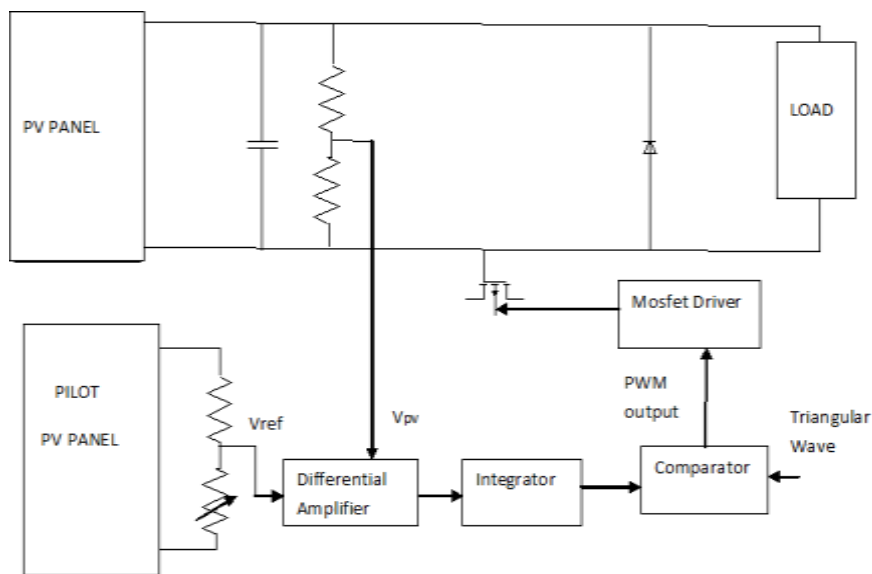

Figure 2. Analog MPPT

2.2. Constant Voltage Controlled MPPT Method for PMDC Motor

The reference voltage is taken as a fraction of V_{OC} . V_{OC} is calculated by the pilot panel which remains open circuited. A PI controller is used to adjust the duty ratio of an MPPT converter in a feedback control system. Constant voltage MPPT requires only one sensor and can be executed with both analogue and digital circuits. A small pilot PV panel of similar characteristic as that of main PV panel is used to measure the open circuit voltage under no load condition. A fraction of the open circuit output voltage of the pilot PV panel, which corresponds to MPP voltage, is used as the reference voltage. The error signal is passed through a PI controller which is compared with a high frequency triangular wave and the signal generated is fed to the gate of GTO switch. The pulse width modulated (PWM) output is used to drive the GTO of a step-down dc-dc converter. The duty cycle of the converter changes till the PV panel voltage becomes equal to the MPP voltage.

3. SIMULATION RESULTS

Simulation was carried up to 5 seconds for various temperature and insolation conditions of PV modules. The different output at different temperatures and for different insolation from 100 mW/cm^2 to 30 mW/cm^2 for PV array is shown in table 1 for directly coupled and for MPPT connected PMDC motor. The array efficiency by $\eta_{\text{array}} = (P_{\text{array}}/P_{\text{max}}) \times 100$ where P_{max} is the maximum power that PV array is delivering to the PMDC motor under given conditions and P_{array} is output power of the PV array. The array efficiency plotted in graph indicates the extent of utilization of PV array. It may be observed that for low insolation the array power is very low. This indicates that operating point of the PV array is far from its maximum power

point resulting in poor array efficiency. Thus, array is poorly utilized at low insolation in a directly coupled system, but for the MPPT connected load the efficiency is seen to increase.

Table 1. Array Power fed to PMDC motor with and without MPPT

Sx	Temp=30°C			Temp=26°C			Temp=20°C		
	Pa	Pmax (WM*)	Pmax (M*)	Pa	Pmax (WM*)	Pmax (M*)	Pa	Pmax (WM*)	Pmax (M*)
100	1591	1525	1555	1646	1579	1608.4	1780	1750	1740.4
95	1509	1446	1500	1562	1494.8	1553	1712	1696.7	1702.9
90	1474	1410	1460	1526	1459	1513.0	1605	1513.8	1596
85	1315	1224	1301	1361	1253.4	1347	1431	1332	1417
80	1232	1036	1091	1275	1148.3	1256.5	1350	1229.9	1331.1
75	1139	1020	1007	1240	1088.7	1220.9	1239	1109	1220.6
70	1054	940.9	991.9	1065	935.07	1007.4	1145	1023	1079.0
65	964.7	835.5	891.6	997.5	863.9	922.1	1049	926.26	969.2
60	932.3	795.2	860.9	963.3	834.3	890.2	1012	891.57	935.4
55	897.1	759.8	828.2	821.7	676.4	758.75	973.6	851.9	899.3
50	801.1	671.3	707.3	797.3	655.3	734.31	931.6	804.9	860.3
45	627.9	427.9	510.2	748	615.8	527.1	801.1	681.73	651.21
40	547.9	411.4	450	565.6	424.6	464.7	592.8	445.1	487.3
35	468.9	319.3	372.2	483.7	329.4	384	506.5	344.9	402.3
30	392	171	212.1	403.9	176.2	218.6	422.2	184.2	228.6

*WM- Without MPPT
 * M- MPPT

The simulation was carried out for temperature ranging from 20°C to 30°C and for solar insolation 100mW/cm² to 30mW/cm². Figure 3 and Figure 4 shows variation of array efficiency with solar insolation and temperature without MPPT and with MPPT respectively. At solar insolation of 100 mW/cm² the array power is 1591 watts, whereas at 30 mW/cm² the array power is 392 watts only. The efficiency is in the range 95%-82% for solar insolation 100 W/m² to 45 W/m² and in the range of 75% -43% for solar insolation 40 W/m² to 30 W/m² for a directly connected system. The efficiency is seen to increase after MPPT is implemented and is in the range 99%-82% for solar insolation 100 W/m² to 45 W/m² and in the range of 80% -54% for solar insolation 40 W/m² to 30 W/m² for a MPPT connected system.

The simulation result of directly coupled PMDC motor is shown in Figure 5 and Figure 7. It shows variation of input load power with solar insolation (MPPT) at T= 30°C and T= 22°C. For T=30°C and solar insolation of 100 mW/cm² the input power to PMDC motor is about 1525 watts, whereas at 35 mW/cm² the load power is about 319.3 watts only. Figure 6 and Figure 8 shows variation of array power with solar insolation (MPPT) at T= 30°C and T= 22°C. For T=30°C and solar insolation of 100 mW/cm² the array power increases to 1555 watts, whereas at 35 W/m² the array power increases to 372.2 watt.

Hence it can be seen from the above figures that the power decreases with decrease in the insolation level as well as with an increase in the temperature. The efficiency of the improved constant voltage method was found to increase in all the cases of insolation.

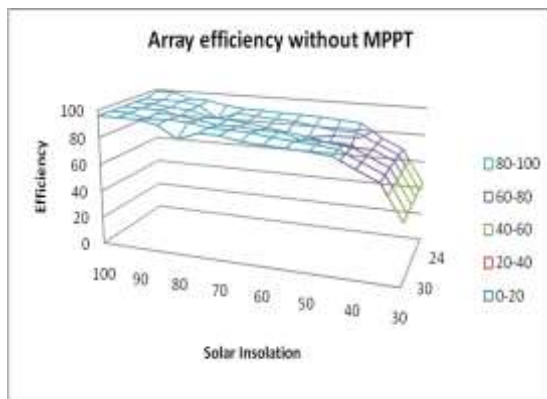

Figure 3. Array efficiency without MPPT for different solar insolation and temperature

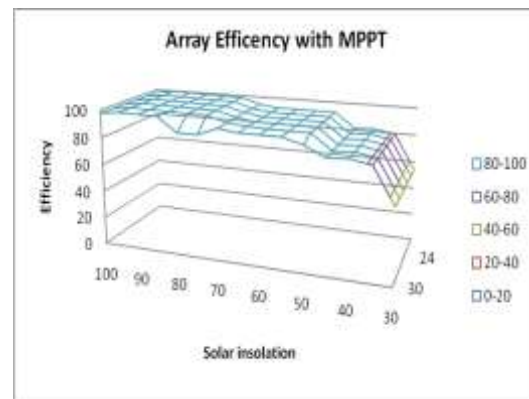

Figure 4. Array efficiency with MPPT for different solar insolation and temperature

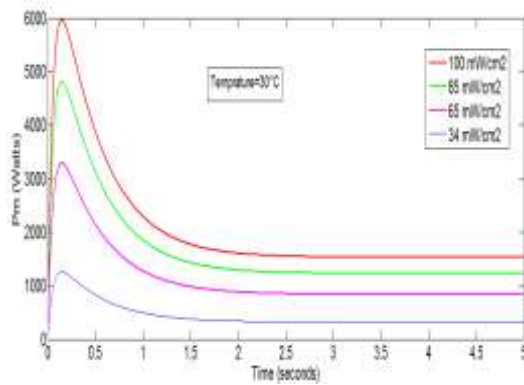

Figure 5. Variation of Pmax of directly coupled system with solar insolation for constant temperature=30°C

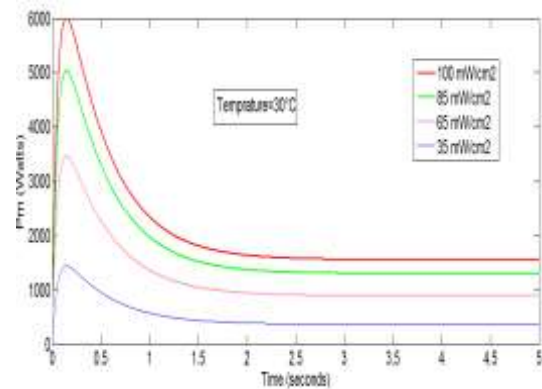

Figure 6. Variation of Pmax of MPPT connected system with solar insolation for constant temperature=30°C

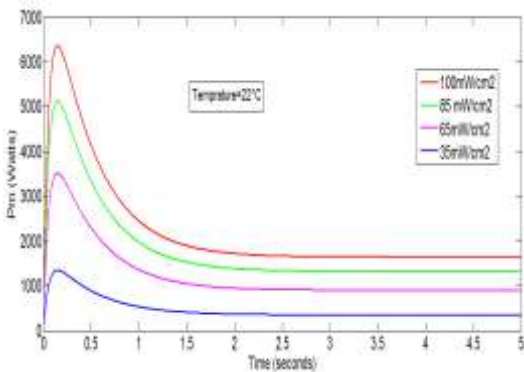

Figure 7. Variation of Pmax of directly coupled with solar insolation for constant temperature=22°C

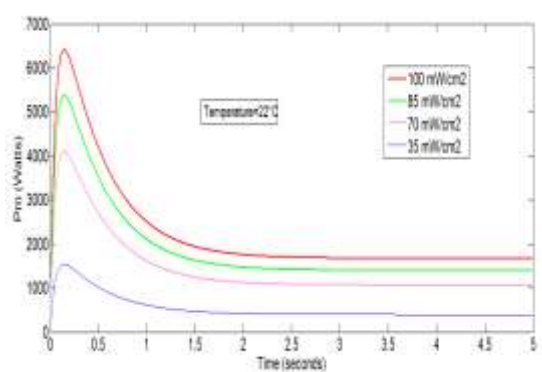

Figure 8. Variation of Pmax of MPPT connected system with solar insolation for constant temperature=22°C

4. CONCLUSION

The power can be maximized from a PV panel by interfacing an MPPT. The MPPT adjust the PV panel voltage to reference voltage. In this paper, directly coupled PMDC motor with PV panel and MPPT connected PMDC motor model has been simulated. An analysis of constant voltage algorithm was done. The effect of isolation and temperature on system behavior is examined and the utilization is calculated under varying atmospheric condition. The MPP tracking system uses constant voltage algorithm in which reference voltage is calculated with the help of pilot panel. The simulation result shows that MPP is tracked under changing isolation conditions. The results were taken at different values of temperature and solar insolation and a graph has been plotted to show the behavior of the system at varying conditions. The findings/results presented in the paper will help in the effective utilization of solar energy resources, especially in remote/isolated area where PMDC motor can be used for water pumping for irrigating the agricultural fields.

REFERENCES

- [1] Lata Tripathi, A.K. Mishra, Anil Kumar Dubey, C.B. Tripathi, Prashant Baredar. *Renewable energy: An overview on its contribution in current energy scenario of India*, *Renewable and Sustainable Energy Reviews*. 2016; 60: 226-233.
- [2] Mohd Tariq, Khyzer Shamsi, Tabrez Akhtar. *Modeling, analysis and development of "hybrid" manual and solar PV based power generation system*. *American Journal of Electrical Power and Energy Systems* 2, 2013; 2: 44-49.
- [3] Askarzadeh, Alireza. *Optimization of solar and wind energy systems: A survey*. *International Journal of Ambient Energy* just-accepted 2016; 1-36.
- [4] Mohd Tariq, Sagar Bhardwaj, Mohd Rashid. *Effective battery charging system by solar energy using c programming and microcontroller*. *American Journal of Electrical Power and Energy Systems* 2, 2013; 2: 41-43.

- [5] A. Tariq, M.A. Husain, M. Ahmad. M. Tariq, "Simulation and study of a grid connected Multilevel Converter (MLC) with varying DC input". In IEEE Conference on Environment and Electrical Energy International Conference EEEIC 2011.
- [6] Bhavnesh Kumar, Yogesh K. Chauhan, Vivek Shrivastava. A comparative study of maximum power point tracking methods for a photovoltaic-based water pumping system. *International Journal of Sustainable Energy* 33, 2014; 4: 797-810.
- [7] Mohd Tariq, S. Yuvarajan. Modeling and Analysis of Self Excited Induction Generator with Electronic load controller supplying static loads. *Canadian Journal on Electrical and Electronics Engineering*, 4(1): 9-13.
- [8] R. Anusuyadevi, P. Suresh Pandiarajan, J. Muruga Bharathi. Sliding Mode Controller based Maximum Power Point Tracking of DC to DC Boost Converter. *Int. Journal of Power Electronics and Drive System (IJPEDS)*, 2013; 3(3): 321-327
- [9] Gudimetla Ramesh, Kari Vasavi, S. Lakshmi Sirisha. Photovoltaic Cell Fed 3-Phase Induction Motor Using MPPT Technique. *Int. Journal of Power Electronics and Drive System (IJPEDS)*. 2014; 5(2): 203-210
- [10] Huaqian Wang, Vinayagam, L., Hao Jiang, Zhi Qiang Cai, Qiang Ni, Hongqun Li. A new MPPT technique for the maximization of overall system output in solar generation. in *Power Electronics and Drive Systems (PEDS)*. 2015; 791-795, 9-12.
- [11] Abu Tariq, Mohammed Asim, and Mohd Tariq. *Simulink based modeling, simulation and Performance Evaluation of an MPPT for maximum power generation on resistive load*. 2011.
- [12] M.A. Elgendy, B. Zahawi, D.J. Atkinson. Comparison of Directly Connected and Constant Voltage Controlled Photovoltaic Pumping Systems, in Sustainable Energy, *IEEE Transactions on*. 2010; 1(3): 184-192.
- [13] Raveendhra, Dogga, Padmanabh Thakur, and Abhisekh Chauhan. FPGA Controlled Power Conditioning System for Solar PV Fed PMDC Motor. *Power Electronics and Renewable Energy Systems*. Springer India. 2015; 321-328.
- [14] Jawad Ahmad. *A Fractional Open Circuit Voltage Based Maximum Power Tracker for Photovoltaic Arrays*. International Conference on Software Technology and Engineering. 2012; 247-250.
- [15] Abu Tariq, M.S.J. Asghar. *Development of an Analog Maximum Power Point Tracker for Photovoltaic Panel*. Proceedings of , The sixth International Conference on Power Electronics and Drive Systems-PEDS 2005, Kuala Lumpur, Malaysia. 2005.
- [16] Mirza Mohammad Shadab, Muhammad Tufail, Qamar Alam, M.A. Mallick," Simulation and Analysis of Grid connected Multilevel converter topologies and their comparison", *Journal of Electrical system and information technology- Elsevier (JESIT)*. Sept. 2014; 1(2): 166-174.

BIOGRAPHIES OF AUTHORS



Mohammed Asim received B.Tech. and M.Tech Engg. degree from Aligarh Muslim University, Aligarh, India in 2007 and 2009, respectively. He is pursuing PhD in Electrical engineering from Integral University, Lucknow. He is working as Assistant Professor in the Department of Electrical Engineering, Integral University, Lucknow, India. His research interests include renewable energy systems, power system and drives. He has many publications in national and international journals and conferences. He also serves as reviewer of reputed international journals.



Mohd Tariq has completed B.Tech in Electrical Engineering from AMU in 2011 with 1st rank in the batch in GATE (score of 99.7 percentile) and 2nd Rank in order of merit (9.59 CPI out of 10.0). He did his M.Tech in Machine Drives and Power Electronics from IIT Kharagpur in 2013. He worked as a Scientist and was attached to the Marine Sensor System group at NIOT, Min. of Earth Sciences, Govt. of India, Chennai, wherein he was involved in many projects which includes the design of high speed underwater BLDC motor with controllers, design of portable power supply for buried object scanning sonar (BOSS) etc. to name few. Presently, he is pursuing PhD at School of Electrical and Electronic Engineering, Nanyang Technological University, Singapore. Mr. Tariq at his young age is the inventor of many US/India patents and has published a large number of research papers in International indexed journals and IEEE conferences. He has academic visit of more than 7 countries. He is recipient of many best research paper awards, scholarship etc. His research interest includes power electronics application in renewable energy and electric vehicles.



M.A. Mallick received BSc.Engg. and M.Sc. Engg. degree from Aligarh Muslim University, Aligarh, India in 1994 and 1998, respectively. He received his PhD degree in the year 2011 from Integral University, Lucknow. He is working as Professor in the Department of Electrical Engineering, Integral University, Lucknow, India. His research interests include renewable energy systems, power system modeling, instrumentation, electrical machines and drives. He is serving as Fellow of IE (India), Associate member of IETE (India). He has many publications in national and international journals and conferences. He also served as reviewer of reputed national and international journals.



Dr. Imtiaz Ashraf is a professor in Electrical Engineering department since 2011. He did his bachelors and master's degrees in electrical engineering and power system and drives respectively from Electrical Engineering Department, AMU Aligarh, India. He obtained his PhD from IIT Delhi in 2005. He taught in different Universities in KSA from 2008 to 2012. He has published around 50 research papers in National and International journals and proceedings of conferences. His field of research is electric power system and drives, renewable energy and energy conservation& management and pollution mitigation.