



Measurement of real-world PM10 emission factors and emission profiles from woodheaters by in situ source monitoring and atmospheric verification methods

C.P. (Mick) Meyer, Ashok Luhar, Rob Gillett and Melita Keywood

May 2008

Final Report of Clean Air Research Project 16
for

Australian Commonwealth Department of the Environment Water Heritage
and the Arts

Enquiries should be addressed to:

Dr. C.P. (Mick) Meyer
CSIRO Marine and Atmospheric Research (CMAR)
PMB1, Aspendale, Vic, 3195
E-mail: mick.meyer@csiro.au
Phone: (03) 9239 4686

Acknowledgements

This research was funded by the Australian Government Department of the Environment, Water, Heritage and the Arts through the Clean Air Research Program.

We would like to thank the following people who contributed substantially to this project.

Ian Morrissey, Bernard Petraitis, and Jamie Harnwell of the electrical and mechanical workshops at CMAR who constructed the sampling units and resolved many of the complex design issues within extremely tight time limits;

Kate Boast and Paul Selleck of the chemistry laboratory at CMAR who prepared, weighed and analysed the filters;

Rod and Vanessa Clark, Chris Barnett and the team at Prime Plumbing, Launceston, who installed the monitoring systems on the households in Launceston and who were a total pleasure to work with;

Rob Meyer who assisted with the field campaign in Launceston on many long cold days and in many ways kept the field program on track;

James Doherty, Launceston City Council, who advised on numerous aspects of the project plan and who helped recruit volunteers to the program;

Dr Andrew Seen, University of Tasmania, for his valuable advice on the design of the project and for his assistance in recruiting volunteers;

Chris Ball, ABC Regional Radio, Launceston, who arranged radio publicity for the project;

Michael Groth, Kelvyn Steer and Mike Power, DEPHA, Tasmania who allowed us access to the Ti Tree Bend AQMS, and who assisted with the installation of instruments, data collection and processing;

Dr John Todd, Eco-Energy Options Pty Ltd, for his advice, and for kindly providing the data for Figure 4.18;

Finally we would like to thank the residents who volunteered their heaters to the testing program and without whose cheerful and tolerant help this project would not have been possible.

Copyright and Disclaimer

© 2008 CSIRO To the extent permitted by law, all rights are reserved and no part of this publication covered by copyright may be reproduced or copied in any form or by any means except with the written permission of CSIRO.

Important Disclaimer

The views and opinions expressed in this report do not necessarily reflect those of the Commonwealth Government. While reasonable efforts have been made to ensure that the contents of this publication are factually correct, the CSIRO and the Commonwealth Government do not accept responsibility for the accuracy or completeness of the contents, and shall not be liable for any loss or damage that may be occasioned directly or indirectly through the use of, or reliance on, the report. Readers should exercise their own skill and care with respect to their use of the material published in this report and that users carefully evaluate the accuracy, currency, completeness and relevance of the material for their purposes.

CSIRO advises that the information contained in this publication comprises general statements based on scientific research. The reader is advised and needs to be aware that such information may be incomplete or unable to be used in any specific situation. No reliance or actions must therefore be made on that information without seeking prior expert professional, scientific and technical advice. To the extent permitted by law, CSIRO (including its employees and consultants) excludes all liability to any person for any consequences, including but not limited to all losses, damages, costs, expenses and any other compensation, arising directly or indirectly from using this publication (in part or in whole) and any information or material contained in it.

Executive Summary

Introduction

Domestic woodheaters are a major source of particle (PM10) pollution in Australia. Although most jurisdictions require woodheaters to comply with the Australian Standard for woodheater emissions (AS/NZ 4013), which includes a particle emissions limit of 4g per kg of wood burnt, there has been growing concern that even compliant heaters frequently do not meet this limit when operated in homes.

The key issue for policy development for air quality and environmental health is the contribution that woodheaters make to ambient concentrations of particulate and gaseous pollutants. A comprehensive understanding of the factors that influence the contribution of woodheaters to ambient PM levels involves at least three steps: verifying the heater's design characteristics, determining in-service emission PM factors for woodheaters, and quantifying the contribution of woodheater emissions to the ambient PM levels.

This project was commissioned to investigate the second and third steps by measuring *in situ* the emission rates of woodheaters for a small selection of households in the Launceston air shed in Tasmania. The specific objectives were:

1. To provide an estimate of real-world emission factors for woodheaters in Launceston;
2. To provide an estimate of wood- heater usage patterns and PM10 emission rates, and
3. To assess whether CSIRO's transport model (TAPM) using in-service emission factors as determined through this study can accurately predict PM concentrations in the Launceston airshed.

Principal Findings

1. The 24h average emission factors for PM10 (PM10-EF) from the 18 houses successfully tested ranged from 2.6 g PM10 (kg fuel burned)⁻¹, with an average of 9.4 g PM10 (kg fuel burned)⁻¹. These results correspond closely with similar tests conducted in New Zealand. The National Pollutant Inventory (NPI) uses an emission factor of 5.5 g PM10 (kg fuel burned)⁻¹ to estimate the contribution of woodheaters to the ambient PM10 load.
2. The main determinant of PM10-EF was combustion efficiency, which in turn was determined by the air supply rate. While some woodheaters were operated mostly with the dampers set fully open, most were operated at significantly reduced air flow leading to higher PM10 emissions.
3. During week-days, woodheaters in the monitored households were mostly used during the late afternoon and evening. On weekends woodheater use commenced earlier and finished later. Where woodheater operation continued overnight, there was no evidence that overloading occurred. Nor was there any evidence that woodheaters were allowed to smoulder overnight; in contrast they appeared to be refuelled periodically throughout

4. The prediction of ambient PM concentrations, using atmospheric transport models combined with an emission factor of 5.5 g PM10 (kg fuel burned)⁻¹ (as specified in the National Pollutant Inventory), substantially underestimates ambient PM10 concentrations, when compared against measured concentrations. However, using the mean *in situ* emission factors of 10 g PM10 (kg fuel burned)⁻¹, observed in both this study and in New Zealand studies, coupled with an approximation of the observed daily patterns of heater use leads to good agreement between predicted and measured PM10 levels without any model parameter adjustments. This is good evidence that the emissions source estimate is correct and therefore that the results from the survey are representative of the Launceston air shed.

Policy Implications and Limitations

The principal conclusion from these findings is that the AS/NZ 4013 test protocol does not adequately reflect in-service emissions performance. There is, therefore, a strong case for developing a new test cycle that accurately reflects the way in which heaters are used in homes.

The current NPI emission factor for PM10 from woodheaters, of 5.5 g PM10 (kg fuel burned)⁻¹ significantly underestimates the contribution of woodheaters to the ambient particle load. A revised value of 10 g PM10 (kg fuel burned)⁻¹ should be used, which reflects the true in-service performance of woodheaters, when developing inventories and conducting atmospheric dispersion modelling.

There are some technical issues in the sampler design that need to be resolved and improved. The most important of these is to refine the primary diluter design to minimise or remove the risk of blockages. It would also be useful to compare the performance of the *in situ* monitoring system against the performance of the AS/NZ 4013 dilution tunnel. This would provide a direct calibration of the field sampling system against the AS/NZ 4013 standard, and focus attention on the AS/NZ 4013 test cycle, rather than the monitoring system.

Additional areas that could be usefully addressed include:

1. Development of surrogate measures of *in situ* heater use or performance. Flue temperature, for example, has proved to be a good indicator of the timecourse of heater use, including information on air flow control. Improvements to heater performance in the long term require emissions to be characterised by combustion parameters, such as combustion efficiency, that can be easily measured and controlled. Without this, continued heater design is likely to be haphazard and expensive.
2. Development of methods for determining the spatial distribution of woodheater use and emissions in major air sheds such as Launceston. This is required for accurate dispersion modelling and is currently a significant source of uncertainty

Contents

1	Introduction	9
1.1	Purpose	9
1.2	Background.....	9
1.2.1	Previous work	10
2	Project Design	11
3	Methodology	13
3.1	Sampler design.....	13
3.2	Flue extension and primary diluter	16
3.3	Analysis unit.....	18
3.4	Household Selection.....	20
3.5	Operating Protocol.....	23
3.6	Data analysis	23
3.6.1	Emission rates	23
3.6.2	Emission factors.....	24
3.6.3	Sensible heat emission	25
3.6.4	Flue gas concentrations.....	25
4	<i>In situ</i> measurement of woodheater emissions	26
4.1	Sampler performance	26
4.2	Household woodheater usage patterns.....	28
4.3	Flue temperature, flow rate and emissions.	36
4.4	Particle emission chemistry	37
4.4.1	Chemical tracers for woodsmoke.....	37
4.4.2	Estimation of PM10 in the Launceston air-shed contributed by woodheaters	40
4.5	<i>In situ</i> emission factors	46
5	Emissions in the Launceston basin	52
5.1	Modelling PM10 exceedences due to woodheater emissions in Launceston.....	61
5.1.1	New emission factors	61
5.1.2	TAPM.....	63
5.1.3	Model results.....	64
6	General discussion and conclusions	65
	References	68
	Appendix A	72
	Appendix B	75

List of Figures

Figure 1-1.	Location of Launceston and the Ti Tree Bend monitoring station in Launceston.	11
Figure 3-1	Schematic diagram of the sampling system.	15
Figure 3-2	The flue extension with primary diluter installed fitted <i>in situ</i> to a woodheater flue	16
Figure 3-3	The effect of venturi volumetric air flow rate on sample dilution ratio	17
Figure 3-4	Calibration of the flue extension against measured flow using an Annubar flow meter.	17
Figure 3-5	Schematic layout of the analyzer unit	19
Figure 3-6	View of the analyzer unit containing air supplies, secondary diluter, particle and gas sensors and particle filter samplers.....	19
Figure 4-1	Test 15. Timecourse of A. PM, CO ₂ and CO emissions and B. temperature of the flue gases at the exit to the flue.	27
Figure 4-2	An example of intermittent blockages in the venturi of the primary diluter. The temperature timecourse indicates the combustion rate. Test 17	28
Figure 4-3	Test 8. Timecourse of a heater used mostly for evening use on both weekdays and weekends. A. Flue concentrations of PM, CO ₂ and CO, B: ambient and flue temperature, C: flow rate of flue gases. Arrows indicate changes in damper setting	29
Figure 4-4	Test 8. Timecourse of a heater used mostly for evening use on both weekdays and weekends. A. PM, CO ₂ and CO emission rate B: daily PM10-EF, C: Cumulative total C and heat emitted.	30
Figure 4-5	Test 9. Timecourse of A. PM, CO ₂ and CO emission and B. temperature from a heater used extensively on a weekend.	31
Figure 4-6	Test 21. Timecourse of A PM10, CO ₂ and CO emissions and B, flue gas temperature from a during daytime operation during the week.....	32
Figure 4-7	Test 19. Timecourse of A: PM, CO ₂ and CO emissions, and B: Temperature and flue gas flow rate for a heater operates in the evening on Thursday and Friday.	33
Figure 4-8	Average daily timecourse of emissions from heaters in the Launceston air-shed on weekdays and weekends. Emission of sensible heat, CO ₂ , and PM10	34
Figure 4-9	Average daily timecourse of emissions from heaters in the Launceston air-shed on weekdays and weekends. A: PM10-EF. B: CO-EF	35
Figure 4-10	The relationship between flow rate of flue gas and flue gas temperature at three houses in Launceston. Blue: Test 21, Red: Test 15; Magenta: house 4. Variations in intercept are correlated with damper setting. Most of the time test 21 had dampers closed. The PM emissions ranked 2 nd highest.	36

Figure 4-11	Major chemical species produced during decomposition of cellulose and hemi-cellulose at temperatures greater than 300°C (Elias et al., 2001).	38
Figure 4-12	Relationship between levoglucosan mass fraction and potassium mass fraction in samples collected from 16 woodheaters in Launceston.	39
Figure 4-13	The relationship between combustion efficiency and (a) levoglucosan EF (circles) and (b) the fraction (%) of PM10 formed from levoglucosan.	42
Figure 4-14	Relationship between levoglucosan fraction of PM10 and 14-h mean PM10 mass concentrations measured in Launceston during winter 2002.	45
Figure 4-15	The contribution of total organic matter to the PM10 mass concentration contributed by woodsmoke.	46
Figure 4-16	A: PM10-EF and B: CO-EF measured in all houses tested in the Launceston air-shed in this study. The PM10-EFs are in rank order. The mean PM10-EF is 9 g PM (kg fuel burned) ⁻¹	48
Figure 4-17	Correlation between PM10-EF and CO-EF measured in this study. Each point is the average of all daily PM10-EF factors for each test. The bars are standard errors of the mean.	49
Figure 4-18	Comparison between the effect of combustion efficiency on PM10-EF measured during 4013 tests conducted by Gras et al. (2002) and the real-world PM10 emission factors measured in this study	50
Figure 4-19.	Comparison of the results of this study with a summary of three studies of in-service emission factors of Woodheaters in New Zealand (from Todd, 2008). Each test is the average of up to 7 days in-service operation of a single heater. The results are ranked by magnitude.	51
Figure 5-1	Seasonal cycle of A: daily maximums and minimum air temperature, and B: Daily mean and maximum 1-h average PM10 concentration observed at Ti Tree Bend, Launceston during 2007	53
Figure 5-2	Woodsmoke PM10, CO and NO _x at Ti Tree Bend, May to September 2007. A: Correlation between PM10 and CO-C. B: Correlation between CO-C and NO _x -N.	55
Figure 5-3	Diurnal cycles in pollutants at Ti Tree Bend. Launceston from May to October 2007, A: PM10, CO and NO _x concentrations. B: Diurnal variation in the PM-CO and the NO _x -CO emission ratios	57
Figure 5-4	Relation between PM10-EF and PM10 to CO emission ratio measured during the AS 43013 tests conducted by Gras et al. (2002) and in this study. A PM-CO emission ratio of 50 corresponds to an PM EF of less than 1 g PM (kg fuel) ⁻¹	58
Figure 5-5	Diurnal variation in PM-CO emission ratio for all households tested in this study.	59
Figure 5-6	PM10/CO woodheater source function and observed concentration ratio at Ti Tree Bend May to September	60
Figure 5-7	Comparison of the number of exceedences of the PM10 Air NEPM determined from the modelled concentrations (with various emission options) with the observed number at the Ti Tree Bend	65

List of Tables

Table 1	Households tested in the study and their average daily fuel use during the week and on the weekends.....	21
Table 2	PM10 mass fractions of levoglucosan, mannosan and potassium found in particulate collected from 16 woodheaters in Launceston.	41
Table 3.	Concentrations of PM10 gravimetric mass, levoglucosan, organic carbon (OC), elemental carbon (EC) and total organic matter (TOM) in particulate samples from Launceston, Tasmania.	43
Table 4	PM10 emission factors for woodheaters.....	63

List of Abbreviations

AQMS	Air Quality Monitoring Station
CARP	Clean Air Research Programme
CE, CEF	Modified combustion efficiency
CMAR	CSIRO Marine and Atmospheric Research
CO	Carbon monoxide
CO ₂	Carbon dioxide
DEPHA	Tasmanian Department of Environment, parks, heritage and the arts
DEWHA	Commonwealth Department of Environment, Water, heritage and the Arts
EC	Elemental carbon
EF	Emission factor
NEPM	National Environmental Protection Measure
NO	Nitric oxide
NO ₂	Nitrogen dioxide
NO _x	Odd nitrogen oxides
nssK ⁺	non-sea-salt Potassium
NSW	New South Wales
NT	Northern Territory
OC	Organic carbon
PAH	Poy aromatic hydrocarbon
PM	Particulate matter
PM10	Particulate matter less than 10 micrometers in diameter
PM2.5	Particulate matter less than 2.5 micrometers in diameter
ppb	parts per billion (1 part in 10 ⁹)
ppm	parts per million (1 part in 10 ⁶)
RAAS	Reference ambient air sampler
TAPM	The air pollution model
Tas	Tasmania
TEOM	Tapered Element Oscillating Microbalance
TOM	Total organic matter
VOC	Volatile organic compound

1 INTRODUCTION

CSIRO Marine and Atmospheric Research (CMAR) received funding under the Department of the Environment, Water, Heritage and the Arts (DEWHA) under the Clean Air Research Program (CARP) to provide a properly constrained measurement of woodheater emissions within a heavily impacted air-shed. This work uses two approaches: the continuous measurement of PM10 and related pollutants from domestic woodheaters by sampling directly from the flue and determining the combined affect of all woodheater emissions in an air-shed by observing the changing concentrations of the emitted pollutants in the atmosphere.

1.1 Purpose

This is the final report for CARP Project 16 “Measurement of real-world PM10 emission factors and emission profiles from woodheaters by *in situ* source monitoring and atmospheric verification methods”.

The purpose of the report is to:

- Describe the methodologies used to measure the weekly timecourse of emissions of PM10 and the associated particulate and gaseous tracers (e.g. levoglucosan), carbon dioxide (CO₂) and carbon monoxide (CO) from approximately 20 households in the Launceston air-shed;
- To provide an estimate of real-world emission factors for the Launceston air-shed; and
- By a comparison of PM10 concentrations predicted using a validated transport model (TAPM) with observations of surface concentrations of PM10 in the Launceston air-shed assess whether the measured emission rates and emission factors represent the air-shed average.

The ultimate purpose of the work is to develop and assess methods for inferring average air-shed emissions from woodheaters using observations of atmospheric concentrations of smoke tracers.

1.2 Background

From the London Smog episodes of the 1950s to photochemical smog in Los Angeles and brown haze in Sydney, particle pollution in major cities of the world is well recognised and acknowledged. However, it is becoming increasingly clear that smaller urban areas may also be regularly affected by air pollution. In addition, though the motor vehicle is recognised as a major source of particles in many cities, the contributions of wood-fire emissions in both large and small urban centres can be very significant. In Australia and New Zealand, there are a number of cities (e.g. Launceston, Armidale and Christchurch) that are severely affected by emissions from wood-fired heaters during winter when heater use is most prolific and meteorological conditions promote the build-up of pollutants.

Whilst standard emissions tests for woodheaters (AS/NZ 4013)¹ may adequately simulate a series of plausible usage scenarios, their applicability to real-world woodheater particle emissions is questionable. Studies in Christchurch (NZ) and Launceston (Tasmania) as well as telephone surveys carried out for the Australian Government Department of the Environment woodheater study (Gras et al., 2002) indicate that many users operate woodheaters in modes which can produce anomalously high particle emissions, at least at some stages during their daily operation. Effective management of woodheater emissions requires an understanding of actual emission rates for installed heaters as they are operated in practice, and policies that are responsive to this information. For example, apparent improvements in heater performance indicated by standardized test methods, may not in fact translate into improved air quality if operator practices or other factors negate improvements in appliance potential performance.

The current study is designed to directly measure emission rates of key pollutants at the flue exhaust on selected households in Launceston (Tasmania). Measurement methods and atmospheric modelling employed in the study are used to derive an effective mean emission factor for the combined woodheater sources and its verification within the main study area – the Launceston air-shed.

1.2.1 Previous work

Launceston (population approximately 100,000) is located in the southern end of the Tamar Valley in eastern Tasmania (Figure 1-1). The Tamar Valley is oriented in a NW–SE direction and is bounded by ridges and hills on both sides that range from 100 m to 1500 m above sea level. The climate is continental. Nocturnal winds are greatly affected by local drainage, i.e. NE and SW katabatic flows, and SE down valley flows. The formation of an inversion layer results from the interaction of NE winds with the tops of ridges which generally conform with the SE–NW orientation of the valley, leading to periods of poor ventilation during winter.

A number of studies have investigated the effect of winter time woodheater smoke on the ambient air quality of Launceston. Early work included a 12-month survey of PM₁₀ mass, aerosol Pb and polycyclic aromatic hydrocarbons (PAHs) in the aerosol at several sites in Launceston (Working Party 1996). This work attributed aerosols during winter chiefly to the pyrolysis of wood, with unfavourable topographical and meteorological features exacerbating the situation. Other investigations in Launceston are described in the Working Party Report and include the determination of PAHs in winter 1990 (revealing the presence of several known carcinogens), and simple dust settlement collections between 1973 and 1986. Keywood et al. (2000) reported on the size-fractionated chemical composition of woodsmoke impacted aerosols and its influence on aerosol scattering coefficients for the winter 1997 period, and Gras et al. (2000) reported on the aerosol microphysical properties for winter 1997. For the same period, Gras et al. (2000) estimated a woodheater source function for PM_{2.5}, equivalent to 11–28 g h⁻¹ per woodheater. Luhar et al. (2006) calculated that the capacity of the Launceston air-shed to carry emissions from woodheaters without exceeding the PM₁₀ NEPM should have occurred in 2007 if trends in replacement of woodheaters with alternative heating methods and the use of

¹ AS 4013 - *Domestic solid fuel burning appliances – method for determination of flue gas emissions* is the Australian Standard that sets maximum allowable particle emissions from woodheaters at 4 g/kg

compliant and non-compliant heaters continued as indicated (up to 2003). In doing this work, Luhar et al. carried out a detailed analysis of PM10 concentrations and NEPM exceedences for 1993 to 2003.

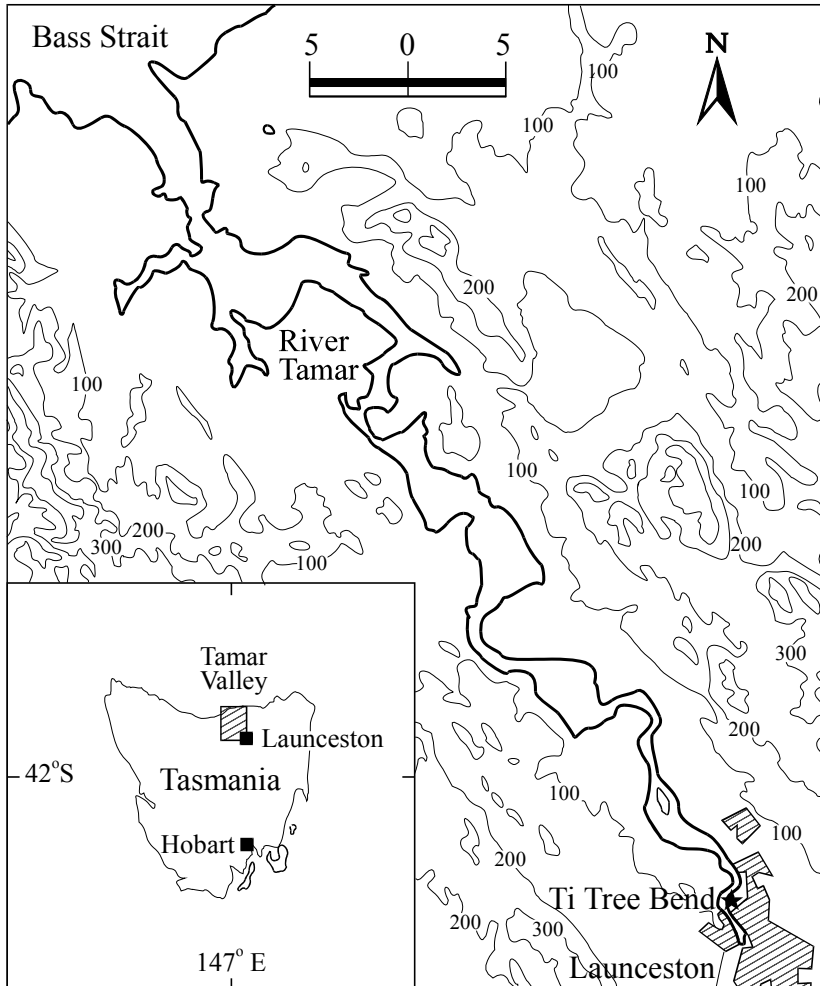

Figure 1-1. Location of Launceston and the Ti Tree Bend monitoring station in Launceston.

2 PROJECT DESIGN

The project primarily focuses on developing a methodology for *in situ* field measurements of woodheater emission rates and emission factors. Because no commercially available and proven systems were available for this purpose, field monitoring of domestic woodheaters, a major part of the study, centred on the technical aspects of designing, testing and commissioning new instrumentation. These instruments were designed for deployment in a winter field campaign to build a database of emissions parameters that are expected to be useful in pollution modelling studies and ultimately in policy development.

The project developed in three stages: instrument development and testing, the field study and the application of the new information to interpreting and extending the knowledge of

woodheater pollution in an urban air-shed. Each stage is dependent on the degree of success of its predecessor. These stages are further described below.

Stage 1 was the development of the sampling instrumentation that could be fitted to woodheater flues to monitor emissions without impacting on householder's normal activities. This phase, involving the design, laboratory testing, limited field testing and refinement of the design occurred during the 2006 winter and the following summer.

Stage 2 was the application of the instrumentation to study the impacts of woodheater emissions in an urban air-shed. There were three components:

- (a) *In situ* testing of a small sample of woodheaters operating in the air-shed to measure emission factors and emissions rates of particulate matter (PM10);
- (b) Characterisation of the chemical composition of emitted particles; and
- (c) Monitoring the ambient concentrations of relevant tracers in the atmosphere of the air-shed.

The objective of component (a) was to test as many houses as practical. Each heater was to be monitored for a minimum of 6 days to collect information on both weekday and weekend. With two sampling systems approximately 24 households could be sampled during the 3 months period of a normal Launceston winter. Potential limiting factors include instrument malfunction, wet weather (which prevents access to house roofs to install and remove instruments) and the challenges of coordinating with the householders' time schedules for access to their properties to install and remove the equipment.

The monitoring programme offered an ideal opportunity to measure the chemical composition of the smoke particles at their source. Useful chemical tracers for biomass combustion include non-sea salt potassium (nssK^+) and the cellulose degradation product, levoglucosan.

It was also important to measure the concentrations of other atmosphere pollution tracers that can be used to distinguish between different emission sources. The PM10 concentration in the Launceston air-shed is routinely and continuously measured by the Environment, Parks, Heritage and the Arts (DEPHA) at their permanent monitoring station at Ti Tree Bend. We supplemented these data with measurements of carbon monoxide (CO) and the nitrogen oxides (NO and NO₂, i.e. NO_x), which in combination give valuable additional information of combustion source identity.

The third stage was the interpretation of the *in situ* emission measurements using the air quality observations. The emissions transport and air quality within the Launceston basin has been modelled in two previous studies (Gras et al., 2000; Luhar et al., 2006). In both cases, the models were limited by insufficient knowledge of the source emission rates and patterns and, to a degree, by insufficient air quality data to constrain and test the model results. Phase 3 builds on this previous work. Information provided by ambient measurements of CO and NO_x concentrations allows examination of source signatures, and exploration of the impacts of other emission sources in the air-shed.

Stage 1 was completed in 2006 with the construction and field testing of the sampler design and the development of the field protocol. Minor issues identified and rectified in the subsequent design included instrument control software, and some design modifications to increase the dilution ratios. The proposed field protocol proved to be practical. Installation and removal of the unit from the households were quick and uncomplicated, and the household diary for recording heater operation and fuel use was acceptable. Scheduling weekly changeovers of the monitors was identified as a potential limitation to the rate at which households could be sampled.

Stage 2 commenced in mid May 2007. While the project proceeded essentially as planned, there were some unexpected issues. The most significant and problematic technical issue was intermittent blockage of the venturi sampler. This was identified early in the campaign and the solution required modification of the sampler. This was largely, although not completely, successful. There were also some minor operational issues. The time required for installation, removal, calibration and servicing of the samplers was greater than estimated. Generally, the changeover between houses took two days to complete which affected the planned 6-day measurement cycle. In order to ensure weekend monitoring on all houses, the period of monitoring was extended for some houses. The most significant of the other unanticipated issues occurred when the householder accidentally disconnected power to the sampler soon after installation. These issues reduced the number of households that could be sampled in a season from a maximum of 24 to 18. For 16 of the houses, the sampling success rate was sufficient to derive emission factors and emission rates for at least several days of heater operation in each period. Including the 2006 measurements 21 houses were tested, of which 19 produced sufficient data to determine emission rates and factors.

3 METHODOLOGY

3.1 Sampler design

The system is required to measure the mass emission rates of particulate matter (PM). While this is a useful parameter, its applicability is limited unless related to wood consumption. In order to relate PM emission rates to wood consumption we also need to measure the emission rates of the main combustion products, carbon dioxide (CO₂) and carbon monoxide (CO) that together account for approximately 97% of the carbon content of the fuel that in turn constitutes approximately 50% of the fuel dry weight. To calculate the emission rate of a trace species *i* (E_i , g min⁻¹) of PM₁₀, CO₂ or CO, we must measure both its concentration (C_i , g m⁻³) in the woodheater exhaust and the flow rate of the exhaust (F , m³ min⁻¹), i.e.

$$E_i = C_i \times F . \quad (1)$$

CO₂ and CO concentrations are measured as mixing ratios (ppm) and PM₁₀ is measured as a mass concentration at standard temperature and pressure (STP). The gas density at the point of

sampling is also required to convert volumetric concentrations to mass concentrations. To determine flue gas density we require the flue gas temperature and pressure.

Combustion gases usually have high concentrations of water vapour which condense when smoke samples are cooled to ambient temperatures. To prevent this, smoke samples must be diluted with dry air at the point of sampling to reduce the water vapour dewpoint to below air temperature. Usually, further dilution is required to bring the particulate and gas concentrations within sensor range. Particulate sampling has a further requirement: to minimise particle deposition onto the walls of the sample lines and the diluters; these components must be electrically conductive with minimum bends (ideally none) and minimum length. The smoke sample must be analysed upstream of any pumps.

For field monitoring of domestic houses it is essential that the equipment:

- Can be installed quickly, easily and safely;
- Is weather proof and free from safety hazards;
- Is unobtrusive and has, ideally, no impact on normal appliance operation or household activity. In particular:
 - The equipment should be self contained and external to the house;
 - It should require no on-site maintenance during the period of operation;
 - It should be possible to monitor and control the equipment remotely to minimise the need for regular house visits to check system performance.

In practical terms, this required a unit that could operate for at least a week without exhausting consumable components such as filters and scrubbers and operated on low voltage DC power. All operational parameters including air flow rates, temperatures and valve status were monitored continuously.

A system was designed to meet these specifications. It comprises three units: a smoke sampling unit, an analysis unit, and a power supply. The smoke sampler consists of a 1.2 m flue extension, 150 mm in diameter with a 100 mm orifice plate fitted 100 mm from one end. The orifice plate provides the means of measuring the flue gas volumetric flow rate. Flue temperature is measured using paired 1/16" stainless steel sheathed type K thermocouples. Midway along the flue extension a smoke sample is drawn via an isokinetic inlet by a venturi. Clean air at a dewpoint of approximately 4 °C powers the venturi jet and also dilutes the smoke sample to reduce its dewpoint as discussed above. This unit is referred to as the primary diluter.

Two airstreams are drawn from the primary diluter to the analysis unit. The sample air stream for particle analysis is drawn through 1/4" copper tubing and is further diluted, in a secondary diluter housed in the analysis unit. The secondary diluter, which is based on the design of Gras et al. (2002), consists of a sample-loop that is alternately filled and then flushed with clean air into a mixing volume. With an appropriate combination of the valve switching duty cycle, the

dilution air flow rate, and the sample-loop volume, dilution ratios between 1:50 to 1:1000 can be achieved. The particle concentration is measured continuously using a DustTrak laser scattering particle analyser (TSI, USA) fitted with a PM10 size selective inlet. In practice, the cutoff size is unlikely to have any impact in this application since most combustion aerosol is below 2.5 μm in diameter and particles larger than 1 μm will be lost by impaction to the walls of the 5 m inlet sample tube. The average weekly PM concentration is determined gravimetrically by sampling onto 47 mm stretched Teflon filters.

A second sample airstream is filtered before passing to a series of gas sensors. CO₂ concentration is measured by NDIR (Gascard II, 10,000ppm range, Edinburgh Instruments, UK) and CO is measured with Polytron-2 electrochemical sensors (0-1000 ppm range, DrägerSensor CO – 68 09 605, Draeger, PA, USA). It was intended to measure NO_x, however the corresponding NO_x sensor proved to have a strong negative interference for CO (0.5ppm at 100 ppm CO) and proved unsuitable for combustion gas analysis in this situation. Alternative sensors are being sourced, but were not available in time for this study.

All critical air flow rates, temperatures and humidities are measured. The particle, chemical, flow and temperature sensor signals are monitored using appropriate industrial data acquisition interface devices (model 4017, 4017+, 4018, Advantech, OH, USA). The system is controlled and the data is logged by a laptop PC. Using a GSM modem supported by appropriate remote-access software, the units can be monitored and controlled remotely.

The analysis unit was located at ground level; external to the house but as close to the flue as was practicable. This unit housed all the air supplies, pumps, filters, zero scrubbers, analytical sensors, data acquisition system and controller, and telemetry. Power to the system is supplied by a high capacity battery charger, supplying a series of DC- to-DC converters which in turn provide regulated power to the system components. A 12V 80Ah low maintenance lead/acid battery connected in parallel to the power supply provides limited backup power in the event of a power failure.

The instrument system is shown schematically in Figure 3-1.

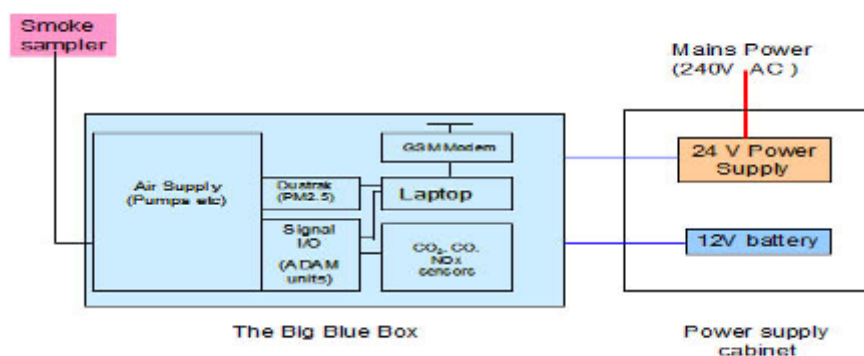

Figure 3-1 Schematic diagram of the sampling system.

3.2 Flue extension and primary diluter

The flue extension comprising orifice plate and the primary diluter (isokinetic inlet, venturi and mixing chamber) are shown in Figure 3-2. Following Gras et al. (2002) a dilution ratio of approximately 1:5 is sufficient to prevent condensation in diluted smoke samples at ambient temperatures above 5 °C.

The performance of the primary diluter is shown in Figure 3-3. The vacuum generated by the venturi jet increases non-linearly with airflow. At high venturi jet velocities the backpressure from the mixing chamber limits the sample air flow rate. In the middle region the dilution ratio is relatively insensitive to venturi airflow. The three isokinetic inlets tested in this study sustained dilution ratios of 4.3, 5.03 and 5.7.



Figure 3-2 The flue extension with primary diluter installed fitted *in situ* to a woodheater flue

Gras and Meyer (2003) reported that volumetric flow rate of the flue gas in woodheaters range up to 4 m³ min⁻¹. A 100 mm orifice plate was found to provide a measurable pressure differential within this range without noticeably restricting smoke flow. The orifice plate was calibrated against an annubar flow meter (Annubar, USA) to confirm that flows within the expected range were measurable with readily-sourced and mechanically-robust transducers

(Figure 3-4). A transducer with a full scale range of 0.25" water (62 Pa) was fitted to the each analytical unit.

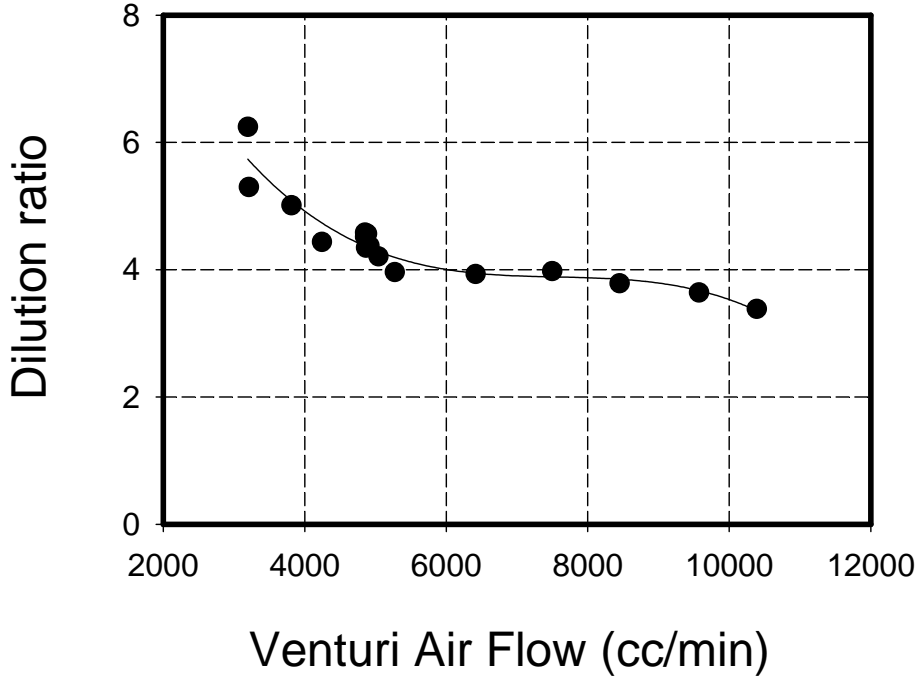

Figure 3-3 The effect of venturi volumetric air flow rate on sample dilution ratio

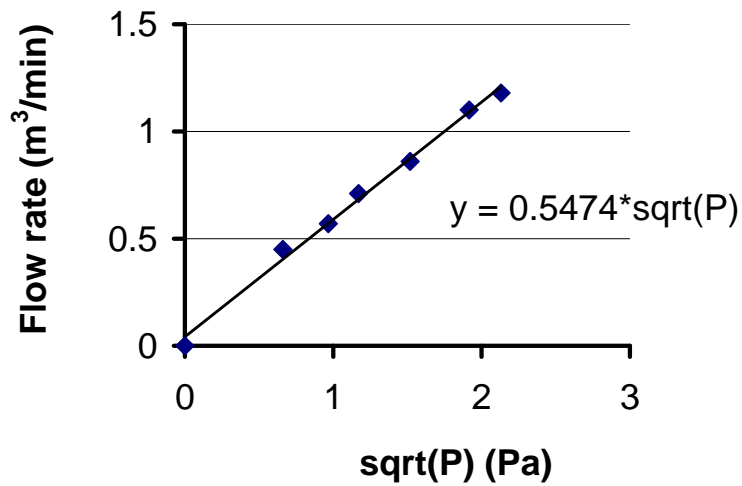

Figure 3-4 Calibration of the flue extension against measured flow using an Annubar flow meter.

3.3 Analysis unit

The analysis unit was housed in a large weatherproof PVC container that could be placed in a convenient location at ground level. It was connected to the flue by umbilical consisting of Teflon and copper sample lines, thermocouple leads, primary diluter air supply and two pressure lines. Ideally, the umbilical should be as short as possible and, in practice, 15m length was found to be adequate in all locations tested.

The design of the monitoring system is shown schematically in Figure 3-5. In brief, the analyzer provides three air streams:

- ambient air, filtered and dehumidified by a Peltier-cooled condenser, which supplies dilution air for the primary diluter;
- a scrubbed and filtered zero air to periodically check the zero readings of the gas sensors; and
- a scrubbed ambient air stream required for the second stage dilutions of the particle and gas samples.

The second dilution of the particle sample stream takes place in the secondary diluter. This diluter comprises a sample loop of 5ml volume which is injected into a dilution air stream at a specified rate. This not only dilutes the sample but also changes the sample stream from negative to positive flow without passage through a pump. The injection rate and the dilution air flow determine the dilution ratio. This air supplies the DustTrak particle analyzer which continuously measures particle mass concentration, and three filter samplers connected in parallel. Two of the filters (47 mm stretched Teflon) collect particle samples for gravimetric mass determination which provides a direct calibration of the DustTrak. They are also analysed for ion composition and levoglucosan concentration. The third filter (47mm quartz-fibre) collects particle samples for organic and elemental carbon determination.

The gas sample stream is drawn through ¼" Teflon tubing and filtered before passing to the sensors. During field-testing it was found that the primary dilution was not always sufficient to bring the flue gas concentration within both CO and CO₂ sensor range, and therefore a secondary dilution step was also added to this stream.

The filters used to protect pumps and sensors from particle contamination comprise a pre-filter consisting of a gas drying tube packed with glass wool, and a 47mm diameter 1µm Teflon filter (Fluopore, Millipore). The pre-filter removes most of the particle mass extending the life of the Teflon filter to more than 10 days which is the maximum period for which a household was tested.

Flow rates of all supply-air and sample streams are monitored by mass flow meters; some of the flows are also controlled. Temperatures of all the airstreams, the analyzer housing and the gas detector enclosure are also recorded. Data is logged at 1 second intervals then reduced to 1-minute averages. Both 1-second and 1-minute data are saved to file. The analysis unit is shown in Figure 3-6.

3.4 Household Selection

The selection of households for the field study was determined largely by practical considerations. The measurement programme involves some disruption for householders to their normal activities and therefore limited the pool of volunteers who were interested in the scientific issues, and tolerant of experimental programs. They needed to be available for an hour or more during the day the equipment was installed, and during operation they were requested to maintain a detailed diary of heater operation and fuel use. And because we were using new instrumentation and protocols that, although tested, had not been proved in routine field operation, there was a significant probability that we would need to conduct modifications or repairs on site. Safety was another issue. It was important that the woodheater flues could be accessed safely by the team of plumbers who assisted with the installation and removal of the equipment. And finally, to minimise sampling losses, it was important that the distance from the flue to the monitoring equipment on the ground was less than 15m.

With these issues in mind, we initially approached the households who had participated in the Launceston Indoor Air Quality Study (Galbally et al., 2004) which was undertaken by CMAR in 2003 because they had some experience of working with the CSIRO team. This was supplemented by respondents to a local campaign for volunteers conducted by the Launceston City Council and ABC regional radio. Approximately 25 householders volunteered. Their residences were distributed throughout the Launceston air-shed. This process may introduce some bias compared with the total population of wood-heaters in Launceston because volunteers may be more interested in heater performance and more aware of the correct operating practices than the wider population. However the benefits of working with cooperative and interested owners ensured a high probability of operational success, which outweighed the risks from sampling bias.

In total, 22 field tests were conducted on 17 houses, with 4 houses being tested twice. One test failed totally because power to the equipment was accidentally turned off soon after the equipment was installed, and one test partially failed because an air line to the flue sampler was accidentally crimped during installation. The households tested covered a full range of heater use patterns. This included houses where (a) the heaters were used only in the evening and occasionally on the weekends, (b) households where both residents worked during the day and heaters were used only in the early evening during weekdays, but were used almost continuously on weekends, (c) households where residents worked from home and heaters were used heavily on weekdays, but not on weekends and (d) households where heaters were used almost continuously. The household heater usage patterns and daily fuel use are listed in Table 1.

Table 1 Households tested in the study and their average daily fuel use during the week and on the weekends.

Test	House	Heater	Flue type	Start	End	Weekday		Weekend		Daily fuel use (kg)	
						Day use	Hours ¹	Day use	Hours ¹	Weekday	Weekend
1	1	Rayburn Royal	Free standing	26/07/2007	1/08/2007			Y			
2	2	Saxon, Leatherwood	in chimney	4/09/2006	12/09/2006	Y		Y		15.0	18.6
3	3	Saxon	in chimney	12/09/2006	21/09/2006					12.9	14.6
4	2	Saxon, Leatherwood	in chimney	23/05/2007	30/05/2007	Y	13.6	Y	7.9	28.9	21.2
5	4	Saxon, Blackwood	in chimney	31/05/2007	6/06/2007		3.5		5.7	13.6	22.0
6	5	Arrow, 2000	in chimney	31/05/2007	6/06/2007		7.2		6.8	28.2	22.2
7	6	Saxon	in chimney	19/06/2007	27/06/2007		8.8	Y	11.7	30.4	31.6
8	7	Saxon	in chimney	19/06/2007	27/06/2007		3.9		3.5	17.0	20.4
9	8	Saxon, 600 Freestander	Free standing	28/06/2007	9/07/2007	Y	10.6		8.8	29.3	31.1
10	3	Saxon	in chimney	28/06/2007	9/07/2007		4.3		7.2	15.6	16.8
11	9	Saxon	Free standing	11/07/2007	18/07/2007		6.4	Y	4.2	17.0	18.8
12	10	Saxon	Free standing	12/07/2007	18/07/2007		3.4	Y	8.9	9.5	13.5
13	11	Saxon, 600 Freestander	in chimney	18/07/2007	25/07/2007		3.6	Y	6.2	12.4	11.5
14	12	Coonara 2200	in chimney	19/07/2007	25/07/2007		3.3		6.6	16.6	7.3
15	1	Rayburn Royal	Free standing	26/07/2007	1/08/2007		2.1	Y	12.9	9.2	25.3

16	13	Burning Log, Turbo 10 Hi Tec 2000	Free standing	3/08/2007	14/08/2007		6.6		5.6	14.4	9.8
17	14	Coonara, Free standing	Free standing	3/08/2007	14/08/2007	Y	7.7		8.6	17.3	22.7
18	15	Kemp, Jindara	in chimney	15/08/200 7	22/08/2007					12.8	15.4
19	5	Arrow, 2000	in chimney	15/08/200 7	22/08/2007	Y	9.1	Y	13.3	26.0	19.9
20	16	Saxon	in chimney	23/08/200 7	3/09/2007		3.6		4.7	10.9	13.5
21	17	Saxon. Inbuilt	in chimney	23/08/200 7	3/09/2007	Y	14.2	Y	8.8	32.3	15.1

1 Time interval (h) between ignition and final refuelling

3.5 Operating Protocol

All sensors in the equipment were fully calibrated before deployment. Air flow was calibrated against a bubble flow meter (Giliblator-2, Gilian, USA) or a graphite piston flow meter (Drycal DC-Lite, Bio, NJ, USA). The CO₂ sensors were calibrated against known CO₂ concentrations generated by diluting pure CO₂ with Zero-grade air using a dynamic dilution system comprising a pair of mass flow controllers (Brooks 5860i, Brooks Inst, PA, USA). The CO sensor was calibrated against a 500 ppb certified gas mixture (BOC). The DustTrak particle monitor (TSI Instruments, USA) was calibrated against gravimetric measurements of particle mass collected on filters connected in parallel to the particle sample manifold as described above.

Prior to installation the primary diluters were disassembled and cleaned, the gas sample lines were cleaned and flushed and the pressure lines were flushed with dry compressed air. The flue extension was cleaned of any accumulated soot. All Teflon backup filters were checked and where required, replaced. The glass wool in the pre-filters was replaced, and scrubbers and driers were checked. All water traps were drained. And finally the system was then checked for leakage.

At the installation site, a checklist involving measurement of all sample flows, sensor voltages and sensor operation was completed. Two pre-weighed stretched 47 mm Teflo filters (Pall R2PJ047, 2 µm pore size) were loaded into holders and fitted to ports on the particle sample manifold. One 47 mm quartz filter (pre-cleaned by baking at 400°C for 24h) was loaded into a holder and fitted to the third filter port on the manifold to collect samples for EC/OC determination.

NATA-accredited gravimetric mass measurements on the pre-exposed and exposed filters were made in the aerosol mass laboratory (Accreditation Number 245) at the CSIRO Marine and Atmospheric Research Aspendale facility. Gravimetric mass on filters was determined using a Mettler UMT2 ultra-microbalance with a specialty filter pan. Electrostatic charging was reduced by the presence of radioactive static discharge sources within the balance chamber.

On completion of each test the air flows were again measured on-site prior to removal of the sampler.

Householders were interviewed at the start of each test and were requested to complete a diary of daily heater operations and fuel use. Fuel weights were measured using a provided set of digital bathroom scales. The diary and installation check list forms are presented in Appendix A.

3.6 Data analysis

3.6.1 Emission rates

Using Equation 1, emission rates are calculated from the concentration of the pollutant in the flue gas and the flue gas flow rate, both of which are measured directly using the sampler.

3.6.2 Emission factors

In most standard tests (such as AS/NZ 4013) the emission factor for a trace species (EF_i) is calculated from E_i , the total mass of tracer emitted during complete combustion of the fuel mass (M) i.e.

$$EF_i = \sum E_i / M, \quad (2)$$

In these tests, fuel is loaded into the heater, ignited and allowed to burn to completion. The timecourse of emission varies between trace species and combustion condition. Volatile organics and particulates generally are emitted during the pyrolysis phase early in the burn cycle, not during char combustion which occurs in the later stage of the cycle. In contrast CO_2 and CO are emitted during both stages of the combustion cycle. Over a complete combustion cycle, However, the timecourse of emission is not relevant to Equation 2.

In the real world this pattern of combustion does not commonly occur. Normally, fuel is added progressively to the fire, and therefore at any moment the fire is composed of a mixture of fuel mass at different stages of combustion. Equation 2 is not relevant to this situation and emission factors are calculated using the dual tracer approach developed for open combustion studies. It is described in detail in the review by Andreae and Merlet (2001). In this, the emission rate of the tracer (E_i) is defined as

$$E_i = E_c \times \frac{C_i}{\sum C},$$

where C_i is the concentration of species i in the smoke, $\sum C$ is the concentration of all carbon species; (CO_2 , CO , CH_4 , VOC and total particulate carbon but it can be approximated to CO_2 and CO without excessive loss of precision) and

$$E_c = CC \times \frac{dM}{dt},$$

where CC is the fuel carbon content, dM/dt is the rate of fuel consumption. CC for most fuels is very close to 0.5.

Hence EF_i calculated using the dual tracer method is the instantaneous ratio of the emission rate to the fuel consumption rate

$$EF_i = \frac{E_i}{E_c} \times CC = \frac{C_i}{\sum C} \times CC, \quad (3)$$

The difference between these approaches is that equation 3 relates the emission of the trace species to the rate of fuel combustion while equation 2 relates emission to the the rate of fuel loading. For the two approaches to be comparable equation 3 should be integrated over the duration of the fire, or a day, depending on which is longer. If sampling is intermittent, integration over the full duration of the fire is impossible and the result can be biased by the sampling frequency. Sampling, therefore, should be continuous. However for atmospheric dispersion modelling, equation 3 can usefully be integrated over shorter durations such as an hour where it can be combined with recorded rates of fuel use to estimate emission rate.

In this study emission factors are always calculated using Equation 3 and emission rates are calculated using Equation 1. In neither case is it necessary to know the mass of fuel burned. The fuel consumption data however provides a useful independent test of the accuracy of the emission measurements.

In summary, Equations 2 and 3 are conceptually quite different. Equation 2 describes the potential emission of PM10 from a mass of fuel burned to completion. Equation 3 describes the rate of PM10 emission relative to the instantaneous rate of fuel combustion at any stage in combustion cycle. The two definitions are equivalent only when Equation 3 is integrated over the complete test cycle and, therefore, direct comparison of EF defined by Equation 3 with the AS/NZ 4013 compliance objective is not valid for periods less than a full fire cycle.

3.6.3 Sensible heat emission

The heat released by combustion can also be considered in the context of emissions to be a tracer. Total enthalpy (i.e. heat) comprises sensible and latent heat. Latent heat (i.e. the energy embodied in water vapour) was not measured in this study. The rate of sensible (heat emitted in the smoke (H)) can be calculated from the flow rate of flue gas (F , $\text{m}^3 \text{min}^{-1}$), the absolute gas temperature (T , $^{\circ}\text{K}$), the density of the gas at T (D kg m^{-3}), and the heat capacity of the smoke (C_p , J (kg.K)^{-1}) at T ,
i.e .

$$H = F \times D \times C_p \times T \quad (4)$$

Flue gas flow rate (F) was calculated from the pressure difference across the orifice plate (P , Pa) either using the calibration against the Annubar flow meter,

$$F = -0.5474\sqrt{P} \quad (5)$$

or from an empirical approximation of the flow formulae for the dimensions and operating temperatures of the flue, and orifice plate dimensions. Flow rates at a range of temperature and pressure differentials were predicted using standard formulae. These data were then reduced to the regression equation,

$$F = (0.4109 + 6.85 \times 10^{-4} \times T + 2.96 \times 10^{-7} \times T^2) \times \sqrt{P} \quad (6)$$

This approximation was effective for the full range of pressures and flows measured in the experiment with accuracy better than 1%

3.6.4 Flue gas concentrations

Gas and particle concentrations were measured following two stages of dilution. The first dilution occurred in the primary diluter on the flue sampler and was common to both particle and gas sample lines. The primary dilution ratio (DR_1) applies to all trace species measured (PM10, CO_2 and CO). The gas and particle samples were each further diluted to bring the concentrations in the operating range of the sensors. The particle and gas dilution ratios (DR_p and DR_g) apply respectively to PM10 and to CO and CO_2

Hence the concentration of PM10 in the flue gas (F_{PM10}) is calculated from the concentration measured by the DustTrack (DT_{PM10}) as:

$$F_{PM10} = DT_{PM10} \times DR_1 \times DR_p \quad (7)$$

Concentrations of CO_2 and CO in the flue (F_{CO} and F_{CO_2}) are calculated from the measured concentrations multiplied by the combined primary and secondary dilution ratios, $DR_1 * DR_g$.

Because the primary dilution applies equally to PM10 and to CO and CO_2 , the PM10 emission factor (EF_{PM10}) is independent of DR_1 i.e from Equation 3

$$EF_{PM10} = \frac{(DR_p \times DT_{PM10})}{(DR_g \times (CO_2 + CO))} \quad (8)$$

This means that emission ratio estimates remain accurate in the event that the primary diluter gradually becomes blocked by tar deposits causing DR_1 to vary.

4 *IN SITU* MEASUREMENT OF WOODHEATER EMISSIONS

4.1 Sampler performance

For the most part, the samplers performed reliably. Figure 1-1 shows a typical emissions profile for a wood stove used as the main cooker mostly in the afternoon on weekdays (e.g. day 208), and in the afternoon and early evening on the weekend (e.g. day 209). This heater was operated with the damper mostly open. This stove is also fitted with a boiler and therefore loses less heat to the atmosphere than a woodheater, which is evident in the relatively low flue temperatures. In most cases following ignition, the heater door is kept open while the fire develops in intensity. The air flow and accompanying emissions increase to a peak until the door is closed, reducing the air flow and with it the rate of combustion. The event is observed in the temperature time series as a sudden decline in flue gas temperature. PM10 emissions are at maximum in this early stage of combustion which is dominated by pyrolysis. Once the fire is established the PM10 emissions decline. The emissions continue at slowly declining rate until more fuel is added, when further pyrolysis and PM10 emissions occur. The pattern continues until the late evening when the fire is allowed to burn out. PM10 emission occurs throughout the period of use, although often at a very low rate. All emission have ceased soon after midnight with the death of the fire.

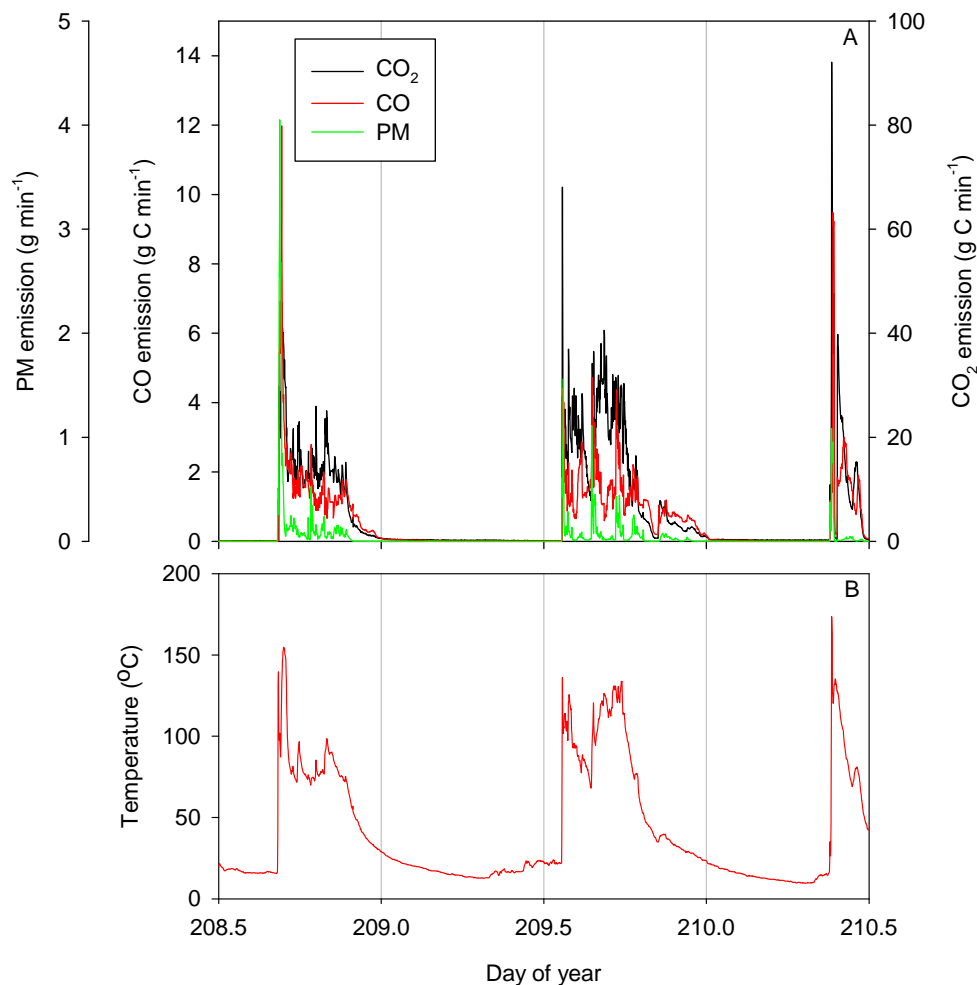

Figure 4-1 Test 15. Timecourse of A. PM, CO₂ and CO emissions and B. temperature of the flue gases at the exit to the flue.

Figure 4-1 is an example of good sampler performance. However there were other occasions when performance was marginal, mostly associated with primary diluter problems. These were the result of blockages of which there were two distinct classes. The first was caused from tarry deposits forming in the sample tube eventually restricting or stopping flow. The symptom was a progressive decline in apparent gas and PM10 concentration. It was observed on a few occasions at the end of the testing period and generally followed extended heater use with closed dampers. This resulted in errors in the emission estimates, but, because it affects gases and PM10 equally, the EF estimates remain accurate so long as some flow continued. The problem was relatively uncommon, and short of removing and cleaning the diluter, there was little that could be done to rectify it during household testing.

Intermittent blockages were more of an issue. These are probably caused by condensation forming in the venturi completely stopping sample flow until either the condensate evaporated or drained. Once cleared, normal sampling resumed. The intermittent blockages resulted in

temporary but complete loss of tracer concentration data and significantly reduced the effective data capture for some tests. An example of this fault is shown in **Error! Reference source not found.** The blockages are identified by a sudden decline in measured CO₂ or PM10 concentration to ambient levels and an equally rapid return to normal values following clearing of the blockage.

Fortunately, the data capture rate was sufficient to allow us to determine emission factors and emission rates for all the tests. All other faults were relatively minor and were largely rectified during the campaign.

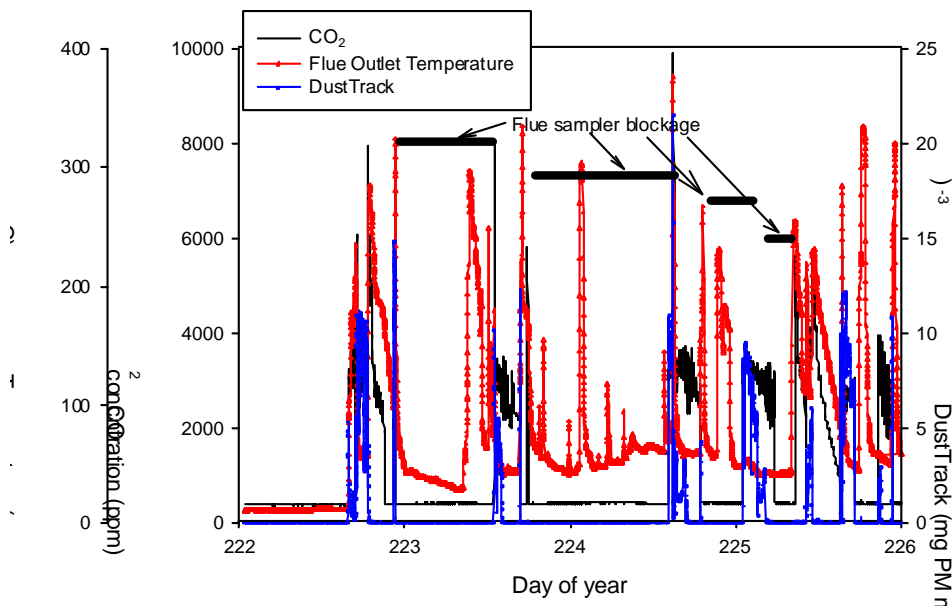

Figure 4-2 An example of intermittent blockages in the venturi of the primary diluter. The temperature timecourse indicates the combustion rate. Test 17

4.2 Household woodheater usage patterns

One of the objectives of this study was to determine the pattern of household heater use. The most accurate measure of this is the rate of fuel consumption measured as the emission of CO₂ and CO, however when intermittent blockages reduce the accuracy of the emission estimates, the temperature and flow timecourses provide a reliable alternative measure of the usage pattern. The following figures present the range of common patterns of use.

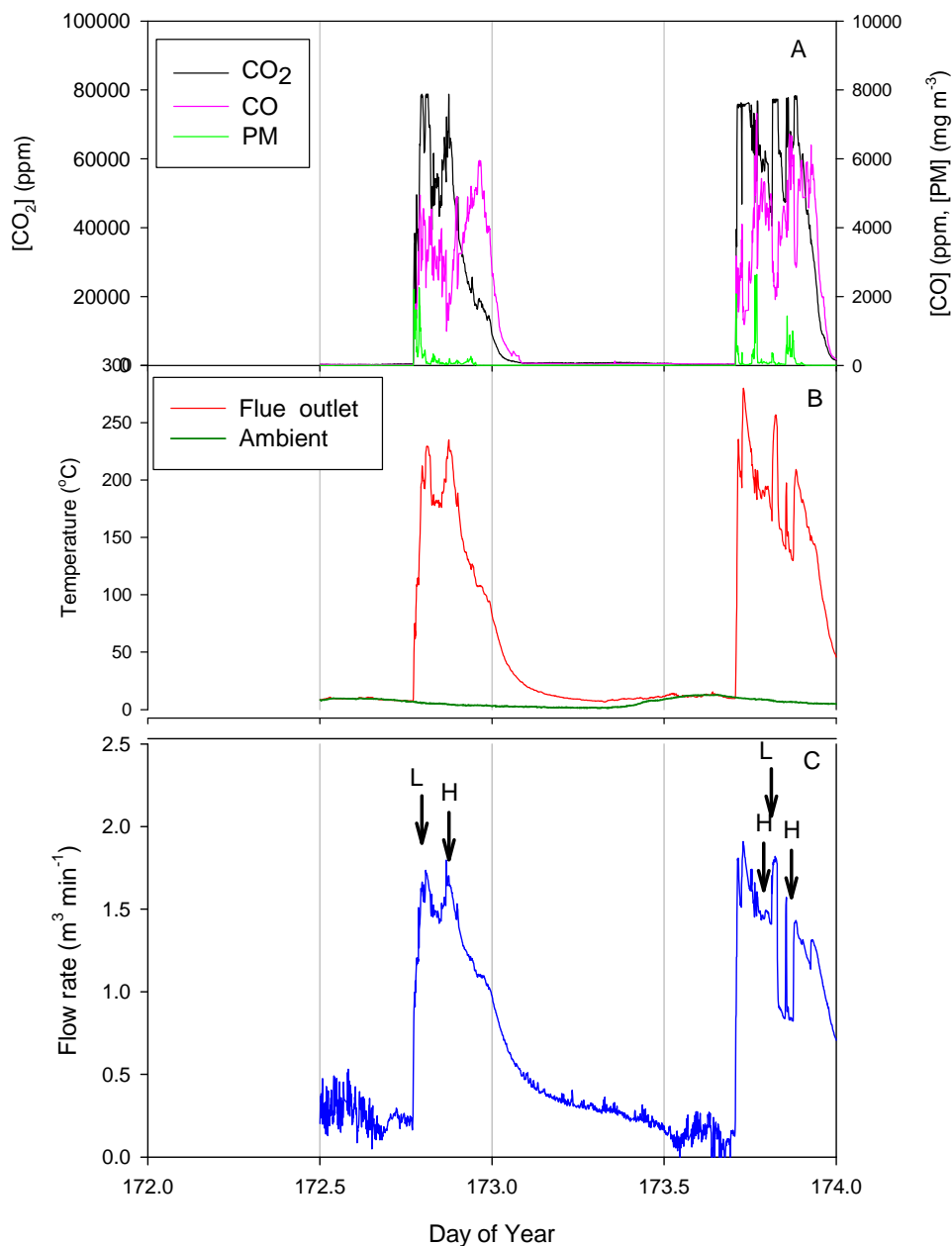

Figure 4-3 Test 8. Timecourse of a heater used mostly for evening use on both weekdays and weekends. A. Flue concentrations of PM, CO_2 and CO, B: ambient and flue temperature, C: flow rate of flue gases. Arrows indicate changes in damper setting

Figure 4-3 shows an example of heater performance in a household where the heater is used primarily in the early evening during weekdays and slightly later on weekends. In this example the heater was loaded only at ignition on the first day (day 172) and reloaded only once on the second day; a pattern which is very similar to an AS/NZ 4013 test. PM10 emissions occurred only during pyrolysis. Concentrations of both CO and CO_2 are very high in flue gas peaking at 600 ppm and 80,000 ppm respectively. On day 172 the fire progresses from pyrolysis to char combustion which is characterised by an increase in CO concentration without an

accompanying increase in PM10 concentration. The rate of char combustion accelerated when the damper was opened. This event appears in the timeseries as a step change in flow rate (Figure 4-3A)

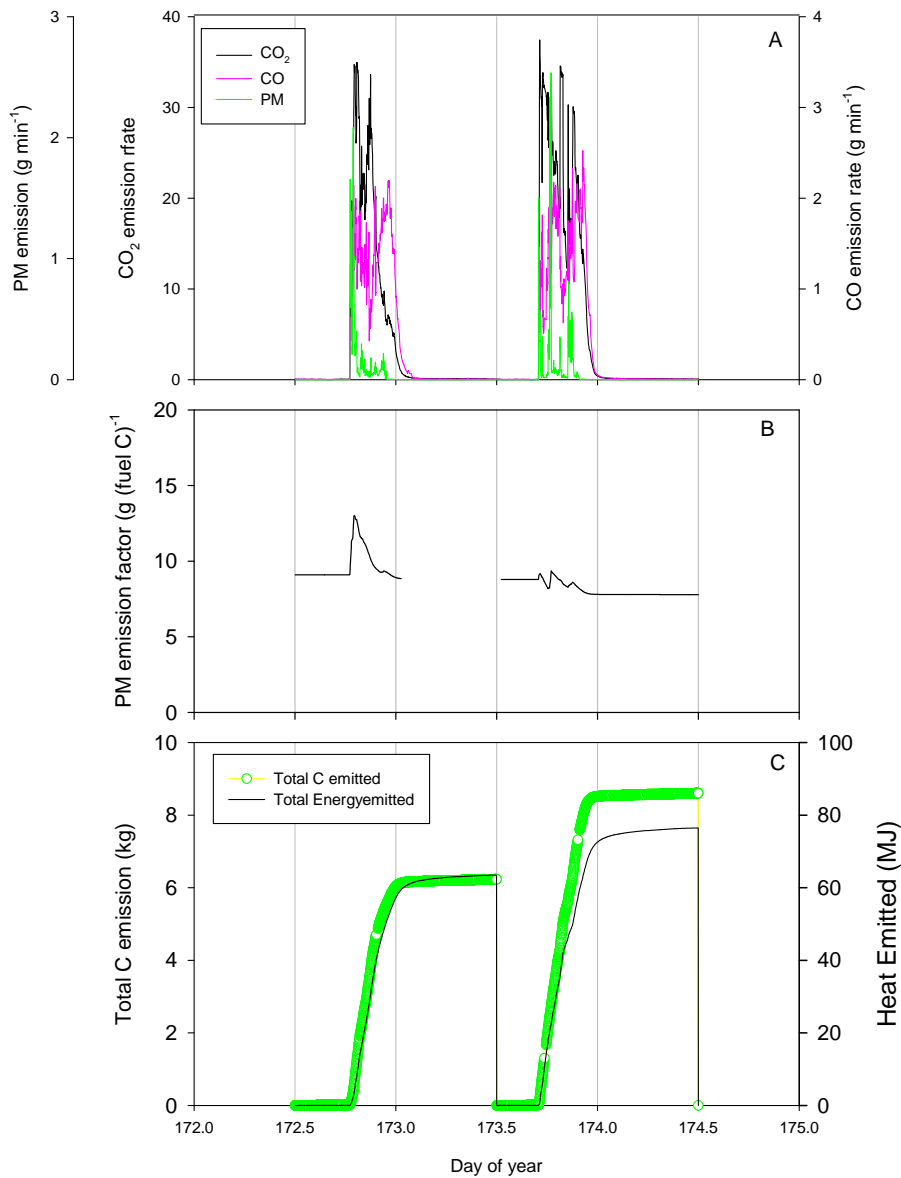

Figure 4-4 Test 8. Timecourse of a heater used mostly for evening use on both weekdays and weekends. A. PM, CO₂ and CO emission rate B: daily PM10-EF, C: Cumulative total C and heat emitted.

Error! Reference source not found. Figure 4-4 shows the timecourse of emissions, PM10-EF, total sensible heat emission and total carbon emission accumulated through the course of the day. PM10 emissions ceased toward the end of the evening although CO₂ and CO emission continued into the early part of the following day. The cumulative PM10 emission factors were approximately 10 g PM per kg fuel C which is equivalent to 5 g PM per g kg fuel on both days. This is close to the 4013 compliance standard.

Sensible heat emitted by the flue gas is (ideally) a small proportion of the heat released by combustion. Approximately 12% of the total heat produced is latent heat and heaters are typically 40-60% efficient, therefore from 28-48% of the heat released by combustion will enter the flue as sensible heat. A further substantial fraction will be lost through the walls of Total carbon emission rate can also be used to estimate heat release by combustion. In this example (Figure 4-5 **Error! Reference source not found.**C) sensible heat emitted from the flue accounted for approximately 25% of the heat generated by combustion.

An example of overnight operation on a weekend is presented in Figure 4-5. In this case closed dampers and continued refuelling caused PM10 emission to continue through the night.

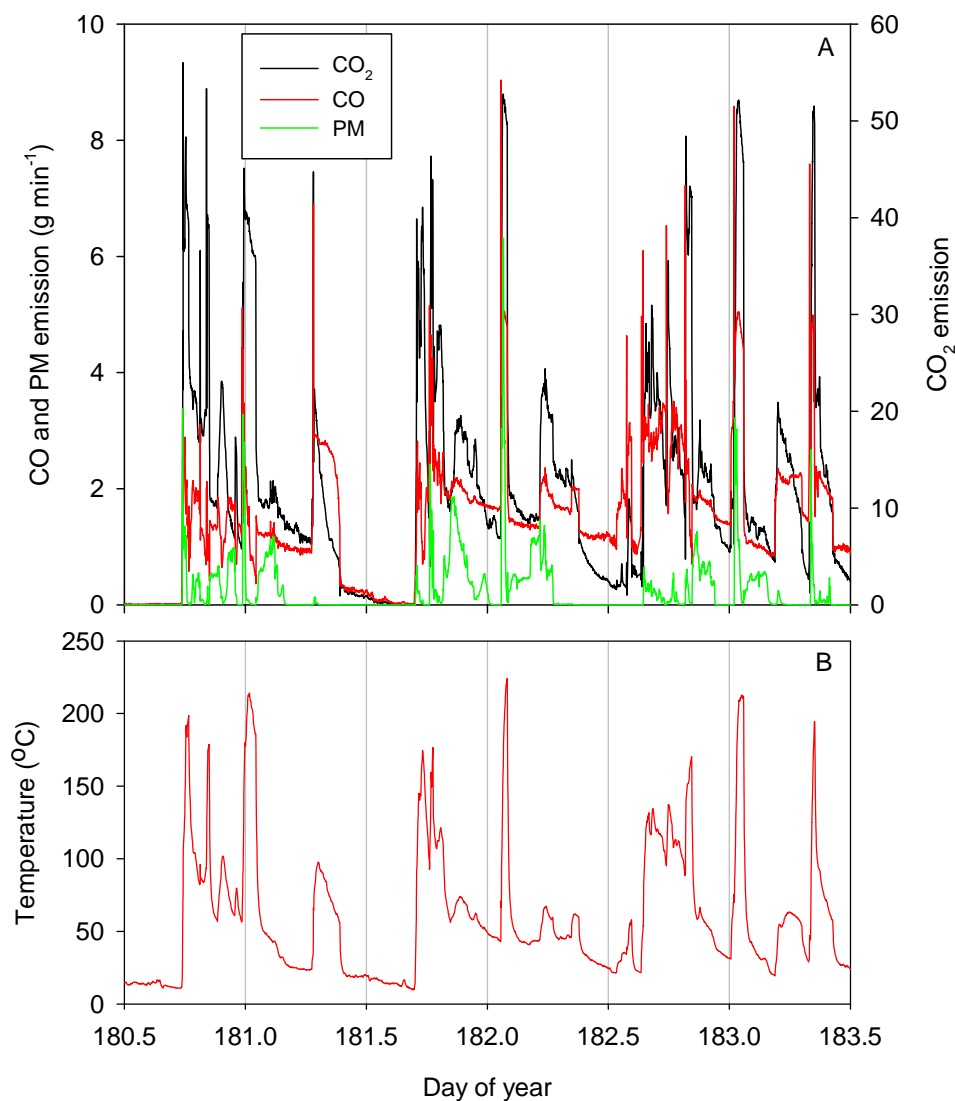

Figure 4-5 Test 9. Timecourse of A. PM, CO₂ and CO emission and B. temperature from a heater used extensively on a weekend.

A similar pattern is observed when heaters are used primarily for weekday operation by people who work from home. Figure 4-6 shows the PM10 emissions that occur when the dampers are fully shut for extended periods. The heater was refuelled throughout the day maintaining a steady rate of pyrolysis and PM10 emissions.

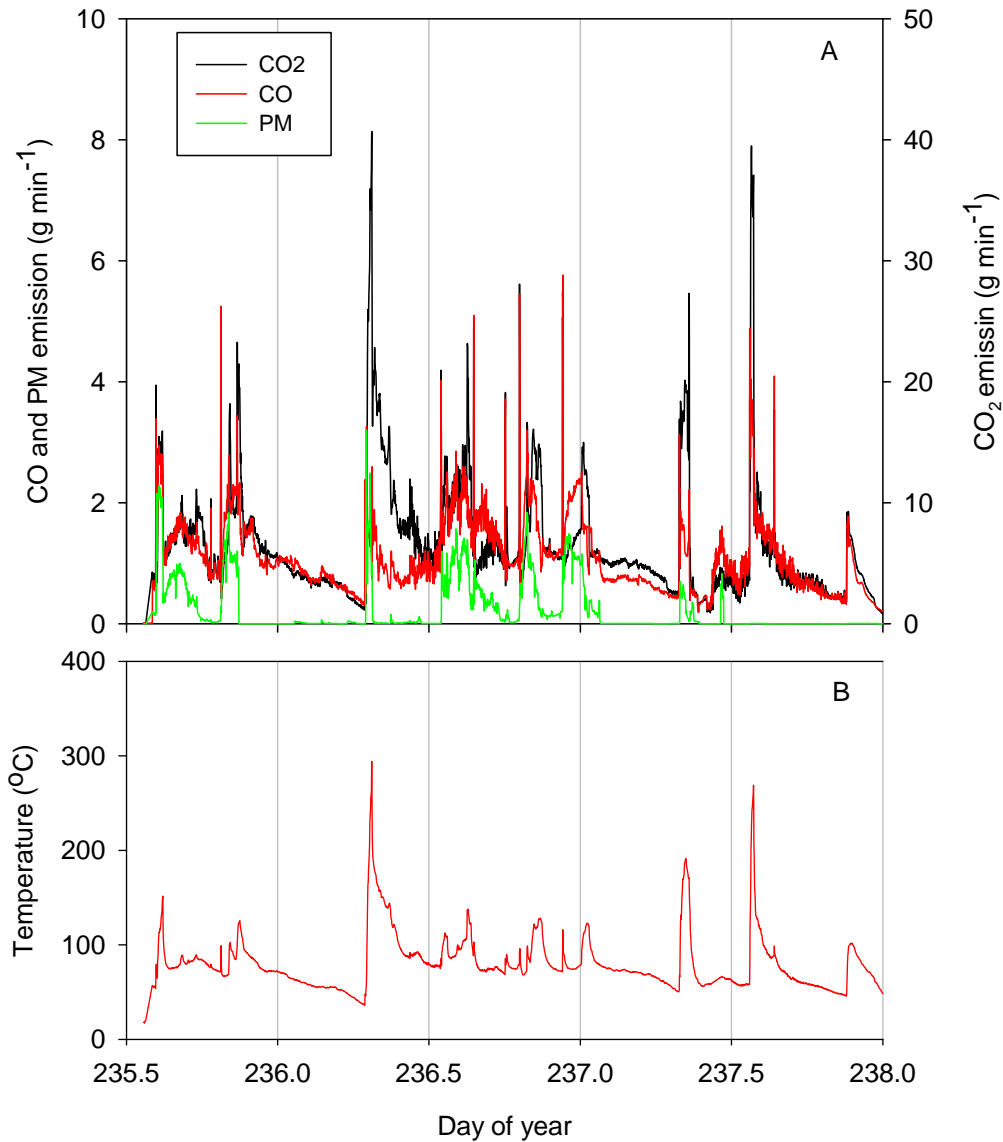

Figure 4-6 Test 21. Timecourse of A PM10, CO₂ and CO emissions and B, flue gas temperature from a during daytime operation during the week

Finally, an example of a change from weekday use (day 230, Thursday) to weekend use is shown in Figure 4-7. On Thursday (day 229) the fire is allowed to burn out in the late evening, while on Friday the heater is partly reloaded in the late evening for overnight operation. This results in renewed PM10 emissions.

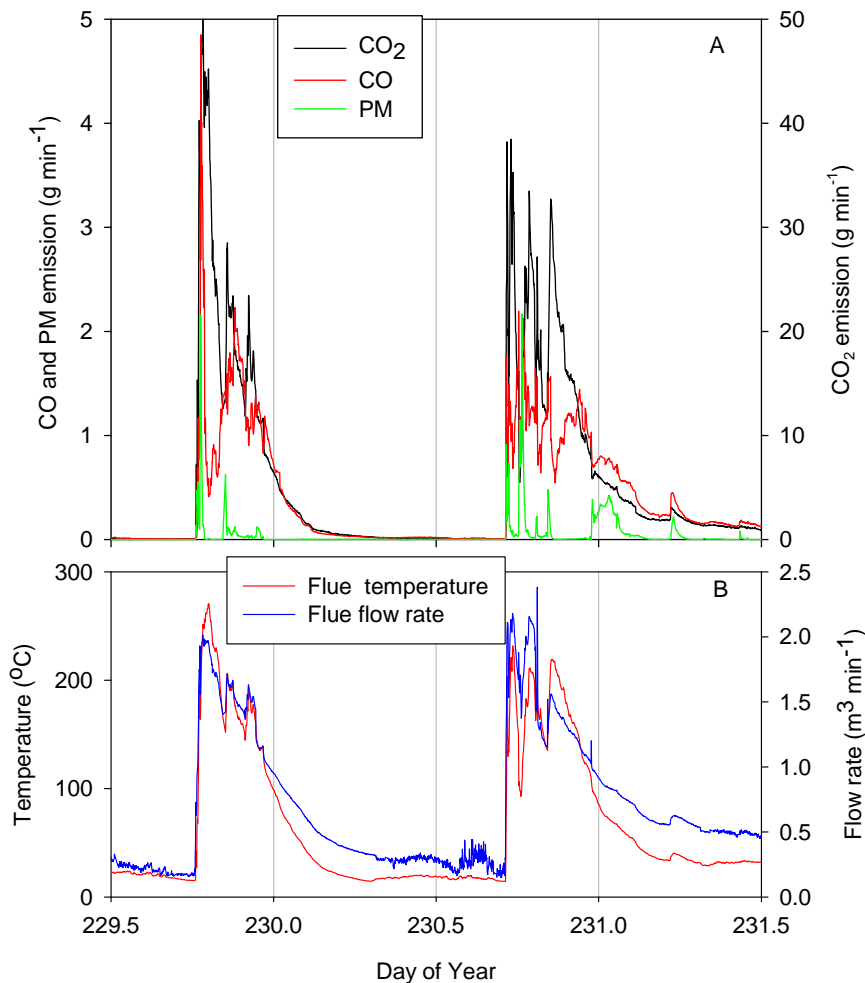

Figure 4-7 Test 19. Timecourse of A: PM, CO₂ and CO emissions, and B: Temperature and flue gas flow rate for a heater operates in the evening on Thursday and Friday.

In order to summarise the diurnal patterns of woodheater use data were first separated into weekdays and weekends. Weekdays comprise 12:00 Monday to 12:00 Saturday and weekends comprise 12:00 Saturday to 12:00 Monday. Average weekday and weekend diurnal profiles were calculated for each household tested, and the results were then averaged across all households. The diurnal profiles of sensible heat, CO₂ emission rate and PM emission rate are presented in Figure 4-8. The weekday and weekend profiles of sensible heat and CO₂ emissions, which best indicate the rate of fuel combustion; differ only in the higher rate of emission during the afternoon. Heat and CO₂ emission should be almost identical in pattern; the slight differences apparent during the day are a measure of the extent of data loss due to the blockages in the primary sampler. Maximum fuel use occurs in the early evening between 6 PM and 9 PM. PM₁₀ emission rates decline through this period increasing to a second peak at midnight then continuing to decline through the early morning

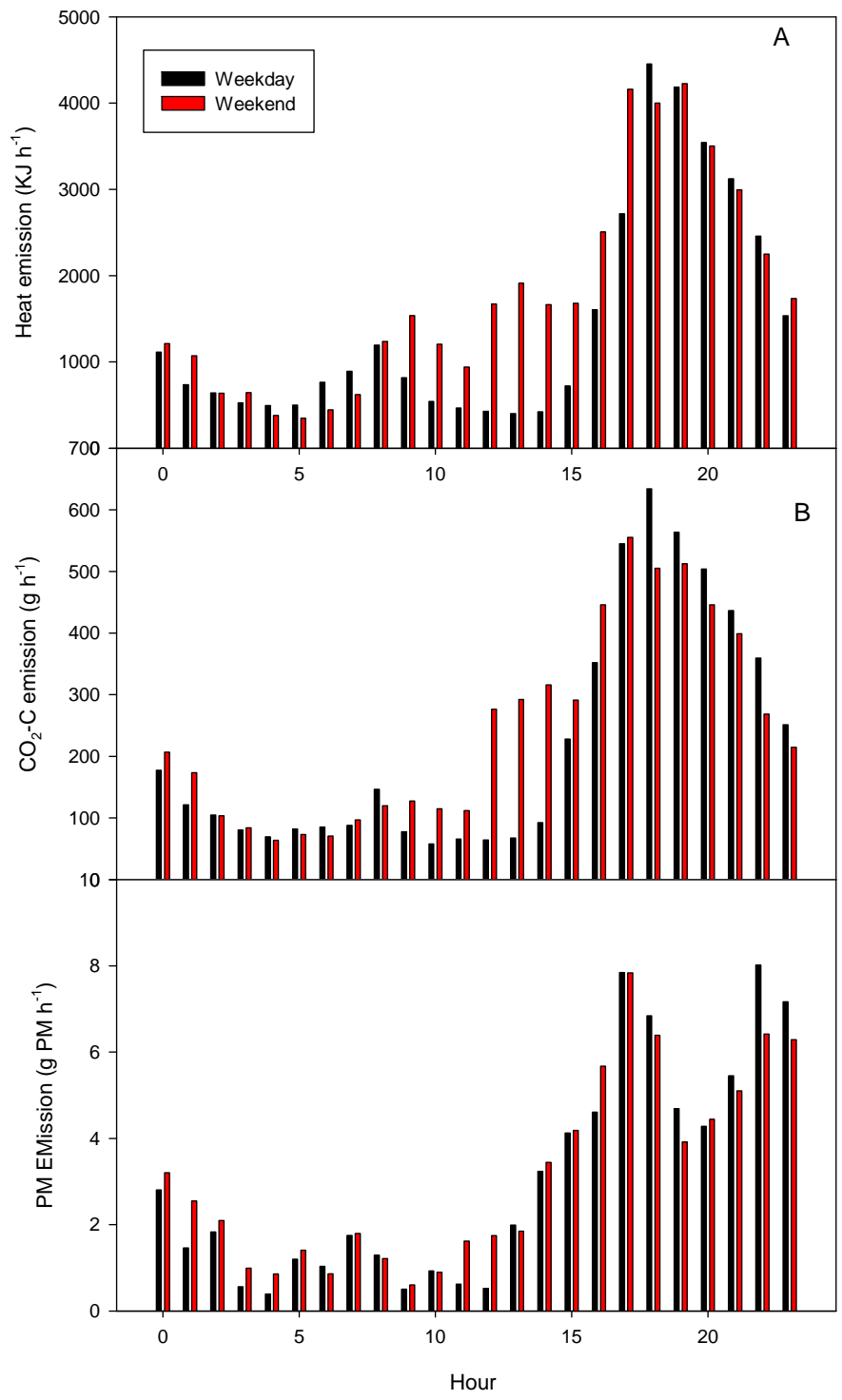

Figure 4-8 Average daily timecourse of emissions from heaters in the Launceston air-shed on weekdays and weekends. Emission of sensible heat, CO₂, and PM10

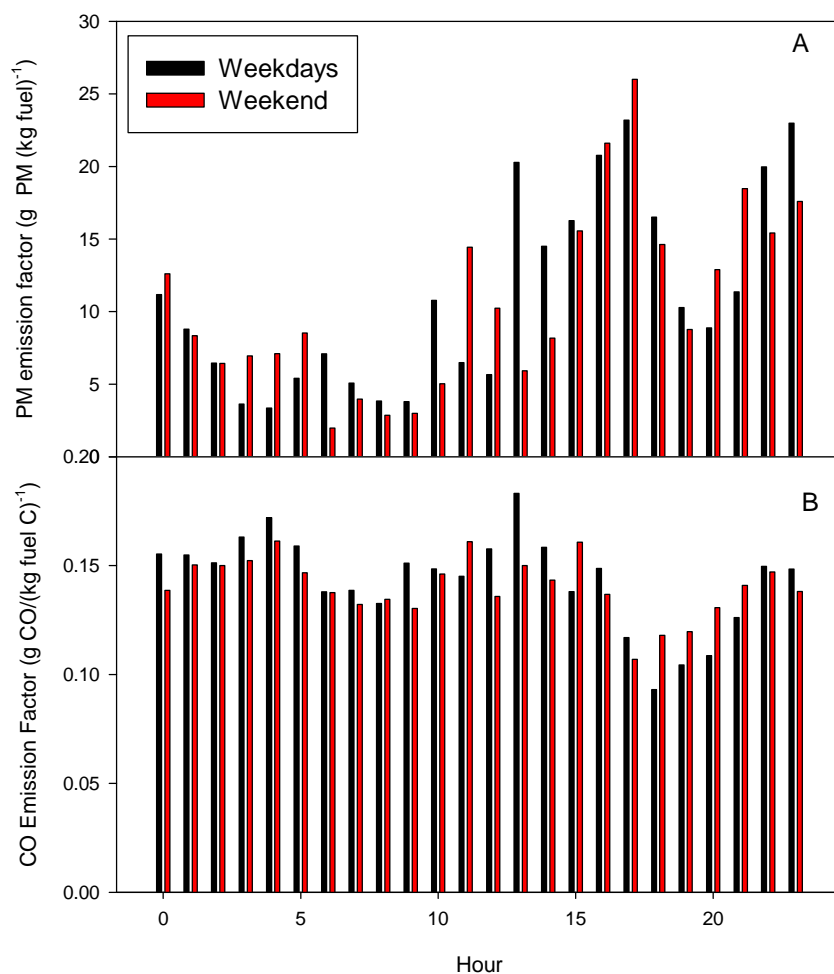

Figure 4-9 Average daily timecourse of emissions from heaters in the Launceston air-shed on weekdays and weekends. A: PM10-EF. B: CO-EF

Hourly PM10-EF, i.e. the rate of emission relative to the rate of fuel consumption, peaks at 25 g PM10 (kg fuel burned)⁻¹ or 2.5% of the fuel mass (Figure 4-9). This peak corresponds to the pyrolysis phase of combustion, and, once the volatile components of the fuel have been emitted to leave charcoal, the hourly emission factor declines. A second peak of PM10 emission occurs late in the evening when fires are reloaded and damped down to burn through to the morning. Weekday usage patterns differ from weekend patterns with higher PM10-EFs in the early afternoon on weekdays while on weekend PM10-EFs extend through the late evening into the early morning.

On average approximately 15% of fuel carbon is emitted as CO except in the mid evening during the period when combustion progresses from pyrolysis to char combustion. These are relatively high rates of CO production and indicate that for most of the time combustion is oxygen limited. It shows that woodheaters are generally operated with partly or fully closed dampers except, perhaps, during the early evening.

4.3 Flue temperature, flow rate and emissions.

The air draft through the heater is driven by buoyancy due to the heat generated by the fire and therefore flue gas temperature and flow should be highly correlated. However the gradient of the curve is determined by the resistance of the flow path, the most important component of which is damper setting. A plot of flow rate against temperature reveals how different householders regulate the flow control of their heaters. Low damper settings increase the resistance to airflow and reduce the flow rate for a given temperature. Other parameters also affect flow rate including flue height so it is unlikely that a single relation will apply across all heater installations, however in practice there appears to be a reasonable correspondence from heater to heater. Figure 4-10 shows an example of this. Test 8 and Test 21 each operated their heater at 3 different settings while, Test 15 operated mostly at one setting. Test 21 operated the heater with the dampers closed while Tests 8 and 15 operated with the dampers open. Because air supply affects combustion efficiency it would be expected that the pattern of damper control to be correlated with PM10 emission factor. This is the case for these examples; Test 21 had the 2nd highest average emission factor in this study, while Tests 8 and 15 were respectively within and just above the emission standard.

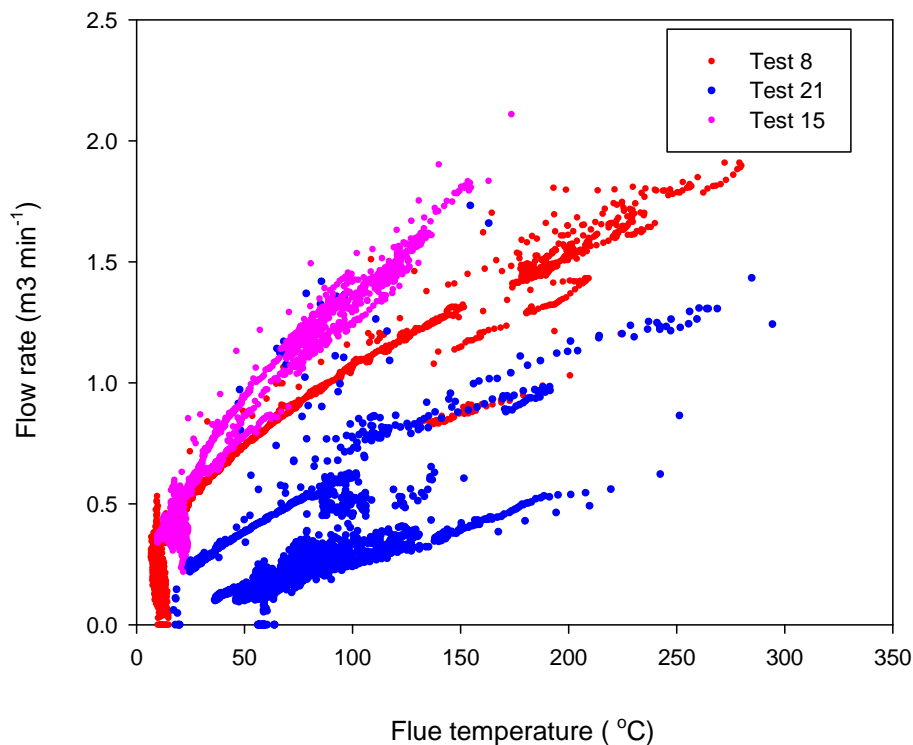

Figure 4-10 The relationship between flow rate of flue gas and flue gas temperature at three houses in Launceston. Blue: Test 21, Red: Test 15; Magenta: house 4. Variations in intercept are correlated with damper setting. Most of the time test 21 had dampers closed. The PM emissions ranked 2nd highest.

4.4 Particle emission chemistry

4.4.1 Chemical tracers for woodsmoke

Biomass burning in Australia plays a central role in atmospheric chemistry. It takes the form of unplanned fires (bushfires) prescribed burning for bushfire prevention and management, domestic wood-fires for home heating, which is prevalent during winter in areas such as Tasmania, Victoria, and the Australian Capital Territory, and industrial biomass furnaces for energy production. A large range of chemicals, both as gases and particulate matter, are emitted during biomass burning. Gaseous species include carbon dioxide, carbon monoxide and hydrocarbons (Andreae and Merlet, 2001) and a large range of trace gases (Andreae and Merlet, 2001; Hurst et al., 1994). Particulate matter includes elemental carbon and organic carbon that is comprised of a vast range of specific organic compounds (Simoneit et al., 1999).

It is important to determine the contribution that smoke from biomass burning makes to the aerosol load, especially in urban areas that have several other sources of particulate matter. This can be achieved by using a particulate tracer species that is emitted exclusively in smoke from biomass burning. Several potential tracers have been investigated; non sea salt potassium (nssK^+), is routinely used and C^{14} proved useful for demonstrating that combustion of recent fuels contributed almost all the non-carbonate carbon in aerosol polluting the Launceston airshed (Jordan et al., 2006a). More recently, another potential tracer, levoglucosan, has been investigated (Jordan et al., 2006b) and found to be particularly promising.

Wood is composed of biopolymers consisting of 40% - 50% cellulose, 20% - 30% hemicellulose and 20% - 30% lignins (Simoneit et al., 1999). During wood burning cellulose is decomposed by one of two major pathways and these have been extensively summarised (Pictet and Sarasin, 1918; Shafizadeh, 1984; Richards et al., 1983). The first pathway occurs at temperatures less than 300 °C and leads to char formation by depolymerisation and water elimination (Simoneit et al., 1999). The second pathway occurs at temperatures above 300° C and the resulting series of chemical reactions lead to the production of anhydro sugars, such as levoglucosan (Simoneit et al., 1999). Figure 4-11 shows the chemical reactions that lead to the production of levoglucosan, and minor species such as galactosan and mannosan, during decomposition of cellulose and hemi-cellulose, at temperatures greater than 300° C.

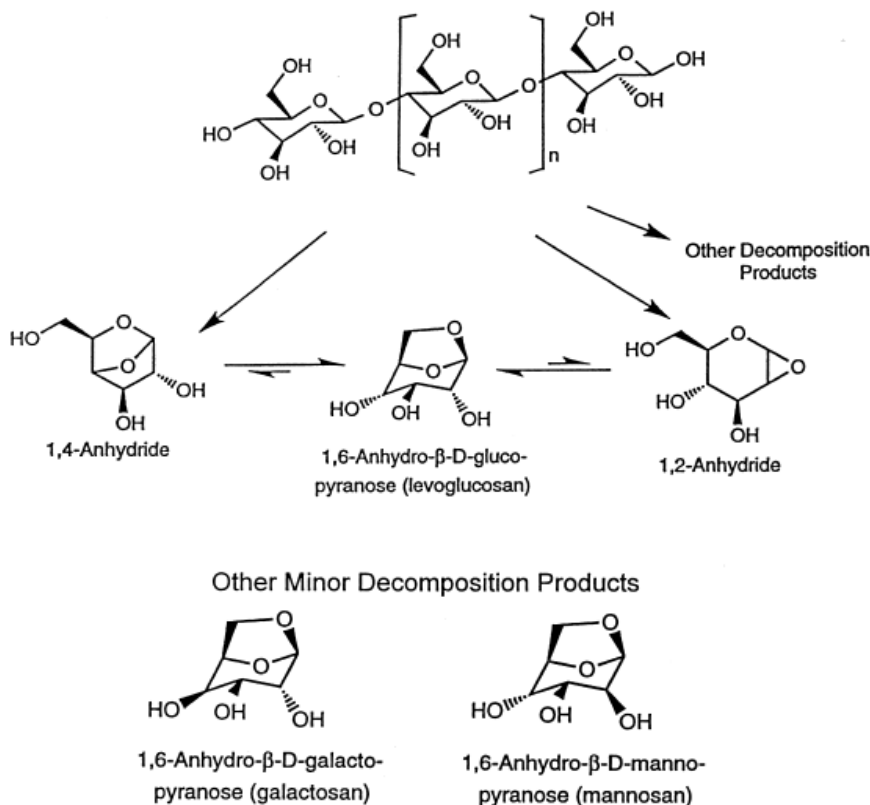

Figure 4-11 Major chemical species produced during decomposition of cellulose and hemicellulose at temperatures greater than 300°C (Elias et al., 2001).

Since high concentrations of levoglucosan are produced in smoke it has been used as a tracer for particulate emissions from fires (Simoneit et al., 1999; Yttri et al, 1985; Dye and Yttri, 2005). One distinct advantage of levoglucosan is that it is a unique tracer for wood burning; it is not produced from any other known source. A second advantage is that levoglucosan is stable in the atmosphere; Fraser and Lakshmanan (2000) report that no degradation of levoglucosan occurred over a period of at least 10 days. Other tracers for woodsmoke emissions have been suggested, but these usually suffer from having more than one source. Potassium for example, is present in wood, and is emitted as fine particles during combustion, but it also has a significant source from sea-salt, and this confounds the apportionment of sources.

The measurement of levoglucosan in particulate samples can be achieved using various analytical techniques, each of which has advantages and disadvantages. One common analytical procedure includes extraction of the filter material with organic solvents, concentration by evaporation, derivitisation, usually with trimethylsilane (TMS) (Hsu Ching-Lin et al., 2007) and analysis by gas chromatography/mass spectrometry (GC/MS) (Simoneit et al., 1999; Bin Abas et al., 2004; Simpson et al., 2004; Pashynska et al., 2002). Levoglucosan can also be measured by high performance liquid chromatography with a mass spectrometer (HPLC/MS) after filter samples are extracted with an organic solvent (Dye and Yttri, 2005; Saarikoski et al., 2007). Although both GC/MS and HPLC/MS provide low detection limits (Dixon and Baltzell 2006), they appear to return low levoglucosan concentrations compared to

techniques such as high performance anion exchange chromatography with pulsed amperometric detection (HPAEC/PAD) (Engling et al., 2006). This may be due to the more complicated extraction and preparation procedures that are necessary to concentrate levoglucosan into an organic solvent.

Since both levoglucosan and potassium can potentially be used as smoke tracers it might be expected that they would be highly correlated with each other. This study measured levoglucosan and ion concentrations of PM10 aerosol masses collected from 16 woodheaters that were operated under typical conditions, over weekly periods in Launceston, during winter 2007 (Table 2) and found that the correlation between potassium and levoglucosan is quite low (Figure 4-12); the correlation coefficient of 0.20 is not significant at the 90% confidence level.

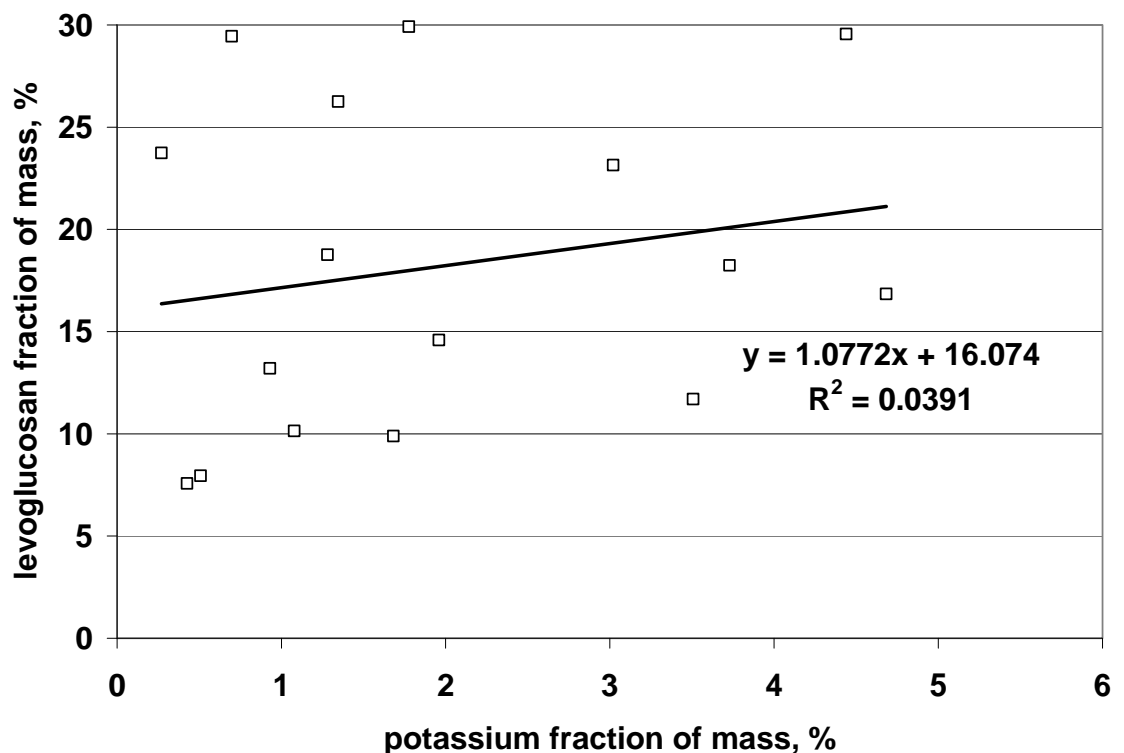

Figure 4-12 Relationship between levoglucosan mass fraction and potassium mass fraction in samples collected from 16 woodheaters in Launceston.

There may be several reasons for the lack of correlation between the two potential chemical markers for woodsmoke. One basic difference between the potassium and levoglucosan fraction of the PM10 mass is the mechanism leading to production of these species in the particulate matter. Potassium exists in the fuel as a minor component of wood and is emitted in the particulate matter during burning. Little is known about the mass balance of potassium during burning, and after burning is complete. It is quite probable that a large fraction of the total potassium in the fuel remains in the ash and unburned carbon residues. The corollary is that only a small, but perhaps highly variable, fraction of the potassium is emitted with

particulate matter in the smoke. Another variable, for which no data is immediately available, is the potassium fraction in the fuel. A range of fuel types are used in woodheaters, and these may have potassium mass fractions which are quite variable. Any variability could be due to the age of the fuel and the fuel types. Potassium mass fractions may be higher in growing trees, or in parts of the tree which are still growing, and lower in trees that are in the senescence phase of their lifecycle.

In contrast to potassium, levoglucosan is produced by a series of chemical reaction which are outlined in Figure 4-11. Although the reactions leading to levoglucosan production occur at temperatures above 300°C, the efficiency of production may not be at a maximum until temperatures of significantly above 300°C are reached in the woodheater. Flame and fuel bed temperatures during rapid pyrolysis are generally well above this threshold.

4.4.2 Estimation of PM10 in the Launceston air-shed contributed by woodheaters

For a tracer to be quantitative it is necessary that it comprises a stable fraction of the total particulate mass generated by combustion, or that variation in the mass fraction can be parameterised in terms of measurable combustion determinants such as combustion efficiency. Jordan and Seen (2005) demonstrated using material collected during AS/NZ 4013 tests that levoglucosan content appeared to be independent of air supply, it did vary between heaters and fuel type. One of the aims of this study was to extend their work to in-service woodheaters that are operated in a wide range of modes, with different fuels.

Table 2 shows the sampling periods and the levoglucosan, mannosan and potassium mass fractions of PM10 emitted from 16 woodheaters in Launceston. The PM10 mass fractions of levoglucosan vary from about 7.5 % to 30% probably due to the burning conditions in the individual woodheater, as discussed above. Mass fractions of mannosan and potassium in the same samples were significantly lower than levoglucosan, and ranged from 0.41% to 1.36%, and 0.51% to 4.68% respectively. The average levoglucosan fraction of the PM10 mass 18.2%, or 182 mg g⁻¹ PM10. This is quite similar to a previously measured emission factor of 140 mg g⁻¹ PM10 for Launceston (Jordan and Seen, 2005).

Table 2 PM10 mass fractions of levoglucosan, mannosan and potassium found in particulate collected from 16 woodheaters in Launceston.

Start date	End date	Levoglucosan % of PM10 mass	Mannosan % of PM10 mass	Potassium % of PM10 mass
23/05/2007	30/05/2007	26.25	0.13	1.35
31/05/2007	6/06/2007	29.91	1.36	1.78
31/05/2007	6/06/2007	29.45	1.34	0.7
19/06/2007	27/06/2007	29.56	1.06	4.44
19/06/2007	27/06/2007	9.89	0.68	1.68
27/06/2007	9/07/2007	10.14	0.44	1.08
27/06/2007	9/07/2007	13.2	0.55	0.93
11/07/2007	18/07/2007	23.14	1.2	3.02
11/07/2007	18/07/2007	23.74	0.75	0.27
18/07/2007	25/07/2007	18.24	0.48	3.73
19/07/2007	25/07/2007	14.59	0.29	1.96
3/08/2007	14/08/2007	16.84	0.57	4.68
3/08/2007	14/08/2007	7.57	0.37	0.43
15/08/2007	22/08/2007	11.7	0.65	3.51
15/08/2007	22/08/2007	18.75	0.66	1.28
23/08/2007	3/09/2007	7.95	0.41	0.51

If we select only those data from tests that were unbiased by intermittent blockages in the venturi sampler (the measurements made from the 19/6 onwards) then the levoglucosan fraction appears to be related to woodheater combustion efficiency with a larger fraction of PM10 comprised of levoglucosan as combustion becomes increasingly oxidative (

Figure 4-13). This trend is opposite to the relationship between PM10-EF and combustion efficiency with the result that levoglucosan EF is relatively insensitive to combustion conditions. The mean levoglucosan EF was 1.25 g (kg fuel burned)⁻¹. A consequence of this is that the airshed-average levoglucosan fraction is probably relatively insensitive to woodheater operation; this could provide a reliable way to quantify biomass combustion emissions in other airsheds where data on heater operation is not available.

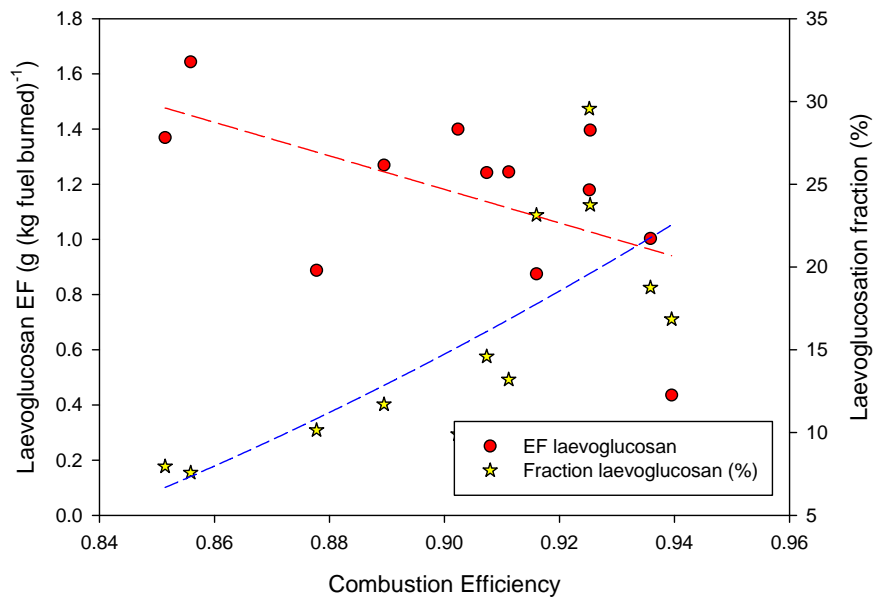

Figure 4-13 The relationship between combustion efficiency and (a) levoglucosan EF (circles) and (b) the fraction (%) of PM10 formed from levoglucosan.

The airshed average levoglucosan fraction can be estimated from an analysis of airshed PM10 mass and levoglucosan fraction. If we assume that high concentrations of PM10 in the Launceston airshed is mostly from biomass combustion (i.e. woodheaters, industrial wood furnaces, such as the plant at Gunns Ltd in Invermay, and open combustion of biomass from forestry and agricultural activities) then at high ambient PM10 concentrations the levoglucosan fraction should approach that of the average woodsmoke source. During the winter of 2002, DEPHA regularly collected 24-h samples of PM10 on glass-fibre filters using Hi-vol samplers at the Ti-tree bend air quality monitoring station. These were analysed at CMAR for gravimetric mass, levoglucosan, organic carbon elemental carbon, total organic matter, and the PM10 mass fractions of levoglucosan and total organic matter (Table 3). The levoglucosan mass fraction of PM10 was plotted against PM10 concentration (Figure 4-14) and fitted with to a rectangular hyperbola to estimate the asymptote, i.e. the average maximum levoglucosan fraction of PM10.

Table 3. Concentrations of PM10 gravimetric mass, levoglucosan, organic carbon (OC), elemental carbon (EC) and total organic matter (TOM) in particulate samples from Launceston, Tasmania. .

Date	PM10 ($\mu\text{g m}^{-3}$)	Levoglucosan ($\mu\text{g m}^{-3}$)	Levoglucosan % of PM ₁₀	OC ($\mu\text{g m}^{-3}$)	EC ($\mu\text{g m}^{-3}$)	TOM ($\mu\text{g m}^{-3}$)	*Woodsmoke PM10 ($\mu\text{g m}^{-3}$)
6-May-02	12.5	1.7	13.7	4.9	0.2	7.1	8.06
8-May-02	59.5	8.9	15.0	23.4	4.3	37.0	42.18
10-May-02	32.4	5.4	16.5	11.8	3.5	20.1	25.59
14-May-02	41.0	6.9	16.9	15.0	3.2	24.2	32.70
17-May-02	18.8	4.7	25.1	8.8	1.4	13.7	22.27
18-May-02	36.3	9.7	26.9	17.4	2.6	27.0	45.97
19-May-02	15.8	2.9	18.3	6.7	0.8	10.2	13.74
22-May-02	36.5	5.5	15.0	11.3	3.5	19.4	26.07
23-May-02	37.8	5.5	14.6	12.2	3.0	20.1	26.07
24-May-02	41.2	7.6	18.5	16.7	3.6	27.0	36.02
25-May-02	32.1	6.1	18.8	14.1	2.1	21.8	28.91
26-May-02	40.1	8.3	20.6	20.2	3.1	31.3	39.34
27-May-02	52.3	10.8	20.7	23.0	4.8	37.0	51.18
29-May-02	54.4	9.4	17.2	26.4	5.4	42.4	44.55
1-Jun-02	51.4	11.2	21.8	25.6	4.3	40.1	53.08
2-Jun-02	34.4	6.7	19.3	17.2	2.7	26.7	31.75
11-Jun-02	2.1	0.1	6.4	1.0	0.2	1.6	0.47
13-Jun-02	24.3	4.1	16.8	9.1	1.9	14.6	19.43
14-Jun-02	62.2	12.9	20.7	27.5	6.4	44.9	61.14
15-Jun-02	46.0	8.9	19.4	21.4	3.7	33.7	42.18
17-Jun-02	17.4	1.6	9.3	4.5	1.5	7.7	7.58
19-Jun-02	41.6	7.3	17.6	18.4	2.5	28.2	34.60
22-Jun-02	3.1	0.2	7.2	1.1	0.1	1.6	0.95
26-Jun-02	12.3	1.5	11.9	3.6	1.0	6.1	7.11
27-Jun-02	16.7	2.5	14.9	4.3	0.5	6.6	11.85

28-Jun-02	26.7	4.4	16.7	10.2	2.1	16.4	20.85
29-Jun-02	66.4	15.0	22.6	32.3	5.1	50.2	71.09
1-Jul-02	18.4	3.1	16.8	7.2	1.8	11.8	14.69
3-Jul-02	8.4	1.1	13.6	1.8	0.4	2.9	5.21
5-Jul-02	23.2	3.5	15.1	7.5	1.3	11.7	16.59
7-Jul-02	14.5	1.4	9.6	3.6	0.4	5.4	6.64
9-Jul-02	5.2	0.5	9.1	1.4	0.3	2.3	2.37
11-Jul-02	42.1	7.8	18.5	16.6	3.4	26.6	36.97
12-Jul-02	36.4	6.3	17.3	11.9	2.7	19.3	29.86
13-Jul-02	35.3	6.4	18.2	13.6	2.7	21.7	30.33
14-Jul-02	23.8	3.6	15.2	9.2	1.4	14.2	17.06
23-Jul-02	33.1	6.2	18.8	13.5	2.7	21.6	29.38
26-Jul-02	19.6	1.8	9.2	3.9	0.6	6.1	8.53
27-Jul-02	39.2	6.1	15.7	13.9	2.6	22.1	28.91
28-Jul-02	16.5	2.5	15.0	6.5	0.5	9.6	11.85
29-Jul-02	53.9	10.1	18.7	22.7	5.3	37.0	47.87
30-Jul-02	28.3	4.5	16.0	11.1	2.5	18.1	21.33
31-Jul-02	28.8	3.9	13.6	9.9	2.4	16.2	18.48
1-Aug-02	5.2	0.6	11.0	0.7	0.4	1.4	2.84
2-Aug-02	41.3	6.8	16.4	15.9	4.1	26.4	32.23
3-Aug-02	35.4	6.5	18.4	15.1	2.6	23.7	30.81
4-Aug-02	48.1	10.1	21.0	22.1	3.5	34.4	47.87
5-Aug-02	22.6	3.2	14.1	9.6	1.5	14.9	15.17
7-Aug-02	5.2	0.5	9.3	1.1	0.1	1.6	2.37
8-Aug-02	45.0	5.4	12.0	14.6	2.9	23.4	25.59
9-Aug-02	16.4	2.1	12.6	5.4	0.9	8.5	9.95

* Estimated from levoglucosan concentration assuming a levoglucosan fraction of 21.1%

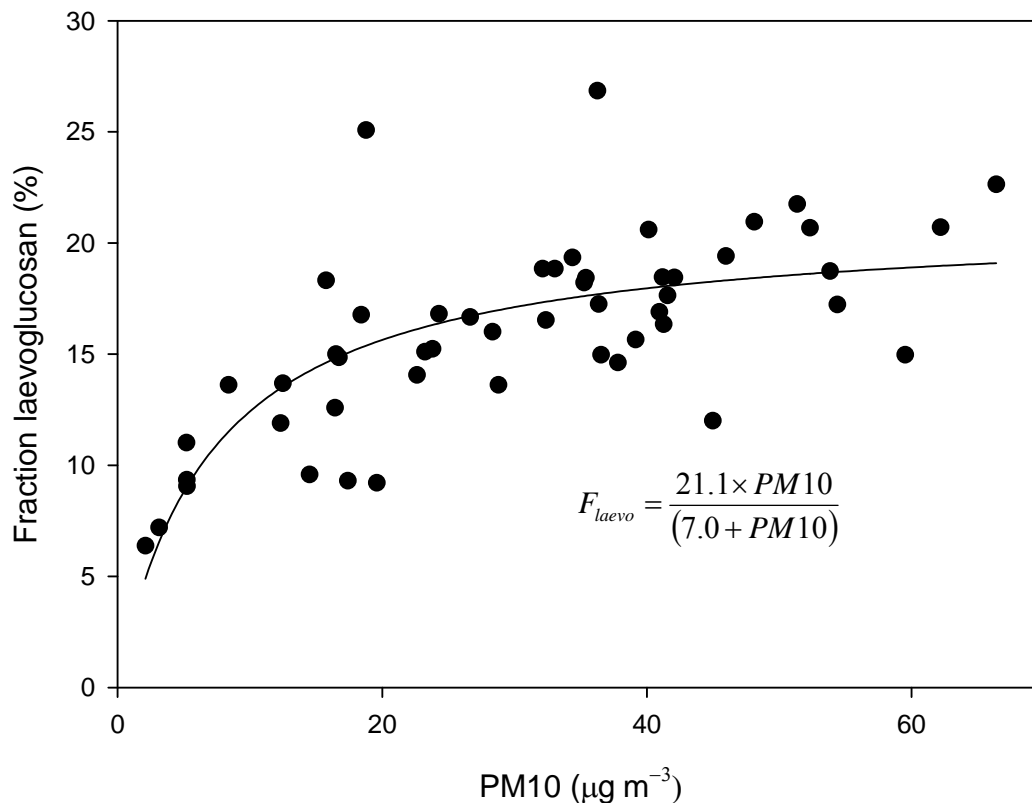

Figure 4-14 Relationship between levoglucosan fraction of PM10 and 14-h mean PM10 mass concentrations measured in Launceston during winter 2002.

The asymptote was $21.1\% \pm 1.3\%$ which is slightly higher than the average value for woodheater PM10 measured in this study, and substantially higher than the 14% reported by Jordan and Seen (2005) from laboratory tests. The woodsmoke PM10 concentration in winter 2002 estimated using this value range from 22% to 126% of the measured 24-h average total PM10 concentrations.

Measurements of elemental carbon and organic carbon were made on the Launceston hi vol filters using a DRI Model 2001A OC/EC carbon analyser by taking a 0.59 cm² area of the filter for analysis. The filter was placed in a quartz boat and analysed using the “cmdImprove” analysis protocol. This produces four organic carbon fractions by increasing temperatures under a helium atmosphere, and three elemental carbon fractions by heating under a mixture of helium and oxygen. The carbon on the filter is converted to carbon dioxide by manganese dioxide and then reduced to methane by a heated nickel catalyst, where it is measured in a flame ionisation detector. An internal standard of methane injected at the end of each analysis was used to quantify the mass of carbon on the filter section.

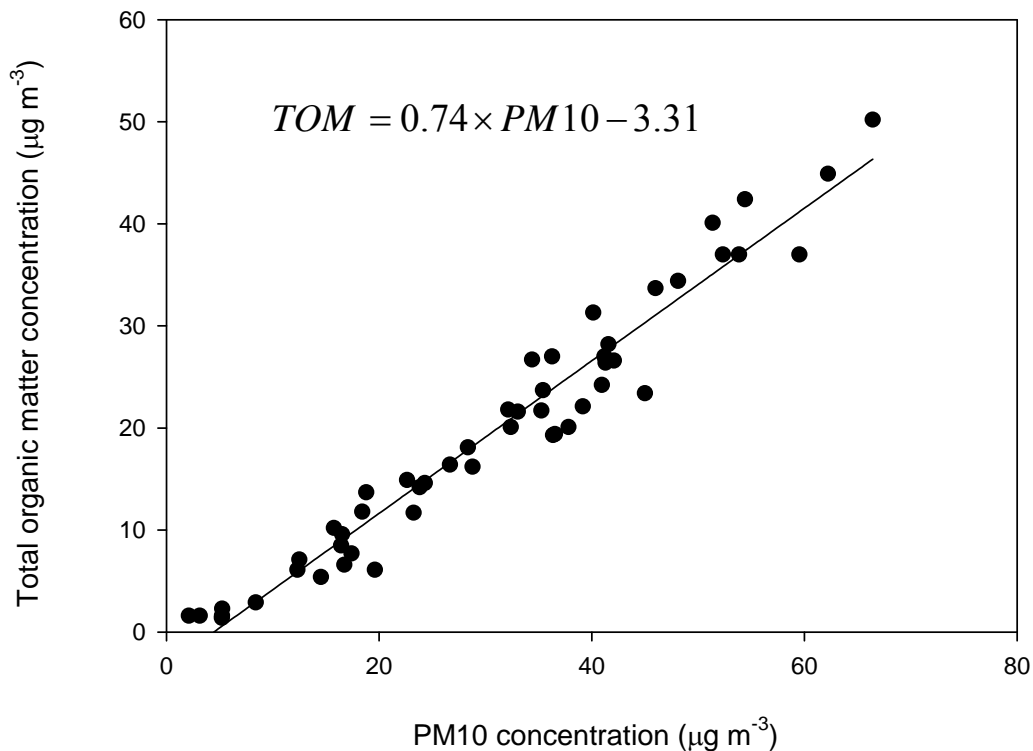

Figure 4-15 The contribution of total organic matter to the PM10 mass concentration contributed by woodsmoke.

Total organic matter (TOM) is the sum of the organic and elemental carbon mass. The sum of the four organic fractions was multiplied by 1.4 to account for other elements, such as hydrogen and oxygen to the elemental carbon mass. Figure 4-15 shows the relationship between TOM measured on the hi-vol samples from Ti Tree bend in Launceston and the calculated PM10 emitted from wood-burning. It indicates that a PM10 concentration of approximately $4 \mu\text{g m}^{-3}$ would be expected without any contribution from biomass burning; above this baseline TOM comprises 74% of total PM10 mass. The relationship has a correlation coefficient of 0.98, which is significant at $p < 0.0001$. The fact that the TOM fraction is consistent over such a wide range of PM10 concentrations is further evidence of a single dominant PM10 emission source in the Launceston airshed.

4.5 *In situ* emission factors

The primary objective of this study was to assess whether the AS/NZ 4013 PM10 emission standard was being met in the real world. Although the AS/NZ 4013 test was not designed to assess heater performance *in situ* but, rather, to provide an objective basis for comparing alternative woodheater designs it is, nevertheless, routinely used for the former. The current Australian methodology for estimating greenhouse gas emissions from domestic woodheaters

(Todd, 2008) for example, draws heavily on AS/NZ 4013 compliance test data and the AS/NZ 4013 toxic emissions study of Gras et al. (2002). Our data confirm that AS/NZ 4013 compliance does not guarantee low PM10 emissions from heater in service. Average daily emissions for the 18 tests range from 2.6 g PM10 (kg fuel burned)⁻¹ to 21.7 g PM10 (kg fuel burned)⁻¹ (Figure 4-16). The average PM10 emission factor was 9.4 g PM10 (kg fuel burned)⁻¹ and the median was 8.6.

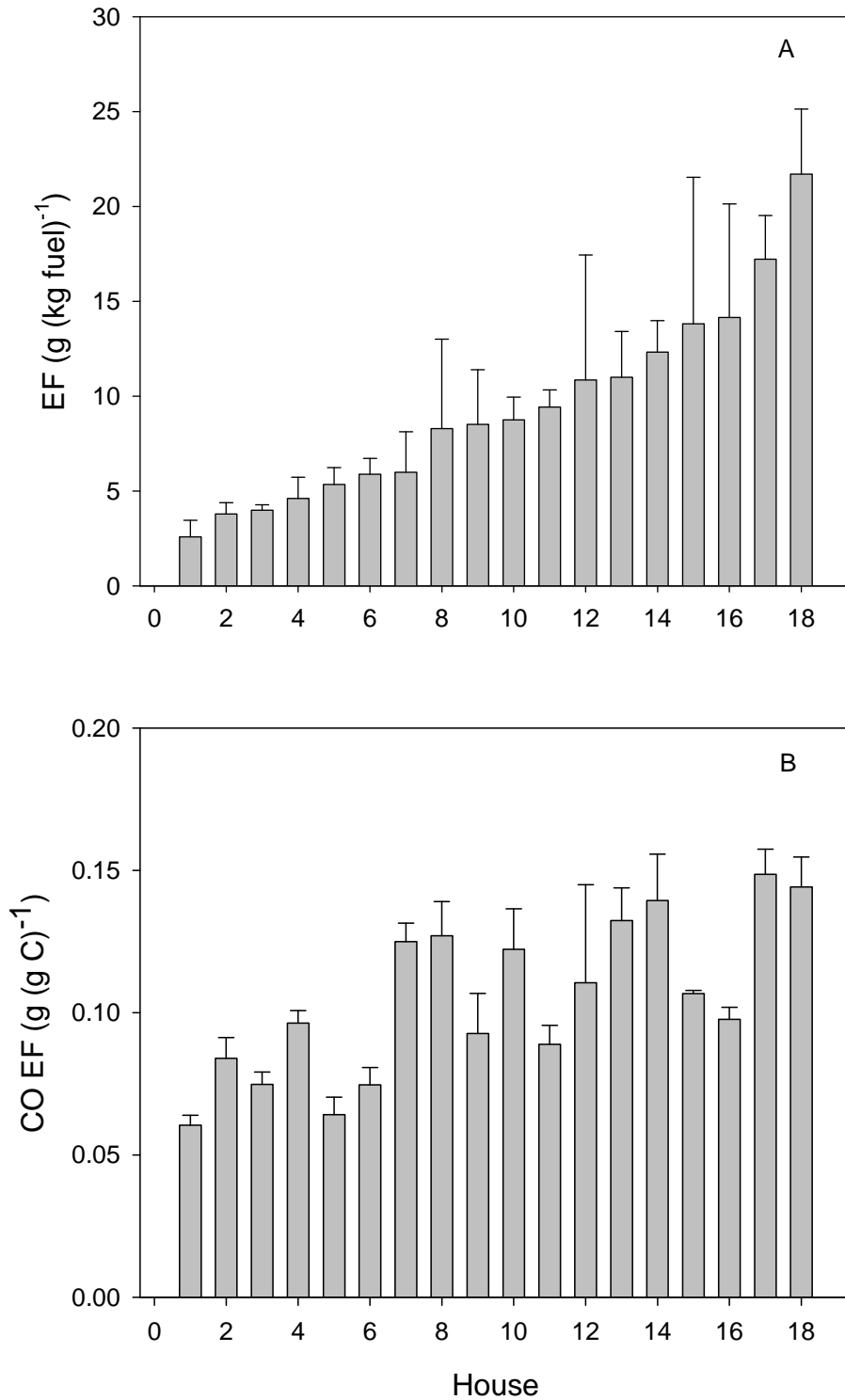

Figure 4-16 A: PM10-EF and B: CO-EF measured in all houses tested in the Launceston air-shed in this study. The PM10-EFs are in rank order. The mean PM10-EF is 9 g PM (kg fuel burned)⁻¹

The major, but not complete, determinant of this range was the rate of air supply; this is indicated by the CO-EF (Figure 4-16), which is an alternative expression of the combustion efficiency (i.e. CO-EF = 1- CEF). The correlation is clearly evident in Figure 4-17. This does not come as a surprise. Gras et al. (2002) came to a similar conclusion. Figure 4-18 presents the emissions data from the 2002 study in relation to CEF. For the hardwood fuels, EF and CEF were described by a single function regardless of whether CEF, i.e. oxygen supply rate, was varied by damper setting, fuel loading, fuel moisture content or heater model. Fuel density appeared to affect PM0-EF differently and the emission factors for pine did not fit the relationship observed for the hardwood fuels. The results from our study, while showing a similar dependency between PM10-EF and CEF to Gras et al.2002, also do not lie on the AS/NZ 4013 hardwood curve.

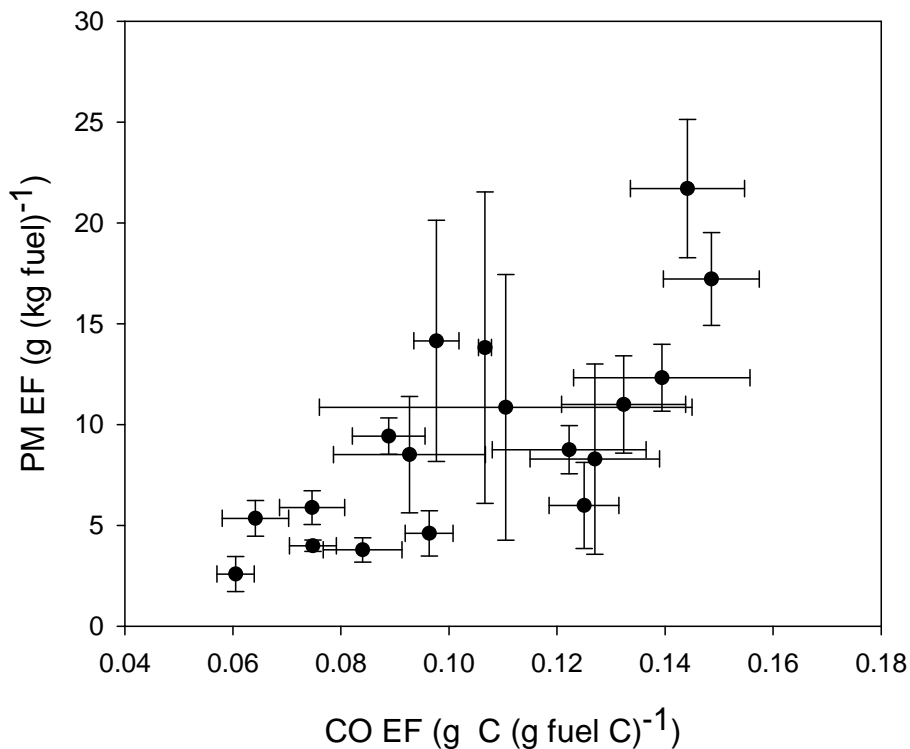

Figure 4-17 Correlation between PM10-EF and CO-EF measured in this study. Each point is the average of all daily PM10-EF factors for each test. The bars are standard errors of the mean.

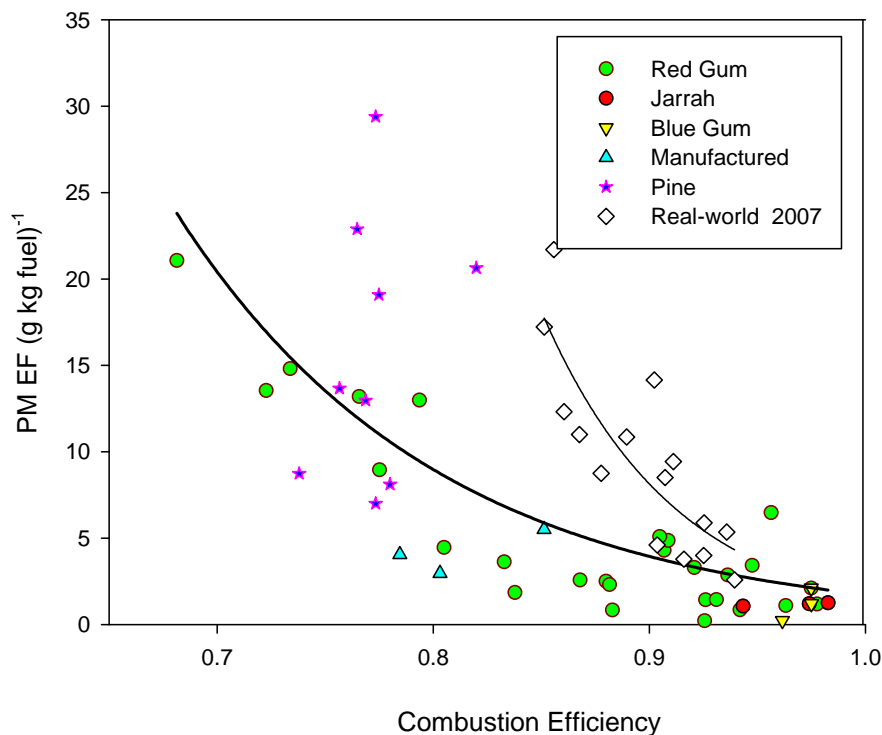

Figure 4-18 Comparison between the effect of combustion efficiency on PM10-EF measured during 4013 tests conducted by Gras et al. (2002) and the real-world PM10 emission factors measured in this study

The daily PM10-EF measured *in situ*, on average, are substantially higher than the AS/NZ 4013 standard of 4 g (kg fuel burned)⁻¹, a finding that is consistent with the conclusions of several other studies. Gras et al. (2000), for example, concluded from a detailed analysis of aerosol distribution in the Launceston airshed that the source emission rates required to explain the atmospheric concentrations of PM10 were a factor of 2-3 higher than their initial estimates which had been based on AS4103 compliance testing. In New Zealand, concern that AS/NZ 4013 might under-estimate PM10 emission from in-service heaters prompted several studies to measure emissions from heaters in private houses (Scott, 2005; Wilton et al., 2006; Kelly et al., 2007) have drawn similar conclusions. Todd (2008) recently reviewed the work and reported that an average PM10-EF from all heaters tested in the 3 NZ studies was 10.9 g (kg fuel burned)⁻¹, which is very similar to this study. Figure 4-19 shows the results of from our study combined with those from the New Zealand measurements and ranked in order of increasing magnitude. Both groups of data have the same range and distribution of PM10-EFs; the mean of the combined data is 10.3 g (kg fuel burned)⁻¹; the median is 8.5 g (kg fuel burned)⁻¹.

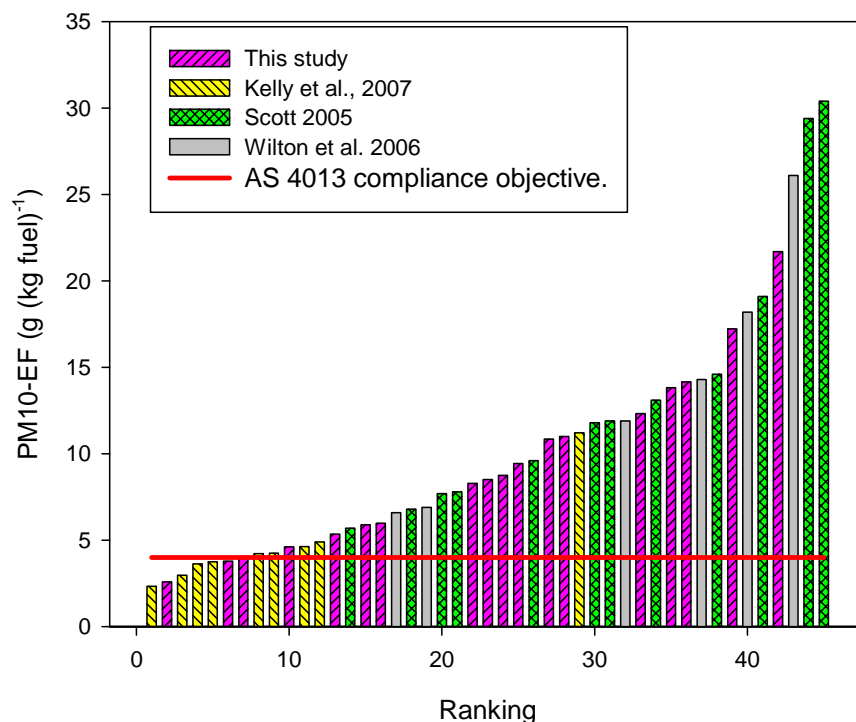

Figure 4-19. Comparison of the results of this study with a summary of three studies of in-service emission factors of Woodheaters in New Zealand (from Todd, 2008). Each test is the average of up to 7 days in-service operation of a single heater. The results are ranked by magnitude.

In summary, this study has produced a number of findings on woodheater operational performance that mostly confirm current expert opinion.

With respect to heater usage pattern it is clear that householders mostly balance fuel consumption with heater efficiency and usually operate the heaters with some degree of air-flow restriction. Heaters are mostly used during the late afternoon and evening. On weekends this extends to the early afternoon and late evening, Daily fuel consumption rates are maximum in the evening hours 18:00 to 20:00, however PM10 emissions occur in two peaks, one late afternoon and early evening, and the second late in the evening when the fire is refuelled. PM10 emission declines rapidly after this second peak and mostly ceases soon after midnight. Where heaters are allowed to burn through the night there is no evidence that they were overloaded and allowed to smoulder; in contrast they appeared to be refuelled periodically throughout the night. The reasons for the nocturnal activities of these householders was not investigated.

Finally there is increasingly strong evidence that the average PM10-EF for in-service domestic woodheaters is approximately 10 g (kg fuel burned)⁻¹, i.e. more than twice the level of the AS/NZ 4013 compliance standard. This draws into question the usefulness of the AS/NZ 4013 standard for estimating the performance of compliant heaters in normal domestic operation.

5 EMISSIONS IN THE LAUNCESTON BASIN

The third objective of this project was to assess how the woodheater emissions affect the concentrations of PM10 in the air-shed. There are two reasons for this; most importantly it is the ambient concentrations of PM10 rather than the concentrations in flue gas that matter for health and environmental amenity, but secondly it is also an independent test of the accuracy and representiveness of the *in situ* survey.

PM10 concentration is monitored continuously by DEPHA at their Air Quality Monitoring Station at Ti Tree Bend, Launceston. Currently the primary instruments are a TEOM (Rupprecht and Patashnick, PA, USA) and an Andersen RAAS Low Volume Air Sampler (LVAS) both fitted with 10 µm size selective inlets. We supplemented this with nitrogen oxide and carbon monoxide analysers (Model 9830T and model 9841T, Ecotech, Knoxfield, Vic). In combination, these tracers provide easily identifiable signatures for biomass combustion and help distinguish woodheaters from other sources of PM10 emissions into the air-shed such as transport, and industrial furnaces.

In the 2007 winter in Launceston daily temperatures ranged from average monthly minima of 1 to 3 °C to maxima of approximately 14 °C (Figure 5-1A). Average daily PM10 varied from 20, 34.4, 30 and 18 µm m⁻³ in May, June, July and August respectively to approximately 14 µm m⁻³ in the other months. There were 7 exceedences of the PM10 NEPM recorded by LVAS; 3 were in June and 2 in July and 2 outside the winter season. There were 4 winter PM10 exceedences recorded using TEOM sampling.

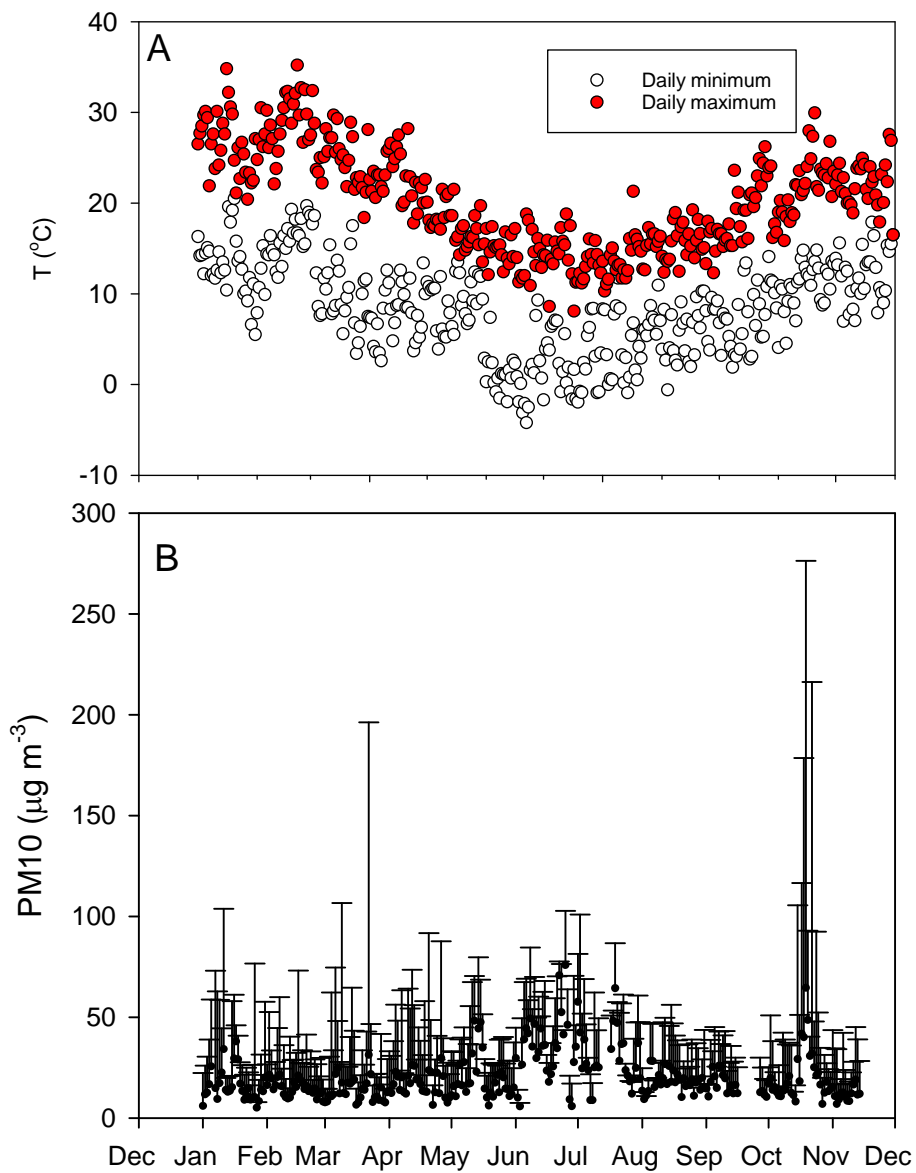

Figure 5-1 Seasonal cycle of A: daily maximums and minimum air temperature, and B: Daily mean and maximum 1-h average PM10 concentration observed at Ti Tree Bend, Launceston during 2007.

What then are the winter emission source signatures? Most of the winter PM will be woodsmoke, which can be estimated from total PM10 using the average laevoglucosan fraction. The mean bivariate plots presented in Figure 5-2 show the relationship between the mean hourly concentration of woodsmoke PM10 and CO (Figure 5-2A) and between CO and NO_x (Figure 5-2B) from mid May until mid September. The woodsmoke PM and CO are strongly correlated with a mean ratio PM/CO-C of 55 mg PM10 (g CO-C)⁻¹ indicating either a single coherent source, or multiple highly correlated sources. Two signatures appear in the NO_x/CO plot. At night from 22:00 to 05:00 the NO_x/CO ratio is 18 mg N (g CO-C)⁻¹ while during the day from 09:00 to 20:00 the NO_x/CO ratio is 52 mg N (g CO-C)⁻¹. Low NO_x/CO is characteristic of biomass combustion where NO_x formation is limited by the nitrogen content of the fuel, typically 0.8% of fuel carbon (Gras et al., 2002). High NO_x/CO is characteristic of stationary and mobile engines where the high combustion temperatures favour oxidation of atmospheric nitrogen. The NO_x/CO signatures are not as coherent as the PM/CO signature, which is normally the case for multiple uncorrelated sources.

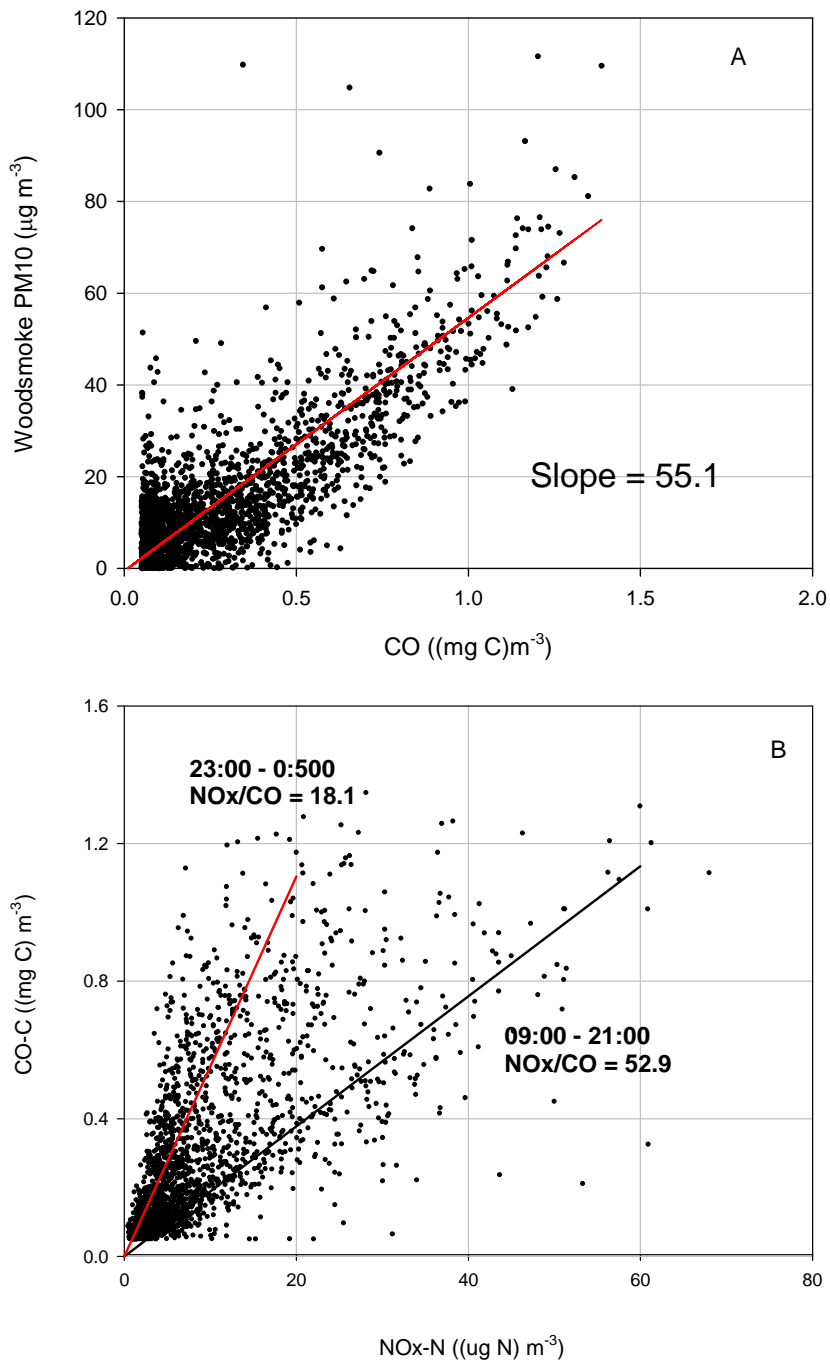

Figure 5-2 Woodsmoke PM10, CO and NO_x at Ti Tree Bend, May to September 2007. A: Correlation between PM10 and CO-C. B: Correlation between CO-C and NO_x-N.

The average diurnal variation in the PM10, CO and NO_x concentrations at Ti Tree bend during winter 2007, is shown in **Error! Reference source not found.A**. PM10 concentration declines during the early morning, but increases in a sharp spike at between 06:00 and 08:00, declines to a daily minimum in mid afternoon then gradually increases during the evening. Carbon monoxide concentration, in contrast, remains high during the early morning with only a minor decline, falls to a minimum in mid afternoon at 2 PM to 3 PM and then steadily increases through the late afternoon and evening to a maximum at midnight. The NO_x concentration

varies in parallel to PM10 until late afternoon when it increases to a maximum at 18:00 then declines slowly until midnight. Qualitatively, this pattern agrees well with our knowledge of some of the sources. The changes in PM10 and CO in the early morning and evening are in accord with the measured patterns of emissions. That is in the early morning, the fires are burning down, PM10 emission ceases however CO emission continues, maybe even increases as the fires continue through the later stages of char combustion. In the evening both CO and PM10 emission rates from woodheaters are large, leading to increasing concentration in the atmosphere. During the day there is a second significant source, probably traffic and industrial emissions characterised by high NO_x/CO in morning and late afternoon peaks.

The diurnal variation in the hourly ratios of PM10 /CO and NO_x/CO presented in **Error! Reference source not found.**B, emphasise the differences between the daytime and the night-time sources. Meteorology is equally important in determining the atmospheric concentrations of pollutants and their diurnal variability; it determines the rate at which the air-shed is ventilated, and, as the mixing height of the boundary changes diurnally, it determines the volume of the air-shed. Both ventilation rate and mixing height are maximum during the day and minimum at dawn. The meteorology of the Launceston air-shed is discussed in detail by Gras et al. (2000).

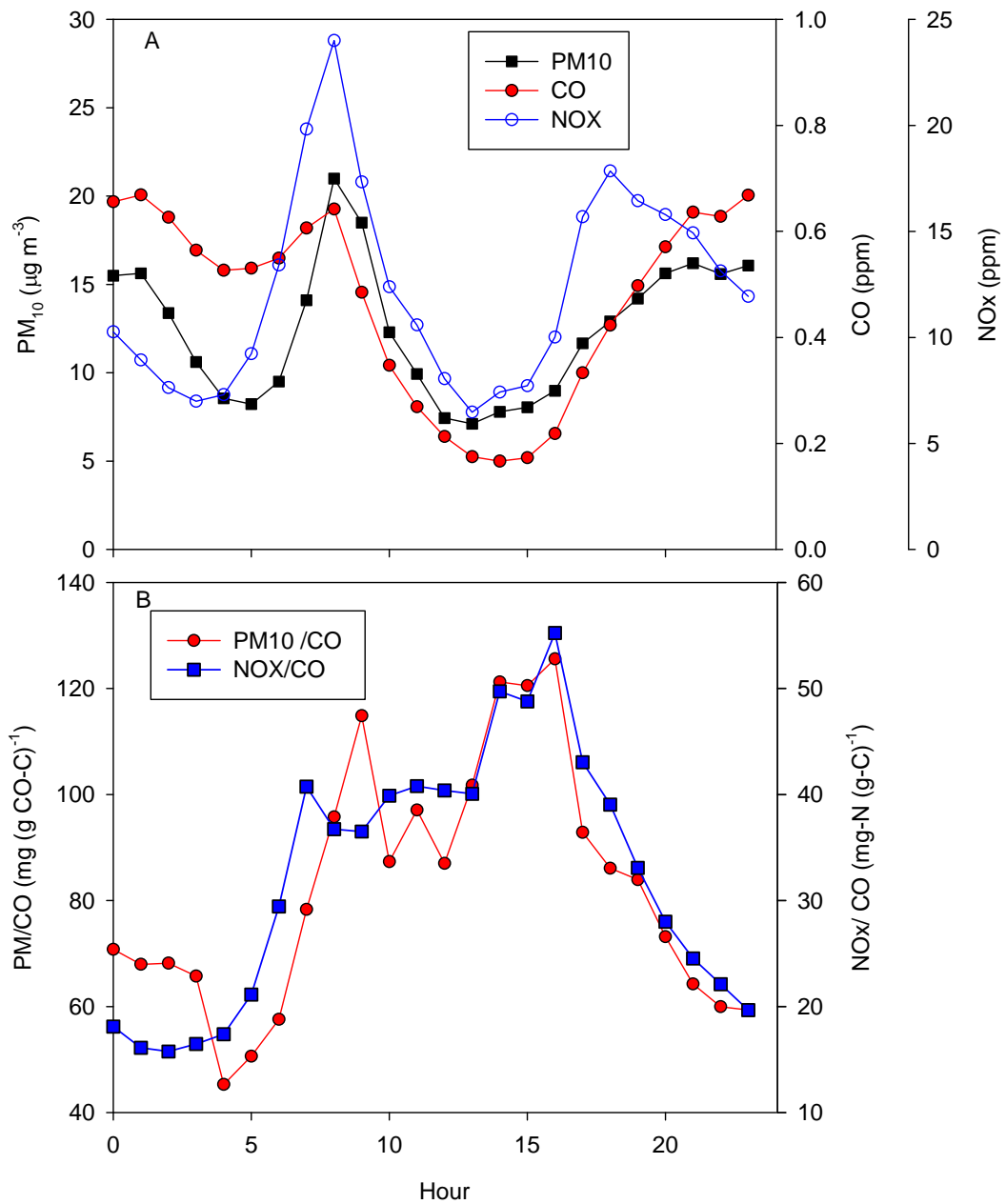

Figure 5-3 Diurnal cycles in pollutants at Ti Tree Bend. Launceston from May to October 2007, A.; PM_{10} , CO and NO_x concentrations. B: Diurnal variation in the PM_{10} -CO and the NO_x -CO emission ratios

When we analyse the signature quantitatively, more complexities emerge. If a source emits two trace pollutants in a constant ratio into an atmospheric system that is near equilibrium then the atmospheric concentration ratio will approach the source emission ratio. In this event, the

atmospheric concentration ratio should equal the average emission ratio from all the components of the spatially distributed source. Fortunately we can make such a comparison because we have a substantial database of emissions information from the AS/NZ 4013 emissions measurements (Gras et al., 2002), and our *in situ* tests which provide information on both the expected source PM10/CO emission ratios and the expected relationship between PM10/CO and PM10-EF (

Figure 5-4).

The results of this comparison are not encouraging. An atmospheric PM10/CO concentration ratio of $55 \text{ mg PM}_{10} (\text{g CO-C})^{-1}$ corresponds to an AS/NZ 4013 PM10-EF or 24h *in situ* PM10-EF of less than $1 \text{ PM}_{10} (\text{g CO-C})^{-1}$; this is far lower than any measured emissions either in AS/NZ 4013 tests or *in situ* measurements and not plausible as an average of all woodheaters operating in the airshed. Additionally, the PM10/CO emission ratios measured both in the AS/NZ 4013 tests (Gras et al., 2002) and the 24h *in situ* measurements average 110 and 170 mg PM10 (g CO-C)⁻¹ respectively; these are 2 to 3 times the atmospheric concentration ratio. Clearly, either the assumptions that the atmosphere behaves as a partially mixed but stable volume or the emission ratios measured in the woodheater tests are in error. The former is, by far, the most probable.

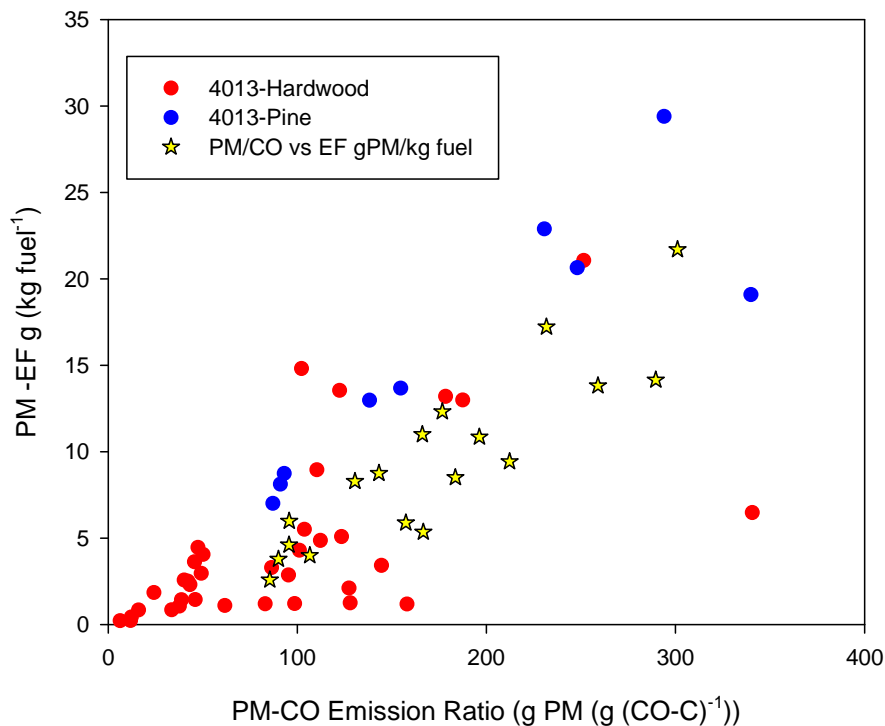

Figure 5-4 Relation between PM10-EF and PM10 to CO emission ratio measured during the AS 43013 tests conducted by Gras et al. (2002) and in this study. A PM-CO emission ratio of 50 corresponds to an PM EF of less than $1 \text{ g PM} (\text{kg fuel})^{-1}$

In reality, the PM10/CO ratio changes throughout the progress of a burn, both in the AS/NZ 4013 tests, which measure the combustion of a single mass of fuel from ignition to ash, and in the *in situ* tests, which monitor the emissions from fires that are regularly refuelled. Also, both the ventilation rate and the air-shed volume change progressively through the day. Therefore the system is never close to equilibrium and, consequently, we need to analyse it hour by hour.

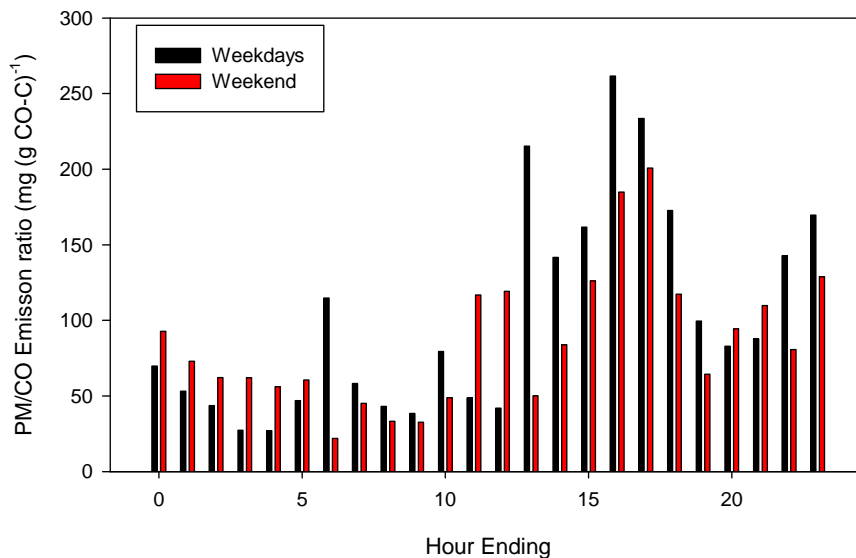

Figure 5-5 Diurnal variation in PM-CO emission ratio for all households tested in this study.

The diurnal pattern of PM10/CO emission ratios from the *in situ* tests (Figure 5-5) shows that PM10/CO ratios close to the mean atmospheric ratio of 55 mg PM10 (g CO-C)⁻¹ occur only in the early morning. This is also the period when both the ventilation rate and the atmospheric mixing height approach their minima, i.e. the stage when the impact of a source on the atmospheric concentration is likely to be greatest. We can compare this hourly variation in source PM10/CO ratio to that in atmospheric concentration ratio (**Error! Reference source not found.**). With the exception of the 09:00 to 12:00 period when emission rates are low, the source PM10/CO ratio and the atmospheric ratio broadly correspond both in phase and in magnitude. The late evening to early morning peak in the source ratio appears lagged by 1-2 hours in the atmospheric concentration ratio, but the magnitude are reasonably similar. However the main emissions peak in the early evening between 6PM – 8PM appears to be strongly attenuated in the atmosphere. At this time of the day both the mixing volume and the ventilation rate typically, are large, and therefore the impact of emissions on atmospheric concentrations is expected to be at a minimum. Overall, the emission characteristics measured at the source appear to be reasonable well represented in the atmospheric concentrations when the diurnal dynamics are taken into account.

Another possibility that could explain the relatively low PM10/CO ratio observed in the atmosphere is the presence of other large biomass combustion sources that are operating at relatively high combustion efficiency in the air-shed. These sources would also have low NO_x/CO signatures, high levoglucosan content but relatively low PM10/CO. There are large

biomass furnaces operating in the industrial zone surrounding Ti Tree bend, however the emissions from these sources would need to be highly correlated with the woodheater emissions, possibly through meteorology to produce the highly coherent signature observed in the atmospheric PM10/CO concentration ratio.

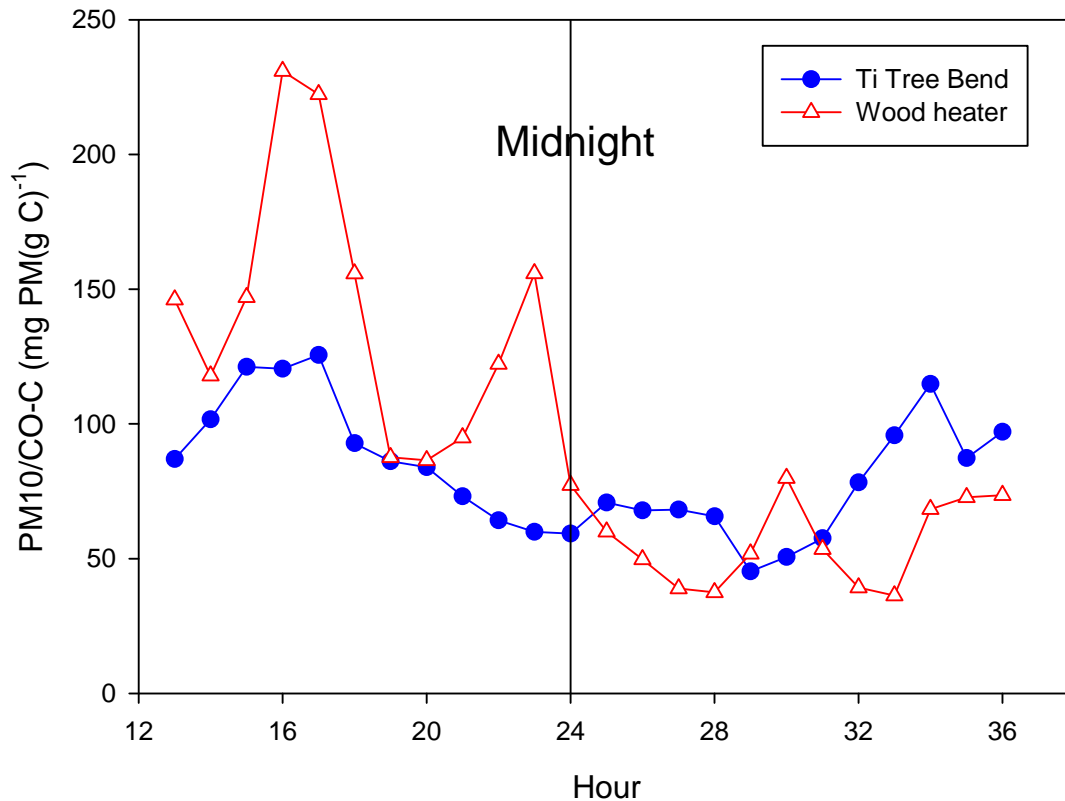

Figure 5-6 PM10/CO woodheater source function and observed concentration ratio at Ti Tree Bend May to September

This analysis leads us to the following conclusions:

- (1) The measured woodheater emissions, qualitatively at least, appear to be consistent with the observed changes in the atmospheric composition at Ti Tree bend.
- (2) The interaction between multiple emission sources means that relation between source emission rates and atmospheric concentrations are inevitably complex. They are unlikely to be resolved other than through the application of atmospheric transport models that describe the diurnal behaviour of the air-shed ventilation rate and mixing volume.
- (3) The timecourse of the emissions is equally important as the average performance characteristic of the heaters for determining impacts of woodheater emissions of the atmosphere. Emission parameters such as AS/NZ 4013 PM10-EF or 24h integrated PM10-EF are, therefore, of limited value for predicting the impact of woodheaters

on the atmospheric PM10 concentrations in an air-shed and, at worst, may be grossly misleading.

In the next section we address the issue of woodheater emissions and atmospheric PM10 concentration through the application of an atmospheric pollution transport model.

5.1 Modelling PM10 exceedences due to woodheater emissions in Launceston

The most recent study reported on modelling PM10 concentrations due to woodheater emissions in Launceston is that by Luhar et al. (2006). They used a comprehensive meteorological and air pollution model called TAPM developed by CSIRO to predict PM10 concentrations for determining the woodheater carrying capacity for Launceston — the number of woodheaters that can operate in the city without exceeding the Air NEPM for PM10. For this purpose, they derived a gridded woodheater PM10 emissions inventory using information on dwelling density, the percentage of dwellings with woodheaters, woodheater emission rates and their diurnal and seasonal variations, and the proportions of various types of woodheaters. Their modelling suggested that the PM10 Air NEPM (allowing up to five exceedences of the Air NEPM limit of $50 \mu\text{g m}^{-3}$ for the daily concentration in a year, of which one to two exceedences are assumed to be in the summertime and not related to woodheaters) would be met in Launceston when the total number of woodheaters decreased to 20% of the total number of dwellings. With the known trends in the regional woodheater profile, this would have occurred in the year 2007.

5.1.1 New emission factors

Luhar et al. (2006) considered three types of woodheaters: compliant (post-1993), non-compliant (pre-1993), and open fireplaces. Their compiled data covering the years 1992–2004 suggested that there was a decreasing trend in the number of dwellings that used woodheaters in Launceston. For the year 2004, 30% of the dwellings were using woodheaters, and an extrapolation of this number to the year 2007 was 20%. They reported data that showed that with time the relative number of compliant woodheaters was increasing, the number of non-compliant woodheaters was decreasing, and the number of open fireplaces was more or less constant, with the respective numbers for the year 2007 being 73%, 20% and 7% of the total woodheaters. It can be assumed that at present virtually all the woodheaters in Launceston are compliant.

Woodheater emission factors are an essential input to deriving emission inventories for use in transports models. Table 4 presents the PM10 emission factors E_f (g per kg of wood burnt) used by Luhar et al. (2006). These emission factors for the compliant woodheaters are substantially lower than those estimated by the present study (see. Table 4). At present, virtually all woodheaters in Launceston are compliant and there is not a large distinction in emissions between compliant and non-compliant woodheaters. We assume that the new emission factors apply to all woodheaters, except open fireplaces, for which, in the absence of new data, we use the same emission factor as before. The diurnal cycle of heater usage (the hourly variation of air flow settings) assumed in the model is combined with the revised emission factors to produce a

weighted 24hour average emission factor of $10.6 \text{ g (kg fuel burned)}^{-1}$. This value is very close to the mean EF of all tests both in this study and the NZ studies discussed earlier.

Table 4 PM10 emission factors for woodheaters.

Flow conditions	Compliant woodheater			Non-compliant woodheater			Open fireplace
	High	Low	Overload	High	Low	Overload	All
E_f (g kg ⁻¹) – Luhar et al., 2006	1.3	5.2	10.4	2.6	12.2	17.5	17.5
E_f (g kg ⁻¹) – New	5.0	10.0	15.0	5.0	10.0	15.0	17.5

The new emission factors given in Table 4 were used in TAPM, and concentrations of PM10 at Ti Tree Bend were recalculated.

We briefly describe TAPM and the model settings before presenting the model results.

5.1.2 TAPM

TAPM is a three-dimensional, prognostic meteorological and air pollution model (see Hurley et al., 2005; Hurley, 2006; <http://www.cmar.csiro.au/research/tapm> for model details). Given the large-scale synoptic analyses as input boundary conditions for the horizontal wind components, temperature and moisture, TAPM simulates local scales at a finer resolution using a one-way multiple nesting approach, predicting local-scale meteorology, typically down to a resolution of 1 km, such as sea breezes and terrain induced flows. The synoptic input is supplied from the Australian Bureau of Meteorology's GASP modelling system (given at 6-hourly intervals at approximately 100-km spaced grid points across Australia). Other inputs to the model include global databases of terrain height (given at a horizontal resolution of about 250 m for Australia), land use, and monthly sea-surface temperature. The air pollution transport component of TAPM consists of an Eulerian grid-based set of conservation equations for species for determining a spatially explicit distribution of time varying ground-level pollutant concentrations, either using the default Eulerian grid-based approach (used in our calculations) or a Lagrangian particle approach targeted at important point sources. The air pollution component is normally run coupled with the meteorological component.

The performance of TAPM has been verified in a number of previous meteorological and dispersion studies, e.g. Luhar and Hurley (2003), Hurley (2006).

The gridded PM10 emission calculation methodology was the same as that described by Luhar et al. (2006), except that the new emission factors given in Table 4 were used. In TAPM, we considered four nested grid domains at 30, 10, 3, 1 km resolution for meteorology (21 × 21 grid points) and four nested grid domains at 15, 5, 1.5 and 0.5 km for pollution (41 × 41 grid points), all centred at the location (147°7.5' E, 41°26.5' S), which is equivalent to 510.442 km east and 5412.189 km north in the AMG84 (Australian Map Grid) coordinate system. The outermost meteorological domain covered Tasmania entirely while the innermost domain covered an area of 20 km × 20 km centred on Launceston. The innermost domain includes nearly all of the woodheater emissions in Launceston. The default values of the monthly sea-surface temperature

and the volumetric deep soil moisture content were used. The concentration simulations were done for the year 1998 and the results were scaled to other years based on trends in woodheater numbers (see Luhar et al., 2006). A background concentration of $12 \mu\text{g m}^{-3}$ was added to the modelled concentrations.

5.1.3 Model results

Figure 5-7 compares the number of the PM10 exceedences determined from the model concentrations with the observed exceedences at Ti Tree Bend as a function of year. The data were taken from Luhar et al., and some of the recent values were obtained from the Environment Division of DEPHA (see http://www.environment.tas.gov.au/anw_aq_map_pollution_data_launceston.html). Typically, there are one or two PM10 exceedences during summer (October–April) in a given year (e.g. due to bushfires), which the model does not account for. Such exceedences were removed from the data for the year 2002 onwards. Figure 5-7 shows that there has been a general decrease in the number of exceedences over the years, as a result of associated with a decline in the woodheater usage. For the last two years, the number of wintertime exceedences is below the NEPM limit of five.

In Figure 5-7 there is a good agreement between the data and the model curve of Luhar et al. (2006). However, the number of exceedences determined from the model using the new emission factors is generally higher than the observations, and always higher than the Luhar et al. curve.

Luhar et al. (2006) found it necessary to multiply an empirical correction factor of 1.2 to the modelled concentrations to match the observations. This was a somewhat arbitrary factor that was justified through a mass balance argument that the total emission of PM10 due to woodheaters in Launceston determined using the emission methodology amounted to 506 tonnes for the year 2000, which was lower than 609 tonnes reported in EA (2001); the latter is a factor of 1.2 higher. It is clear that overall the newly derived real-world emission factors are higher than those used by Luhar et al., and that probably explains why the factor of 1.2 was necessary. We omitted this factor in our calculations, and the results are plotted in Figure 5-7 (labelled ‘No correction’). The new curve closely follows the Luhar et al. curve. Thus it is apparent that the newly derived emission factors have reduced the systematic error in the emission calculations.

The main uncertainty in the modelling is the woodheater numbers and their spatial distribution in Launceston. The satisfactory results obtained in the present study imply that the use of dwelling density distribution as a proxy of woodheater density distribution is not an unrealistic assumption. However, it needs to be verified through field data.

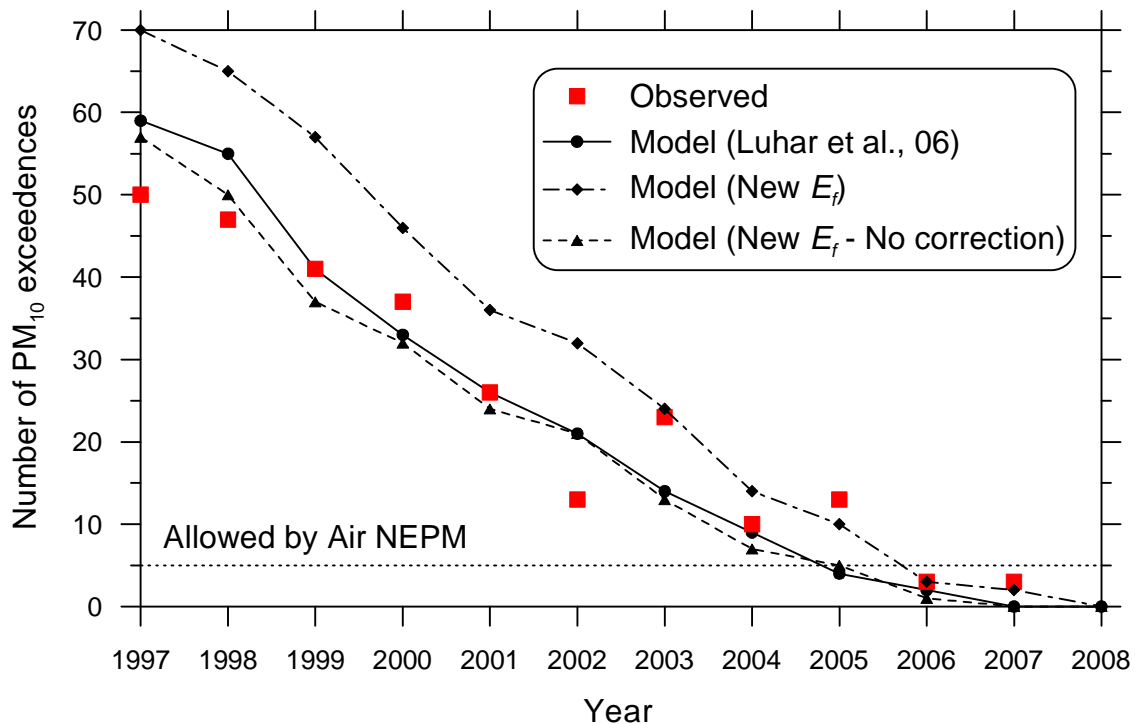

Figure 5-7 Comparison of the number of exceedences of the PM10 Air NEPM determined from the modelled concentrations (with various emission options) with the observed number at the Ti Tree Bend

6 GENERAL DISCUSSION AND CONCLUSIONS

People are generally exposed to PM10 and associated toxic compounds produced by woodheaters in the ambient atmosphere and, therefore, the key issues for policy development for air quality and environmental health is the contribution that woodheaters have on ambient concentrations of particulate and gaseous pollutants. The path from woodheater design to ambient pollution concentration involves at least three steps: verifying the heaters design characteristic, quantifying the source emission properties of the heaters in service, and quantifying the contribution of these source emissions to the ambient pollution concentrations. The first step is addressed by the AS4103 standard. The objective of this study was the second and third steps.

This study suggests that the PM10-EF determined by the AS/NZ 4013 compliance test does not give a good indication of the performance of domestic woodheaters that are installed in houses and operated normally and probably underestimates it by at least a factor of 2. The issue here is not so much that the AS/NZ 4013 test gives the wrong results; its purpose is to compare heater designs by an objective and reproducible protocol, but that the PM10-EF derived from the test is not an accurate indicator of *in situ* performance of the heaters. Unfortunately, in the absence of alternatives, the compliance test data is used in precisely that way.

There are two problems with the test method as a predictor of emissions for in-service heaters. The first is that the test does not replicate the way heaters are mostly used in practice; that is

ignited cold, allowed to burn vigorously and then refuelled periodically, usually with relatively small masses of fuel. The AS/NZ 4013 protocol allows a large charge of fuel to burn to completion in a single batch in contrast to domestic operation, which tends toward continuous feed. The former progresses through pyrolysis to char combustion; the latter maintains some intermediate and with it a more extended and continuous emission of PM10. The second problem is that it is extremely difficult to convert the PM10-EF derived from a batch burn in to an instantaneous emission rate. The combined result is that AS/NZ 4013 is of limited value for guiding policy to reduce the impact of woodheater pollution.

This study has made some progress towards resolving the problem. Firstly it is clear that dispersion models are an essential step in translating source emission rates to atmospheric concentrations. These models require the timecourse of emission rates, which in turn requires a measure of both concentration ratios and a measure of either fuel consumption rate or air flow rate. This study has demonstrated at least one way of achieving this. However for full confidence in the results a few steps remain.

First, there are technical issues in the sampler design that need to be resolved and improved. The most important of these is to refine the primary diluter design to minimise or remove the risk of blockages. The second issue is that despite attention to minimise PM10 losses in sampling, inevitably the sampling efficiency will be less than 100% and therefore the sampler will almost certainly underestimate actual PM10 emissions. It is essential therefore to quantify these losses through calibration. Probably the only practical way to achieve this is in an AS/NZ 4013 dilution tunnel; this would have the additional benefit of providing a direct calibration of the field sampling system against the AS/NZ 4013 standard.

The addition of a 1.2 m extension to the household flue is also likely to affect the emission results. The increase in flue length will enhance the stack effect and hence increase the air flow rates at all damper positions. However, this will be offset to some degree by the restriction to flow caused by the 100 mm orifice plate. Although we expect these effects to be minor, their magnitude should be quantified in future studies.

Field sampling campaigns are inevitably limited to relatively small population sizes due to their complexity and cost. Surrogate measures of *in situ* heater use or performance could be investigated. Flue temperature, for example in this study proved to be a good indicator of the timecourse of heater use, including information on air flow control. However to improve heater performance in the long term requires emissions to be characterised by combustion parameters that can be easily measured and controlled. Without this, continued heater design is likely to be haphazard and expensive.

Ambient monitoring of criteria pollutants for regulatory reporting provides an essential database for assessing policy impacts, however monitoring additional tracers dramatically improves the value of the resource. With reliable time-series of multiple chemical species it becomes possible to assess the impacts of an interaction of complex combinations of emission sources and to direct policy initiatives accurately and effectively. Even though the probability of these tracers exceeding NEPM concentrations is minimal, they add substantial value to primary species, and in time, are likely to become an essential input for air quality models used for regulation and advice. Instruments suitable for accurately monitoring ambient levels of trace species such as CO and NO_x are now readily available.

The fact that the AS/NZ 4013 protocol underestimates *in situ* emissions highlights the potential for improvement more than the inadequacy of the standard. The implementation of policy initiatives to reduce emissions through education campaigns, policing and the woodheater buy-back scheme is correlated with the ambient record of air quality which shows that annual PM10 exceedences have declined from 50 to less than 5 within a decade. An improvement in operator use is apparent in the reduction in observed emission rates; Gras et al. (2000) concluded that emission rates of PM10 in Launceston were 12 to 28 g PM10 h⁻¹. By 2007, the average maximum emission rates were 8 g h⁻¹, with clear evidence that heaters were no longer operated for long periods their heaters with minimum airflow. These changes have been achieved despite the emission standard being exceeded by a factor of 2.

This study has provided important information on the diurnal cycle of woodheater usage and associated emission parameters that will be very useful in refining emission inventories for transport modelling. The new PM10 emission factor derived here has a daily mean value of 10.6 g (kg fuel burned)⁻¹, which is substantially higher than that derived and used in a number of previous studies (e.g. Gras et al., 2002; Luhar et al., 2006). This higher value also explains why the previous modelling study by Luhar et al. underpredicted the PM10 concentrations, necessitating somewhat arbitrary correction factors.

Several areas of uncertainty remain in the modelling study. Three are potentially significant:

1. The number of heaters measured was small fraction of the total heater population. Households were selected from a volunteers, rather than randomly selected from the heater population. Although heater performance was consistent with the behaviour of PM10, CO and NO_x concentrations in the airshed, the possibility remains that the cohort is biased to some degree. Additional testing of randomly selected heaters would improve the issue.
2. The study assumed that the spatial distribution of woodheater numbers and useage in the airshed was the same as the spatial distribution of the dwellings. This should be confirmed by a survey.
3. There is very limited data available on emissions from open fireplaces. The AS/NZ 4013 tests of fireplace inserts (Gras et al., 2002) low emission factors, however other studies found them to be large (US EPA,1996; Todd, 2008). Direct measurement of fireplace emissions and emission factors is usually difficult, however the sampling system developed for this study could easily be adapted for *in situ* fireplace testing.

Finally, there seems to be a strong case for developing a new test cycle that reflects the way in which heaters are actually used, and measures parameters that can reliably define the source fields for atmospheric dispersion models for planning, policy development and verification.

REFERENCES

- Andreae, M.O. and Merlet, P. (2001), Emission of trace gases and aerosols from biomass burning, *Global Biogeochemical Cycles*, 15, 955.
- Bin Abas, R.M., Oros, D.R. and Simoneit, B.R.T. (2004), Biomass burning as the main source of organic aerosol particulate matter in Malaysia during haze episodes, *Chemosphere*, 55, 1089.
- Dixon, R.W. and Baltzell, G. (2006), Determination of levoglucosan in atmospheric aerosol using high performance liquid chromatography with aerosol charge detection, *Journal of Chromatography A*, 1109, 214.
- Dye, C. and Yttri, K.E. (2005), Determination of monosaccharide anhydrides in atmospheric aerosols by use of high-performance liquid chromatography combined with high resolution mass spectrometry, *Analytical Chemistry*, 77, 1853.
- EA (Environment Australia) (2001), Wood-heater Woodheater Emissions Management: Program for the Tamar Valley – Scoping Study. Submitted to Environment Australia by Atech Group, May 2001, p. 94. Available at <http://www.deh.gov.au/atmosphere/airquality/publications/tamar/>.
- Elias, V.O., Simoneit, B.R.T., Cordeiro, R.C. and Turcq, B. (2001), Evaluating levoglucosan as an indicator of biomass burning in Carajas, Amazonia: A comparison to the charcoal record, *Geochimica et Cosmochimica Acta*, 65, 267.
- Engling G., Carrico, C.M., Kreidenweis, S.M., Collett, J.L. Jr, Day, D.E., Malm, W.C., Lincoln, E., Hao, Wei Min W-M, Iinuma, Y. and Herrmann, H. (2006), Determination of levoglucosan in biomass combustion aerosol by high performance anion-exchange chromatography with pulsed amperometric detection, *Atmospheric Environment*, 40, 299.
- Fraser, M.P. and Lakshmanan, K. (2000), Using Levoglucosan as a Molecular Marker for the Long-Range Transport of Biomass Combustion Aerosols, *Environ. Sci. Technol.*, 34, 4560.
- Galbally, I.E. (2004), personal monitoring of selected VOCs: the contribution of woodsmoke to exposure. Technical report #8, Commonwealth department of Environment and Heritage. 75p. <http://www.deh.gov.au/atmosphere>.
- Gras J.L., M.D. Keywood, M.D. and G.P Ayers, G.P. (2000), Factors controlling winter-time light-scattering in Launceston. *Atmospheric Environment*, 35, 1881.
- Gras, J. L., and Meyer, C. P. (2003), The duration of smokiness after fuelling, in the Environment Australia-CSIRO woodsmoke emissions study. Aspendale, Vic., CSIRO Atmospheric Research. 15 p.
- Gras, J. L., Meyer, C. P., Weeks, I. A., Gillett, R. W., Galbally, I. E., Todd, J., Carnovale, F., Joynt, R. C., Hinwood, A., Berko, H., and Brown, S. (2002), Emissions from domestic solid

fuel burning appliances [wood-heaterwoodheaters, open fireplaces]. Canberra: Environment Australia. (Technical report; no. 5). ix, 95 p.

Wei Min Hao W-M.,oa, Ward, D. E., Olbu, G. and , Baker, S. P. (1996), Emissions of CO₂, CO and hydrocarbons from fires in diverse African savanna ecosystems, *Journal of Geophysical Research*, 101, 23577.

Hsu Ching-Lin, Chen Chin-YuangC-Y., Lee Chung-TeC-T, and Ding Wang-HseinW-S., (2007), Derivatisation procedures and determination of levoglucosan and related monosaccharide anhydrides in atmospheric aerosols by gas chromatography-mass spectrometry, *Talanta*, 72, 199.

Hurley, P. J., (2006), An evaluation and inter-comparison of AUSPLUME, AERMOD and TAPM for seven field datasets of point source dispersion. *Clean Air and Environmental Quality (Aust.)* 40, 45.

Hurley, P. J., Physick, W. L., Luhar, A. K. (2005), TAPM: a practical approach to prognostic meteorological and air pollution modelling. *Environmental Modelling and Software* 20, 737.

Hurst D. F., Griffith D. W.T., Carras J. N., Williams D. J., and Fraser P. J. (1994), Measurement of trace gases emitted by Australian savanna fires during the 1990 dry season, *Journal of Atmospheric Chemistry*, 18, 33.

Jordan, T.B. and Seen, A.J. (2005), Effect of aAirflow setting on the organic composition of woodheaterwoodheater emissions, *Environmental Science and Technology*, 39, 3601.

Jordan, T.B, Seen, A.J., Jacobsen, G.E. and Gras, J.L. (2006a), Radiocarbon determination of woodsmoke contribution to air particulate matter in Launceston, Tasmania, *Atmospheric Environment*, 40, 2575.

Jordan, T.B., Seen, A.J. and Jacobsen, G.E. (2006b), Levoglucosan as an atmospheric tracer for woodsmoke, *Atmospheric Environment* 40, 5316.

Kelly, C., Mues, S. and Webley, W. (2007), Real-Life Emissions Testing of Wood Burners in Tokoroa, Warm Homes Technical Report, Ministry for the Environment, Wellington NZ.

Luhar, A. K., and Hurley, P. J. (2003), Evaluation of TAPM, a prognostic meteorological and air pollution model, using urban and rural point-source data. *Atmospheric Environment*, 37, 2795.

Luhar, A. K., Galbally, I. E. and, Keywood, M.D. (2006), Modelling PM10 concentrations and carrying capacity associated with wood-heaterwoodheater emissions in Launceston, Tasmania. *Atmospheric Environment*, 40, 5543.

Pashynska, V., Vermeylen, R., Vas, G., Maenhaut, W. and Claeys, M. (2002), Development of a gas chromatographic/ion trap mass spectrometric method for the determination of levoglucosan and saccharidic saccharide compounds in atmospheric aerosols (application to urban aerosols), *Journal of Mass Spectrometry*, 37, 1249.

Pictet, A. and Sarasin, J. (1918), Sur la distillation de la cellulose et de l' amidon sous pression reduite, Helvetica Chimica Acta, 1, 87. R. Alger, National Bureau of Standards Special Publication, 1972, 171.

Richards, G.N., Shafizadeh, F. and Stevenson, T.T. (1983), Influence of sodium chloride on volatile products formed by pyrolysis of cellulose: identification of hydroxybenzenes and 1-hydroxy-2-propanone as major products, Carbohydrate Research, 117, 322.

Saarikoski, S., Sillanpaa, M., Sofiev, M., Timonen, H., K. Saarnio, T.einila K., Karppinen, A., Kukkonen, J. and Hillamo, R. (2007), Chemical composition of aerosols during a major biomass burning episode over northern Europe in Spring 2006: Experimental and modelling assessments, Atmospheric Environment, 41, 3577.

Schkolnik G., Falkovich, A.H., Rudich, Y., Meinhart, W. and Artaxo, P. (2005), New analytical method for the determination of levoglucosan, polyhydroxy compounds and 2-methylerythritol and its application to smoke and rainwater samples, Environmental Science and Technology, 39, 744.

Scott, A.J. (2005), Real-life emissions from residential wood burning appliances in New Zealand; Ministry for the Environment, Wellington, NZ.

Shafizadeh, F. (1984), The chemistry of pyrolysis and combustion, In: Rowell R. (Ed.) Chemistry of solid wood, Advanced Chemistry Series 207, American Chemical Society, Washington (D,C.), p489.

Simoneit, B.R.T., Schauer, J.J., Nolte, C.G., Oros, D.R., Elias, V.O., Fraser, M.P., Rogge, W.F., and Cass, G.R. (1999), Levoglucosan, a tracer for cellulose in biomass burning and atmospheric particles, Atmospheric Environment, 33, 173.

Simpson, C.D., Dills, R.L., Katz, B.S. and D.A. Kalman, D.A. (2004), Determination of levoglucosan in fine particulate matter, Journal of the Air and Waste Management Association, 54, 689.

Todd, J.J. (2008), Estimating greenhouse gas emissions from residential firewood use in Australia 1989/90 to 2003/4. Report prepared for the Australian Department of Climate Change by Eco-Energy Options Pty Ltd, March 2008, 85p.

US EPA (1996) AP-42 Compilation of Air Pollutant Emission Factors Vol 1 Stationary Point and Area Sources, United States Environmental Protection Agency, available at www.epa.gov/ttn/chief/index.html.

Wilton, E., Smith, J., Dey, K. and Webley, W. (2006), Real life testing of wood burner emissions, Clean Air and Environmental Quality 60, 43.

Yttri, K.E., Dye, C., Slørdal, L.H., Braathen, O-A., Hornig, J.F., Soderburg, R.H., Barefoot, A.C. III and Galasyn, J.F. (1985), In: Cooke M. and Dennis A.J. (Eds.) Polynuclear Aromatic Hydrocarbons: Mechanisms, Methods and Metabolism. Battelle Press. Columbus, 1985, p561.

APPENDIX A

Field installation check list

CARP Real World PM10 Emissions

Location

Date	
Location	Lat
Name	Long
Heater model	
Box volume	
Flue height	Diameter

UNIT ID

Unit	
Dustrak	

FLUE

	Start	End
Flue extension	Cleaned: Y / N	Clear: Y / N
Orifice plate ports	Cleaned: Y / N	Clear: Y / N
Primary diluter inlet	Cleaned: Y / N	Clear: Y / N
Pressure lines	Cleaned: Y / N	Clear: Y / N
Water trap	Cleaned: Y / N	Clear: Y / N

SCRUBBERS

Glass Wool		
Teflon Gas Filter		
Charcoal		
Purafil		
Carbosorb		

DustTrak

Clean impactor		
Set zero		
Flow check (1.7V)		
Check Dustrak time		
Range (100mg/m3)		
Battery		
Time const		
Log interval		
Memory remaining (>50%)		
Log		

FILTERS

	Label	On (time, date)	Off (time,date)	
TSP1				
TSP2				
TSP3				

FLOWS

ID	Goal	Start		End	
		Flow	Status	Flow	Status
Primary diluter	4.5-5 lpm				
Sample (particles)	1.5-2.5 lpm				
Sample (gas)	0.5 – 1 lpm				
Gas Sensor Flow	1-1.5 lpm				
TSP1	~0.5				
TSP2	~0.5				
TSP3	~0.5				
Dustrak	1.7 lpm				
Particle vent	>0				

CONNECTIONS

Primary diln air		Pressure lines	
Gas Sample		Thermocouples	
Particle sample		DustTrak power	
Water trap		DustTrak signal	
Gas diln T		DustTrak serial	
Gas supply to sensor		Modem	
TSP1			
TSP2		Charger Power	
TSP3		Battery Power	
DustTrack			
Vent			

LOGGER

Date ok		Reset from:		To:	
Time ok		Reset from:		To:	
Flows		Sensor	Reading	OK	
Primary dil		CO ₂ -P			
Secondary dil		CO ₂ -P (noflow)			
Gas sample		Flue Temp1			
Gas Diln Air		Flue Temp2			
TSP1					
TSP2		Condensor set			
TSP3		Condensor read			
		Flue Pressure			
		CO ₂ -sensor			
		CO-sensor			

Operation

Control	Status
Secondary diluter valves	

APPENDIX B.

Real-world Woodheater PM10 Emissions Project, 2006/2007

Operations Diary

Date:

Location

Household		
Address		
Phone	Daytime:	Evening:
Location	Lat:	Long:

Heater Details

Manufacturer:		
Model:		
Age:	(years)	
Compliant	<i>Yes</i>	<i>No</i>
Emissions rating	(g/kg fuel burned)	
Flue type	<i>Free standing</i>	<i>In-chimney</i>

Fuel Details

Fuel	<i>hardwood</i>	<i>softwood</i>	<i>manufactured</i>	<i>other</i>
	<i>seasoned</i>	<i>green</i>		

Age	(years)
Years since last cleaned	(years)

Kindling Starters	<i>twigs</i>	<i>pine</i>	<i>split logs</i>	<i>other</i>
	<i>paper</i>	<i>firelighters</i>	<i>other</i>	

Day 1. Date:

Time	Operation	Fire/ fuel state				Comments
	<i>Ignition/ stoking/ reloading</i>	<i>Weight of fuel added (kg)</i>	<i>Fuel surface (Wet/Dry)</i>	<i>Loading (light/ full/ packed)</i>	<i>Damper setting (full/part- open/shut)</i>	

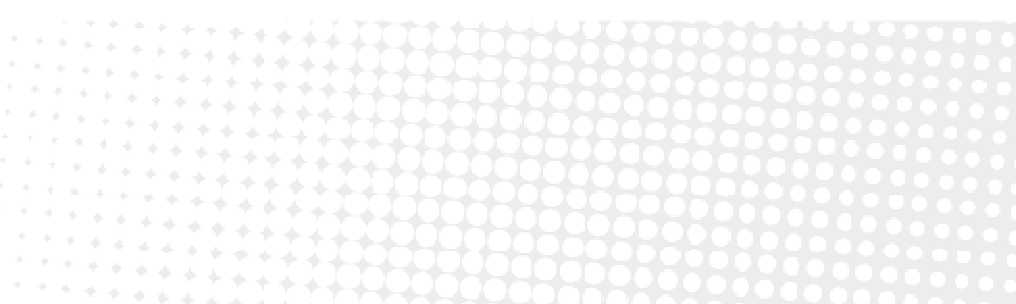

Contact Us

Phone: 1 300 363 400

+61 3 9545 2176

Email: enquiries@csiro.au

Web: www.csiro.au

Your CSIRO

Australia is funding its future on science and innovation. Its national science agency, CSIRO, is a powerhouse of ideas, technologies and skills for building prosperity, growth, health and sustainability. It serves governments, industries, business and communities across the nation.