

Official mortality data for England reveal systematic undercounting of deaths occurring within first two weeks of Covid-19 vaccination

Clare Craig¹, Martin Neil², Norman Fenton², Scott McLachlan², Joel Smalley¹, Josh Guetzkow³, Jonathan Engler¹, Dan Russell¹ and Jessica Rose⁴

3 March 2022

Abstract

The accuracy of any data purporting to show covid 19 vaccine effectiveness or safety is critically dependent on the accuracy of four measurements: (1) people classified as having the disease; (2) vaccination status; (3) reported deaths; and (4) the population of vaccinated and unvaccinated (the so called 'denominators'). Errors in any of these could undermine claims of vaccine effectiveness or safety. We have previously identified anomalies in the UK Government's ONS deaths by vaccination status data (ONS dataset) - specifically that some deaths occurring shortly after vaccination are being wrongly classified as unvaccinated deaths. In this paper we identify a further problem that appears to explain anomalies in the ONS data: the total deaths reported by ONS are significantly lower than we would expect compared to other government datasets, even allowing for the fact that the ONS use only a subset of the population. For both non-covid and covid deaths respectively the number of deaths reported for the *within 21 days of first dose* vaccination category tally almost perfectly with the number of deaths that would be expected should they have occurred in the third week alone. Thus, for both covid and non-covid deaths, the two weeks of post first vaccination deaths appear to have been omitted from the ONS dataset. This pattern is repeated in all age groups over 60. A variety of factors could have led to deaths in the first 14 days being omitted in the ONS dataset, including miscategorisation, reporting lags and data handling or transcription errors. The dataset is therefore corrupted, making any inferences about vaccine efficacy or safety that are reliant on the data, moot. Accordingly, the ONS should publicly withdraw their dataset and call for the retraction of any claims made by others that are based upon it.

1. Introduction

The UK Government has been significantly better than most countries in providing detailed data on Covid cases and deaths indexed by vaccine status. However, despite these efforts we revealed a range of fundamental inconsistencies and flaws in ONS mortality data [1]. Specifically, two of the most recent UK ONS (Office for National Statistics) vaccine mortality surveillance reports [2, 3] reveal a range of fundamental inconsistencies and anomalies in the data. Analysis of these identified the most likely explanations for the observed anomalies are a combination of four possibilities: (1) systemic miscategorisation of deaths between the different categories of unvaccinated and vaccinated; (2)

¹ Independent researcher, UK

² School of Electronic and Electrical Engineering and Computer Science, Queen Mary, University of London, UK

³ Hebrew University Jerusalem, Israel

⁴ Institute of Pure and Applied Knowledge, Public Health Policy Initiative, USA

delayed or non-reporting of vaccinations; (3) systemic underestimation of the proportion of unvaccinated; and/or (4) incorrect population selection for Covid deaths.

In this paper we focus on a newly discovered and alarming source of bias or potential corruption in the ONS February 2022 report which provides the reported deaths after vaccination data for the whole of 2021 [4]. Specifically, this report reveals systematic undercounting of both covid and non-covid totalled deaths occurring within the first two weeks of Covid-19 vaccination. This bias can be detected by simply comparing the mortality rate we would expect historically, as published by the ONS, with the mortality rates published in the ONS dataset for 2021, for non-covid deaths. For covid deaths the bias is evident when we compare the published covid deaths for England as a whole against those in the ONS dataset [4].

The scale of undercounting is such that, we estimate, it is equivalent to the number of deaths that would have been expected to have occurred within the two-week period immediately after vaccination. Only those deaths that occurred during the third week post vaccination match historical expected non-covid death counts and concurrent covid death counts. This is true across the age groups 60-69, 70-79 and 80+. It was not possible to compare deaths in the period after second vaccination as these have only been released monthly rather than by week, and the ONS have not released whole population data for deaths by month with an age breakdown.

Additionally, we compared the population in the ONS dataset and the UKHSA vaccination dataset, NIMS (National Immunisation Management System) [8] and found evidence that the population that appears in the ONS dataset is missing millions of people categorised as *within 21 days of first dose* vaccination, that are present in the NIMS dataset. The number missing exceeds what would be expected based on the proportion of the whole population not included in the sample. These biases appear to be systematic and cover covid and non-covid deaths.

Likewise, we compared the death counts registered for England in [7] with the ONS dataset and found that 13,593 deaths were missing from the ONS dataset (taking account for the fact that the ONS use only a subset of the population). The mortality rate in the vaccinated and unvaccinated population omitted from the dataset is disproportionately high when compared to historical norms, whilst that reported for the vaccinated are disproportionately low, as previously reported in [1].

In summary, three new key pieces of evidence suggest that the ONS failed to accurately report deaths and omitted deaths that occurred within two weeks of vaccination:

- **Deaths and population data omitted from ONS dataset**

The ONS dataset only represents a part of the population, based on those included in the ONS 2011 census in England and in the GP register. Comparing total deaths in the ONS dataset with those in the whole population shows the mortality rate for those outside of the ONS dataset to be more than double that of those included in the dataset. Unless the population outside the ONS dataset genuinely has a much higher mortality rate, the only explanation is that deaths have been omitted from the ONS dataset, thus 'pulling' the mortality rate down.

- **Non-covid deaths are implausibly low for the group *within 21 days of first dose* vaccination**

The ONS dataset fails to include non-covid deaths that would be expected based on historical mortality rates. Only those non-covid deaths expected, based on historical mortality rates, in the third week after vaccination appear to be included. Deaths that would be expected to occur in the first two weeks appear to have been omitted.

- **Covid deaths are implausibly low for the group *within 21 days of first dose* vaccination**

In the first two months of 2021, the covid mortality rate was higher for those in the *more than 21 days after the first dose* category than for those in the *within 21 days of the first dose* category, which is the reverse of what might be expected. Using the covid mortality rate for the whole population, the category *within 21 days of first dose* suffer far fewer covid deaths than would be expected; the rates are approximately the same as would be expected in the third week after vaccination alone.

Section 2 describes the background, analysis approach, and identifies sources of data. Section 3 examines total population mortality rates and death counts using data excluded from the ONS dataset. Section 4 covers omitted non-covid deaths across all age categories and Section 5 performs the same analysis for covid deaths. Section 6 examines possible explanations for these systematic omissions. Section 7 discusses how vaccination and death data is collected in the myriad NHS systems and identifies potential issues around the ‘chain of custody’ needed to guarantee accuracy of this data and how errors, omissions and problems might occur. Finally, in Section 8 we draw some conclusions.

2. Background

The ONS have been under pressure to release a dataset of deaths after vaccination, most likely with the intent to reassure the public that vaccination had caused no harm. They first promised a release of this data in March 2021 [5] but they did not release any data until six months later [6], after which there have been updates in November 2021 [2], December 2021 [3] and February 2022 [4].

A thorough investigation of the rise in non-covid mortality of the unvaccinated which coincides with peak vaccine rollout in each separate age category has been shown to be compatible with a data lag or data miscategorisation [1]. Some (including ONS themselves) claimed the explanation was a “healthy vaccinee” effect. However, as shown in [1], this healthy vaccinee effect is not supported by the data for two reasons. First, because the proportion of the unvaccinated population considered to be in poor health fell during the vaccination rollout and remained low even after the unvaccinated population fell to only a small number. Second, the same spike in mortality in the unvaccinated was observed when looking only at deaths of those in very poor health.

An analysis comparing those in the ONS dataset to the population as a whole, has been undertaken. By combining data from other data sources, including ONS data on total weekly registered death counts [7], and from the UKHSA NIMS data on numbers vaccinated [8], the mortality pattern in the whole population of England can be estimated and compared against the ONS dataset. First, the ONS dataset can be compared to the UKHSA data on vaccinations and the differences uncovered can be used to estimate the size of the vaccinated population that has been excluded from the ONS dataset. Secondly, taking the difference between the deaths in the ONS dataset and the ONS publication for covid and non-covid deaths in England and Wales [7], prorated to the population of England only, gives an estimate of the total number of deaths excluded from the ONS dataset. Studying the death and population estimates excluded from the ONS dataset reveals a radically different mortality pattern than that provided by the ONS dataset in isolation. Details of the methods used are listed in the Appendix.

3. Mortality rate in excluded population disproportionately high

The ONS dataset is a carefully selected large sample of the whole population; it is restricted to people in England who were both included in the 2011 census and registered with a GP in 2019. However, it can be compared with other mortality datasets published by the ONS for the whole population. It is therefore possible to compare the mortality rate for people included in the dataset with the rate for

those not included in the dataset. For the 80+ age group included in the ONS dataset up to 26th March 2021, 1% of the population had a covid-attributed death. Using other official data sources, total deaths [7] as reported by the ONS and the ONS’s own total population estimate [9], 2% of the English 80+ population, not included in the ONS dataset, had a covid-attributed death. So, the reported mortality rate for those not included by the ONS is twice as high as for those included. The only possible explanations for this are either that: (i) deaths have been omitted from the dataset; (ii) the population is twice as large as the ONS estimated; or (iii) the mortality rate is genuinely twice as high for the residual population not included in the ONS dataset. There is no reason to believe the latter two explanations are plausible.

The total deaths included each week in the ONS dataset can be compared to the total registered deaths the ONS have reported for the whole population. As shown in Figure 1, most of the deaths omitted from the ONS dataset occurred in the early weeks of the year, peaking at the beginning of February 2021. A further comparison can be made between the whole population reported by UKHSA as belonging to the *within 21 days of first dose* vaccination category in NIMS and the numbers reported to be *within 21 days of first dose* in the ONS dataset. The population not included in the ONS dataset, belonging to the *within 21 days of first dose* category, correlates very closely with the deaths not included in the ONS dataset, as shown in Figure 1. The rise and fall in this population deficit reflect the period during which people fell into the category of *within 21 days of first dose*.

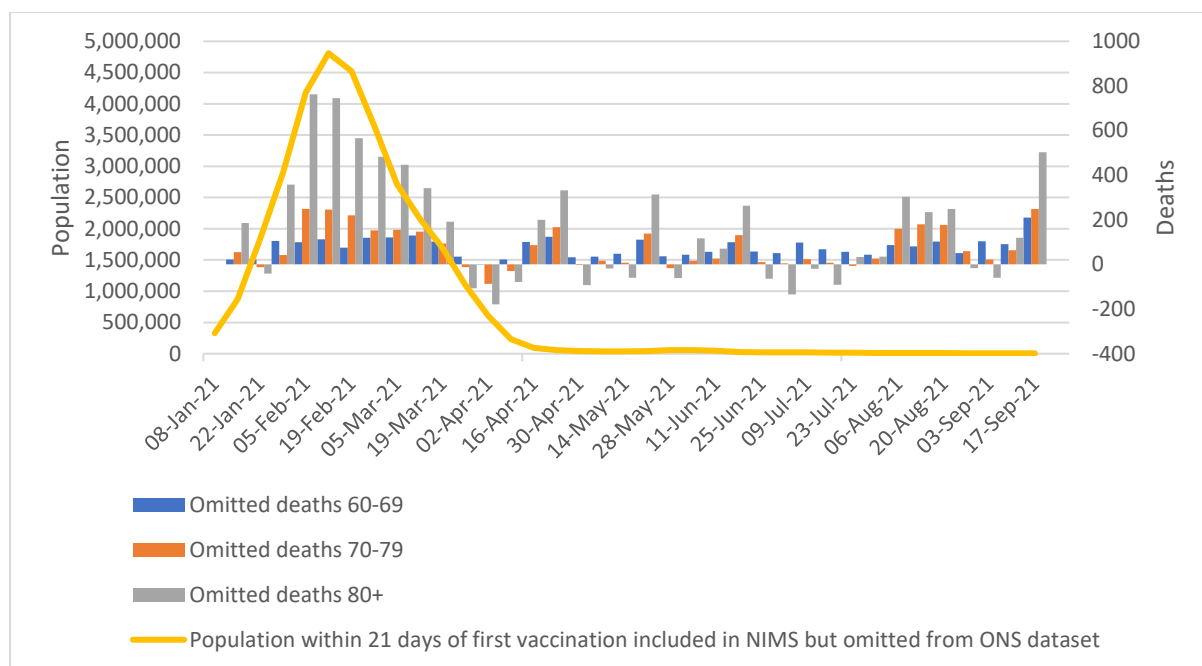

Figure 1: Estimated deaths for England that were not included in the ONS dataset plotted against population in NIMS belonging to the *within 21 days of first dose* category (using a three-week moving average)

4. Implausibly low non-covid deaths for the ‘within 21 days of first dose’ vaccination category

Using historical weekly mortality rates for 2015-2019 we can estimate how many non-covid deaths to expect as a proportion of the population by age. The number of people who were *within 21 days of first dose* vaccination category changed over time but from the population data, included in the ONS dataset each week, an estimate of expected non-covid deaths can be calculated.

Surprisingly, the non-covid deaths reported by the ONS for the *within 21 days of first dose* vaccination was between one third to a half of the number that would be expected using historical mortality rates. This difference is consistent across each age group. This is shown in Table 1.

Age group	Expected	Reported
60-69	3,246	1,106
70-79	7,600	2,783
80+	16,331	7,514

Table 1: Total expected and reported non-covid deaths up to 26th March 2021 for the 'within 21 days of first dose' vaccination category included in the ONS dataset (pro-rated to England population)

Figures 2 to 4 show the weekly non-covid deaths reported in the ONS dataset for those in the *within 21 days of first dose* vaccination category; the non-covid deaths expected for this group as calculated from historical data, and the expected non-covid deaths occurring in the third week alone since first dose vaccination, as calculated from historical data. The proximity of the non-covid deaths reported in the ONS dataset to those expected to occur in the third week alone since vaccination is remarkable. The same pattern occurs across each age category and is highly suggestive that the ONS dataset has not included the non-covid deaths that occurred during the first two weeks post first dose vaccination administered to each age group. This finding is consistent with the hypothesis in [1] that the anomalies found in the ONS data are most likely caused by undercounting deaths occurring shortly after vaccination and that this undercounting was due primarily to misclassification.

Note that, because this is the population *within 21 days of first dose* the peaks are synchronised with the vaccine roll out for each age group and hence are not natural or due to random error.

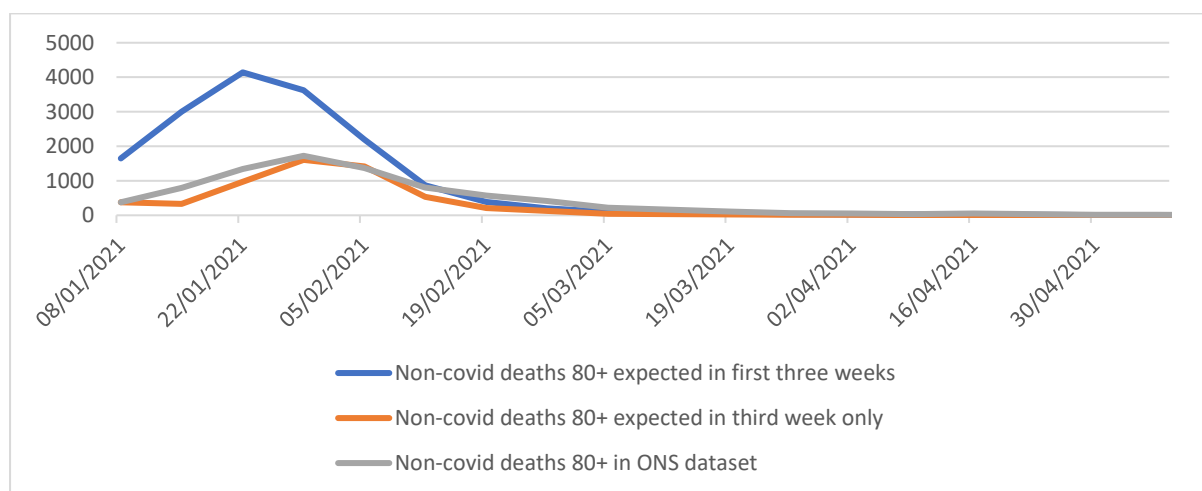

Figure 2: Expected non-covid deaths 21 days after vaccination versus expected non-covid deaths in the third week since vaccination and non-covid deaths included in the ONS dataset for the 80+ age group (to May 2021)

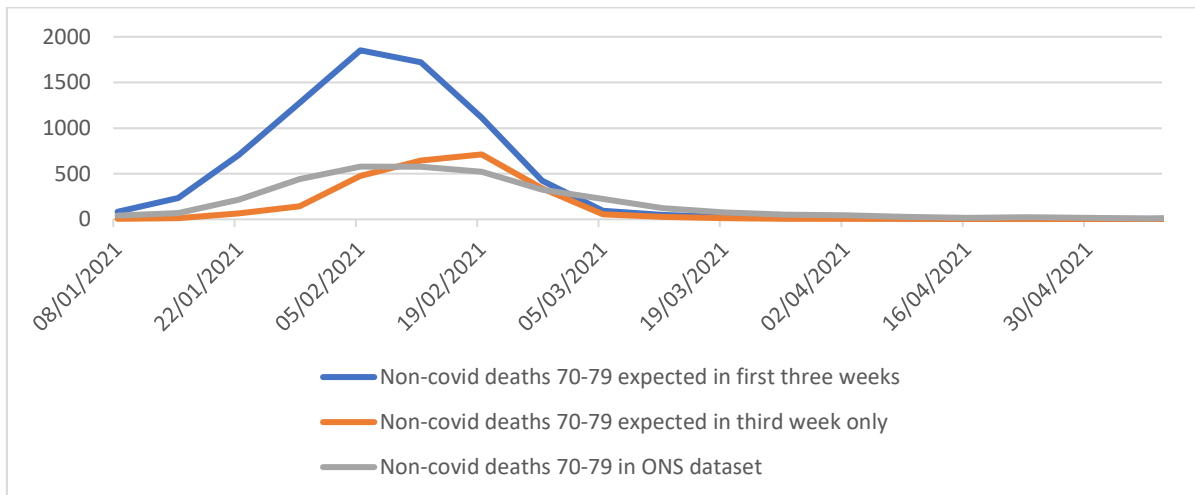

Figure 3: Expected non-covid deaths 21 days after vaccination versus expected non-covid deaths in the third week since vaccination and non-covid deaths included in the ONS dataset for the 70-79 age group (to May 2021)

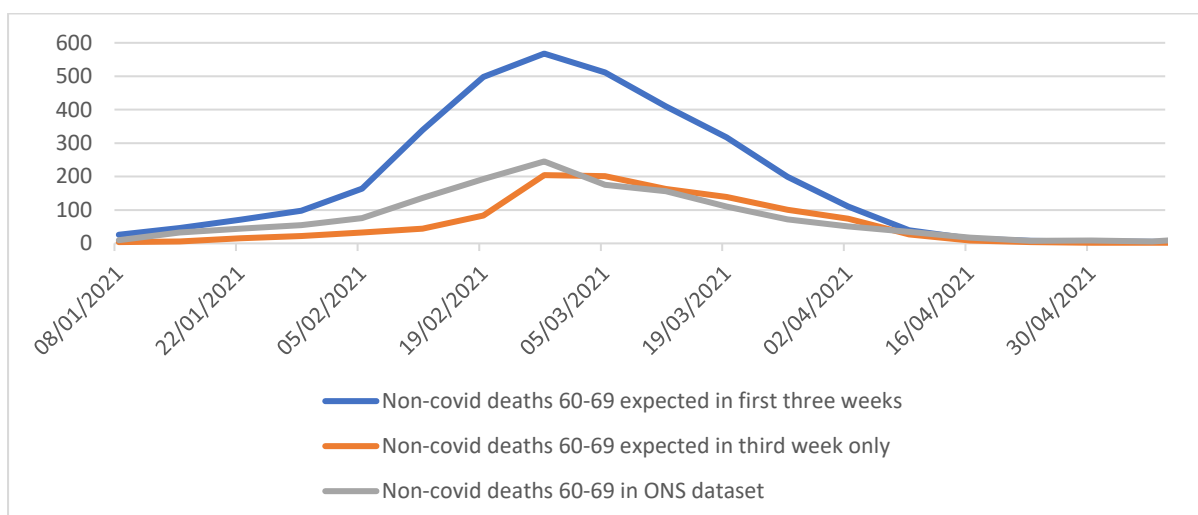

Figure 4: Expected non-covid deaths 21 days after vaccination versus expected non-covid deaths in the third week since vaccination and non-covid deaths included in the ONS dataset for the 60-69 age group (to May 2021)

The healthy vaccinee hypothesis, that those close to death will postpone or decline vaccination might hypothetically account for a lower rate of death in the first two weeks. But as an explanation it is only plausible if every possible death that might occur in the first two weeks, after the offer of vaccination, was foreknown whilst those deaths in the third week were not, and hence those dying in the third week did not postpone or decline vaccination. See Appendix in [1] for further discussion of the implausibility of the assumptions required for the healthy vaccinee hypothesis.

Unfortunately, the same analysis cannot be applied to the group *within 21 days of second* vaccination dose because ONS have only released this data as a monthly value and have not published overall deaths by month with an age breakdown.

5. Implausibly low covid deaths for the *within 21 days of first dose* vaccination category

The vaccine ought to reduce the number of covid deaths but is not thought to be fully effective until two weeks have passed since vaccination. It has been suggested from several studies (cited in [1]) that the vaccinated are vulnerable to covid infection during this period; therefore, the covid mortality rate should – if anything - be higher in the *within 21 days of first dose* vaccination category than in the *more than 21 days after first dose* vaccination category. This is due to increased susceptibility in the first 21 days and possibly correspondingly lower later susceptibility (from immunity acquired after infection) [18]. Yet, conversely, in the first two months of 2021, the covid mortality rate was higher in the *more than 21 days after first dose* vaccination category than in the *within 21 days of first dose* vaccination category.

The covid mortality rate in the *within 21 days of first dose* category can be estimated using a similar approach to that already used to estimate non-covid mortality, using the whole population covid mortality rate, available from other official data. The covid deaths included in the ONS dataset for those *within 21 days of first dose* group is considerably lower than expected, as shown in Table 2.

Age group	Expected	Reported
60-69	1,096	205
70-79	3,312	805
80+	9,906	3,157

Table 2: Total expected and reported covid deaths up to 26th March 2021 for the “within 21 days of first dose” vaccination category included in the ONS dataset (pro-rated to England population)

Figures 5 to 7 show the weekly covid deaths reported in the ONS dataset for those in the *within 21 days of first dose* vaccination category; the covid deaths expected for this group as calculated from concurrent data from other official sources, and the expected deaths occurring in the third week alone since first dose vaccination. The proximity of the covid deaths reported in the ONS dataset to those expected to occur in the third week alone since vaccination is – again – remarkable. The same pattern occurs across each age category and further suggests the ONS dataset has not included the covid deaths that occurred during the first two weeks post first dose vaccination.

The fact that covid deaths occurring during the first two weeks have been omitted from the ONS dataset, in the same manner as non-covid deaths have been omitted is a significant and rather troubling anomaly warranting an explanation.

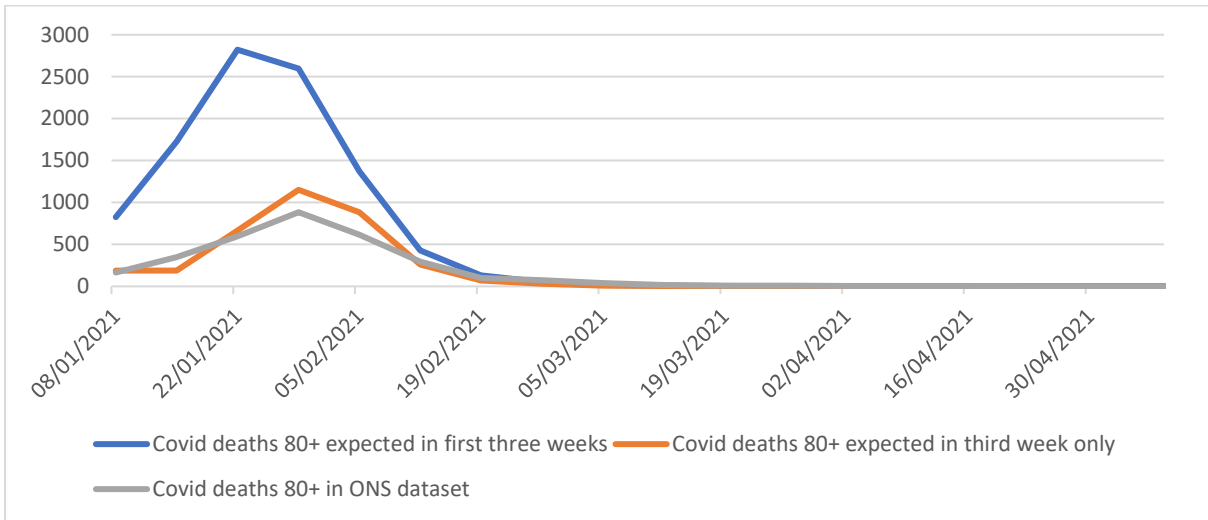

Figure 5: Expected covid deaths 21 days after vaccination versus expected non-covid deaths in the third week since vaccination and covid deaths included in the ONS dataset for the 80+ age group (to May 2021)

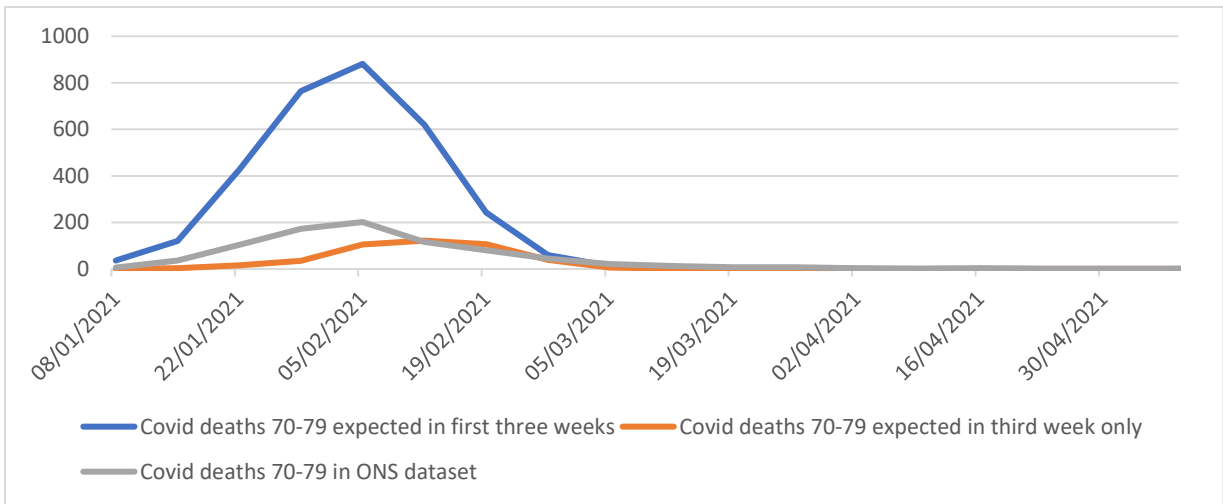

Figure 6: Expected covid deaths 21 days after vaccination versus expected non-covid deaths in the third week since vaccination and covid deaths included in the ONS dataset for the 70-79 age group (to May 2021)

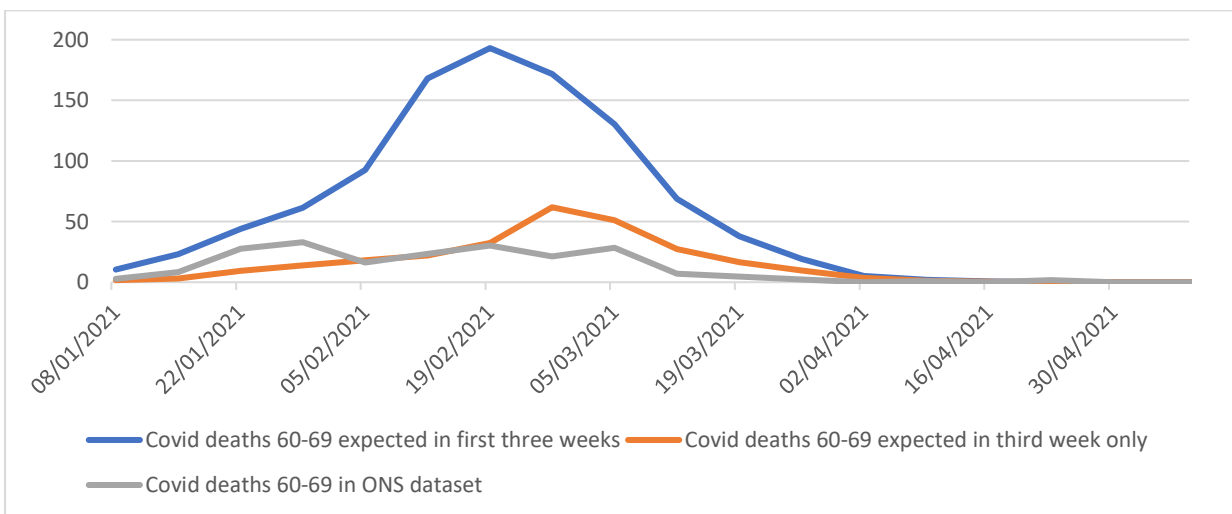

Figure 7: Expected covid deaths 21 days after vaccination versus expected non-covid deaths in the third week since vaccination and covid deaths included in the ONS dataset for the 60-69 age group (to May 2021)

It could be argued that the 18-day average delay between diagnosis and death would mean that the lack of deaths *within 21 days of first dose* might be explained by covid contracted prior to vaccination (it is recommended that vaccination should be postponed if covid positive). However, studies [10, 11] have reported significant numbers of covid infections occurring immediately after vaccination, with numerous reports of around 40% higher incidence in the first two weeks after vaccination than in the unvaccinated [18]. Given the period between infection and death is heavily age dependent, with a much shorter period in the over 60s [21], this explanation is not credible.

6. Alternative explanations for anomalies

The mortality rate is defined as the number of deaths divided by the size of the population, and therefore any inaccuracies in either the number of deaths or the size of the population will produce an inaccurate and misleading result.

The ONS dataset shows a spike in all-cause mortality in the unvaccinated that coincides with the first dose vaccine rollout for each age group [1]. This higher mortality rate seen in the unvaccinated during the vaccination programme has been explained as being caused by these possible phenomena:

1. There is a reporting lag such that deaths are reported a week late. The mortality rate would then be distorted by the shrinking population denominator in the unvaccinated group and the growing population denominator for the vaccinated.
2. Post vaccination deaths have been miscategorised as unvaccinated.
3. There is a “healthy vaccinee” selection bias such that people who are mortally ill are not allowed or decline the offer of vaccination.

The December 2021 publication by the ONS [3] supports the latter hypothesis and stated that:

“The all-cause ASMRs for the year-to-date were lower in the first three weeks after a vaccine dose than in subsequent weeks after that dose. This could be because of a “healthy vaccinee effect” where people who are ill (either due to COVID-19 or another relevant illness) are likely to delay vaccination. Therefore, the people who have been recently vaccinated are, in the short term, in better health than the general population. The same is true for deaths involving COVID-19 after the second dose. This is likely because the healthy vaccinee effect where people who know or suspect they have COVID-19 delay vaccination until recovered, has a bigger effect here than the difference in protection offered by the vaccine within and following the first three weeks after vaccination.”

However, the same report also states:

“Changes in non-COVID-19 mortality by vaccination status are largely driven by the changing composition of the vaccination status groups because of the prioritisation of clinically extremely vulnerable and people with underlying health conditions, and differences in timing of vaccination among people who were eligible.”

These points appear contradictory. If the extremely vulnerable were prioritised for vaccination, how can the clinically vulnerable disproportionately be overrepresented in the unvaccinated group?

The ONS hypothesis relies on two extreme and implausible assumptions:

1. That a terminally ill person, when offered a ‘safe and effective’ vaccine to reduce the risk of a distressing death from respiratory failure, would decline it.
2. The dying, or their carers, can accurately assess their remaining life span and those with only two weeks left to live decline the vaccine. However, those with three weeks to live were vaccinated anyway and then died three weeks later.

The ONS hypothesis also does not fit with real-world experience. There were numerous outbreaks of covid in nursing homes shortly after vaccination leading to many deaths. For example, in Northeast Scotland, Basingstoke, Cornwall, Corby, Renfrewshire [13, 14, 15, 16, 17].

7. Data chain of custody

To track vaccinations three separate reporting processes were set up by the NHS: (1) Using the General Practice Extraction System (GPES) to extract vaccination status from the EMIS system used by General Practitioners (GPs); (2) The Pinnacle system for use in community vaccination sites and those GP clinics not using EMIS and therefore connected into GPES; (3) Immunisation Management System (IMS) and the Commissioning Data Sets (CDS) in large hospitals that are able to transport vaccination status directly into the National Immunisation Management System (NIMS); and (4) the National Immunisation and Vaccination System (NIVS) for use in other hospitals and care homes.

In many community and pop-up vaccination sites, and where access to recording an electronic record was a problem or in the absence of an NHS number [19], details were recorded manually on paper [20]. Many vaccinators have prioritised administration of vaccinations over these administrative requirements and information may often have been electronically uploaded in retrospect. It is not clear whether records were (ever) uploaded when patients died between vaccination and the transfer of these paper record to an electronic equivalent, and even less likely where the patient was vaccinated at one of the community or pop-up centres that were not required to collect identification details where the recipient did not wish to provide them. These issues, along with delays in compiling and transporting data between various database systems as shown in Figure 8, have created the potential for under-reporting of vaccination figures.

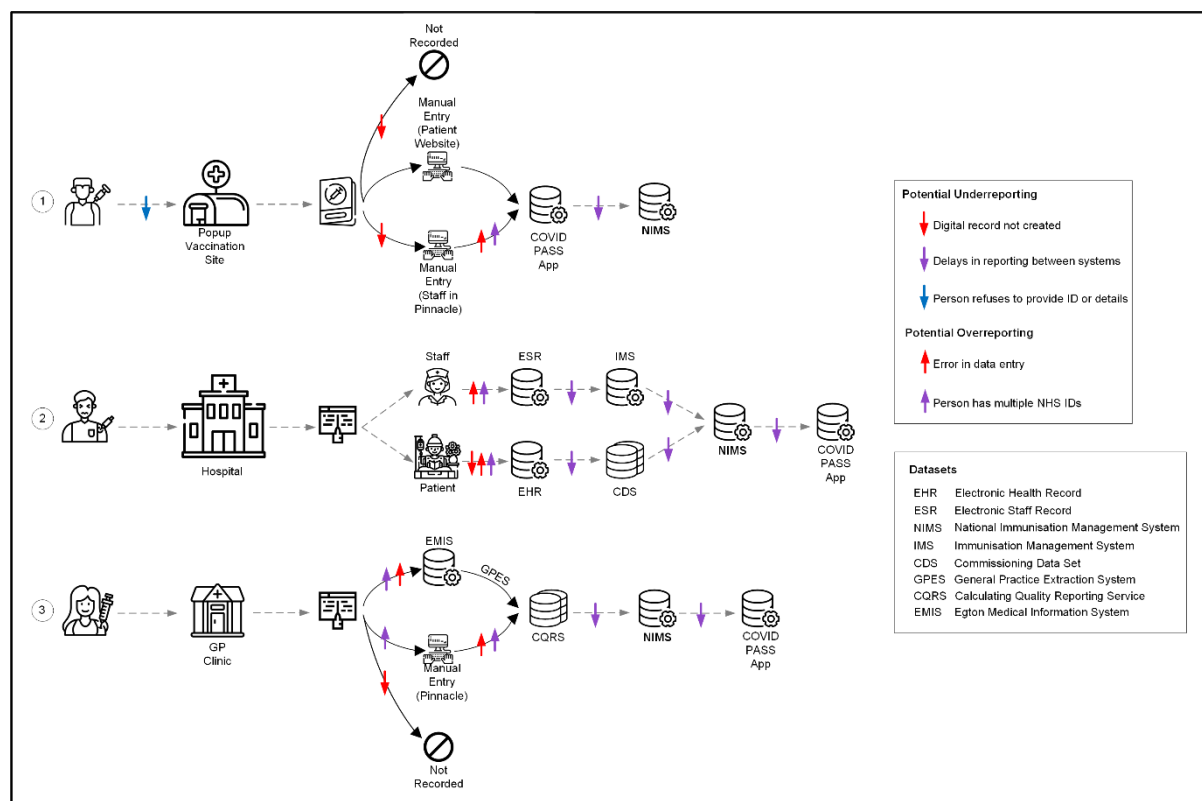

Figure 8: Vaccination record data flow highlighting potential sources of error

Similarly, and again shown in Figure 8, there are situations that have potential for over-reporting. One example has been where: (a) the person was vaccinated at a community centre or pharmacy, where they were not required to collect personal identification data, but in circumstances where the person gave a name only and this was manually entered into the Pinnacle system. In these cases, NIMS creates an NHS number for the 'unknown person' when an NHS record could not be easily 'matched' to them. So, it is possible for a person to have one record with a generated NHS number created for this vaccination at a community centre or pharmacist, and an additional separate record for their vaccination with their GP. They will thus appear to NIMS as separate two people who both received their first vaccinations. We have observed instances where this has occurred, and the person has ended up either being vaccinated an additional time by a GP because the record reported that they hadn't received the 'missing' community injection. There is also the possibility that the GP might enter 'missing' vaccination details from the vaccination card, issued at the community centre or pharmacy, thus creating a third vaccination record in NIMS. Such cases do occur and mean that the NIMS dataset is likely to be very messy. There may also have been issues with patients who had been hospitalised when receiving their first vaccination where there was no record of that first dose on the system. Knowing the proportion of people who experienced issues with the recording of their first dose would be useful to estimate how much of a problem that may have been for records associated with those now deceased.

The ONS are reliant on NIMS data from UKHSA to know who had been vaccinated. The numbers reported as vaccinated each week in NIMS reduces between weekly reports as people are removed from the dataset, having died. The changes to allow for birthdays are less frequent such that the decrease due to deaths is noticeable week to week. Aside from these removals, the week 28 2021 NIMS report from UKHSA shows 12,864 more first doses were given in the first week of the programme than the week 25 2020 report. Since then, rather than this total reducing with deaths, a further 1,000 vaccination records were added more than six months after the vaccination took place. It is not clear whether records for the dead were also added in tandem and whether records were removed after death. Were these all replaced before sharing with ONS? It is critical that all UKHSA shared data included all the deaths that were subsequently removed. Moreover, the NIMS dataset was only made public for the first time in April 2021. It is likely there was immense pressure to release a publication to enable data sharing on the speed of the vaccine rollout. However, for months prior to the first data release, work would have had to be carried out to ensure the database was accurate by removing duplicates and collating data from all the different vaccination sites. It is entirely possible that including those who had died between vaccination and the first release in April 2021 was a low priority and hence the data for those who had died was not accurate. However, this does not explain why the omitted deaths appear to be systematically concentrated in the first two weeks post first vaccination dose.

8. Conclusions

The accuracy of any data purporting to show vaccine effectiveness or safety against a disease is critically dependent on the accuracy of four measurements: people classified as having the disease; vaccination status; death reporting; and the population of vaccinated and unvaccinated (the so called 'denominators'). If there are errors in any of these, claims of effectiveness or safety are unreliable.

The deaths reported in the ONS dataset are significantly lower than expected. There are lower numbers of both non-covid and covid deaths in the first two weeks after vaccination. Those non-covid deaths for the *within 21 days of first dose* vaccination category included in the ONS dataset tally perfectly with the non-covid deaths that would be expected should they have occurred in the third week alone. Thus, the two weeks of post first vaccination non-covid deaths appear to have been

omitted from the ONS dataset. This pattern is repeated for the covid deaths occurring in the same *within 21 days of first dose* vaccination category and again across all age groups.

Total deaths not included in the ONS dataset are disproportionately higher than that expected for the population excluded from the ONS dataset. This suggests deaths have been omitted from the ONS dataset. The fact that total deaths excluded from the ONS dataset correlate with the population of those in the *within 21 days of first dose* vaccination category supports this assertion.

A variety of factors could have led to deaths in the first 14 days being omitted in the ONS dataset, including miscategorisation, reporting lags and data handling or transcription errors. The dataset is therefore corrupted, making any inferences about vaccine efficacy or safety, reliant on the data, moot. The ONS should therefore publicly withdraw their dataset and call for the retraction of any claims made by others that are based upon it.

Acknowledgements

The paper has benefited from the input of senior clinicians and other researchers who remain anonymous to protect their careers.

References

[1] Neil M., Fenton N., et al. Official mortality data for England suggest systematic miscategorisation of vaccine status and uncertain effectiveness of Covid-19 vaccination. January 2022. DOI: 10.13140/RG.2.2.28055.09124

[2] Bermingham C., Morgan J. and Nafilyan V. ONS. "Deaths involving COVID-19 by vaccination status, England: deaths occurring between 2 January and 24 September 2021". 1 November 2021.

<https://www.ons.gov.uk/peoplepopulationandcommunity/birthsdeathsandmarriages/deaths/bulletins/deathsinvolvingcovid19byvaccinationstatusengland/deathsoccurringbetween2januaryand24september2021>

[3] Bermingham C., Nafilyan V., Morgan J., and Ward I. ONS: Deaths involving COVID-19 by vaccination status, England: deaths occurring between 1 January and 31 October 2021: Age-standardised and age-specific mortality rates for deaths involving COVID-19 by vaccination status; deaths occurring between 1 January and 31 October 2021 in England. December 2021.

<https://www.ons.gov.uk/peoplepopulationandcommunity/birthsdeathsandmarriages/deaths/bulletins/deathsinvolvingcovid19byvaccinationstatusengland/deathsoccurringbetween1januaryand31october2021>

[4] Munro M., Bermingham C., Nafilyan V et al. Deaths by vaccination status, England, 1 January to 31 December 2021.

<https://www.ons.gov.uk/peoplepopulationandcommunity/birthsdeathsandmarriages/deaths/datasets/deathsbyvaccinationstatusengland>

[5] Caul S. Tweet from ONS representative about release of data. https://twitter.com/SarahCaul_ONS/status/1368173463383506948?s=20

[6] Bermingham C., Nafilyan V., Morgan J. Deaths involving COVID-19 by vaccination status, England: deaths occurring between 2 January and 2 July 2021. 13 September 2021.

<https://www.ons.gov.uk/peoplepopulationandcommunity/birthsdeathsandmarriages/deaths/articles/deathsinvolvingcovid19byvaccinationstatusengland/deathsoccurringbetween2januaryand2july2021>

1

[7] Caul S. Deaths registered weekly in England and Wales, provisional. 15 February 2022.

<https://www.ons.gov.uk/peoplepopulationandcommunity/birthsdeathsandmarriages/deaths/datasets/weeklyprovisionalfiguresondeathsregisteredinenglandandwales>

[8] UKHSA. Official Statistics – National flu and COVID-19 surveillance reports: 2021 to 2022 season. 17 February 2022.

<https://www.gov.uk/government/statistics/national-flu-and-covid-19-surveillance-reports-2021-to-2022-season>

[9] Park N. Estimates of the population for the UK, England and Wales, Scotland and Northern Ireland. ONS, 25 June 2021.

<https://www.ons.gov.uk/peoplepopulationandcommunity/populationandmigration/populationestimates/datasets/populationestimatesforukenglandandwalescotlandandnorthernireland>

[10] Egan C., Knight S. et al. Hospitalised vaccinated patients during the second wave, update April '21. https://assets.publishing.service.gov.uk/government/uploads/system/uploads/attachment_data/file/982499/S1208_CO-CIN_report_on_impact_of_vaccination_Apr_21.pdf

[11] Bernal et al. Effectiveness of the Pfizer-BioNTech and Oxford-AstraZeneca vaccines on covid-19 related symptoms, hospital admissions, and mortality in older adults in England: test negative case-control study. BMJ 2021; 373 doi: <https://doi.org/10.1136/bmj.n1088> (Published 13 May 2021)

[12] Harrison E. Docherty A and Semple C. COVID-19: time from symptom onset until death in UK hospitalised patients. 7 October 2020.

https://assets.publishing.service.gov.uk/government/uploads/system/uploads/attachment_data/file/928729/S0803_CO-CIN_-_Time_from_symptom_onset_until_death.pdf

[13] BBC News. Covid: Eleven deaths at Aberdeen care home investigated. 11 January 2021. <https://www.bbc.co.uk/news/uk-scotland-north-east-orkney-shetland-55617898>

[14] Basingstoke Gazette. Coronavirus outbreak: 22 deaths at Pemberley House Care Home. 5 January 2021.

<https://www.basingstokegazette.co.uk/news/19043790.coronavirus-outbreak-22-deaths-pemberley-house-care-home/>

[15] Cornwall Live. Eleven residents die in three weeks after care home Covid outbreak. 15 February 2021.

<https://www.cornwalllive.com/news/cornwall-news/eleven-residents-die-three-weeks-5005443>

[16] Northamptonshire Telegraph. Several deaths at Corby care home after mass Covid outbreak. 28 January 2021.

<https://www.northantstelegraph.co.uk/health/coronavirus/several-deaths-corby-care-home-after-mass-covid-outbreak-3115750>

[17] Daily Record. Scots care home residents test positive for Covid-19 days after receiving vaccine. 6 January 2021.

<https://www.dailyrecord.co.uk/news/local-news/care-home-residents-test-positive-23269764>

[18] <https://www.hartgroup.org/it-gets-worse-before-it-gets-better/>

[19] <https://www.ardengemcsu.nhs.uk/media/2152/faqs-nivs-covid-v40.pdf>

[20] <https://www.ardengemcsu.nhs.uk/media/2299/nivs-covid-faqs-v3.pdf>

[21] Harrison E et al. COVID-19: time from symptom onset until death in UK hospitalised patients. October 2020.

https://assets.publishing.service.gov.uk/government/uploads/system/uploads/attachment_data/file/928729/S0803_CO-CIN_-_Time_from_symptom_onset_until_death.pdf

Appendix

Mortality rates

Mortality rates in the vaccinated and unvaccinated population were calculated for each week using the reported deaths divided by the size of the population for each age group and vaccination status within the ONS dataset.

The baseline mortality rates for 2015-2019 were calculated by taking the registered death figures by age, averaged, for each week of the year prorated to England only and dividing by the ONS estimate of the average population over that time in England.

Deaths not included in the ONS dataset

ONS weekly registered deaths for each age group were taken for England and Wales. In order to estimate the number for England alone, the percentage of total deaths each week that occurred in Wales was used to prorate the deaths for each age group. The same method was used to calculate total deaths and covid deaths separately. Non-covid deaths were calculated by taking the difference.

Size of whole population within 21 days of vaccination

The cumulative people vaccinated with a first dose was subtracted from the value for the previous week to give the number of first doses given in each week and the number of people within one week of a first dose. This number was lagged by a week to give the number of people within two weeks and by two weeks for the number within three weeks. The total within one, two or three weeks was summed to give the whole population within 21 days of a first dose.

Expected non-covid deaths

The weekly 2015-2019 mortality rate for England was multiplied by the size of the population of the “within 21 days of first dose vaccination” category, for a given age group, to give the expected number of non-covid deaths within 3 weeks for that age group. The same calculation was carried out for the population three weeks after being vaccinated with the first dose to give expected non-covid deaths in the third week. These expected non-covid deaths were compared to the non-covid deaths reported in the ONS dataset for the group within 21 days of a first dose. This was then prorated to the whole population of England. This was done by dividing by the population included in the ONS dataset and then multiplying by the figure for the whole population that week.

Expected covid deaths

The weekly covid mortality rate for the whole population of England was calculated by dividing the ONS registered covid deaths, prorated to England, by the ONS mid 2020 population estimate for each age group. This mortality rate was then multiplied by the size of the population within 21 days of first vaccination dose category to give the expected number of covid deaths within 3 weeks for that age group. The same calculation was carried out for the population three weeks after being vaccinated with the first dose to give expected covid deaths in the third week. These figures were compared to the covid deaths reported within the ONS dataset for the group within 21 days of a first dose. This was then prorated to the whole population of England. This was done by dividing by the population included in the ONS dataset and then multiplying by the figure for the whole population that week.