

Measuring the Performance of Two Stationary Interrogation Systems for Detecting Downstream and Upstream Movement of PIT-Tagged Salmonids

PATRICK J. CONNOLLY,* IAN G. JEZOREK, AND KYLE D. MARTENS

*U.S. Geological Survey, Western Fisheries Research Center, Columbia River Research Laboratory,
5501A Cook-Underwood Road, Cook, Washington 98605, USA*

EARL F. PRENTICE

National Marine Fisheries Service, Manchester Research Field Station, Manchester, Washington 98353, USA

Abstract.—We tested the performance of two stationary interrogation systems designed for detecting the movement of fish with passive integrated transponder (PIT) tags. These systems allowed us to determine the direction of fish movement with high detection efficiency and high precision in a dynamic stream environment. We describe an indirect method for deriving an estimate for detection efficiency and the associated variance that does not rely on a known number of fish passing the system. By using six antennas arranged in a longitudinal series of three arrays, we attained detection efficiencies for downstream- and upstream-moving fish exceeding 96% during high-flow periods and approached 100% during low-flow periods for the two interrogation systems we tested. Because these systems did not rely on structural components, such as bridges or culverts, they were readily adaptable to remote, natural stream sites. Because of built-in redundancy, these systems were able to perform even with a loss of one or more antennas owing to dislodgement or electrical failure. However, the reduction in redundancy resulted in decreased efficiency and precision and the potential loss of ability to determine the direction of fish movement. What we learned about these systems should be applicable to a wide variety of other antenna configurations and to other types of PIT tags and transceivers.

In tracking an individual fish's growth, survival, habitat use, and response to environmental changes, the use of passive integrated transponder (PIT) tags has large potential and appeal (Prentice et al. 1986, 1990; Peterson et al. 1994; Juanes et al. 2000). These tags do not rely on a battery for power and can uniquely identify individual fish throughout their life span, which can be 10 years or more for some species. Because of these and other attributes, PIT tags have become a primary tool for monitoring juvenile salmonid migration timing and for estimating survival past hydroelectric dams in the Columbia River system (Achord et al. 1996; Skalski et al. 1998; Muir et al. 2001a, 2001b; Zabel and Achord 2004). Similarly, much new information on fish movement, timing, and behavior has been gained by placing PIT tag interrogation systems in streams to detect passing fish (Armstrong et al. 1996; Zydlewski et al. 2001, 2006; Riley et al. 2003). The use of these systems in experimentally controlled settings has provided researchers with a new tool for understanding fish behavior (Nunnallee et al. 1998; Armstrong et al.

1999; Greenberg and Giller 2000; Riley et al. 2002). A stationary system in free-flowing streams has promise to detect passing fish for continuous periods of time and during times too difficult to sample by conventional means, such as during high flows and ice cover (Greenberg and Giller 2000; Roussel et al. 2004).

If information on population estimates, survival, or the proportion of fish exhibiting a certain behavior is desired, the efficiency and variability of detecting tagged fish need to be determined (Horton et al. 2007). Following Zydlewski et al. (2006), we did not distinguish between the terms "efficiency" and "probability," and we adopted the term "efficiency" to describe overall performance of a system for detecting passing fish with PIT tags. What we define as "detection efficiency" is the percentage of PIT-tagged fish that were detected when and if they passed an interrogation system. Estimation of detection efficiency so defined does not rely on knowing the number of fish that were tagged in the population. Zydlewski et al. (2006) described the major components ("path efficiency" and "antenna efficiency") influencing the detectability of a PIT-tagged fish that passes an array with one or multiple antennas. What we refer to as "detection efficiency" is the combination of these major components. Relatively few investigations have

* Corresponding author: pconnolly@usgs.gov

Received January 11, 2007; accepted October 11, 2007
Published online March 13, 2008

been performed to determine the efficiency of interrogation systems for detecting PIT-tagged fish. When studies have been done, they have generally used fish that have a high propensity to move downstream or upstream in relative unison during some part of their life history. Efficiency has been calculated for stationary interrogation systems using downstream traps to confirm that fish have passed an interrogator, or by having a known number of fish tagged upstream of a detector and then assuming all emigrate past the interrogator.

There have been substantial efforts to document efficiency using experimental channels and dam facilities. Nunnallee et al. (1998) evaluated efficiency of a PIT tag interrogation system in a fish collection channel using a direct method whereby a known number of fish passed the detector, and by an indirect method whereby detections at other antennas were compared with detections at the system being evaluated. They calculated efficiencies for detecting PIT-tagged salmonids to be 97% using the direct method and 99% using the indirect method. Using similar direct and indirect methods, Axel et al. (2005) found detection efficiencies of a four-antenna system around a large bypass pipe (91.4 cm diameter) to be close to 100% for tagged salmonids. In an experimental fishway study, Castro-Santos et al. (1996) used four arrays of one antenna each and found the detection efficiencies for three clupeid species known to have passed their detector system to be 96% in a Denil-type fishway and 88% in a Steeppass-type fishway. In a study of juvenile Atlantic salmon *Salmo salar* in an artificial channel off the River Itchen in the United Kingdom, Riley et al. (2002) found detection efficiency of downstream-moving fish to be 70%, but detectors at each of three exit points (two exit points had two antennas, one exit had one antenna) were combined to determine an overall efficiency rate. Though upstream movement was detected, they were not able to calculate efficiency for upstream-moving fish. Using captures of fish at a trap downstream of a detection site (two 4-m \times 1.2-m, side-by-side upright antennas), Zydlewski et al. (2001) found downstream detection efficiency to be 93% for juvenile Atlantic salmon. For cases when a known number of fish have passed an interrogator, Zydlewski et al. (2006) described a method for calculating the detection efficiency, but not the variance. In general, these findings indicate that stationary interrogation systems have potential to be highly effective in modified channel systems, but alternate methodologies for estimating detection efficiency and its variability have been lacking.

In most of the previous studies referred to above, detector systems were placed where flow was restricted

by pipes or fishways or at stream pinch points such as bridges or culverts. In some cases, researchers have modified the stream channel to force fish through or near antennas (Greenberg and Giller 2000; Riley et al. 2003; Zydlewski et al. 2006). While it may be possible to direct all water and fish at specific sites, we saw the need to develop an interrogation system that could be adapted to free-flowing streams in remote locations without reliance on existing structures (e.g., culverts and bridges) or modifying the channel.

Despite attempts to direct fish past instream PIT tag antennas, tag detection efficiency is likely to be less than 100% for a number of reasons. Fish behavior can change with changes in stream conditions, and alternate passage routes can provide fish opportunities to pass beyond a detection field. The electrical properties of a PIT tag interrogation system can change with changes in water level, which may partially or completely expose an antenna to air, and with changes in water temperature, conductivity, and air temperature. These changes can compromise a system's ability and consistency to detect tags. However, this latter problem can be partially or completely solved by using transceivers that automatically change their settings (self tune) to changing environmental conditions, thus improving performance. A system's ability to read tags can also be compromised by ambient electromagnetic fields (EMFs) of similar frequency, which can be generated by nearby power lines, electric fences, pumps, or electrical devices in homes or businesses (Zydlewski et al. 2006). This interference can be steady or changing depending upon the noise source (Horton et al. 2007). Because the present systems cannot read two tags at once, multiple fish swimming through or holding in the detection field at the same time can compromise the ability to detect a tag (Greenberg and Giller 2000). Because of these and possibly other factors, investigators may need to determine detection efficiencies during discrete periods of differing conditions (Horton et al. 2007).

The objectives of our study were to (1) describe a protocol for identifying active juvenile and adult salmonid migrants, (2) estimate the magnitude and variance of detection efficiency, (3) evaluate the effect of the direction of fish movement and stream flow on detection efficiency, and (4) explore the effect of antenna configuration on detection efficiency. We describe the tag-reading efficiencies, with estimates of variability, achieved by two similar PIT tag interrogation systems designed to (1) maximize detection of tagged fish, (2) distinguish between downstream and upstream movements, (3) be readily adaptable to remote stream sites, and (4) not be dependent on full-stream coverage. We describe an indirect method for deriving



FIGURE 1.—Locations of Rattlesnake and Beaver creeks, where PIT tag interrogation systems were evaluated.

the overall efficiency of detection predicated on having at least two antennas in an upstream–downstream location. Because our PIT-tagged populations of fish were not all actively migrating fish, we developed a protocol with criteria to maximize inclusion of actively migrant fish and to minimize inclusion of fish exhibiting partial passage behavior. The information we present about these systems should serve as a guide for future designs and should be relevant to a wide variety of other equipment (e.g., other kinds and sizes of PIT tags, and other methods that mark and recapture individually identified fish).

Study Area

We tested the efficiency of our instream PIT tag interrogation systems in two streams. Both streams are located within the Columbia River basin, with Rattlesnake Creek in south-central Washington's White Salmon River watershed and Beaver Creek in north-central Washington's Methow River watershed (Figure 1).

Rattlesnake Creek is a third-order stream that drains westward into the White Salmon River at river kilometer (rkm) 13.8 (near Husum, Washington), which in turn enters the Columbia River at rkm 271. The Rattlesnake Creek watershed is 143 km² and ranges in elevation from 114 to 927 m. The antennas were placed in a stream section about 30 m long and consisting of medium gradient riffle and pocket water. Wetted width varied from 4.5 to 14 m. Bankfull width averaged 9 m at the antenna sites. Base flow thalweg depth at the antennas was 18–28 cm. The substrate was primarily large cobble and small boulder (15–80 cm diameter). The salmonids in this stream included rainbow trout *Oncorhynchus mykiss* and coastal cutthroat trout *O. clarkii*.

Beaver Creek is a third-order stream that drains westward into the Methow River at rkm 57 (just south of Twisp, Washington), which in turn enters the Columbia River at rkm 843. The Beaver Creek watershed is 179 km² (USFS 2004) and ranges in elevation from 463 to 1,890 m. The antennas were deployed in a stream section about 24 m long and consisting of the tail-out of a shallow pool and low gradient riffle. Wetted width varied from 5.3 to 6.2 m. Bankfull width averaged 9 m at the antenna sites. Base flow thalweg depth at the antennas ranged from 5 to 39 cm. The substrate was primarily gravel and cobble. The stream supported both anadromous salmonids (primarily steelhead [anadromous rainbow trout] but also Chinook salmon *O. tshawytscha* and coho salmon *O. kisutch*) and nonanadromous salmonids (westslope cutthroat trout *O. clarkii lewisi*, bull trout *Salvelinus confluentus*, and brook trout *S. fontinalis*).

Methods

As part of larger studies, we PIT-tagged fish in Rattlesnake and Beaver creeks to investigate their life histories, habitat use, and response to restoration. For comparisons of PIT tag detection efforts in Rattlesnake Creek and Beaver Creek watersheds, we used fish that were inserted with 12.5-mm-long × 2.1-mm-diameter, full-duplex PIT tags (134.2 kHz). The small size of these tags allowed tagging of juvenile salmonids with fork lengths as small as 70 mm. Another important reason we used these particular tags is that the PIT-tagged fish could be detected at other existing interrogation systems throughout the Columbia River basin, including many of the main-stem dams (Muir et al. 2001a; Axel et al. 2005; Burke and Jepson 2006).

Tagging in Rattlesnake Creek.—From 2001 to 2005, we tagged 4,255 rainbow trout and cutthroat trout (fork length [FL]: range = 70–415 mm, mean = 125 mm, median = 118 mm, SD = 34.2) in the Rattlesnake Creek watershed. Most of these fish were PIT-tagged within the 1.1 km of Rattlesnake Creek upstream of the detector site, although some were tagged up to 14 km upstream. We also tagged 356 trout (FL: range = 82–490 mm, mean = 213 mm, median = 204 mm, SD = 68.8) in the 3-km section of the White Salmon River downstream from the Rattlesnake Creek confluence. Rainbow trout ($n = 4,062$) made up the majority of the tagged trout (88%). Trout in Rattlesnake Creek were captured by electrofishing during spring, summer, and fall. Trout in the White Salmon River were captured primarily by angling during summer, with some captured by electrofishing. All tagging was done by hand following protocols outlined by the Columbia Basin Fish and Wildlife Authority (1999).

Because PIT tag technology advanced during our

Rattlesnake Creek project, we used three tag models produced by Digital Angel Corporation: BE ($n = 1,343$) at the beginning, ST ($n = 2,566$) in the middle, and SGL ($n = 702$) at the end of the study. Each subsequent tag had better read ranges than the former. At low EMF noise levels and optimum orientation, the ST model had up to 42% better read range than the BE tag (Peterson Engineering Services 2002), and the SGL tag had up to 9.3% better read range than the ST tag (Downing et al. 2005). As stated by Zydlewski et al. (2006), these increases in read range are relatively small compared with what would be expected from the use of the next larger size of PIT tag (i.e., 23 mm in size).

Tagging in Beaver Creek.—A total of 3,913 rainbow trout, steelhead, and brook trout (FL: range = 65–760 mm, mean = 120 mm, median = 115 mm, SD = 52.9) were PIT-tagged (1,672 ST tags and 2,241 SGL tags) in the Beaver Creek watershed in 2004 and 2005. Juvenile steelhead and rainbow trout ($n = 3,230$) made up the majority of the tagged fish (79%). We used electrofishing gear to collect fish throughout the watershed of Beaver Creek and a two-way fish trapping weir located at rkm 1. Most of the electrofishing occurred during the summer, spring, and fall. The weir was operational from 22 October through 22 December in 2004 and from 20 March through 5 December in 2005.

Installation and configuration of interrogation systems.—In both Rattlesnake and Beaver creeks, we installed a custom-made PIT tag interrogation system to monitor fish movement. We needed a system that could be deployed in a natural section of stream, could distinguish between downstream and upstream movements, and would not need daily attention like a weir or trap. Each interrogator had six antennas arranged in three arrays of two antennas each (i.e., a 3×2 design). When a tag was detected, these systems provided information on what antenna it was read on and the date and time that the detection occurred.

The PIT tag interrogation system in Rattlesnake Creek was installed at rkm 0.2, just upstream of its confluence with the White Salmon River. Although some antennas were installed in August 2001 (Connolly et al. 2005), it was not until 2003 that we acquired a multiplexing transceiver, Digital Angel's Model FS1001M, capable of autotuning and operating up to six antennas. Subsequently, we designed and installed an interrogation system with three arrays of two antennas each. The antennas were systematically numbered in a successively downstream manner, river left to river right (Figure 2). The transceiver was located in a weatherproof housing near the stream. The FS1001M transceiver operated on 24-V DC power.

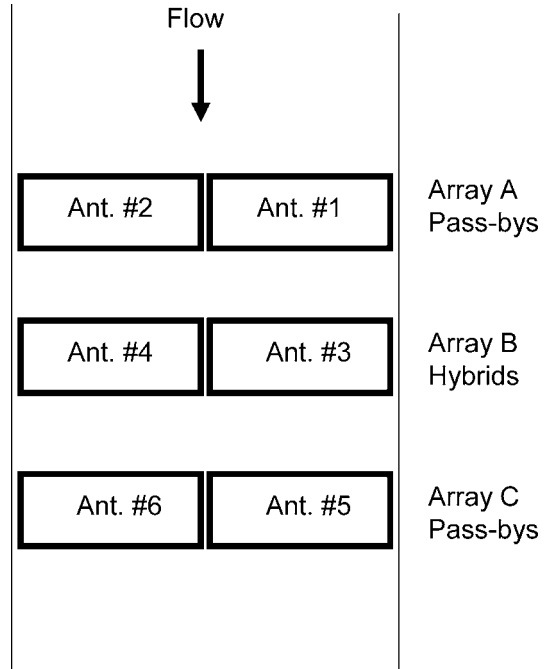

FIGURE 2.—A conceptual diagram of the three-array, six-antenna PIT tag interrogation system used in Rattlesnake and Beaver creeks. Pass-by antennas were anchored to the substrate at all four corners; hybrid antennas (Ant.) were anchored on the upstream side so that the downstream side could pivot up in the water column.

This power was provided by a 24-V AC-to-DC linear power supply, which was connected to grid power. Antennas were constructed with polyvinyl chloride (PVC) pipe to create rectangular shapes that varied in length and width. The antennas (numbers 1 and 2) in the upstream-most array (array A) each measured $3.1 \text{ m} \times 0.6 \text{ m}$. The middle array (array B) had a river left antenna (number 3) that measured $3.1 \text{ m} \times 0.6 \text{ m}$ and a river right antenna (number 4) that measured $2.0 \text{ m} \times 0.8 \text{ m}$. The downstream-most array (array C) had a river left antenna (number 5) that measured $3.1 \text{ m} \times 0.6 \text{ m}$ and a river right antenna (number 6) that measured $2.0 \text{ m} \times 0.8 \text{ m}$. By varying the lengths of the antennas, we were able to span most of the low-flow wetted width, thalweg, and one stream bank with a single antenna, and by adding a second antenna, we were able to include all or some of the stream's bank-full width.

We used two methods to attach the antennas to the substrate to maximize the detection of PIT-tagged fish and the probability that the antennas would function during a dynamic range of stream flows. Antennas within the upstream-most (array A) and downstream-most (array C) arrays (Figure 2) were attached at all

four corners directly to the stream substrate, and thus they were horizontal to stream flow. This orientation differs from Zydlewski et al.'s (2006) "swim-through" antennas and from Armstrong et al.'s (1996) and Greenberg and Giller's (2000) "flat plate" design. We refer to this antenna orientation as "pass-by." We prefer this generic term, rather than "swim-by," because the use of these antennas are applicable to other PIT-tagged animals and objects that may or may not swim (e.g., tagged rocks for streambed movement studies). While a tagged fish could pass over or under a pass-by antenna, it could also weave through the opening within the rectangular frame of the antenna. In array B of our interrogation systems, we used two so-called "hybrid" antennas capable of pivoting in the water column as depth increased. These hybrid antennas had only the upstream side of the antenna attached to the substrate at two or more pivot points, thus enabling the downstream side of the antenna to float in the water column. As water depth changed, the antenna changed its angle in the water column in reference to its attached upstream side. This hybrid antenna was often in a "pass-through" orientation (i.e., vertical to the flow), but would be in a pass-by position during extremes of low flow because of lack of water to float the downstream edge, and during extremes of high flow because high velocity forced the floating edge downward.

Fiber optic cables were installed for data transfer from the transceiver to a computer housed in an existing building on site. The computer recorded detection data using the MiniMon program available through the Pacific States Marine Fisheries Commission (PSMFC, Portland, Oregon). MiniMon configured the data to a format for loading into a regional database (PTAGIS) maintained by PSMFC. We queried the PTAGIS database for detection data that were to be used in subsequent analyses.

In September 2004, we installed a similar PIT tag interrogation system in Beaver Creek. A site was selected where three antenna arrays could be placed within 30.5 m of the transceiver and where two antennas would span the wetted width at most flows. The antennas were placed in the tail-out of pools and in shallow riffle areas. We tied the antennas to metal stakes driven vertically into the streambed, which consisted of cobble and gravel. At the upper most array (array A), we installed a 1.8-m \times 0.9-m antenna (number 1) on river left and a 3.1-m \times 0.9-m antenna (number 2) on river right (Figure 2). At the middle array (array B) we installed two 3.1-m \times 0.9-m antennas (numbers 3 and 4), and for the downstream array (array C) we installed two 1.8-m \times 0.9-m antennas (numbers 5 and 6). As described previously

for Rattlesnake Creek, arrays A and C were anchored to the stream on all four corners in a pass-by configuration while array B was installed in a hybrid configuration. A Digital Angel FS1001M transceiver was used to operate the six antennas. This transceiver was attached to a bank of four 12-V batteries to provide 24-V DC power to the transceiver. The batteries were exchanged on a regular basis (about every 5–7 d depending on factors such as ambient weather and transceiver settings). In addition, a hand-held computer was used to record the data from the transceiver using a Mobile Monitor program (available through PSMFC). All equipment was installed in a 1.2-m \times 1.2-m box placed underground to decrease exposure to high heat and excessive cold.

Detection efficiency calculations.—We evaluated the interrogators' detection efficiencies over the biologically important increments of low- and high-flow periods while differentiating between upstream and downstream movement. Depending on the tuning and power setting of the transceiver and the particular antenna, the read distance above the pass-by antennas for a 12.5-mm, 134.2-kHz ST PIT tag ranged up to 45 cm. Under normal operating conditions, any tag passing through the rectangular openings of the hybrid antennas had the potential to be read by the interrogator, but factors such as tag orientation (Zydlewski et al. 2006) and the presence of another tag (Greenberg and Giller 2000) could decrease this potential. When tag-reading ability dipped below 10 cm from a pass-by antenna or when a tag was not read passing through a hybrid antenna, we modified or replaced the antenna. The incremental change in the interrogation system's efficiency when an individual antenna's tag-reading ability changed was not evaluated. To do so would not likely mimic a practical field practice for most applications.

The PIT tag interrogation system operated almost continuously from 4 November 2003 to 6 October 2005 in Rattlesnake Creek and from 27 September 2004 to 15 May 2006 in Beaver Creek. The detection data were used to calculate detection efficiencies of the individual interrogation systems. The data were sorted into upstream- and downstream-moving fish based on time of detection at two or more arrays. If a fish was detected at a single array, it was often possible to determine direction of movement based on the location of its last detection (i.e., upstream or downstream of the interrogation system).

To distinguish between low and high flow, we used stage-discharge relationships and information about the read ranges of the PIT tags. In each stream, stage-discharge data were available from gauges just upstream of the PIT tag interrogator. In Rattlesnake

Creek, we divided low and high flow at a depth of 16 cm over the top of the most embedded antenna (equivalent to a stage height of 1.48 m and a flow of 0.38 m³/s). This depth corresponded to the maximum read distance for BE-type PIT tags (the weakest tag used in the watershed) at low EMF noise levels and optimum orientation. In Beaver Creek, we reasoned that low flow should be categorized as 22.9 cm or less from the top of the most embedded antenna (equivalent to a stage height of 1.69 m and a flow of 0.57 m³/s), which was based on the water column height that corresponded to the readable range of ST-type PIT tags (the weakest tag used in the watershed) at low EMF noise levels and optimum orientation for all six antennas. While this method to separate low flow and high flow based on water depth and read distance of the weakest PIT tag type increased assurance that equal probability of reading tags was achieved during periods of low flow, it did not assure it for periods of high flow, and it did not incorporate enhancements for orientation and EMF noise issues that later tags incorporated.

To help separate the events in which a fish was likely to have moved past the entire interrogation system from those when a fish did not complete the passage (Figure 3), we developed criteria to select events suitable for use in efficiency calculations (Table 1). Based on the frequency of time to pass the system, we selected a

TABLE 1.—Rules for determining when the detection of a PIT tag qualifies as a fish-detection event and a fish-passage event for the purpose of estimating the probability of detecting a fish passing a PIT tag interrogation system composed of three arrays with two antennas in each array.

1. Eliminate detections of PIT tags in fish that were captured, tagged, and released within 50 m of the antennas.
2. When a fish is detected at only one array, assume that it passed all three arrays but was not detected at the other two.
3. If a PIT-tagged fish is detected at more than one antenna and the time between the first and last detections does not exceed 18 min, treat it as a fish-detection event. (The 18-min value corresponds to the 90th percentile of all potential fish-detection events for the Rattlesnake Creek interrogation site.)
4. If the direction of movement cannot be reasonably determined from previous or later detections, do not use the detection event.
5. If a fish-detection event meets all of the criteria above, treat it as a fish-passage event.
6. Do not use a fish-passage event if the same fish is detected on any antenna 12 h before or after this event.

value of 18 min, which corresponded to the 90th percentile value, to be the time frame within which a fish had to pass the interrogation system. To avoid using fish that were swimming back and forth over the antennas, we eliminated a fish passage event if the same fish was detected by any antenna within 12 h previous or subsequent to the first passage event. When we compared this 12-h criteria (protocol 1) with a much more restrictive criteria of 1 month (protocol 2),

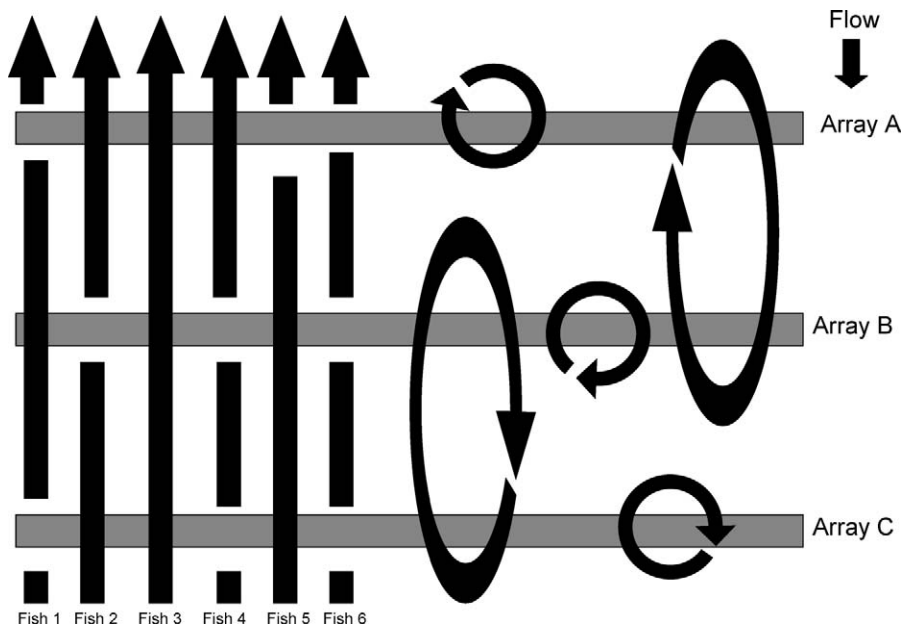

FIGURE 3.—Possible routes and detections of PIT-tagged fish moving across a three-array PIT tag interrogation system. A straight vertical line that crosses a horizontal array line represents a successful fish detection. The movements of fish 1–5 would be classified as fish passage events (see Table 1); that of fish 6 would not. The movements illustrated by the circles and ovals would probably not be considered fish passage events.

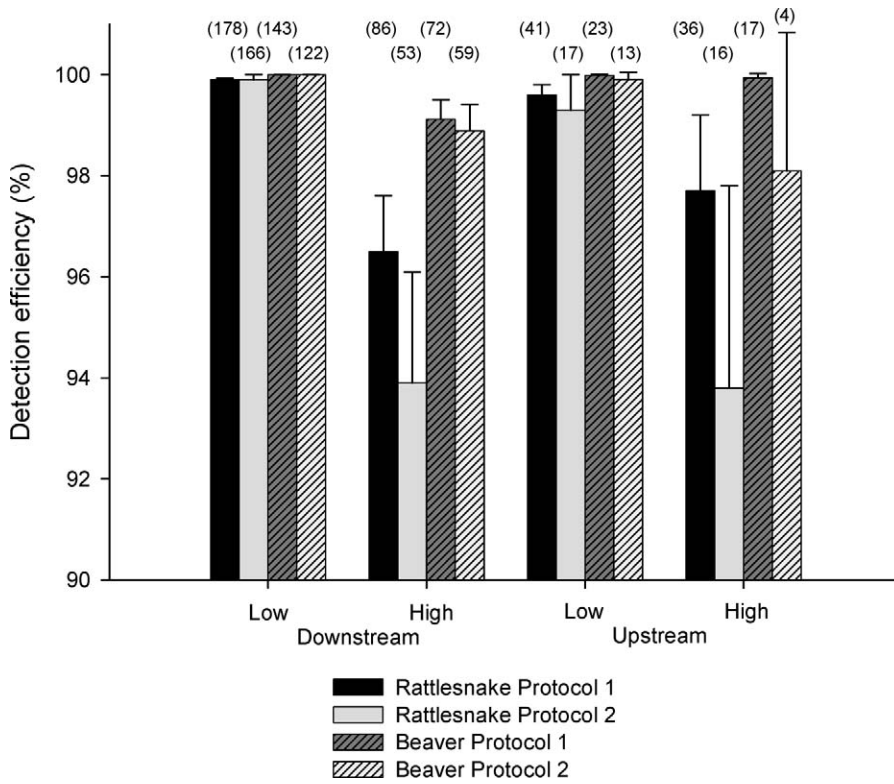

FIGURE 4.—Efficiency of detection of PIT-tagged fish (mean + SE) under two protocols for selecting fish passage events from data recorded by a three-array, six-antenna system at low and high flows in Rattlesnake and Beaver creeks. The number of fish detection events is given in parentheses above each bar. Protocol 1 eliminated a fish passage event if the same fish was detected at any antenna within the previous 12 h or after the first passage event; protocol 2 extended this time interval to 1 month.

minimal difference in detection efficiency was observed (Figure 4). Therefore, we adopted protocol 1, which had the benefit of increasing the available sample size.

Because we did not know the number of PIT-tagged fish that passed the interrogation system, we used an indirect method for determining estimates of detection efficiency. We used a three-array detection probability model (Appendix 1) in the USER program (Lady et al. 2003) to calculate the efficiency of detection of upstream- and downstream-moving fish at low and high flow for the 3×2 systems at Rattlesnake and Beaver creeks. The standard error and variance of this estimate were determined by the Delta method (Seber 1982:7–9; Appendix 2).

Using the accepted fish passage events identified previously, we determined the detection efficiency of systems with lower numbers of antennas: three arrays with one antenna each (3×1), two arrays with two antennas each (2×2), and two arrays with one antenna each (2×1). Because they were the original arrays at the Rattlesnake Creek site, we used the B (middle) and

C (most downstream) arrays for the 2×2 and 2×1 systems (Figure 2). To determine whether to use the river-right or river-left antennas for the 3×1 and 2×1 systems, we calculated the percentage of detections from downstream passage events during low-flow periods that were recorded for each antenna and then used the dominant antenna from each array (Table 2), which proved to be the antennas associated with the thalweg where definitively present. To determine efficiencies of the reduced antenna systems, we used the detection events declared usable by protocol 1, as with the 3×2 systems.

We combined detection data for cutthroat trout (in Rattlesnake Creek only), brook trout (in Beaver Creek only), and rainbow trout including steelhead (in both streams) for our efficiency calculations. Although other species were PIT tagged in each of the watersheds, we either did not detect these other species again (e.g., westslope cutthroat trout in Beaver Creek), or in a few cases, eliminated the detection events from seldom-seen species from our analysis. We did not believe that

TABLE 2.—Percent of detections by river-right (RR) and river-left (RL) antennas in each array of a 3×2 system in Beaver and Rattlesnake creeks at high and low flow levels. Protocol 1 (see Table 1) was used to select passage events; n = the number of fish detection events.

Direction	Array	Flow	Rattlesnake Creek				Beaver Creek			
			n	RR	RL	Both	n	RR	RL	Both
Downstream	A	High	55	60	33	7	51	51	40	8
		Low	154	71	21	8	141	13	70	16
	B	High	68	75	24	1	62	70	25	3
		Low	169	92	6	2	140	47	32	19
	C	High	41	15	83	2	54	22	73	4
		Low	158	4	95	1	137	6	84	7
Upstream	A	High	31	55	39	6	16	44	54	0
		Low	36	31	61	8	22	50	40	8
	B	High	19	37	58	5	13	39	53	6
		Low	35	71	26	3	22	57	25	16
	C	High	17	35	59	6	16	56	20	22
		Low	32	19	75	6	21	22	63	13

it was practical to run a separate analysis without cutthroat trout because of the difficulty in distinguishing hybrid individuals (with rainbow trout). For Beaver Creek, minimal difference ($<0.01\%$) in system efficiency of the 3×2 system was noted when brook trout were removed from consideration (downstream: low flow, $n = 3$, high flow, $n = 0$; upstream: low flow, $n = 2$, high flow, $n = 1$). Combining the more common salmonid species had the advantage of increasing the sample size of fish considered in the analysis.

We used analysis of variance (ANOVA) to test for differences in detection efficiencies attributable to the direction in which fish were moving (downstream or upstream) and flow level (low or high). Stream sites (Rattlesnake and Beaver creeks) were considered replicates and, therefore, never included in interaction terms. When this stream factor did not significantly contribute to the variation of detection efficiencies (ANOVA, $P > 0.05$), it was dropped from the model. To test for differences in detection efficiency among the four designs (3×2 , 3×1 , 2×2 , and 2×1), we used ANOVA, and when the design effect was significant ($P < 0.05$) we used Tukey's Studentized range test (Tukey's test) as a multiple comparison test to identify significant differences among the four designs. Because most values (29 of 32) for detection efficiencies of the systems for various combinations of direction of fish movement and flow level exceeded 80%, we transformed the detection efficiency variable by taking the arcsine of the square root of the estimated detection proportion to stabilize the variances (Ott 1977) before the statistical tests were run. Whenever the normality of the detection efficiency variable was testable (i.e., when $n > 2$), use of the Shapiro-Wilk statistic (SAS Institute 1988) indicated that all groups were normal ($P > 0.05$) after the transformation procedure.

Results

Fish passage events were recorded at a maximum stage height of 1.94 m (flow, $6.31 \text{ m}^3/\text{s}$) in Rattlesnake Creek and 2.03 m ($4.23 \text{ m}^3/\text{s}$) in Beaver Creek (Figure 5). During the overall period in which each system operated, a limited number of days qualified as high flow (Rattlesnake Creek, 21% of 707 d; Beaver Creek, 7% of 596 d). These relatively rare high-flow days, however, accounted for relatively high portions of the downstream and upstream fish passage events (Rattlesnake Creek: 35% downstream and 50% upstream; Beaver Creek: 30% downstream and 39% upstream).

Within the range of stage heights at which fish passage events were recorded, detection efficiency was high for the interrogation systems in Rattlesnake and Beaver creeks. The interrogation system in Rattlesnake Creek had detection efficiencies that ranged from 96% to almost 100% for trout (i.e., rainbow and cutthroat trout) moving downstream or upstream during low or high-flow levels, whereas the system at Beaver Creek had detection efficiencies for salmonids (i.e., rainbow trout, juvenile steelhead, and brook trout) that exceeded 99% for all combinations of direction and flow level (Figure 6). Although relatively minor overall differences in detection efficiency were evident between the two systems, these systems were more efficient during low flow (mean = 99.9%, coefficient of variation [CV = $100 \cdot \text{SE}/\text{mean}$] = 0.2%) than during high flow (mean = 98.3%, CV = 1.5%) (ANOVA: $df = 4, 7$; $P = 0.024$), averaged over the nonsignificant contribution of the direction of fish movement ($P = 0.637$).

The performance of the pass-by and hybrid antenna types varied in a complex way depending on flow level and direction of fish movement (ANOVA, flow \times direction \times type interaction term: $P < 0.001$; Figure 7). The difference in mean efficiency of the hybrid arrays

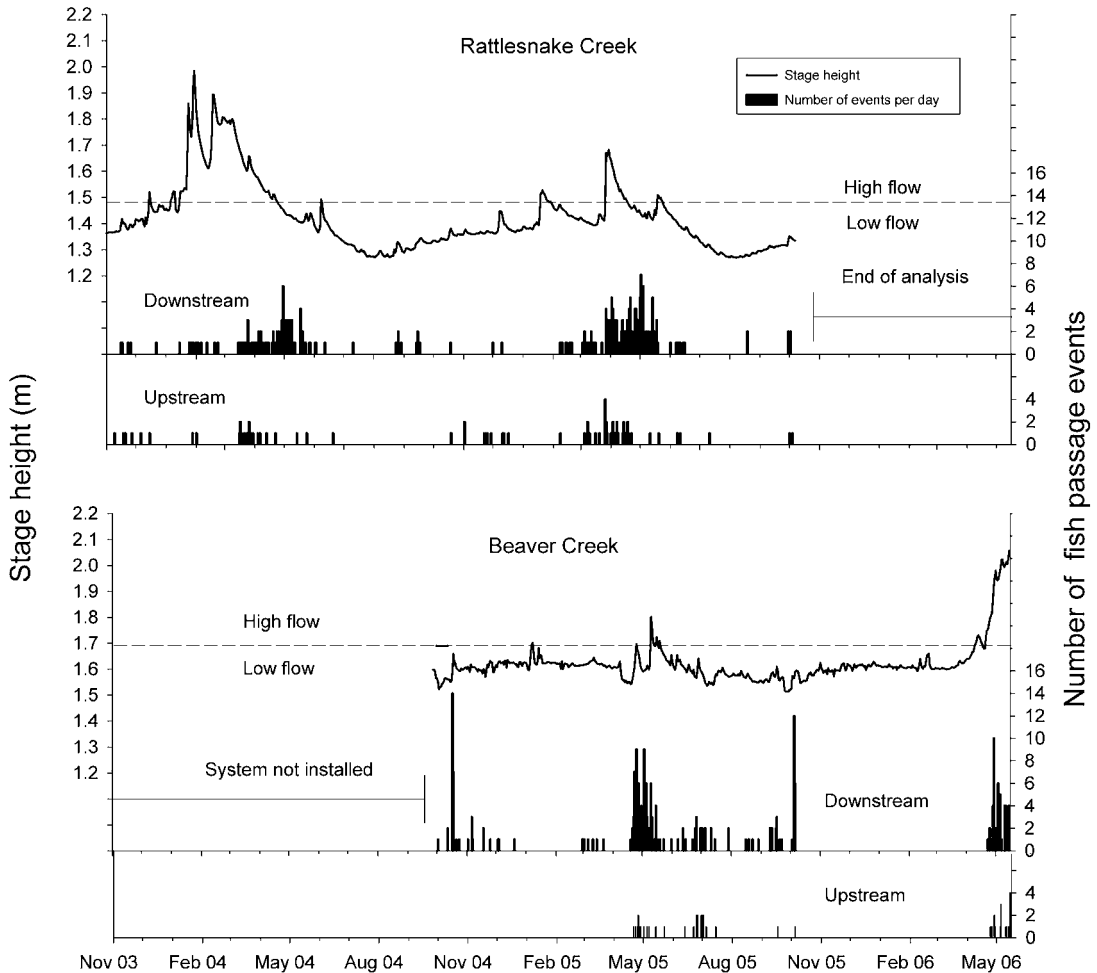

FIGURE 5.—Downstream and upstream fish passage events detected by the PIT tag interrogation system and the stage height in Rattlesnake and Beaver creeks. The distinction between low and high flows is based on the minimum read distance of PIT tags from the top of the lowest instream antenna for each site. The dotted horizontal lines correspond to mean daily stage heights of 1.48 m (flow, 0.38 m³/s) in Rattlesnake Creek and 1.69 m (0.57 m³/s) in Beaver Creek. The maximum values for fish passage events were 1.94 m (6.31 m³/s) and 2.03 m (4.23 m³/s), respectively. The stage–discharge relationship for Rattlesnake Creek is from the authors’ unpublished data and that for Beaver Creek from Ruttenberg (2007).

for downstream-moving fish ($n=4$, mean = 89%, SD = 0.10, CV = 11%) and upstream-moving fish ($n=4$, mean = 77%, SD = 0.19, CV = 24%) was higher and counter gradient to that of the pass-by arrays (downstream: $n=8$, mean = 80%, SD = 0.14, CV = 18%; upstream: $n=8$, mean = 87%, SD = 0.08, CV = 10%). To explore differences in the detection efficiencies of the antenna types, we tested individual combinations of flow level and fish direction. The arrays with hybrid antennas outperformed those with pass-by antennas for detecting fish moving downstream during high flow (ANOVA: $P=0.023$), but the hybrid arrays were less efficient than pass-by arrays for

detecting fish moving upstream during high flow (ANOVA: $P=0.018$). No other combinations of direction and flow level contributed significantly to detection efficiency (ANOVA: $P>0.05$). Some substantial differences in detection efficiency for downstream- and upstream-moving fish were found between our full 3×2 design and the reduced designs (Figure 8). For downstream-moving fish, the 3×2 design had a significantly higher detection efficiency than the 2×1 design (Tukey’s test: $P<0.05$), but no distinction was evident between these and the other designs we tested (Tukey’s test: $P>0.05$). For detection of upstream moving fish, the differences in

efficiency varied with flow level (ANOVA, flow \times design interaction: $P = 0.004$), prompting us to run separate tests by flow level. These tests showed that the 3×2 design had higher detection efficiencies for upstream-moving fish than the 2×1 design and that the 2×2 and 3×1 designs did as well as the 3×2 in high flow, whereas only the 2×2 did as well as the 3×2 design in low flow (ANOVAs and Tukey's tests: $P < 0.05$). For the 2×1 system, the precision of detection efficiency for upstream-moving fish during high flow was much poorer (Rattlesnake Creek, $CV = 55\%$; Beaver Creek, $CV = 79\%$) compared with any other design we tested (all other configurations, $CV < 9\%$). For downstream-moving fish, all four designs had detection efficiencies with good precision ($CV < 8\%$). The observed differences in detection efficiencies for combinations of flow level and direction of fish were complex, but proved to be important to consider if faced with limitations in number of antennas or arrays that can be placed at a given site.

Discussion

The high PIT tag detection efficiencies of 96% to almost 100% that we achieved for PIT-tagged salmonids passing our 3×2 interrogation systems in Rattlesnake and Beaver creeks can largely be attributed to a redundancy of arrays that maintained detection fields over most of, but not all, the stream width and water column. Stream stage height was a factor, our systems doing better in low flow than high flow, but the difference was limited to a few percentage points that may be biologically meaningless to many applications, depending on the number of fish moving through the system and the value of each detection event to the study being conducted.

Stream stage height is probably a major factor in the potential for fish to escape detection. What constitutes high flow will be site dependent. We used tag-detection range to determine the division between low and high flow. The number of fish passage events recorded during high flow was somewhat low, so we did not break flow level into additional categories. However, we did not detect fish when stage height exceeded 1.94 m in Rattlesnake Creek and 2.03 m in Beaver Creek. We do not know whether this was a result of the interrogation system becoming less efficient, whether fish had a decreased tendency to move at high flows, or both. Because the distinction between low and high flow was based on water depth and the read distance of the weakest PIT tag used in the watershed (BE-type in Rattlesnake Creek, ST-type in Beaver Creek), this probably introduced a bias into detectability. Not only did the newer tags offer increased read range, but they also increased the chance that they would be detected at

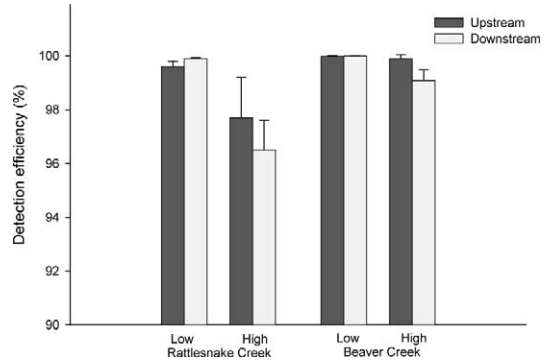

FIGURE 6.—Efficiency of detection of PIT-tagged fish moving upstream or downstream (mean + SE) past PIT tag interrogation systems consisting of three arrays and six antennas in Rattlesnake and Beaver creeks under two flow conditions: low ($\leq 0.14 \text{ m}^3/\text{s}$ in Rattlesnake Creek and $\leq 0.57 \text{ m}^3/\text{s}$ in Beaver Creek) and high ($> 0.14 \text{ m}^3/\text{s}$ and $> 0.57 \text{ m}^3/\text{s}$).

a wider range of orientation to an antenna's interrogation field and to stronger EMF-interfering noise levels. These differences in tag models could have differentially contributed to an underestimate or overestimate of detection efficiency at low- and high-flow levels (Horton et al. 2007). New models of PIT tags are likely to be available in the future and readily adopted by users, especially when older models are phased out of production and become unavailable. Based on the need to eliminate bias of estimates for detection efficiency, researchers and managers may need to anticipate these changes in their study designs.

The arrays with hybrid antennas clearly outperformed those with pass-by antennas for detecting PIT-tagged fish moving downstream during high flow, but the opposite was true for detecting fish moving upstream in high flow. No distinction between antenna types was evident for detection of fish moving during low flow. These findings may be important to researchers faced with a choice among the type of antennas and number of arrays to use because of, for example, lack of funds or limitations imposed by the site. This choice would probably be more effective if based on the configuration that will probably perform best for the fish behavior that it is most desired to track and for the stream characteristics during the period of interest. By using a mix of antenna types, but limiting the use of the more flow-dependent hybrid type to a single array, our systems appeared to have been a good combination for maintaining high detection efficiency during both low and high flow for downstream- and upstream-moving fish.

The hybrid-type antennas actively moved up and down in the water column and did so regularly during

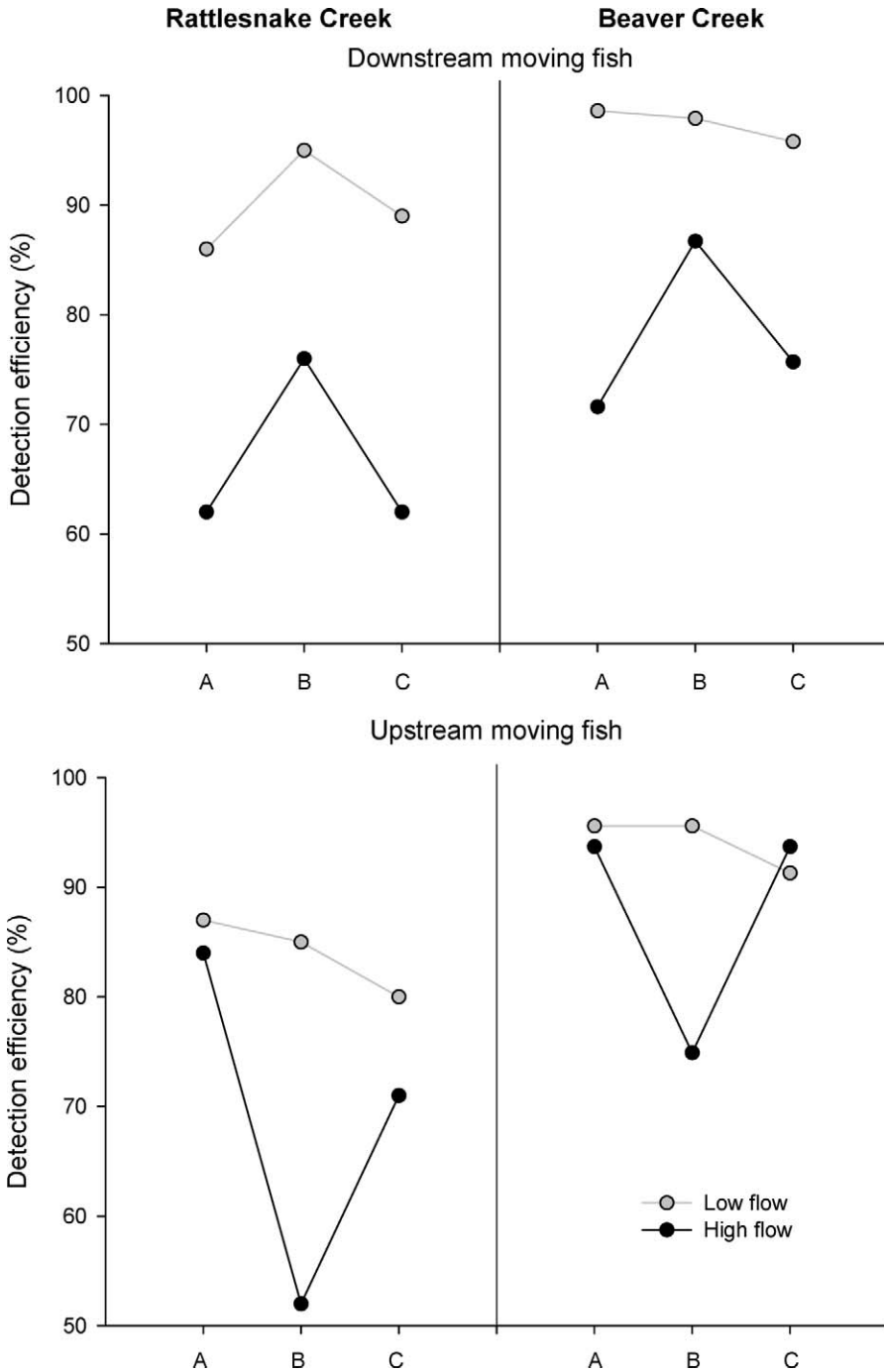

FIGURE 7.—Efficiency of detection of PIT-tagged fish moving upstream and downstream in Rattlesnake and Beaver creeks under high- and low-flow conditions using a three-array, six-antenna configuration. Arrays A and C consisted of two side-by-side pass-by antennas, array B of two side-by-side hybrid antennas.

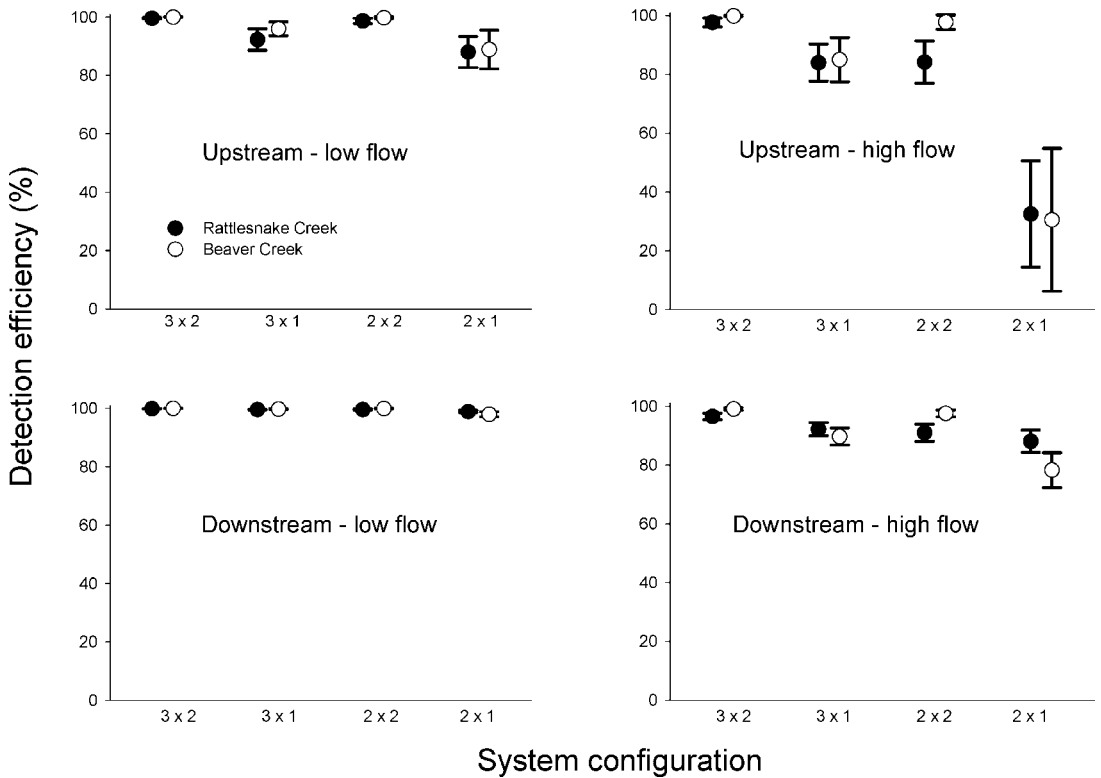

FIGURE 8.—Efficiency of detection (mean \pm SE) of PIT-tagged fish passing four configurations of antennas at two flow levels in Rattlesnake and Beaver creeks. The data for alternative configurations were extracted from data collected by PIT tag interrogation systems that had three arrays with two antennas each.

some flows. Fish moving upstream may have tried to avoid a perceived disturbance caused by the sometimes slow vibrating action of the hybrid antennas. If their response included the choice of a water column depth outside the range of the antenna or an attempt to pass around the antenna, this would account for some of the differences in performance that we observed. Barring differential performance issues based on technology, this suggests that minimizing potential for negative fish response to antennas should be considered as part of the design.

If the entire channel can be spanned, pass-through antennas (the so-called “swim-through” antennas described by Zydlewski et al. 2006) may be appropriate for maximizing detection efficiency. We believe that this orientation, when functioning, provides the best probability of detecting a PIT-tagged fish by any antenna design of which we are aware. This type of antenna is very suitable for stable-flow streams (i.e., those with little or no large debris) for a study limited to investigating fish movement during low-flow periods or if deployed in a manner that allows the antenna to break away under a predetermined load and

be readily repositioned into an operating orientation. The pass-through orientation is particularly suited for taking advantage of existing structures such as bridge crossings, culverts, or engineered study streams. In contrast, our pass-by and hybrid antennas proved to hold during flow and debris conditions that would have disabled most pass-through antennas based on our experience at other locations.

Although we achieved the best results for detection efficiency and precision with our full 3×2 system design, our 2×1 system proved reasonably effective for gaining information on the direction of movement and detection efficiency. However, based on the poor precision (Rattlesnake Creek, CV = 55%; Beaver Creek, CV = 79%) that we gained from the 2×1 systems for detection of upstream-moving fish, one or more additional antennas or an additional array would probably be warranted for deriving a population estimate or conducting a statistical test for response. Much also depends on the stream and site geomorphology. For small stream widths, or for larger streams with good pinch points or a defined thalweg, a well-placed 2×1 system without full stream width or water

column coverage could have a high detection efficiency and good precision for both upstream- and downstream-moving fish, but if one antenna fails, the capability of deciphering directional movement is much diminished.

Because we wanted information on the movement of resident and anadromous fish in relatively remote locations, we developed a stationary, continuously operating PIT tag interrogation system for use in free-flowing streams. Although traps and weirs can be used to obtain similar life history information, these methods are expensive to operate because of staffing needs, and can be difficult to operate year round due to high flow and debris loads. The antennas that we constructed could be placed in a variety of configurations and are highly adaptable to the challenges of stream environments. High gradient or high velocity will make for more difficult and riskier deployments. Our antennas proved to stand up to rigorous conditions of flow and debris loads, but several did become dislodged in Rattlesnake Creek upon extreme conditions of flow in winter 2006 (estimated maximum flow, 41.1 m³/s) after almost continuous detection ability through the previous two winters. The Beaver Creek system ran from September 2004 until unusually high flows in spring of 2006 (>8.86 m³/s) disabled most of the antennas. Because of redundancy in arrays and redundancy of antennas within arrays, the retention of some or most antennas allowed some level of continuous monitoring of fish movement, though ability to determine detection efficiency and direction of fish movement was not possible when at least one upstream and one downstream antenna was not maintained.

Since beginning our project in Rattlesnake Creek in 2001, we have improved the anchoring systems. We replaced nylon cord tied to anchors with heavy webbing with metal cam buckles. To secure the systems we are currently operating and deploying, we increased the number of anchor points. Despite upgrades in gear and amount of anchoring, we thought it futile and too expensive to attempt to build a system that could withstand all flows, especially flows that initiate movement of the bed load that the system may be anchored to. An interrogation system that is too formidable may actually be harmful to a stream if it causes debris jams and subsequent redirection of stream flow.

Study goals, target species, and budget will dictate the specific designs of interrogation systems. We wanted an interrogation system that would differentiate between upstream and downstream movement, and we wanted to be able to estimate detection efficiency and the precision of the estimate without the use of known

numbers of passing fish. We developed a protocol that determined whether to include or exclude a fish that was detected on a single antenna. While incorrect assignment was possible, we believe that the adopted protocol minimized it. It was also possible that the calculations of detection efficiency underestimated the number of tagged fish passing the antennas that did not get detected on any of the antennas, especially during high flows. Use of a known tagged fish population passing the interrogation site to assess our derived efficiency estimates was not feasible, because of cost and permitting restrictions. Where possible, the use of a known population of PIT-tagged fish, such as salmonid smolts with strong one-way migratory tendencies, would likely prove helpful. If direction of movement is known and efficiency of detection can be empirically determined, it becomes much simpler and more direct to derive estimates of total fish passing the detector site and to assign weights to particular life history strategies.

Our efficiency calculations were derived with passage information from trout (primarily rainbow trout and steelhead but also cutthroat and brook trout). The fish in Rattlesnake Creek were resident juvenile and adult trout from Rattlesnake and Indian creeks and the White Salmon River. Historically, the White Salmon subbasin supported anadromous salmonids, but was blocked by Condit Dam at rkm 5.0 in 1913. In Beaver Creek, there was a mixture of resident and anadromous juvenile and adult rainbow trout and steelhead and a few resident brook trout. We combined some salmonid species in our analysis, but this may not be justified in other studies. Smolt trap studies have shown differences in capture efficiencies for various salmonids (Thedinga et al. 1994) and between hatchery and wild fish (Roper and Scarnecchia 1996). Some of the differences in capture efficiencies may be the result of trap avoidance, but may also be related to position in the water column. This may be particularly important in large streams where fish may have deeper water columns available to them.

At the time of this study, the electrical functionality of the transceivers and the electrical properties of the cables connecting the antennas to the transceivers limited the size of the antennas that we could use to about 3 m long × 1.25 m wide. This size limitation is changing with new technology. The antenna size limitation was addressed in our study design by adding a second antenna within an array, thus allowing for more complete spanning of the channel width. We found that a three-array system allowed a good measure of redundancy in case of mishaps. Some of the problems that we or others have encountered include power disruption (e.g., AC outages, battery

problems), excessive heat shutting down transceivers, theft, wildlife chewing into cables, floating logs dislodging antennas, and moving substrate damaging cables and antennas. In addition, the probability of a tagged fish's blocking the reading of other fish passing by or through the system is reduced when multiple small antennas are used. The use of smaller antennas can reduce the problems associated with attaching them to an uneven stream bottom. Combinations of these kinds of problems have convinced us that there is a high potential for mishaps when attempting to keep these systems operating for extended periods of time, and that measures for redundancy are warranted based on the value of the data.

Acknowledgments

Development, installation, and maintenance of the interrogation systems relied on several National Oceanic and Atmospheric Administration personnel, including Sandra Downing, Bruce Jonasson, Ed Nunnallee (retired), and the National Marine Fisheries Service Pasco Field Station shop crew, especially Jim Simonson and William Wassard. The PIT-tagging field work and day-to-day maintenance of the detector system was conducted by U.S. Geology Survey (USGS) personnel, including Brian Fisher, Wes Tibbits, Ben Lenz, Brady Allen, Jodi Charrier, Gene Hoilman, Carrie Munz, Sarah Rose, Chris Schaeffer, and Joel Quenette. We thank Russell Perry of the USGS for helping us develop the estimates of variance for detection efficiency. The two interrogator sites were located on private land, and we much appreciate the access granted by landowners Steve Stampfli, Terry Tietjen, and Vic Stokes. We also thank Pacific States Marine Fisheries Commission's field crew, including Allen Brower, Darren Chase, Scott Livingston, and Don Warf, as well as the PTAGIS database crew including Dave Marvin, Carter Stein, and John Tenney. Dan Rawding of Washington Department of Fish and Wildlife and Eric Janney of USGS provided helpful reviews of an earlier version of the manuscript. William Connor of U.S. Fish and Wildlife Service and two anonymous reviewers provided valuable comments and suggestions. The Rattlesnake Creek work was supported from a larger effort funded by Bonneville Power Administration, and the Beaver Creek work was supported from a larger effort funded by the U.S. Bureau of Reclamation. Any use of trade names is for descriptive purposes only and does not imply endorsement of the U.S. government.

References

- Achord, S., G. M. Matthews, O. W. Johnson, and D. M. Marsh. 1996. Use of passive integrated transponder (PIT)

tags to monitor migration timing of Snake River Chinook salmon smolts. *North American Journal of Fisheries Management* 16:302–313.

Armstrong, J. D., V. A. Braithwaite, and P. Rycroft. 1996. A flat-bed passive integrated transponder antenna array for monitoring behavior of Atlantic salmon parr and other fish. *Journal of Fish Biology* 48:539–541.

Armstrong, J. D., F. A. Huntingford, and N. A. Herbert. 1999. Individual space use strategies of wild Atlantic salmon. *Journal of Fish Biology* 55:1201–1212.

Axel, G. A., E. F. Prentice, and B. P. Sandford. 2005. PIT tag detection system for large-diameter juvenile fish bypass pipes at Columbia River basin hydroelectric dams. *North American Journal of Fisheries Management* 25:646–651.

Burke, B. J., and M. A. Jepson. 2006. Performance of passive integrated transponder tags and radio tags in determining passage behavior of adult Chinook salmon and steelhead. *North American Journal of Fisheries Management* 26:742–752.

Castro-Santos, T., A. Haro, and S. Walk. 1996. A passive integrated transponder (PIT) tag system for monitoring fishways. *Fisheries Research* 28:253–261.

Columbia Basin Fish and Wildlife Authority. 1999. PIT tag marking procedures manual. Columbia Basin Fish and Wildlife Authority, Portland, Oregon.

Connolly, P. J., I. G. Jezorek, and E. F. Prentice. 2005. Development and use of in-stream PIT tag detection systems to assess movement behavior of fish in tributaries of the Columbia River basin, USA. Pages 217–220 in L. P. J. J. Noldus, F. Grieco, L. W. S. Loijens, and P. H. Zimmerman, editors. *Proceedings of the 5th international conference on methods and techniques in behavioral research*. Noldus Information Technology, Wageningen, The Netherlands.

Downing, S. L., D. Chase, and A. Brower. 2005. More information regarding new tag on the block. *Pacific States Marine Fisheries Commission, PTAGIS Newsletter* 6(5):7–13.

Greenberg, L. A., and P. S. Giller. 2000. The potential of flat-bed passive integrated transponder antennae for studying habitat use by stream fishes. *Ecology of Freshwater Fish* 9:74–80.

Horton, G. E., T. L. Dubreuil, and B. Letcher. 2007. A model for estimating passive integrated transponder (PIT) tag antenna efficiencies for interval-specific emigration rates. *Transactions of the American Fisheries Society* 136:1165–1176.

Juanes, F., B. H. Letcher, and G. Gries. 2000. Ecology of stream fish: insights gained from an individual-based approach to juvenile Atlantic salmon. *Ecology of Freshwater Fish* 9:65–73.

Lady, J. M., P. Westhagen, and J. R. Skalski. 2003. USER 2.1 user-specified estimation routine. Report to the Bonneville Power Administration, Project 8910700, Portland, Oregon.

Muir, M. D., S. G. Smith, J. G. Williams, and E. E. Hockersmith. 2001a. Survival estimates for migrant yearling spring Chinook salmon and steelhead tagged with passive integrated transponders in the lower Snake and lower Columbia rivers, 1993–1998. *North American Journal of Fisheries Management* 21:269–282.

Muir, M. D., S. G. Smith, J. G. Williams, and B. P. Sandford.

- 2001b. Survival of juvenile salmonids passing through bypass systems, turbines, and spillways with and without flow deflectors at Snake River dams. *North American Journal of Fisheries Management* 21:135–146.
- Nunnallee, E. P., E. F. Prentice, B. F. Jonasson, and W. Patten. 1998. Evaluation of a flat-plate PIT tag interrogation system at Bonneville Dam. *Aquacultural Engineering* 17:261–272.
- Ott, L. 1977. An introduction to statistical methods and data analysis. Duxbury Press, North Scituate, Massachusetts.
- Peterson Engineering Services. 2002. Super tag and standard tag comparison test. Report to Pacific States Marine Fisheries Commission, Portland, Oregon.
- Peterson, N. P., E. F. Prentice, and T. P. Quinn. 1994. Comparison of sequential coded wire and passive integrated transponder tags for assessing overwinter growth and survival of juvenile coho salmon. *North American Journal of Fisheries Management* 14:870–873.
- Prentice, E. F., T. A. Flagg, and C. S. McCutcheon. 1990. Feasibility of using implantable passive integrated transponder (PIT) tags in salmonids. Pages 317–322 in N. C. Parker, A. E. Giorgi, R. C. Heidinger, D. B. Jester, Jr., E. D. Prince, and G. A. Winans, editors. *Fish-marking techniques*. American Fisheries Society, Symposium 7, Bethesda, Maryland.
- Prentice, E. F., D. L. Park, T. A. Flagg, and C. S. McCutcheon. 1986. A study to determine the biological feasibility of a new fish tagging system, 1985–1986. Report to Bonneville Power Administration, Project 83-19, Portland, Oregon.
- Riley, W. D., M. O. Eagle, and S. J. Ives. 2002. The onset of downstream movement of juvenile Atlantic salmon, *Salmo salar* L., in a chalk stream. *Fisheries Management and Ecology* 9:87–89.
- Riley, W. D., M. O. Eagle, M. J. Ives, P. Rycroft, and A. Wilkinson. 2003. A portable passive integrated transponder multipoint decoder system for monitoring habitat use and behaviour of freshwater fish in small streams. *Fisheries Management and Ecology* 10:265–268.
- Roper, B., and D. L. Scarnecchia. 1996. A comparison of trap efficiencies for wild and hatchery age-0 Chinook salmon. *North American Journal of Fisheries Management* 16:214–217.
- Roussel, J.-M., R. A. Cunjak, R. Newbury, D. Caissie, and A. Haro. 2004. Movements and habitat use by PIT-tagged Atlantic salmon parr in early winter: the influence of anchor ice. *Freshwater Biology* 49:1026–1035.
- Ruttenberg, D. 2007. An evaluation of fish passage at rock vortex weirs. Master's thesis. University of Idaho, Moscow.
- SAS Institute. 1988. SAS procedures guide, release 6.03 edition. SAS Institute, Cary, North Carolina.
- Seber, G. A. F. 1982. The estimation of animal abundance and related parameters. Macmillan, New York.
- Skalski, J. R., S. G. Smith, R. N. Iwamoto, J. G. Williams, and A. Hoffman. 1998. Use of passive integrated transponder tags to estimate survival of migrant juvenile salmonids in the Snake and Columbia rivers. *Canadian Journal of Fisheries and Aquatic Sciences* 55:1484–1493.
- Thedinga, J. F., M. L. Murphy, S. W. Johnson, J. M. Lorenz, and K. V. Koski. 1994. Determination of salmonid smolt yield with rotary-screw traps in the Situk River, Alaska, to predict effects of glacial flooding. *North American Journal of Fisheries Management* 14:837–851.
- USFS (U.S. Forest Service). 2004. Beaver Creek stream survey report 2004. Okanogan–Wenatchee National Forest, Methow Ranger District, Winthrop, Washington.
- Zabel, R. W., and S. Achord. 2004. Relating size of juveniles to survival within and among populations of Chinook salmon. *Ecology* 85:795–806.
- Zydlewski, G. B., A. Haro, K. G. Whalen, and S. D. McCormick. 2001. Performance of stationary and portable passive transponder detection systems for monitoring of fish movements. *Journal of Fish Biology* 58:1471–1475.
- Zydlewski, G. B., G. Horton, T. Dubreuil, B. Letcher, S. Casey, and J. Zydlewski. 2006. Remote monitoring of fish in small streams: a unified approach using PIT tags. *Fisheries* 31:492–502.

Appendix 1: Calculation of Detection Efficiencies

The formulae below show how we calculated detection efficiencies (which we equate to probabilities of detection) for our 3×2 PIT tag interrogation system. The 3×2 system consisted of a serial arrangement of three arrays of two antennas each, which we labeled (from upstream to downstream) as arrays A, B, and C. A PIT-tagged fish that passed the system and was detected could have one of seven array detection histories. The fish with the different array detection histories were summed (S) as follows:

- Sa = fish detected only on array A
 Sab = fish detected on both array A and array B but not array C
 Sac = fish detected on both array A and array C but not array B

- Sabc = fish detected on array A, array B, and array C
 Sb = fish detected only on array B
 Sc = fish detected only on array C
 Sbc = fish detected on both array B and array C but not array A

To calculate the detection efficiency of array A, four values were required. These were generated from the numbers of fish within each array detection history as follows:

- NA = fish detected on array A (Sa + Sab + Sac + Sabc),
 NABC = fish detected on array A and at least one other array (Sab + Sac + Sabc),

NBC = fish detected on arrays other than array A = (Sb + Sc + Sbc)
 UA = fish undetected by array A, estimated as (NA × NBC) / NABC

The detection efficiency of array A (PA) was then derived from the equation

$$PA = NA / (NA + UA).$$

The detection efficiencies for arrays B and C were calculated in the same fashion. The detection efficiency for the entire system (P) was then calculated as

$$P = 1 - [(1 - PA) \times (1 - PB) \times (1 - PC)].$$

Appendix 2: Estimation of the Variance of the Detection Efficiency

To calculate the detection efficiency, variance (V), and standard error (SE) for the entire interrogation system, we used a likelihood model available in the Lady et al.'s (2003) USER program; the variance and SE were estimated using the delta method (Seber 1982:7-9).

Following the delta method, the variance is calculated as

$$V[g(x)] \approx \sum_{i=1}^n \text{var}[x_i] \left(\frac{\partial g}{\partial x_i} \right)^2 + 2 \sum_{i < j} \text{cov}[x_i, x_j] \left(\frac{\partial g}{\partial x_i} \right) \left(\frac{\partial g}{\partial x_j} \right).$$

The standard error (SE_{p̂}) is calculated as

$$\begin{aligned} SE_{\hat{p}} = & \{ SE_{\hat{p}_A}^2 [(\hat{p}_B - 1)(\hat{p}_C - 1)]^2 \\ & + SE_{\hat{p}_B}^2 [(\hat{p}_A - 1) \times (\hat{p}_C - 1)]^2 \\ & + SE_{\hat{p}_C}^2 [(\hat{p}_A - 1)(\hat{p}_B - 1)]^2 \\ & + 2 \{ [\text{cov}\hat{p}_A, \hat{p}_B(\hat{p}_B - 1)(\hat{p}_C - 1)(\hat{p}_A - 1) \\ & \quad \times (\hat{p}_C - 1)] \\ & + [\text{cov}\hat{p}_A, \hat{p}_C(\hat{p}_B - 1)(\hat{p}_C - 1)(\hat{p}_A - 1) \\ & \quad \times (\hat{p}_B - 1)] \\ & + [\text{cov}\hat{p}_B, \hat{p}_C(\hat{p}_A - 1)(\hat{p}_C - 1)(\hat{p}_A - 1) \\ & \quad \times (\hat{p}_B - 1)] \}^{1/2}; \end{aligned}$$

- \hat{p}_A = the estimated detection efficiency of array A,
- \hat{p}_B = the estimated detection efficiency of array B,
- \hat{p}_C = the estimated detection efficiency of array C,
- SE_{p̂A} = the standard error of the detection efficiency of array A,
- SE_{p̂B} = the standard error of the detection efficiency of array B, and
- SE_{p̂C} = the standard error of the detection efficiency of array C.