

NASA / CR-2000-210634

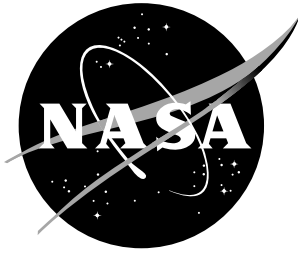

Flow Duct Data for Validation of Acoustic Liner Codes for Impedance Education

*K. K. Ahuja, Scott Munro, and R. J. Gaeta, Jr.
Georgia Institute of Technology, Atlanta, Georgia*

December 2000

The NASA STI Program Office ... in Profile

Since its founding, NASA has been dedicated to the advancement of aeronautics and space science. The NASA Scientific and Technical Information (STI) Program Office plays a key part in helping NASA maintain this important role.

The NASA STI Program Office is operated by Langley Research Center, the lead center for NASA's scientific and technical information. The NASA STI Program Office provides access to the NASA STI Database, the largest collection of aeronautical and space science STI in the world. The Program Office is also NASA's institutional mechanism for disseminating the results of its research and development activities. These results are published by NASA in the NASA STI Report Series, which includes the following report types:

- **TECHNICAL PUBLICATION.** Reports of completed research or a major significant phase of research that present the results of NASA programs and include extensive data or theoretical analysis. Includes compilations of significant scientific and technical data and information deemed to be of continuing reference value. NASA counterpart of peer-reviewed formal professional papers, but having less stringent limitations on manuscript length and extent of graphic presentations.
- **TECHNICAL MEMORANDUM.** Scientific and technical findings that are preliminary or of specialized interest, e.g., quick release reports, working papers, and bibliographies that contain minimal annotation. Does not contain extensive analysis.
- **CONTRACTOR REPORT.** Scientific and technical findings by NASA-sponsored contractors and grantees.
- **CONFERENCE PUBLICATION.** Collected papers from scientific and technical conferences, symposia, seminars, or other meetings sponsored or co-sponsored by NASA.
- **SPECIAL PUBLICATION.** Scientific, technical, or historical information from NASA programs, projects, and missions, often concerned with subjects having substantial public interest.
- **TECHNICAL TRANSLATION.** English-language translations of foreign scientific and technical material pertinent to NASA's mission.

Specialized services that complement the STI Program Office's diverse offerings include creating custom thesauri, building customized databases, organizing and publishing research results ... even providing videos.

For more information about the NASA STI Program Office, see the following:

- Access the NASA STI Program Home Page at <http://www.sti.nasa.gov>
- E-mail your question via the Internet to help@sti.nasa.gov
- Fax your question to the NASA STI Help Desk at (301) 621-0134
- Phone the NASA STI Help Desk at (301) 621-0390
- Write to:
NASA STI Help Desk
NASA Center for Aerospace Information
7121 Standard Drive
Hanover, MD 21076-1320

NASA / CR-2000-210634

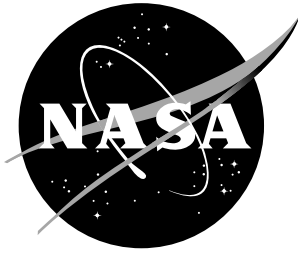

Flow Duct Data for Validation of Acoustic Liner Codes for Impedance Education

*K. K. Ahuja, Scott Munro, and R. J. Gaeta, Jr.
Georgia Institute of Technology, Atlanta, Georgia*

National Aeronautics and
Space Administration

Langley Research Center
Hampton, Virginia 23681-2199

Prepared for Langley Research Center
under Grant NAG1-1734

December 2000

Available from:

NASA Center for AeroSpace Information (CASI)
7121 Standard Drive
Hanover, MD 21076-1320
(301) 621-0390

National Technical Information Service (NTIS)
5285 Port Royal Road
Springfield, VA 22161-2171
(703) 605-6000

Foreword/Acknowledgments

This report was prepared by the Acoustics and Aerospace Technologies Branch of the Aerospace, Transportation, and Advanced Systems Laboratory (ATASL) of Georgia Tech Research Institute (GTRI) for NASA Langley Research Center, Hampton, Virginia, under Grant NAG1-1734.

Mr. Mike Jones was the Project Manager for NASA Langley Research Center. GTRI's Project Director was Dr. K.K. Ahuja. Much of the data presented here was acquired by Mr. Scott Munro, a Doctoral student working under the direction of Dr. Ahuja.

Special thanks are due to Dr. W. Watson of NASA Langley Research Center who provided sanitation checks for the data as it was being acquired by comparing our data with his impedance education code.

The authors would also like to acknowledge the assistance of Mr. Jeff Hsu of GTRI who developed the automated data acquisition capability of the facility and a number of students who assisted us operate the flow facility during the data acquisition.

Note that this report is one of five separate volumes prepared to document the work conducted by GTRI under NASA Grant NAG1-1734. The GTRI report numbers, authors, and titles of each report are listed in the table below:

<u>GTRI Report Number</u>	<u>Authors</u>	<u>Title</u>
A5004/2000-1	Ahuja, K. K. and Gaeta, R. J.	Active Control of Liner Impedance by Varying Perforate Orifice Geometry
A5004/2000-2	Ahuja, K. K. Munro, S. E., and Gaeta, R. J.	Flow Duct Data for Validation of Acoustic Liner Codes for Impedance Education
A5004/2000-3	Ahuja, K. K., Gaeta, R. J, and D'Agostin, M. S.	High Amplitude Acoustic Behavior of a Slit-Orifice backed by a Cavity
A5004/2000-4	Ahuja, K. K., Gaeta, R. J, and D'Agostin, M. S.	Acoustic Absorption Characteristics of an Orifice With a Mean Bias Flow
A5004/2000-5	Ahuja, K. K., Cataldi, P., and Gaeta, R. J.	Sound Absorption of a 2DOF Resonant Liner with Negative Bias Flow

Table of Contents

Description	Page
Forward/Acknowledgments	i
Table of Contents	ii
List of Figures	iv
List of Tables	vii
Executive Summary	viii
1.0 Introduction	1
2.0 Test Facility and Instrumentation	1
2.1 Introduction	1
2.2 Flow Facility	1
2.2.1 Instrumentation Sections	1
2.2.2 Liner Housing Section	2
2.2.3 Exhaust Section	3
2.3 Instrumentation for Data Acquisition and Analysis	3
2.3.1 Axial Centerline Acoustic Measurement Probe	3
2.3.2 Instrumentation for Flow Data	4
2.3.3 Acoustic Data Acquisition System	5
2.4 Test Liner	6
2.5 Impedance Tube	6
3.0 Technical Approach	7
3.1 Summary of Technical Approach	7
3.2 Experimental Set-up	8
3.3 Mean Flow Measurements	8
3.4 Calibration of Microphone Probes	9
3.4.1 Method of Calibration	9
3.4.2 Eduction Technique for Rejecting Flow Noise	10
3.4.3 Methodology for Rejecting Flow Noise from In-flow Acoustic Measurements	10

4.0	Measured Data for Code Validation.....	12
4.1	Summary of Measured Data.....	12
4.2	Typical Flow Duct Measurements.....	12
4.2.1	Measurement Locations.....	13
4.2.2	Typical Hard Wall Measurements.....	14
4.2.3	Discussion of Suspect Data.....	14
5.0	References.....	16
6.0	Appendix.....	64

List of Figures

Figure	Page
Figure 1a. Photo of flow duct facility.....	17
Figure 1b. Schematic of flow duct facility.....	18
Figure 1c. Schematic of liner section of flow duct facility.....	19
Figure 2. Schematic of microphone and pressure probe traverse system.....	20
Figure 3. Cross-sectional schematic of instrumentation box.....	21
Figure 4. Inside view of instrumentation traverse box.....	22
Figure 5. Liner housing schematic.....	23
Figure 6. Axial acoustic measurement probe.....	24
Figure 7. Pressure probe used for plane measurements.....	25
Figure 8. Schematic of mean flow data acquisition.....	25
Figure 9. Acoustic data acquisition schematic.....	26
Figure 10. Microphone probe used in plane acoustic measurements.....	27
Figure 11. Photo of flush mounted microphone.....	28
Figure 12. Impedance tube set-up used for normal impedance tests.....	29
Figure 13. Absorption coefficient calculated from impedance tube tests.....	30
Figure 14. Resistance and reactance calculated from impedance tube tests.....	31
Figure 15a. Photo of liner used in experiments.....	32
Figure 15b. Photos of flow duct with liner installed on side walls.....	33
Figure 16. Velocity profiles for hard wall and lined wall cases for Mach number = 0.1....	34
Figure 17. Velocity profiles for hard wall and lined wall cases for Mach number = 0.2....	35

Figure 18.	Velocity profiles for hard wall and lined wall cases for Mach number = 0.3.	36
Figure 19.	Velocity profiles across the major axis for various Mach numbers without liners installed.	37
Figure 20.	Velocity profiles across the major axis for various Mach numbers with liner installed.	38
Figure 21.	Calibration correction for probe p5, typical calibration result.	39
Figure 22.	Phase calibration correction for probe p5, typical calibration result.	40
Figure 23.	Sample plot demonstrating SPL correction procedure.	41
Figure 24.	Schematic of signal processing path.	42
Figure 25.	Measurement locations schematic.	43
Figure 26.	SPL data for 500 Hz hard wall case.	44
Figure 27.	Phase data for 500 Hz hard wall case.	45
Figure 28.	SPL data for 1000 Hz hard wall case.	46
Figure 29.	Phase data for 1000 Hz hard wall case.	47
Figure 30.	SPL data for 1500 Hz hard wall case.	48
Figure 31.	Phase data for 1500 Hz hard wall case.	49
Figure 32.	SPL data for 2000 Hz hard wall case.	50
Figure 33.	Phase data for 2000 Hz hard wall case.	51
Figure 34.	SPL data for 2500 Hz hard wall case.	52

List of Figures - Continued

Figure	Page
Figure 35. Phase data for 2500 Hz hard wall case.....	53
Figure 36. SPL data for 500 Hz lined wall case.....	54
Figure 37. Phase data for 500 Hz lined wall case.....	55
Figure 38. SPL data for 1000 Hz lined wall case.....	56
Figure 39. SPL data for 1000 Hz lined wall case.....	57
Figure 40. SPL data for 1500 Hz lined wall case.....	58
Figure 41. Phase data for 1500 Hz lined wall case.....	59
Figure 42. SPL data for 2000 Hz lined wall case.....	60
Figure 43. Phase data for 2000 Hz lined wall case.....	61
Figure 44. SPL data for 2500 Hz lined wall case.....	62
Figure 45. Phase data for 2500 Hz lined wall case.....	63

List of Tables **Page**

Table 1. Summary of Data Acquired 12

Executive Summary

The objective of the study reported here was to acquire acoustic and flow data with hard and lined duct wall sections for validation of a liner prediction code being developed at NASA LaRC. Both the mean flowfield and acoustic flowfields were determined in a cross-plane of the rectangular duct. A flow duct facility with acoustic drivers connected to a rectangular (4.7 x 2.0 inch) source section and a linear acoustic liner mounted downstream of the source section was used in this study. The liner section was designed to allow liner materials to be placed on all 4 walls of the duct. The test liner was of the locally-reacting type and was made from a ceramic material. The material, consisting of a tubular structure, was provided by NASA LaRC. The liner was approximately 8.89 cm (3.5 inches) thick. For the current study, only the two “short” sides of the duct were lined with liner material. The other two sides were hard walls. Two especially built instrumentation sections were attached on either side of the liner section to allow acoustic and flow measurements to be made upstream and downstream of the liner. The two instrumentation duct sections were built to allow measurement of acoustic and flow properties at planes perpendicular to flow, upstream and downstream of the liner section. The instrumentation section was also designed to provide a streamwise gradient in acoustic (complex) pressure from which the acoustic particle velocity, needed for the model validation, can be computed.

Flow measurements included pressure, temperature, and velocity profiles upstream of the liner section. The in-flow sound pressure levels and phases were obtained with a microphone probe equipped with a nose cone in two cross planes upstream of the liner and in two cross plane downstream of the liner. In addition to the acoustic measurements at the cross planes, axial centerline acoustic data was acquired using an axially traversing microphone probe, which was traversed from a location upstream of the liner to some distance downstream of the liner. All probes used here had to be calibrated with respect to a standard microphone equipped with a nose cone to allow for the effects of flow.

Since acquisition of acoustic data in the presence of flow was desired, a method of extracting the acoustic signal based upon cross-correlation methods was implemented to reject flow noise from the data.

Much of the data was acquired for frequencies of 500, 1000, 1500, 2000, and 2500 Hz for duct mean flow Mach numbers of 0.0, 0.1, 0.2, and 0.3 tested.

This data was acquired for the validation of the prediction code being developed by Dr. William Watson at NASA LaRC. Since this task was primarily for acquisition of data for the validation of the code, most of the interpretation of the results has been left up to NASA LaRC. These data have been archived here for the use of other researcher developing similar and more advanced liner impedance prediction codes.

1.0 Introduction

The objective of this task was to acquire acoustic and flow data with hard and lined wall duct sections for validation of a liner prediction code being developed at NASA LaRC by Dr. W. Watson..

2.0 Test Facility and Instrumentation

2.1 Introduction

Much of this task was a follow-on effort to work completed and documented in NASA CR-201667 (Ref. 1). Details of the flow duct system and instrumentation system can be found in this reference. A short description of the facility and instrumentation is provided below.

2.2 Flow Facility

All the work described here was performed in the GTRI Liner Flow Duct Facility. The facility can be operated with single or coaxial flow at plenum temperatures ranging from ambient to $\sim 1200^\circ$ F. A photo and a schematic of the flow facility as configured for the present study are shown in Figure 1a-c. Figure 1a shows a photo of the facility, Figure 1b is a general schematic of the facility, and Figure 1c is a schematic of the region near the liner section showing dimensions pertinent to the study. The primary plenum diameter is 26.5 cm (10.1 inch) and contracts to a 10.2 cm (4.0 inch) diameter exit. An outer coannular plenum, not used in the present work, provides the source of coaxial flow when desired. Both plenums have flange connections to accept various nozzle or duct components depending on the experiment. For the present study, a round-to-rectangular transition section was mounted immediately downstream of the plenum exit. A rectangular (4.7 x 2.0 inch) source section was connected to the transition section. This rectangular source section is different from the facility described in Ref. 1, where an axisymmetric source section was used. Four acoustic drivers were attached to the duct section via tubes centered on each of the 4 duct sides. Two straight duct sections, each 4 inches in length, were installed downstream of the source section to allow for any anomalies generated at the source section to dissipate. Downstream of the straight sections, the first instrumentation section was installed, followed by the liner section. The second instrumentation section was installed downstream of the liner section. The last piece of the duct facility is the exit nozzle section. This set-up allowed for acoustic and flow measurements to be made upstream and downstream of the liner. This was the only set-up needed for the task because only downstream propagation data was of interest.

The two instrumentation sections are the same as were used in Reference 1, however a brief description will be provided below. The liner section is also similar to the liner section manufactured for Reference 1, however the design was changed to allow for all four walls to be lined rather than just two.

2.2.1 Instrumentation Sections

Two instrumentation duct sections were built to allow measurement of acoustic and flow properties at planes perpendicular to flow, upstream and downstream of the liner section. Figure 2 shows a schematic of one of the instrumentation boxes. The Figure focuses on just

the probe-insertion location and the probe's translational degrees of freedom. Note that the vertical travel of the probe in the duct is accomplished by a "slide rule" type traverse sled. This concept allows for vertical travel while still maintaining a flush inner-duct flow path. Horizontal travel is achieved by the probe translating in and out through a circular slot in a traverse sled. The horizontal and vertical motions are actuated via stepper motors for accuracy. Two such instrumentation sections were built to provide planar in-duct measurements upstream and downstream of the liner housing section.

Air is allowed to leak out of the duct through the probe entry opening as well as around the vertical sled groove into an air-tight containment. It was felt that if this section outside the duct could be isolated inside an air-tight enclosure, the pressure inside the enclosure would equalize with that inside of the duct. Figure 3 shows a cross sectional view of the instrumentation section showing the outer containment box concept. It shows how the translating sensing probe is enclosed, providing an air-tight method of intrusive duct-flow and acoustic measurements. Note that the stepper motors are located outside of the outer enclosure. Placement of the motors outside of the enclosure will protect them from the potentially hot environment produced by heated duct flows in future studies. Data from the probes is transmitted out through the enclosure via sealed electrical interfaces and pressure connections. Figure 4 shows an inside view of the instrumentation box. The traverse system can accept a 0.64-cm (0.25-in) diameter probe. All parts are fabricated from stainless steel to facilitate heated duct flows.

An additional feature of the 2-D probe traverse system is an axial offset mechanism. This was designed to provide measurements in two planes which are offset axially (in the x-direction) by 0.76 cm (0.3 in). This requirement was introduced in the design in order to provide a streamwise gradient in acoustic (complex) pressure from which the acoustic particle velocity can be computed. The 0.76-cm (0.3-in) offset was chosen from LaRC's numerical analysis experience. It was suggested that no greater than a tenth of an acoustic wavelength would be a sufficiently small spatial offset. Thus, a 0.76-cm (0.3-in) offset satisfies this condition for acoustic signals up to 4 kHz. Sensing probes enter the duct from either or both of the side walls. Flow measurements include pressure, temperature, and velocity profiles upstream of the liner section. Also, in-flow sound pressure levels and phases are obtained with a microphone probe equipped with a nose cone. With these measurements, both the mean flowfield and acoustic flowfields can be determined in a cross-plane of the rectangular duct.

2.2.2 *Liner Housing Section*

The liner section was designed to allow liner materials to be placed on all 4 walls of the duct. This presented a problem not found in the design of the 2-sided liner section. The previous design included a slightly wider liner housing than duct width. This allowed the liner to be supported by ledges on the sides of the liner housing while still exposing liner material to the full width of the duct. However, 4 sides cannot be lined in this manner since the over-sizing for ledges cannot physically be done if all four sides are to extend beyond the duct width. For the new liner section, 4 liner housing sections the same width as the duct sides were fabricated and welded together as shown in Figure 5. These were then joined together onto upstream and downstream flange sections. This produced a liner section that allows all four

duct walls to be lined over their entire width. However, the new design does not have the ledges in the liner housings to support the liner material. The liners were held in place using two methods: The liner was sized to fit snugly into the housing if it was rigid enough to hold its shape under some compression forces. In the case of a soft or loose liner material, a holding box to contain the liner material would have to be made out of thin metal, with a screen mesh face sheet to contain the material along the flow duct edge. For additional holding capability set screws were tapped into the housing walls to squeeze the liner even more if necessary to keep the liner in place. For the current study, use of the set screws was not needed. The sections of ceramic honeycomb liner material used in the present study fit very snug in their housings and proper bracing of the back plates prevented any movement of the liners.

Openings were also fabricated in the flange sections of the liner housing section to allow for installation of flush mounted microphones on the walls of the duct. Holes were placed on the top and bottom surfaces of the duct, upstream and downstream of the liner housing. For the present experiments, microphones were mounted flush in the duct only on the top surface as shown in Figure 1, upstream and downstream. Plugs were installed in the holes on the bottom surface.

2.2.3 Exhaust Section

An exhaust section of the flow duct was fabricated for the previous study (Ref. 1). The exhaust section is a straight duct section on the inside of the duct. The outer surface of the exhaust section was machined so that the duct termination has a thin lip at the exhaust edge. This provides about 18 cm (7 inches) of straight duct downstream of the downstream instrumentation section before exhausting into the atmosphere.

2.3 Instrumentation for Data Acquisition and Analysis

In order to obtain all the measurements for the validation of the liner prediction code, several acoustic and flow measurements were needed. Thus, several microphones, pressure/temperature probes were used to acquire the data. Also, a data acquisition system was needed to assist in acquiring, organizing and storing the large amounts of data collected. The following sections describe the instrumentation and data collection systems used in this study.

2.3.1 Axial Centerline Acoustic Measurement Probe

In addition to the acoustic measurements at the cross planes, axial centerline acoustic data was also needed. An axially traversing microphone probe was fabricated for the previous study [Ref. 1]. However, it was found that the support rods used to keep the probe centered in the duct in the original study, where the liner was mounted on one of the larger sides of the rectangular duct, could damage the ceramic liner installed now on the short walls of the duct. A new axial traverse probe was developed that supported the probe from the bottom of the duct ($Z = 0$ plane in Figure 1c). The probe is shown in Figure 6. The support in this case consisted of hanger wires with rollers on the tips extended out to the sides to maintain lateral stability of the probe in flow. However, since these wires did not have to support the probe, the pressure on the liner surfaces was minimal and the honeycomb structure of the liner did not appear to be damaged in any way by this arrangement. A 0.64 cm (0.25 in.) microphone

was mounted on the probe support. The pre-amplifier was mounted on the support structure of the probe. This extended the nose cone screen for the microphone 7.62 cm (3 inches) out in front of the support structure. The probe was mounted on an existing cylindrical support post installed on a traverse sled. This configuration allowed the centerline to be traversed from approximately 2 inches upstream of the most upstream measurement cross-plane to about 2 inches downstream of the most downstream measurement cross-plan, or about 66 cm (26 in.) total distance.

2.3.2 Instrumentation for Flow Data

Qualitative and quantitative aspects of the mean flowfield within the flow-duct were established by traversing the duct in the z-y plane at a given axial location with a combination pitot-static and thermocouple probe. In particular, this flow probe was a United Sensor type PAC-T. The thermocouple wire type was Chromium/Aluminum allowing for measurements in flows with temperatures up to 1400° F. The pressure tube portion of the probe was made from stainless steel. The stock probe was modified to fit the instrumentation box dimensions and had a 0.318-cm (0.125-in) outer diameter. Figure 7 shows a photograph of a typical probe used for flow measurements.

The total and static pressure sensed by the flow probe exited the instrumentation box via pressure lines connected to sealed steel tubes. Standard Tygon pressure tubing relayed the total and static pressures to a pair of SensSym SCX series electro-pneumatic transducers. Output from these transducers lead to an Analog-to-Digital (A-to-D) board that was connected to a Macintosh Centris 650 computer. The thermocouple wires exited the instrumentation box through a pressure tube that was sealed around the wire. The wire was then fed into a Nanmac Corp. H3 - 21 temperature indicator unit and the A-to-D board.

Positioning of the probe in two dimensions was accomplished by actuating two stepper motors. These motors were controlled by a controller that received commands from the Centris 650 computer. Both the positioning and the acquisition of the pressure/temperature data were controlled with a software program called LabView located on the Centris 650 platform. A program was written in LabView which automatically controlled the stepper motors for probe positioning and saved all data input onto the computer's hard drive. The program allowed the probe to sample data 1000 times a second while the probe was held at each position for 5 seconds. Figure 8 shows a schematic of the data acquisition system for the mean flow measurements.

The thermocouple part of the combination probe was calibrated by using a Nanmac Corp. (Model H14 - 1) thermocouple calibrator. The calibrator provided the appropriate voltage corresponding to thermocouple output for any desired temperature. The display offset was set by setting the display offset to the temperature of the calibrator output (25 degrees C). The gain of the display was then checked by verifying the display against the calibrator at several other temperatures between 0 and 150 degrees C. This verified the display accuracy well beyond the temperature ranges expected in the duct since only unheated flow measurements were made.

The pressure transducers were calibrated against a mercury manometer up to 6.88 kPa (1 psi) gauge. An electro-pneumatic transducer similar to that used for the in-flow probes was used to measure the plenum pressure.

2.3.3 Acoustic Data Acquisition System

Acoustic data were acquired with a total of six microphones: two in-duct microphones for planar measurements, two flush wall-mounted microphones, one in-duct microphone for axial centerline measurements, and one microphone outside the duct for reference. The microphone signals were sent to an HP 3667A Signal Processor where real time FFT's were performed on the time signals. The HP analyzer was also fed the electronic signal used for exciting the acoustic drivers located just downstream of the round-to-rectangular duct section. It allowed for cross-correlation computations between the speaker input and the microphones measuring acoustic signals in the duct. This provided a relative phase along with the amplitude of the acoustic pressure. This technique is critical to the analysis of signals in the presence of flow and will be discussed further in section 3.4.2. Figure 9 shows a schematic of the acoustic data acquisition system. A LabView program was also written to control the movement and data acquisition of the acoustic probes. This program, once started, would traverse a given probe throughout a measurement plane and save the acoustic data at each location on the computer's hard drive.

The acoustic measurements made in the duct cross-planes were accomplished by using a 0.64-cm (0.25-in) Bruel and Kjaer (B&K) type 4136 microphone which was provided with a probe-tube attached to the diaphragm of the microphone. Figure 10 shows a photograph of a typical in-duct, in-flow, microphone probe. The probe-tube tapers from a 0.64-cm (0.25-in) outer diameter to a 0.318-cm (0.125-in) outer diameter before turning 90 degrees from the diaphragm axis. A bullet nose cone (B&K type UA 0355) is attached to the tip of the probe end. In order to minimize flow blockage by the probe, a recently developed small diameter B&K type 2633 preamplifier was used. This pre-amplifier has an outer diameter of 0.64 cm (0.25 in).

Calibration of this microphone probe is discussed in section 3.4.1. A B&K 4136 0.64-cm (0.25-in) microphone with a bullet nose cone (B&K type UA 0385) attachment was used to acquire acoustic data along the axial centerline of the duct. Again, the nose cone allowed for the in-flow acoustic measurements. Figure 6 shows a photograph of this microphone fitted with a nose cone and attached to its stabilizing boom.

Flush wall-mounted microphones were placed upstream and downstream of the liner section, in the center of the top duct wall. These were B&K type 4133, 1.27-cm (0.50-in) microphones. A special mounting device was fabricated to allow for microphones without protection grids to be flush with the top wall of the duct and also to prevent any air leakage around the microphone. Figure 11 shows a photograph of a typical microphone with the mounting device. The flush wall-mounted ports were designed with the flexibility for allowing for a water-cooled mounting design to be used in the future for heated-flow tests.

Finally, an additional 1/2-inch diameter, B&K 4133, microphone was placed outside the exhaust section of the flow duct at $z = 0.0$, $y = -36.3$ cm (-14.5 inches, left of the duct, looking upstream) at a distance of 48.3 cm (19 in) downstream of the exhaust duct exit.

2.4 Test Liner

The test liner was of locally-reacting type and was made from a ceramic material. The material, consisting of a tubular structure, was provided by NASA LaRC. This material is referred to as CT73 ceramic liner by NASA LaRC personnel and will be referred to as CT73 liner in this report also. The test article was approximately 8.89 cm (3.5 inches) thick. It was desired that the CT73 liner have a rigid wall backing when installed in the liner housing. The rigid backing was achieved by using a 0.159mm (0.0625-in.) thick rubber gasket material with aluminum tape on one side and a 1.27 cm (0.5 in.) thick steel plate on the other. The metal tape side rested on the back side of the CT73. It was felt that this would provide a sealed, rigid-walled backing for the liner. Such a backing was used in the previous study (Ref. 1) and was found to be an adequate.

2.5 Impedance Tube

The general acoustic properties of the test liner were examined in a normal incident impedance tube as well as by testing in a flow-duct environment. The impedance tube used for these tests was a B & K 4206 Two-Microphone Impedance Tube. This impedance tube utilizes the two-microphone method of determining material impedance (see Chung & Blaser, Ref. 2). The B & K 4206 impedance tube provides impedance data for a range of frequencies simultaneously through broadband sound generated by an acoustic driver located at one end of the impedance tube. This feature allows relatively quick determination of input impedance of liner materials compared to a standing wave impedance tube which acquires data at one frequency at a time. A frequency range of 50 Hz to 6400 Hz is possible by configuring the impedance tube with two measurement tube diameters.

Since the impedance tube relies on plane wave impingement of sound onto the test sample, the tube diameter is critical to the frequency range of interest. The B&K 4206 impedance tube is provided with 10.0-cm (3.94 in.) and 2.9-cm (1.14 in.) diameter tube sections. This ensures plane wave propagation from 50 Hz to 1600 Hz with the 10.0-cm diameter tube and from 500 Hz to 6400 Hz with the 2.9 cm diameter tube. For the present impedance tests, the actual flow duct test article was used, instead of cutting a 2.9-cm-diameter test sample of CT73 to fit inside the tube. The duct test article was placed up against the open end of the impedance tube, making sure a good seal was formed at the tube/liner interface. The set-up is shown in Figure 12. Since the liner was locally reacting, sound impinging on the portion of the liner exposed inside the impedance tube is not transmitted through parts of the liner not "underneath" the sealed impedance tube/liner interface. Thus, as long as a good seal was maintained, the portion of the liner exposed under the impedance tube acts like a liner sample whose diameter is the same as that of the impedance tube. Thus the impedance of the portion of the liner exposed to the impedance tube can be obtained without cutting a separate liner sample to fit inside the impedance tube. Repeating the impedance test several times exposing a different portions of the liner underneath the tube gives an average value of the normal incidence impedance of the liner.

Figure 13 shows the absorption coefficient spectra of CT73 and the relative effect of the type of backing. Figure 14a and 14b show the normalized resistance and reactance of the liner, respectively. The liner displayed very consistent characteristics unless the exposed portion of the liner included a joint seam. This seam was the result of having to utilize pieces of the CT73 material already in hand. None of the available pieces could be cut to fit the liner section as a single piece; thus two pieces were glued together. This created a seam that can be seen in Figure 15a which shows a photograph of one of the liner inserts used in the experiments. Figure 15b shows a photo of the two liner sections installed in the flow duct. One should keep in mind that the area of the seam (approximately 0.25 x 2 inches) is relatively small when compared to the total area of the liner surface (11 x 2 inches). However, when attempting to determine the absorption characteristics of the seam, including its 0.25 inch width underneath the 1 inch diameter tube, the seam takes up a significant amount of the area in the impedance tube. Thus, the significant differences noticed in the impedance tube data presented in Figures 13 and 14 are possibly misleading in the magnitude of the effect of the seam when tested in the flow duct.

3.0 Technical Approach

3.1 Summary of Technical Approach

In the study described in reference 1, for which this facility was developed, flow and acoustic data were acquired with the liner only on one of the walls; parallel to the major axis of the rectangular duct. Further study with lining materials on both walls parallel to the minor axis was of interest. For the current study, therefore both “short” sides of the duct were lined with liner material, and flow and acoustic data were obtained upstream and downstream of the lined walls, and along the center axis of the flow duct in the region between the measurement planes.

Since acquisition of acoustic data in the presence of flow is desired, a method of extracting the acoustic signal from the overall flow noise must be used to obtain useful acoustic data. In some cases, simply increasing the amplitude of the acoustic source is adequate to maintain a reasonable signal to noise ratio. However, due to limitations of the acoustic drivers and the desire to maintain a precise level at the liner leading edge, this is not always an option. Thus, a method of separating the acoustic noise from the flow noise must be used to extract or reduce the acoustic signal buried in the unwanted flow noise. Often one has to resort to this technique at higher flow speeds. The method used in this experiment uses the cross-correlation between the microphone signal and the electronic signal fed into the acoustic drivers. A discussion of the method was presented in reference 1 and is also summarized in section 3.4.2.

Again, the presence of flow requires a careful choice of hardware to obtain the acoustic data with only minimal flow intrusion. The probe microphone was developed specifically for this task. This type of instrument has been used by many researchers and also in the previous study in this facility. The probe tube, which was described earlier, essentially consists of a small tube with an opening that allows the acoustic signal to enter and propagate down the length of the tube to the microphone's pressure sensing head. However, the probe tube does

affect the acoustic signal to some extent, and therefore the probe tube must be calibrated. A calibration was performed that documented the effect of the probe tube on the acoustic signal amplitude and phase for different frequencies, SPL levels, and mean flow Mach numbers. A more detailed discussion of the calibration procedure is given in section 3.4.1. The calibrations were used to back out the true complex pressure from the signals recorded with the probe tube microphone set-up.

3.2 Experimental Set-up

General details of the rectangular flow-duct facility developed for the present program were provided in section 2.0. In the interest of clarity, a short summary of the precise test setup used to evaluate liner performance in the present study appears below. These tests were carried out in GTRI's Liner Flow Duct Facility. The flow-duct configuration was set-up for downstream acoustic propagation, i.e., the acoustic liner section was placed downstream of both the acoustic source and the air plenum. The leading edge of the liner section was located approximately 73.0 cm (28.75 inches) downstream of the acoustic drivers. An instrumentation section, which can measure flow and acoustic properties in two-dimensional duct cross-planes, was located just upstream of the liner section. Likewise, a similar instrumentation section was located just downstream of the liner section. Figure 1 shows a schematic of the flow-duct. The left side (looking upstream) of each instrumentation box sections was fitted with acoustic probes, while the right side of the instrumentation sections was equipped with combination pitot-static/thermocouple probes. Both of these probes are described in detail in section 2.3 along with the pertinent information regarding data acquisition and instrumentation.

3.3 Mean Flow Measurements

The mean flow parameters in the rectangular duct were measured by a combination pitot-static/thermocouple probe which traversed two planes perpendicular to the x-axis of the duct. In this way, mean pressure, velocity, and temperature data were obtained to accompany acoustic data taken in the same plane. One measurement plane was located approximately 19.05 cm (7.5 inches) upstream of the leading edge of the acoustic liner while the other plane was located approximately 11.43 cm (4.5 inches) downstream of the trailing edge of the acoustic liner. These dimensions correspond to acoustic measurement planes 1 and 3, respectively. A more detailed description of the probe's data acquisition system was provided in section 2.3. Flow data can be acquired at any prescribed point in the measurement plane. Typically, flow profiles were taken across the major and minor axis of the duct at both measurement locations.

Figures 16 - 18 show the upstream and downstream velocity profiles for each individual Mach number. As can be seen, the liner seems to affect the downstream profile. However there also seems to be some difference between the upstream profiles for the liner and hard wall cases. This is believed to be due to electronic noise that was not eliminated from the data acquisition loop during hard wall testing. Figures 19 and 20 show typical mean flow profiles at a given plenum pressure for hard-wall cases and lined wall cases. For the lined wall cases, an acoustic liner was installed on both side walls of the liner housing section. The non-dimensional velocity profiles suggest a turbulent, fully developed flow (i.e., the profiles have shape factors ~ 1.1 , much closer to a turbulent velocity profile than a laminar

one; see White, Ref. 3) for the upstream plane as well as the downstream plane. Furthermore, note that the boundary layer for the lined case at the downstream location shows an increased velocity defect compared to the same upstream region.

3.4 Calibration of Probe Microphones

Sound propagation through the tube of the probe microphone used in the present study (described in section 2.3.3) modifies the true acoustic signal. To derive absolute values of sound pressure level (SPL) and phase, a calibration must be performed to correct the probe microphone measurement to a "true" value. This section will describe the methodology that was used to calibrate the particular probe microphone used in this study. In addition, calibration results will be presented for cases with and without the mean flow.

3.4.1 Method of Calibration

A calibration must provide a correction that can be added to the measured value to give a "true" sound pressure level (SPL) and phase. One can look at it as the correction that removes the effects of the probe tube. As with any calibration, a "true" signal is needed for comparison. In this case, a conventional B & K 4136 microphone of known frequency response and equipped with a nose cone was placed just downstream of a nozzle exit for measuring acoustic signals in flow. Acoustic drivers placed upstream of the nozzle produced an acoustic signal, at a particular SPL, as measured at the "true" microphone. The phase difference between the input electronic signal to the drivers and the microphone was also measured. The probe microphone was then placed in the same location and another similar measurement was made at the same conditions. The SPL and phase values of the probe microphone and the "true" microphone were subtracted to find the correction factors for each condition. These corrections were applied to probe microphone signals to extract the "true" acoustic signal.

The test matrix for the calibration of a probe included the frequency range of 500 - 6000 Hz in steps of 500 Hz, Mach numbers of 0.0, 0.1, 0.2, 0.3, and 0.4, and SPLs of 80, 90, 100, 110, and 120 dB. Several frequencies were measured at one time by use of a special function on the function generator that would produce a signal containing a multiple of tones (referred here after as "multi-sine function"). This reduced the workload by a factor of 5 since up to 5 frequencies could be evaluated at once. It should be noted that the acoustic signal was extracted from the flow using the method discussed below for the measurements that were made in the presence of flow. Figures 21 and 22 are sample calibration correction values for level and phase for one of the probes used in the experiments.

To avoid problems of interpolating between frequencies, only frequencies of 500, 1000, 1500, 2000, and 2500 Hz were investigated during the duct flow tests. The Mach number portion of the correction is not so simple. Even though the tests were conducted only for duct mean flow Mach numbers of 0.0, 0.1, 0.2, and 0.3, the Mach number was not constant near the walls of the duct. Thus, to correctly apply the calibration, the local Mach number of each acoustic measurement had to be found. However, this data was available from the velocity profiles taken during each test. During post processing, the frequency and local Mach number of the acoustic were used to correct the data. To appropriately match Mach number, a linear interpolation was performed to estimate a correction for Mach number that

was not an exact calibration point. For example, if a local flow Mach number of 0.23 was measured at a given location, the calibration data for Mach numbers of 0.2 and 0.3 would be interpolated to find an estimated calibration value at $M = 0.23$. This value would then be applied to the acoustic measurement.

This accounted for flow differences throughout the measurement, but the calibration of the probe tube varied day to day with temperature changes as well. This was corrected in a separate one point calibration. Acoustic measurements were made in the same location under the same conditions with the axial microphone probe at the correct x location of the plane (which coincides with the center point on a traverse across the plane by the probe microphone), and the planar measurement probe tube in the center of the plane. Since these two measurements should be the same, the probe tube data was shifted such that the center measurement point matched the axial probe value. This corrected the entire plane of data for temperature variations.

A representative calibration process is presented in Figure 23. The calibrations shifts are exaggerated to convey the correction process. The large black circle represents a measurement at center point by the axial microphone. The points in curve 'A' are the measured values across a given plane with the probe microphone. Curve 'B' represents the data calibration for flow. The Mach number for each point is found from the mean flow data and the corresponding calibration value is used to correct for flow. Notice how all points are affected individually since each point may have its own Mach number. However, the center point and the "true" value are not necessarily the same after this adjustment because of temperature and SPL level variations. This is corrected by shifting all the planar data by the difference between the center point of the plane and the "true" axial data point since these two points should have the same value. This methodology was used to correct both the SPL and phase of the plane data to a "true" value. Keep in mind that the data shown in Figure 23 is not associated with any real calibration values, it is only for illustration purposes.

3.4.2 Eduction Technique for Rejecting Flow Noise

As mentioned earlier, when attempting to measure acoustic signals in a mean flow environment there can be significant difficulties if the acoustic signal is buried beneath flow noise. In general, there are two options: (1) the acoustic signal amplitude can be increased such that the resulting signal-to-noise ratio is high, or (2) a post-processing method of educing the acoustic signal can be performed. The following is a description of the method employed in all the work where flow was involved, including the duct flow measurements and in the calibration of the microphone probes.

3.4.3 Methodology for Rejecting Flow Noise from In-flow Acoustic Measurements

In general, the flow over a microphone equipped with a nose cone produces the so-called self-induced noise. Furthermore, any noise in the duct that is produced aerodynamically will be picked up by the probe microphone. One way to measure the acoustic signal that is contaminated with the self-induced and other obtrusive noise is to cross-correlate the input electronic signal fed to the acoustic drivers with the signal from a microphone, either in the flow or flush mounted on the duct wall. In this way, the cross-power spectrum can be obtained which should contain only the information that is *coherent* between the driver signal

and the microphone. Figure 24 shows schematically how the signal path is interpreted along with a nomenclature of relevant terms.

Let $x(t)$ be the electronic signal fed to the acoustic driver, and $u(t)$ be the true acoustic signal that is contaminated with flow noise $n(t)$. Let $y(t)$ be the total signal measured by the microphone. The autospectra corresponding to signals $u(t)$, $x(t)$, $y(t)$, and $n(t)$ are denoted by $G_{uu}(f)$, $G_{xx}(f)$, $G_{yy}(f)$ and $G_{nn}(f)$, respectively. Likewise, the cross-spectra between $x(t)$ and $y(t)$, $x(t)$ and $u(t)$, $y(t)$ and $n(t)$, are defined as $G_{yx}(f)$, $G_{ux}(f)$, and $G_{nx}(f)$, respectively. For the sake of clarity, the frequency term will not be used in the following text. Thus $G_{yx}(f)$ will be denoted by G_{yx} , etc. An overbar denotes a time average.

The objective is to determine G_{uu} , which is the autospectrum associated with the signal reaching the microphone. As shown below, G_{uu} can be *deduced* by obtaining G_{yx} if G_{xx} is known.

$$G_{yx} = (S_u + S_n) S_x^* = G_{ux} + G_{nx} \quad (1)$$

$$\overline{G}_{yx} = \overline{G}_{ux} + \overline{G}_{nx} = \overline{G}_{ux} \quad (2)$$

Since $x(t)$ and $n(t)$ are unrelated, after many averages, $\overline{G}_{nx} = 0$

now

$$H(f) = \frac{S_u(f)}{S_x(f)} = \frac{S_u S_x^*}{S_x S_x^*} = \frac{G_{ux}}{G_{xx}} \quad (3)$$

Also

$$H(f) = \frac{S_u(f)}{S_x(f)} = \frac{S_u S_u^*}{S_x S_u^*} = \frac{G_{uu}}{G_{xu}} \quad (4)$$

From (3) and (4):

$$\frac{\overline{G}_{ux}}{\overline{G}_{xx}} = \frac{\overline{G}_{uu}}{\overline{G}_{xu}} \quad (5)$$

From (2) and (5):

$$\therefore \overline{G}_{yx}^2 = \overline{G}_{xx} \overline{G}_{uu} \quad (6)$$

From (2) and (6):

$$\overline{G}_{xy}^2 = \overline{G}_{xx} \overline{G}_{uu} \quad (7)$$

$$\overline{G}_{xy} = (\overline{G}_{xx} \overline{G}_{uu})^{1/2} \quad (8)$$

$$\therefore 10 \log [\bar{G}_{xy}] = \frac{1}{2} (10 \log \bar{G}_{xx} + 10 \log \bar{G}_{uu}) \quad (9)$$

$$\therefore \text{SPL}_{uu} = 10 \log \bar{G}_{uu} = 20 \log [\bar{G}_{xy}] - 10 \log \bar{G}_{xx} \quad (10)$$

Thus the sound pressure levels associated with the electronic signal, i.e., SPL_{uu} , can be separated from the contaminated signal, i.e., $10 \log G_{yy}$, by using equation 10. Examples of the power of this reduction technique can be found in Ref. 1.

4.0 Measured Data for Code Validation

4.1 Summary of Measured Data

Table 1 provides a summary of data acquired. Each box in the test matrix represents a test condition. At each test condition, axial acoustic data, cross-plane acoustic data, and mean flow data were acquired. These data have been provided to NASA Langley Research Center (point of contact: Mr. Mike Jones, email m.g.jones@larc.nasa.gov).

Table 1. Summary of Data Acquired

Mach number	Liner Center row	Liner Off center rows	Hardwall Center row	Hardwall Off center rows
0.00	Yes*	Yes	Yes*	Yes
0.10	Yes	No	Yes*	No
0.20	Yes, S	No	Yes	No
0.30	Yes, S	No	Yes, S	No

Axial data acquired at all conditions.

Yes = Data acquired

No = Data not taken

* = Repeat data set available

S = Suspect Data (some frequencies)

4.2 Typical Duct Flow Measurements

As mentioned above, acoustic and flow pressure measurements were made for all test configurations. This included pitot/temperature probe profiles across the major and minor axis of the duct at the upstream and downstream measurement planes, x-axis acoustic complex pressure measurements, and acoustic complex pressure measurements at 2 cross planes upstream and 2 cross-planes downstream of the liner section. In addition, the input signal to the acoustic drivers and acoustic data at two flush-mounted microphones (one upstream and one downstream of the liner section) and at one reference microphone outside the duct were also recorded. The outside microphone was located at a distance of 48.3 cm (19 inches) downstream of the duct exit at a polar angle of 38° with respect to the flow

direction, and in the plane of the major axis. The flush mounted microphones and reference microphone were mainly used for reference purposes and thus the discussion will focus on the cross-plane acoustic and pressure measurements and the axial measurements along the x-axis.

There are 4 measurement planes, two upstream and two downstream of the liner section. The most upstream plane located 7.5 inches upstream of the leading edge of the liner is designated plane 1. Plane 2 is located 0.3 inches downstream of plane 1. Both of these planes are upstream of the liner section. Planes 3 and 4 are the two measurement planes downstream of the liner section. Plane 3 is 4.75 inches downstream of the trailing edge of the liner, with plane 4 located 0.3 inches downstream of plane 3. For future reference, unless otherwise stated, a set of measurements at one test condition will contain acoustic pressures along the x-axis, acoustic pressures across the major axis of the duct at the 4 measurement planes, and pitot/temperature measurements at one measurement plane upstream of the liner section, and one downstream. It was assumed that the steady flow static and total pressures would not significantly change over the 0.3 inch shift between planes 1 and 2, and 3 and 4, thus the steady flow measurements were only taken at planes 1 and 3. In addition, for some test cases, acoustic measurements were made across the duct at 0.33 inches above the major axis and 0.5 inches below the major axis.

Table 1 shows the matrix of test conditions where data sets were obtained. The Mach number is the nominal duct centerline Mach number. The label "Liner" refers to the duct configuration with the two short (2.0 in.) sides of the liner housing section lined with the CT-73 material. Hard wall plates were installed on the other two sides of the liner housing section. Similarly, the label "Hard Wall" indicates that hard wall plates were installed in all four of the available liner housing sections. The other two labels, namely, "Center" and "Off Center" refer to planar acoustic data taken along the major axis, and taken along lines parallel 0.33 inches above and 0.5 inches below the major axis, respectively. For all test conditions the acoustic drivers were fed a "multi-sine" electronic signal to produce tones simultaneously at 500, 1000, 1500, 2000, 2500 Hz. The cut-on frequency for the first higher order mode corresponding to the width of the duct is calculated to be 1416 Hz (at temperature, $T=283$ K). Similarly, the cut-on frequency for the first higher order mode corresponding to the smaller dimension of the rectangular duct is at 2831 Hz. The first higher order mode in the shorter direction is 3320 Hz. Thus 500 and 1000 Hz are expected to correspond to plane waves, while all the frequencies should be planar in the shorter dimension of the rectangular duct. A much larger list of duct resonant frequencies is given in Ref. 1. The electronic signal was generated in such a way as to produce nominally 110 dB SPL for each tone at the center of plane 1.

4.2.1 Measurement Locations

As mentioned above, complex acoustic pressures were measured across the duct. Physical limitations of the probe microphones and traverse system prevented traversing completely across the duct from one wall to the other. The probe microphones could traverse about 3.7 inches of the 4.7 inch duct width. Measurements were made every 0.15 inches from the near wall where the probe entered the duct to 3.7 inches across ($y = 0$ inches at the near wall, $y = 4.7$ inches at the far wall). This was the case at all 4 measurement planes. The pressure

probes were able to traverse nearly all of the width of the duct. Measurements were made at 0.15 inch intervals across the width. The axial data was acquired from 2 inches in front of plane 1 to slightly behind plane 4, in steps of 0.5 inches for most cases. For some of the early hard wall tests, the traverse began at plane 1 and again data was acquired at 0.5 inch intervals until plane 4 was reached. Plane 1 was located 7.5 inches upstream of the liner leading edge, and plane 3 was located 4.5 inches downstream of the liner trailing edge. Planes 2 and 4 were 0.3 inches behind planes 1 and 3, respectively.

4.2.2 Typical Hard Wall Measurements

Measurements were first made with hard wall sections installed in all four liner housings. Data were taken at the four Mach numbers mentioned. Similar sets of data were taken at the same conditions with the liner material installed in the liner housings on the 2 short sides of the rectangular duct. The data presented below will be of the following format. Each symbol on a plot represents an acoustic measurement at the location indicated in the plot. The physical dimensions are non-dimensionalized as follows. The x-dimension (streamwise direction) is non-dimensionalized by the liner length of 11 inches. The y (parallel to the major axis) and z (parallel to the minor axis) dimensions are non-dimensionalized by their respective duct dimensions of 4.7 and 2.0 inches.

Each frequency is plotted separately for clarity. For the plane data, SPL and phase are plotted versus location. Data for different Mach numbers are shown on the same plot for comparison. It should be noted that only corrected SPLs and phases are plotted. They are corrected according to the calibration value associated with the local Mach number at the measurement location and the frequency of interest. The data in the cross-planes are also extrapolated to the far wall of the duct in the region between $y = 3.7$ inches to $y = 4.7$ inches range. A second-order polynomial fit was generated from the existing data using the least squares method. This polynomial was then used to extrapolate the data to the far wall for given y values.

The figures are arranged as follows. Each figure contains plots of either SPL or phase of a particular frequency. There are 5 plots in each figure, the axially traversed data and that acquired in the four planes alluded to earlier. Each plot contains 4 curves of data, one for each Mach number. Thus, the effect of Mach number can be seen on each individual plot. The geometry referred to by the axes in the figures corresponds to the geometry sketched in Figure 25. Figures 26 and 27 show the 500 Hz data with hard wall installed. Figures 28 and 29 show the 1000 Hz data with hard wall installed. Figures 30 and 31 show the 1500 Hz data, Finally, figures 32 and 33 show the 2000 Hz data and Figures 34 and 35 the 2500 Hz data. A similar pattern is followed for the lined wall data. Figures 36 through 45 show the acoustic data obtained with the 2 short sides of the duct lined in the liner section. The data shown in Figures 26-45 appears in a tabulated form in Appendix A. The same data can be obtained in an electronic form by contacting Mr. Mike Jones at NASA Langley Research Center.

4.2.3 Discussion of Suspect Data

This data was acquired for the validation of the prediction code being developed by Dr. William Watson at NASA LaRC. Since this task was primarily for acquisition of data for the

validation of the code, most of the interpretation of the results has been left to NASA LaRC. These data have been archived here for the use of other researcher developing similar more advanced liner impedance prediction codes. However, as mentioned briefly above, and listed in Table 1, some data points were "suspect." During the data acquisition, it was noted that the acoustic flow probes resonated at certain frequencies. A resonant frequency appears around 500 Hz. Since there is a natural resonant peak around 500 Hz, the acoustic signal generated by the driver can appear coherent with this resonance. This makes the eduction of the signal at this frequency nearly impossible.

At lower flow speeds, this resonance did not appear to have an effect on the measured signal. Even at Mach 0.3, the hard-wall case appears reasonable. However, in the lined case, this data could be corrupted by this interaction for several possible reasons. First, the lined case used a different probe attachment than the hard wall case in the upstream measurement section. This was because the original probe was destroyed during a malfunction of the traverse system. The resonance near 500 Hz is more significant for the second probe. Thus as flow Mach number is increased, the data appears somewhat erratic even when the signal is educed.

Downstream of the liner, the same problem was encountered for a different reason. The signal amplitude was reduced significantly because of the attenuation by the liner. Thus, as the flow noise increased and the natural resonances of the probe tube increased, they began to drown out the acoustic signal. Since the resonances were at the same frequencies as the acoustic signal, the eduction process did not totally separate the acoustic signal from the flow. In the hard wall case, it is believed that the signal was significantly louder than the flow induced noise and thus the acoustic signal was still dominant even though there were resonances in the probe tube at the same frequency. These problems were verified by examining the coherence between the input signal to the acoustic drivers and the measured signal at the probe. It is also believed that the number of averages used in the experiment played a role in the low coherence values. The number of averages used here (64 averages) was sufficient for the hard wall data. The same number was used in the lined cases. Unfortunately this number was not sufficient for the eduction of the extremely attenuated levels downstream of the liner. Retaking the data with a higher number of averages was considered, however the time required to take data with enough averages to make a significant difference in the signal quality was not feasible at the late stage of the program, especially since it was believed that improvement would possibly be minimal. For these reasons one should exercise caution in using the data for the lined case at $M = 0.3$ and some of the frequencies at $M = 0.2$.

5.0 References

- 1) Ahuja, K. K. and Gaeta, R. J. Jr. *A Unique Test Facility to Measure Liner Performance With a Summary of Initial Test Results.* NASA Contractor Report 201667, March, 1997.
- 2) Chung, J. Y. and Blaser, D. A. *Transfer Function Method of Measuring In-Duct Acoustic Properties: I. Theory* Journal of the Acoustic Society of America, Volume 68, No. 3, Sept., 1980.
- 3) White, Frank M *Viscous Fluid Flow* McGraw-Hill, Inc., 1974.

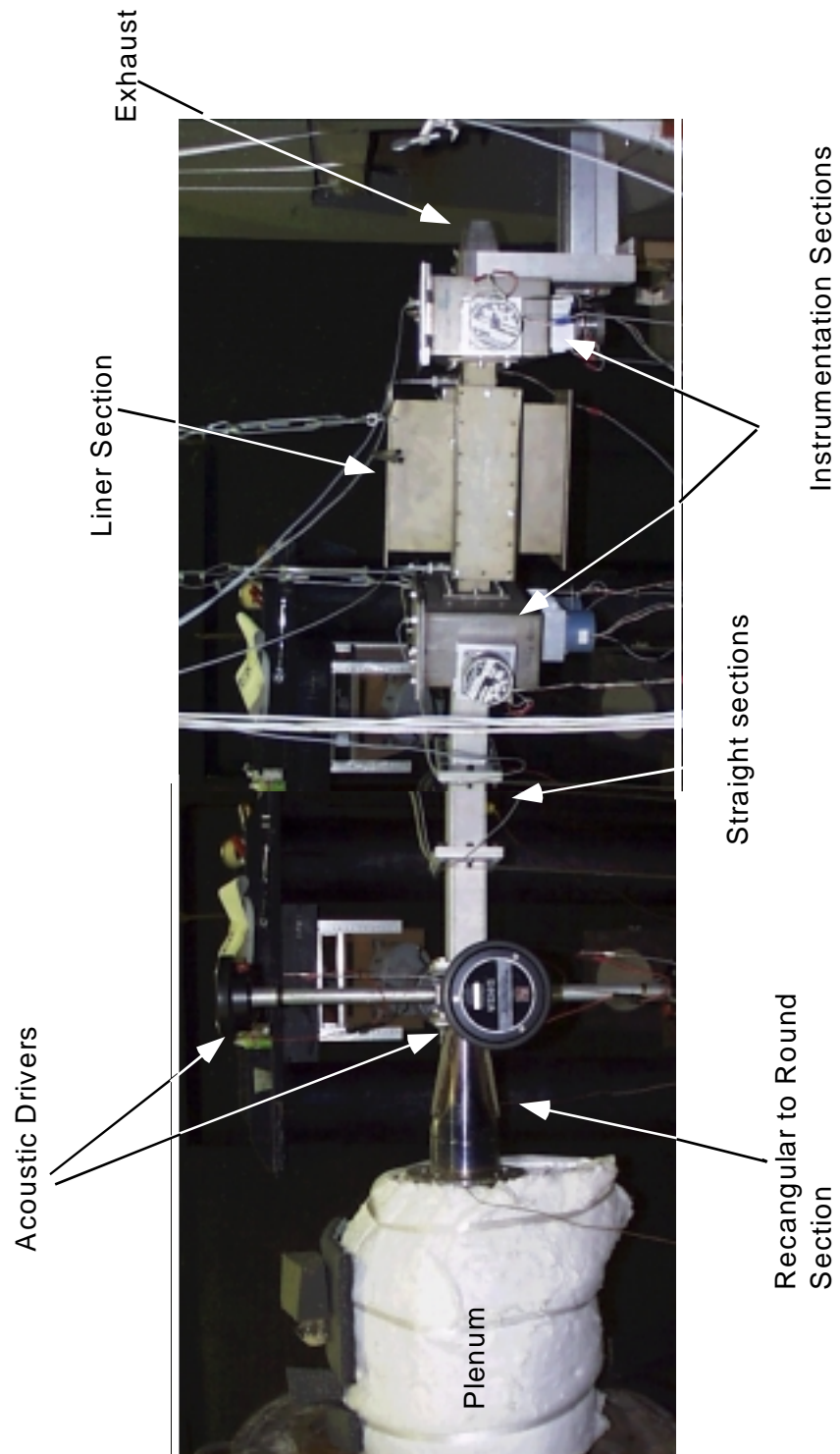

Figure 1a. Photo of flow duct facility.

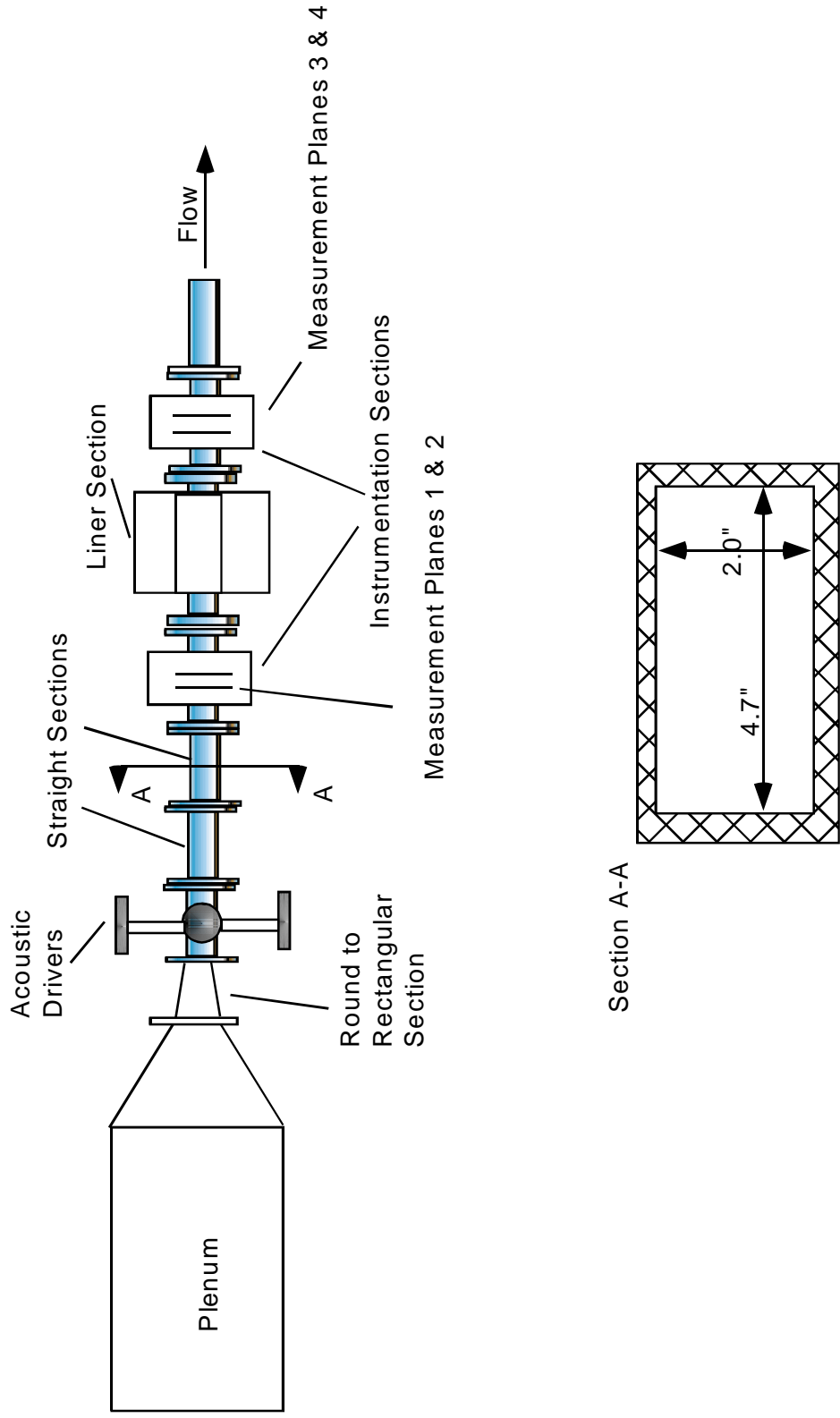
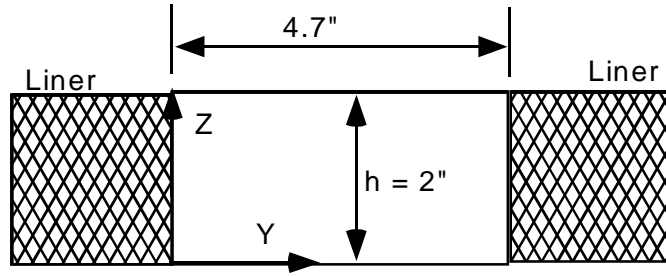
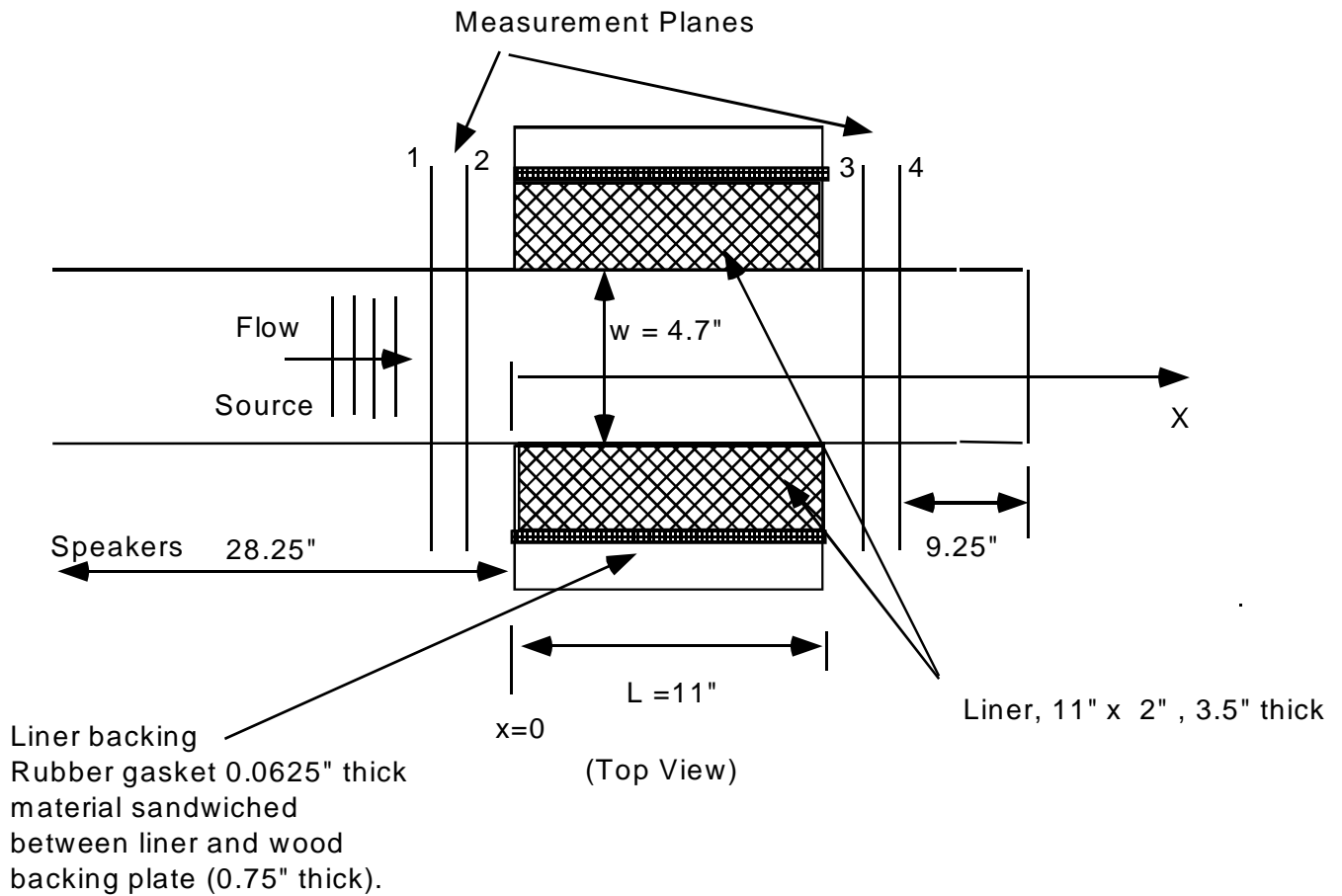

Figure 1b. Schematic of flow duct facility.



(Looking Upstream)



All location data is non-dimensionalized by the appropriate dimension
 $x/L = x/11"$ (liner section length)
 $y/w = y/4.7"$ (width)
 $z/h = z/2"$ (height)

Figure 1c. Schematic of liner section of flow duct facility.

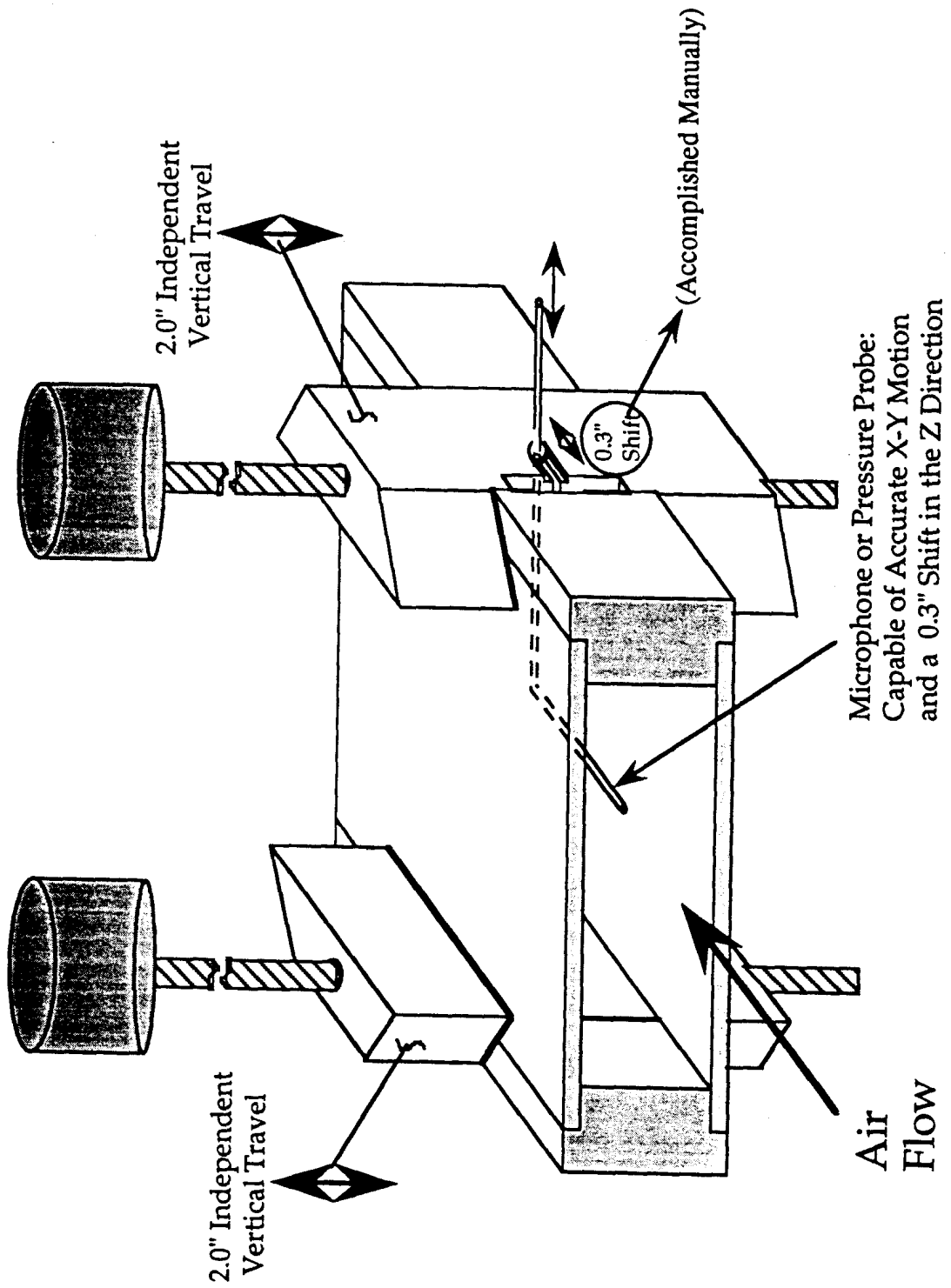

Figure 2. Schematic of microphone and pressure probe traverse system.

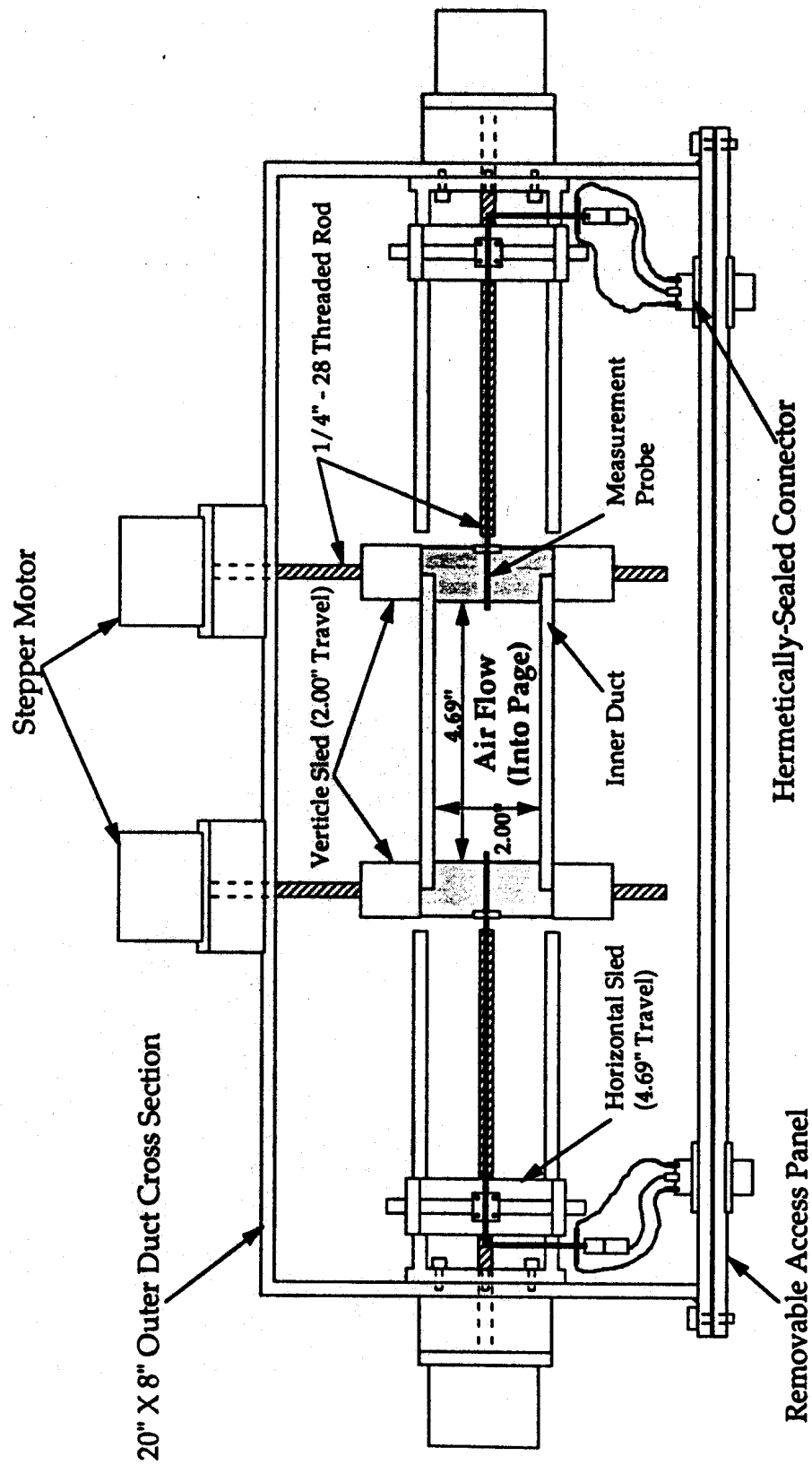

Figure 3. Cross-sectional schematic of instrumentation box.

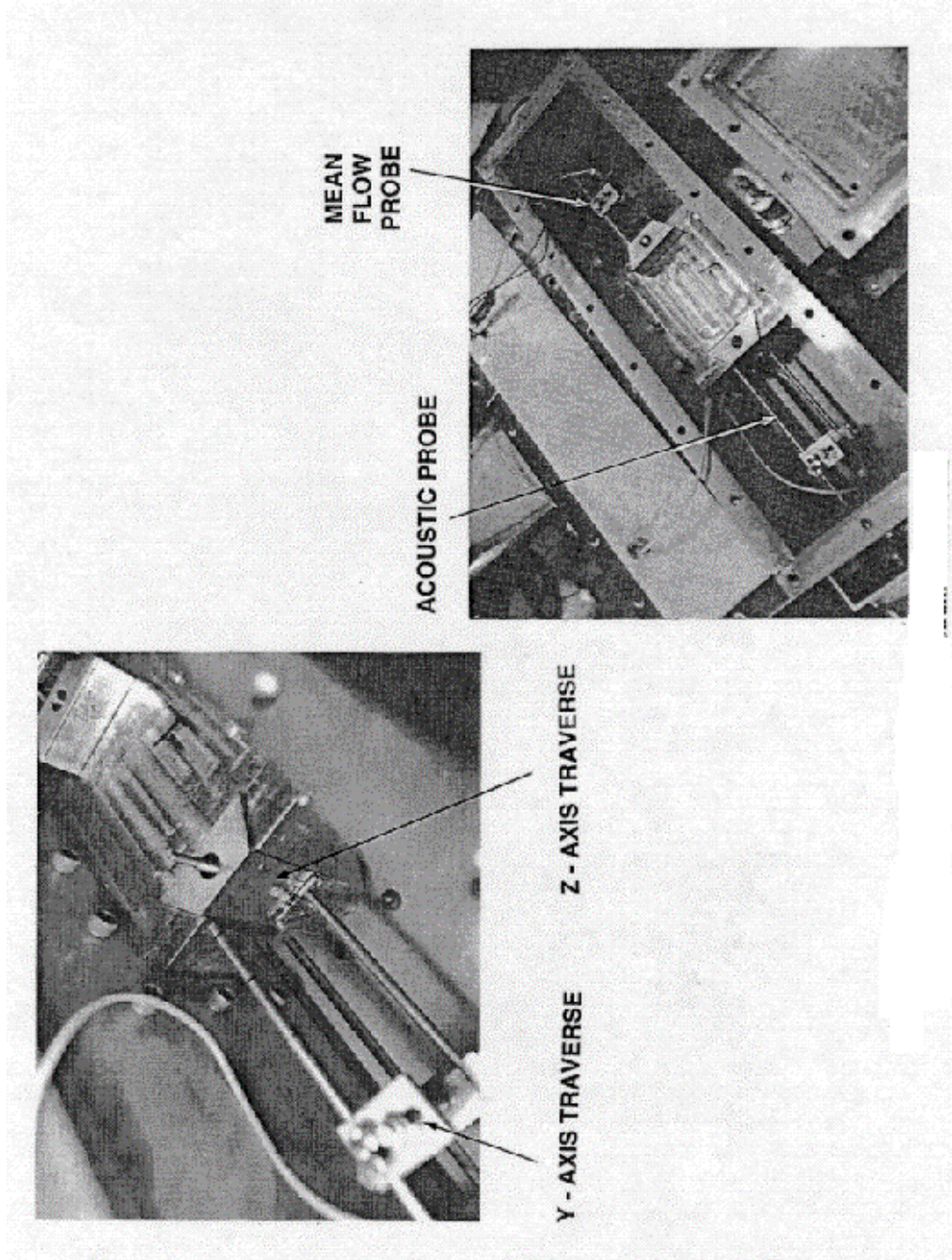

Figure 4. Inside view of instrumentation traverse box.

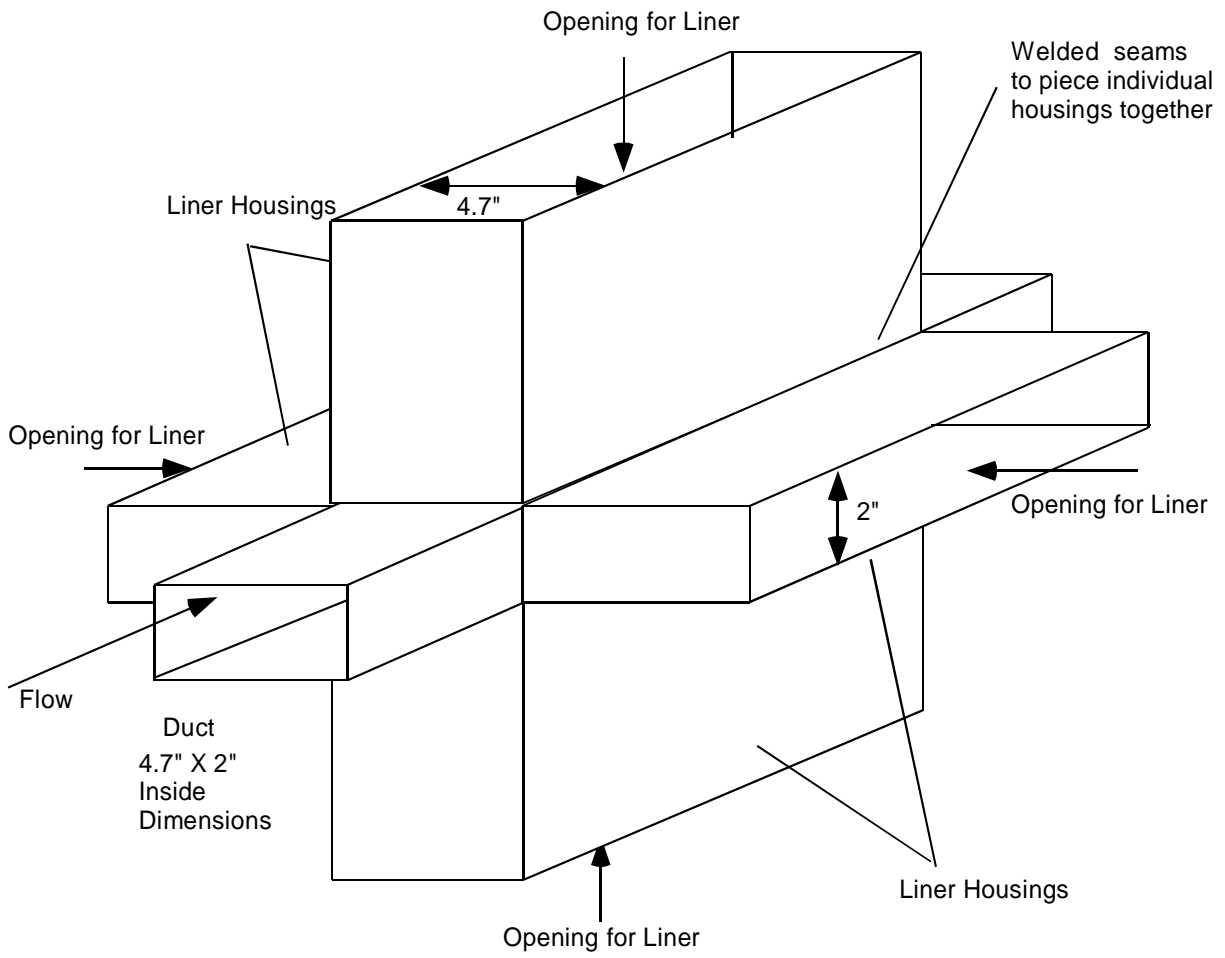

Figure 5. Liner housing schematic.

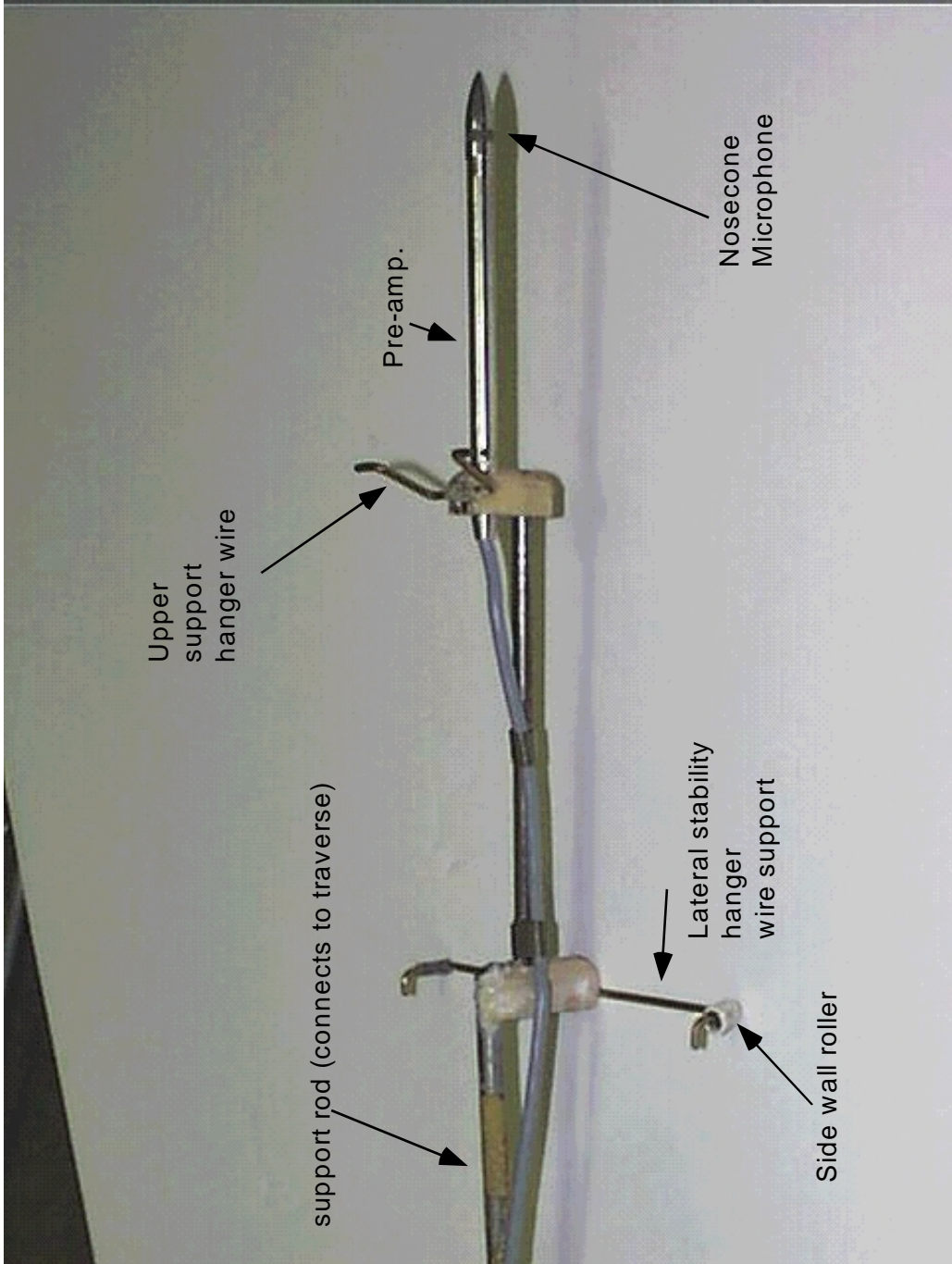

Figure 6. Axial acoustic measurement probe.

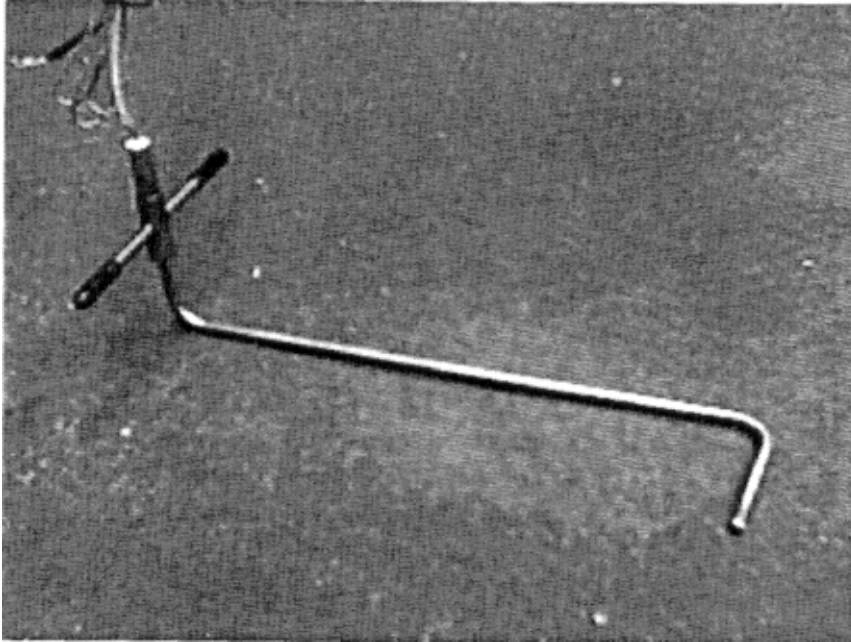

Figure 7. Pressure probe used for flow measurements.

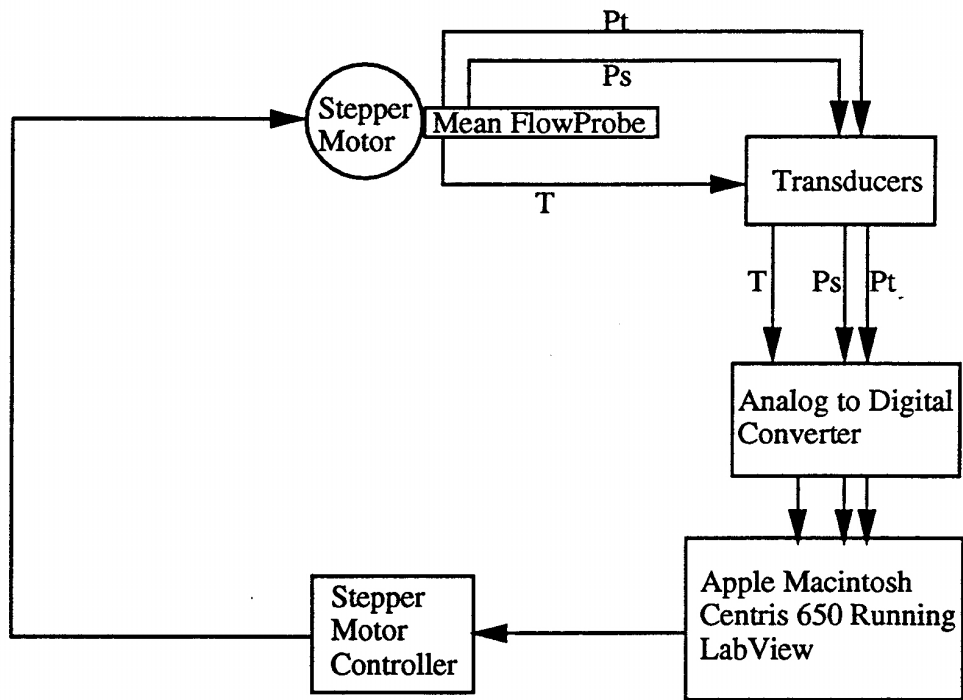

Figure 8. Schematic of mean flow data acquisition.

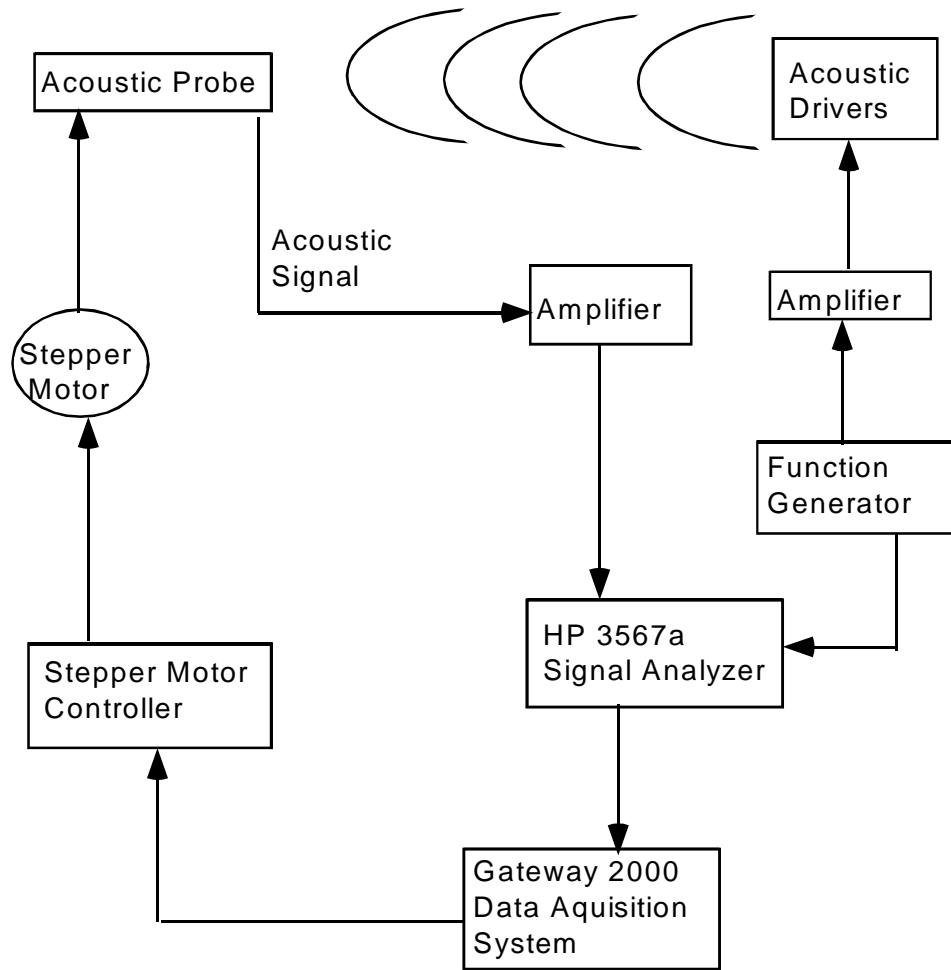

Figure 9. Acoustic data acquisition schematic.

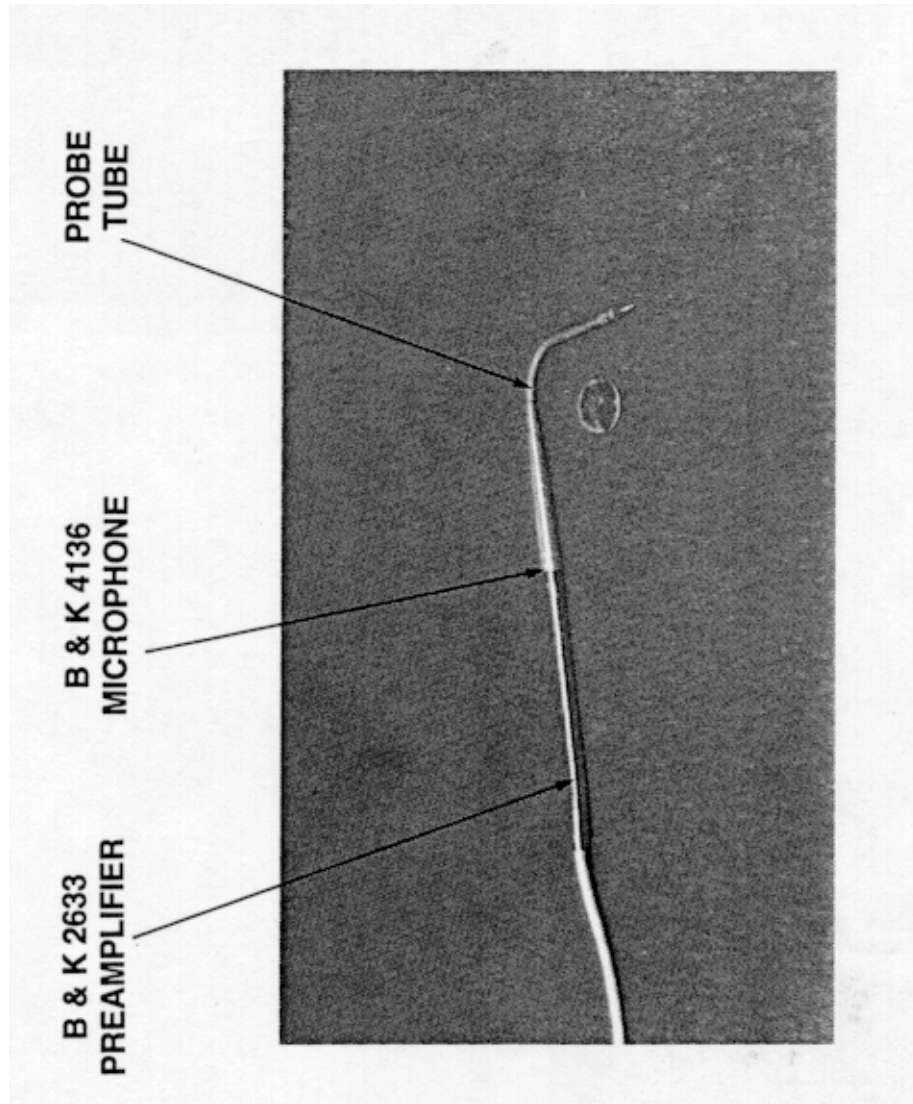

Figure 10. Microphone probe used in acoustic measurements.

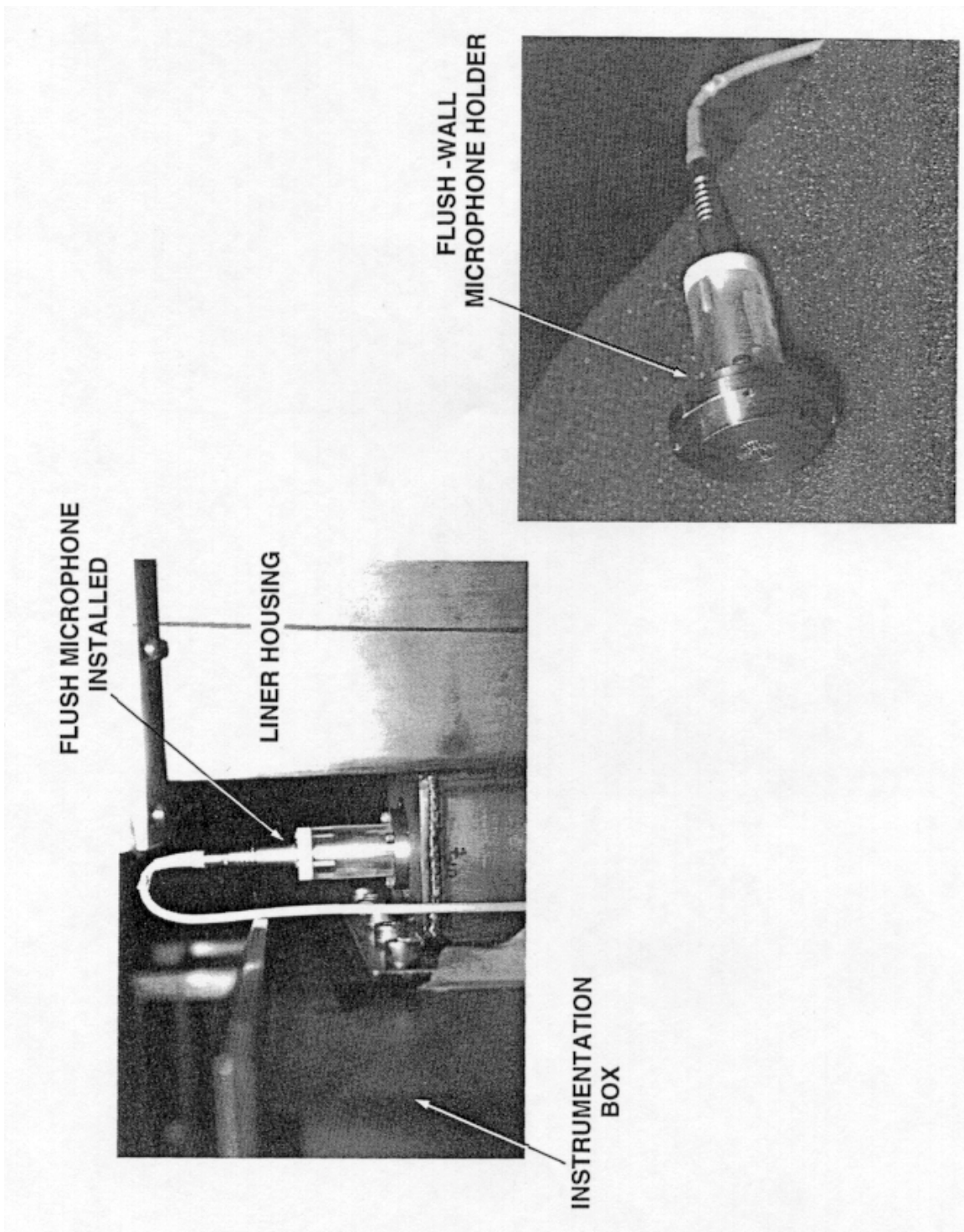

Figure 11. Photo of flush mounted microphone.

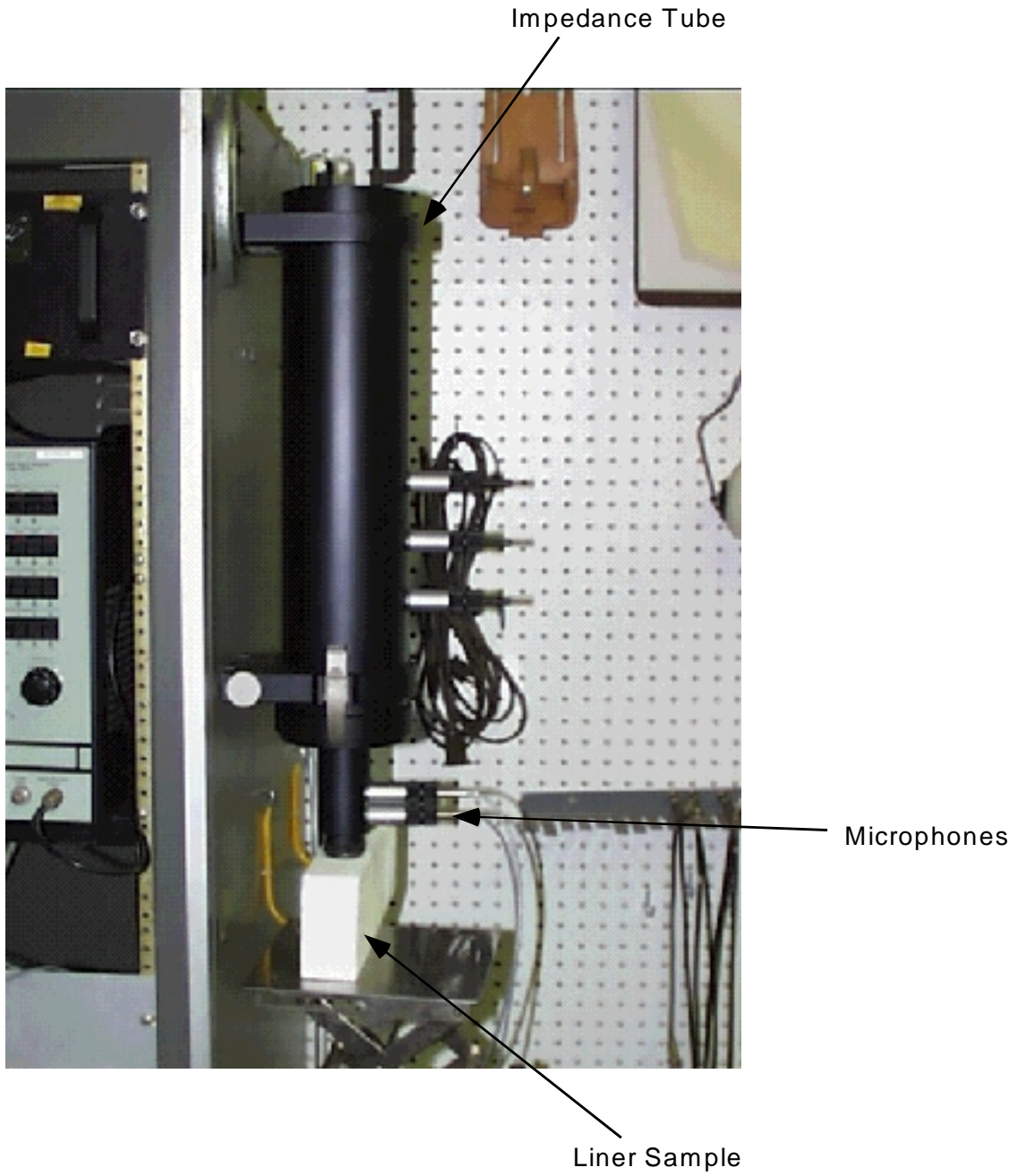
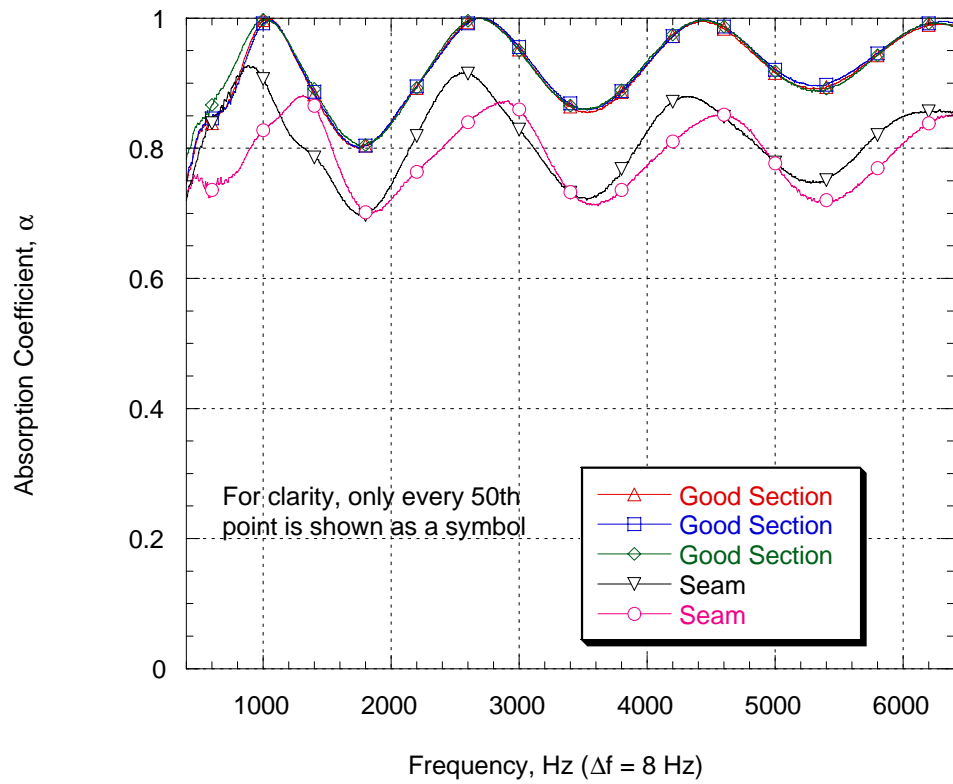
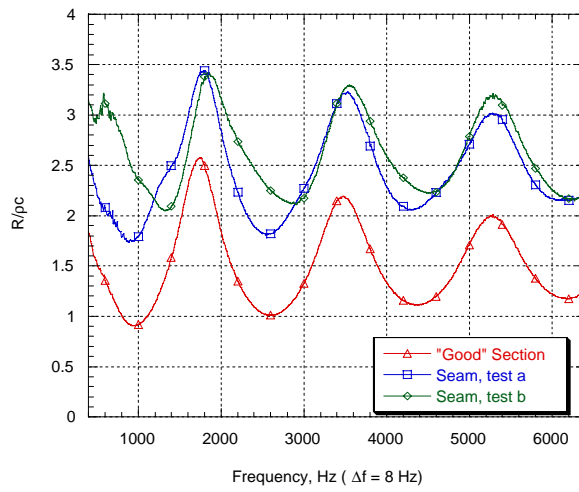

Figure 12. Impedance tube set-up used for normal impedance tests.



Normal Impedance tests of ceramic liner used in flow duct measurements
(test CL 9/1/98)

Figure 13. Absorption coefficient calculated from impedance tube tests.



Normal Impedance tests of ceramic liner used in flow duct measurements
(test CL 9/1/98, CT 9/2/98)

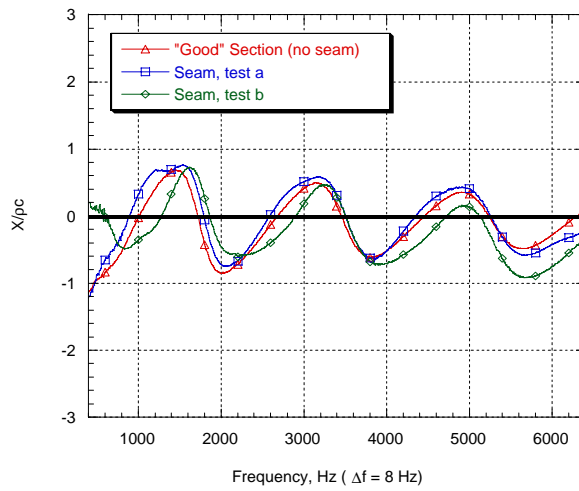

Normal Impedance tests of ceramic liner used in flow duct measurements
(test CL 9/1/98, CT 9/2/98)

Figure 14. Resistance and reactance calculated from impedance tube tests.

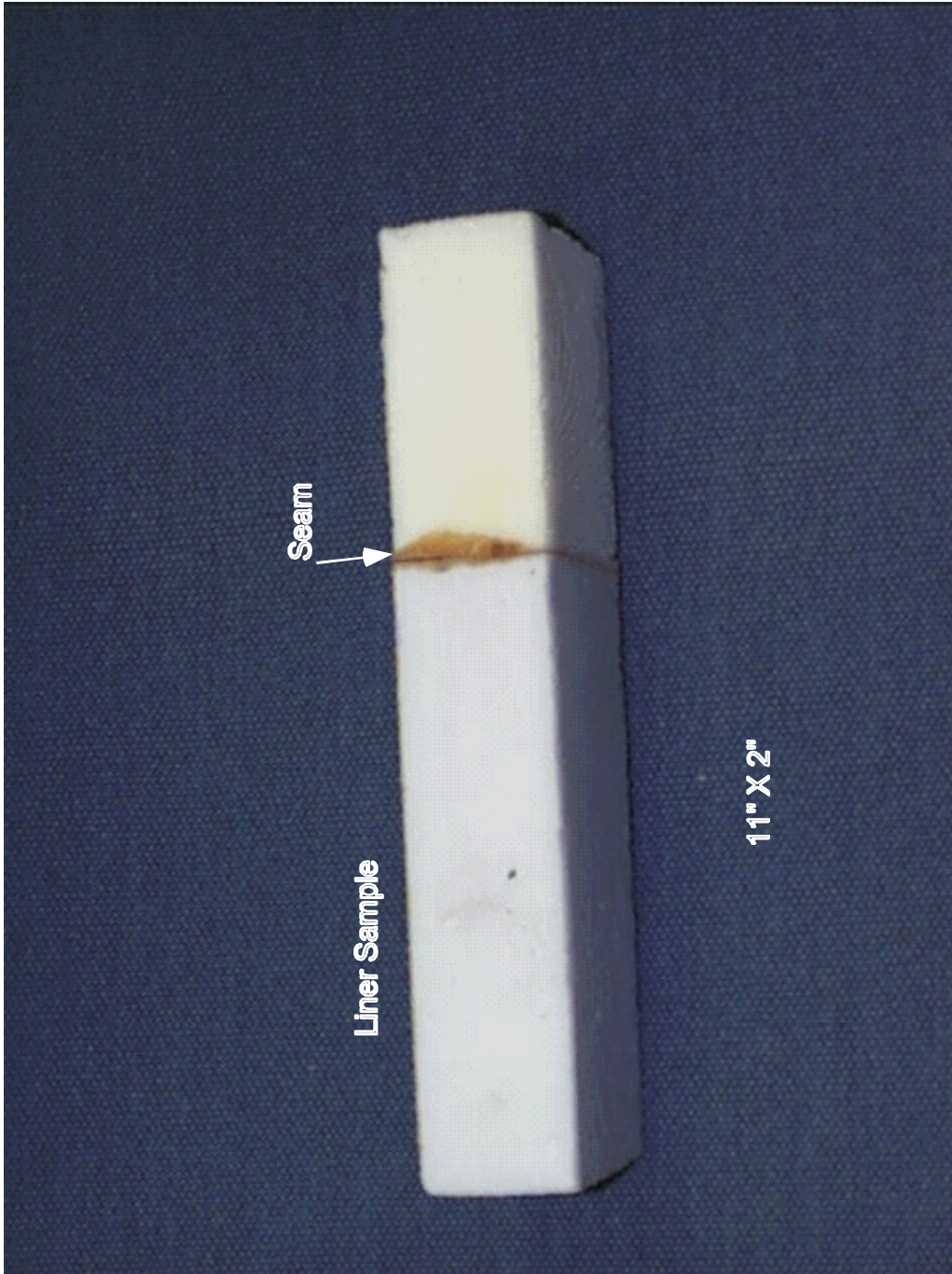

Figure 15a. Photo of liner used in experiments.



Figure 15b. Photos of flow duct with liner installed on side walls (looking upstream from exit).

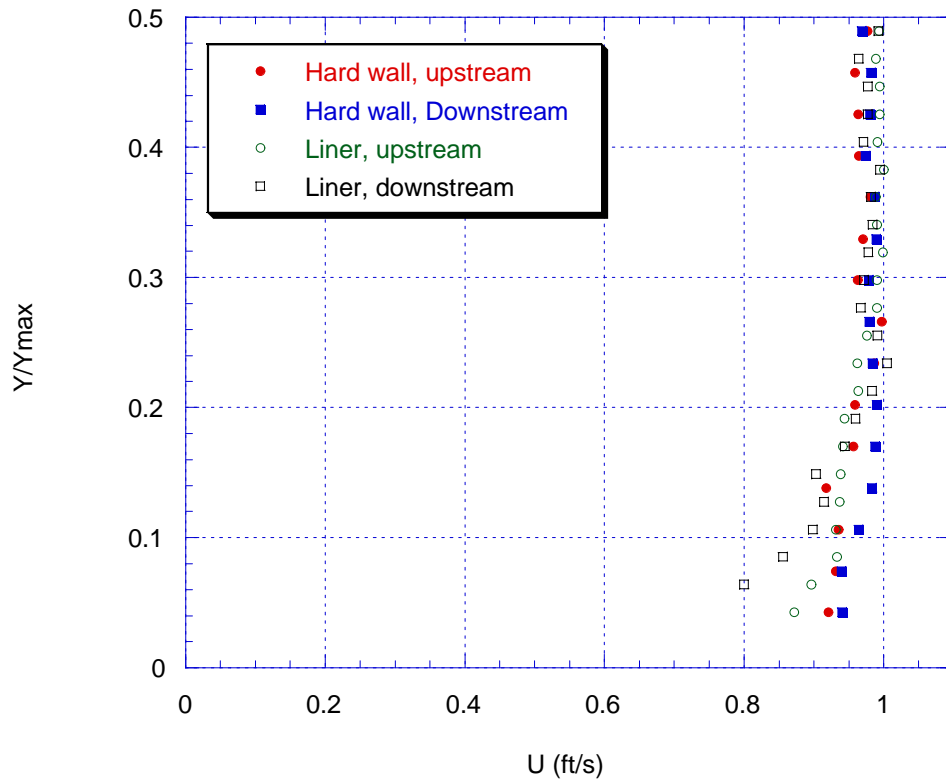

Figure 16. Velocity profiles for hard wall and lined wall cases for Mach number = 0.1.

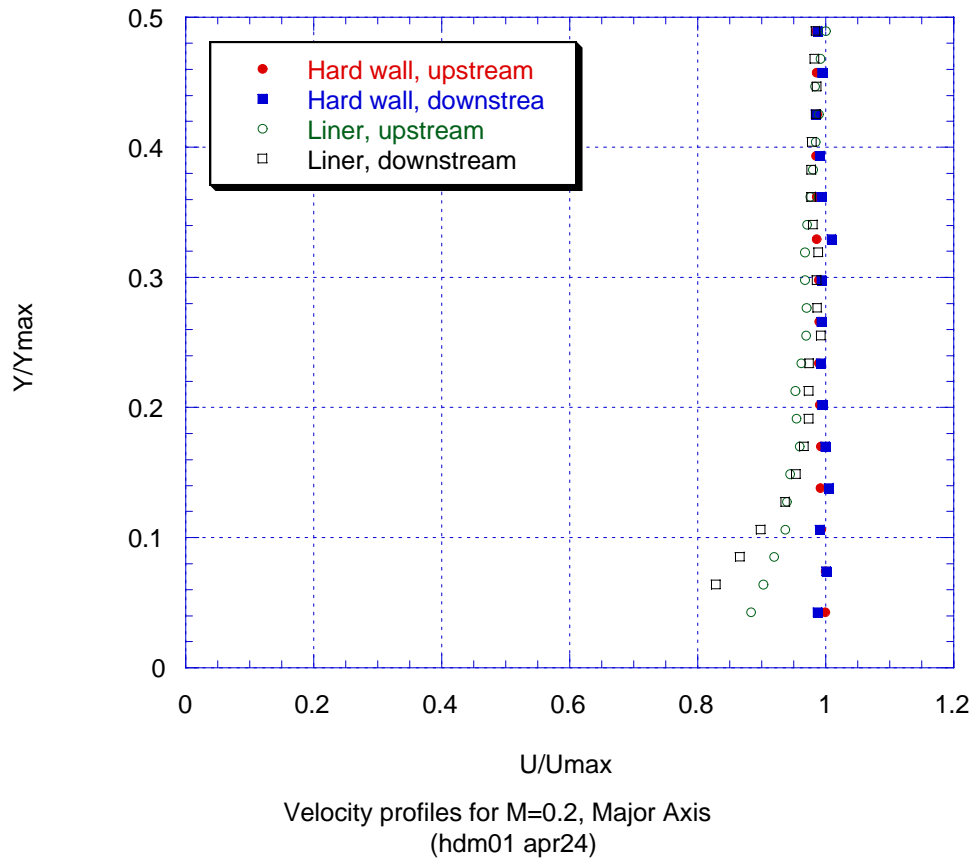

Figure 17. Velocity profiles for hard wall and lined wall cases for Mach number = 0.2.

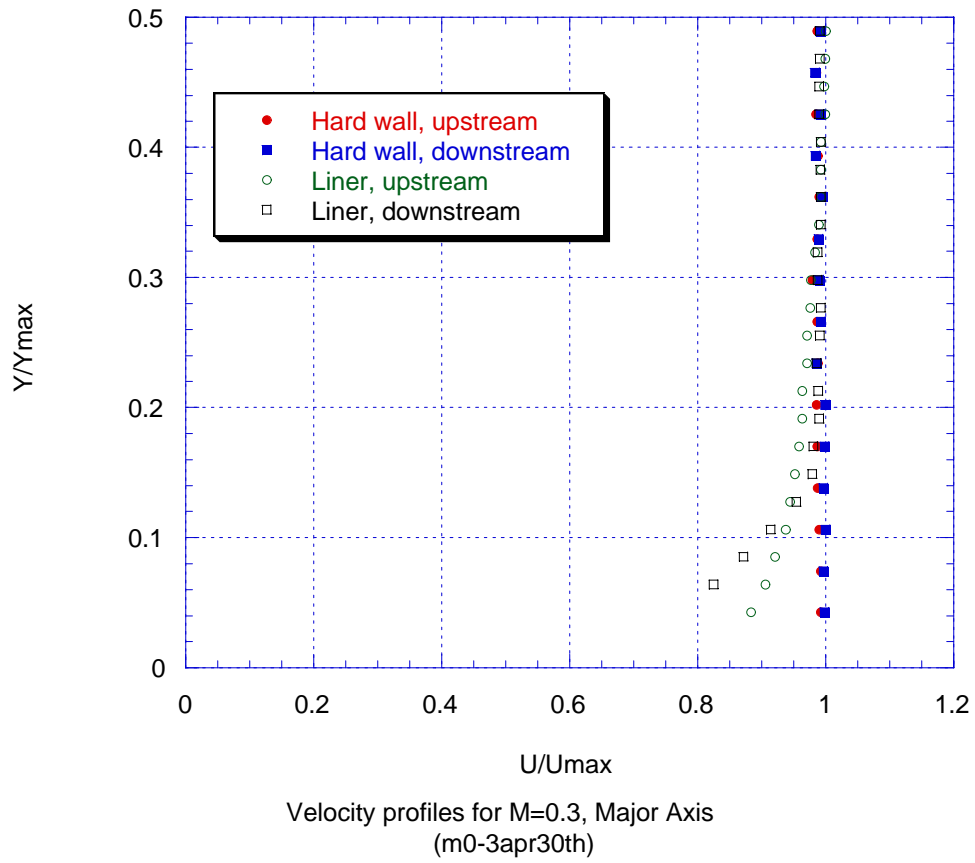
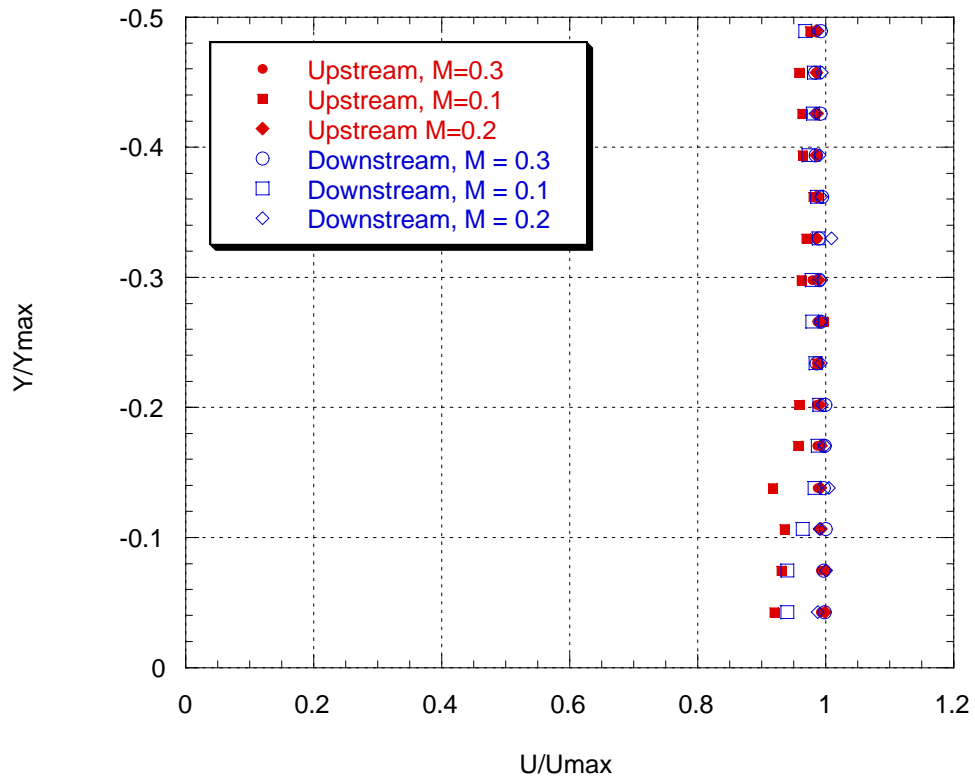
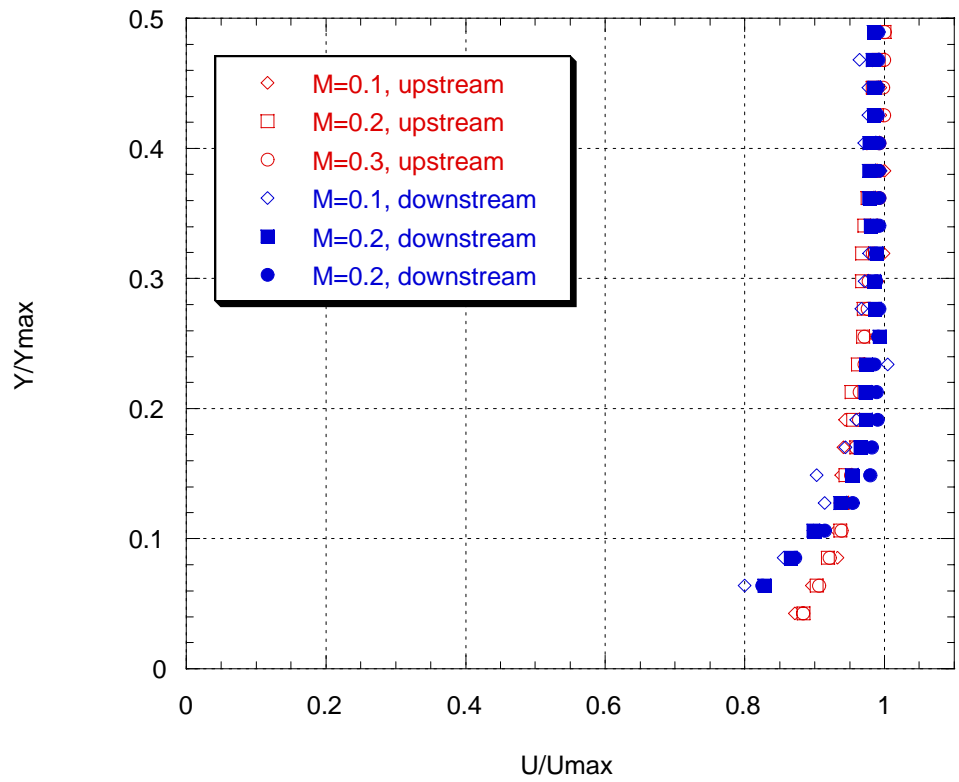

Figure 18. Velocity profiles for hard wall and lined wall cases for Mach number = 0.3.



Velocity profiles for $M = 0.1$, $M = 0.2$, $M = 0.3$ Hardwall, Major Axis

Figure 19. Velocity profiles across the major axis for various Mach numbers without liners installed (hard walls installed in liner housings).



Major axis, Liners installed 2 short walls,
 Upstream and Downstream planes velocity profiles
 (up1a, up2a, up3a, dn1, dn2, dn3, velocity profiles, 6/23)

Figure 20. Velocity profiles across the major axis for various Mach numbers with liner installed.

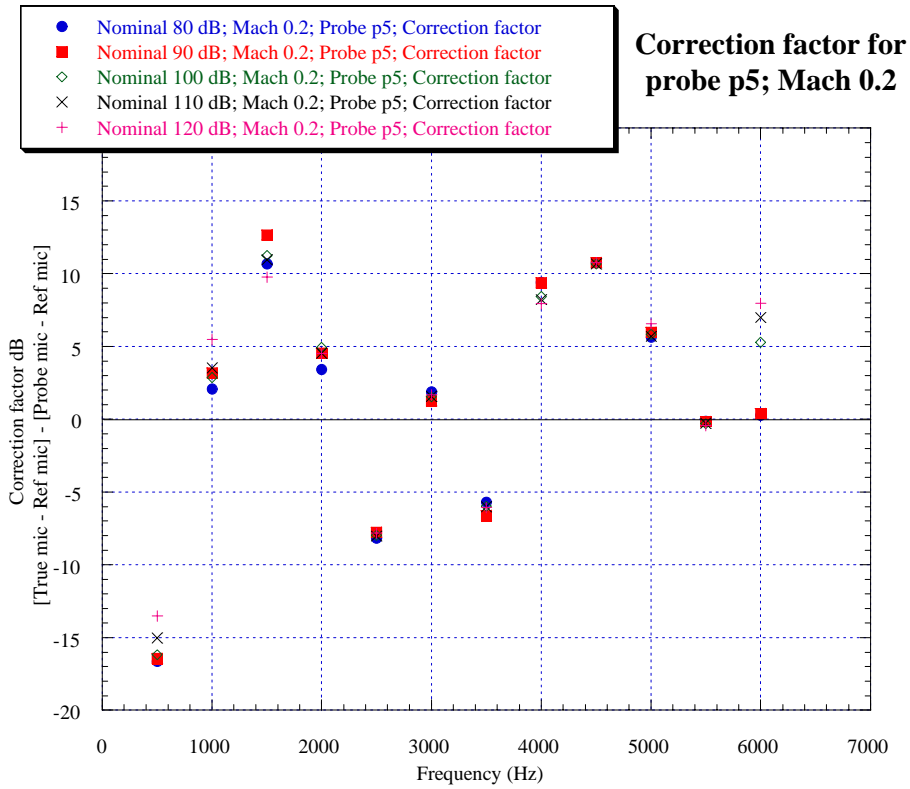

Figure Correction for probe p5; Mach 0.2; [True mic - Ref mic] - [Probe mic - Ref mic]
Nominal velocity +/- 5%; $\Delta f = 4$ Hz.

Figure 21. Calibration correction for probe p5, typical calibration result

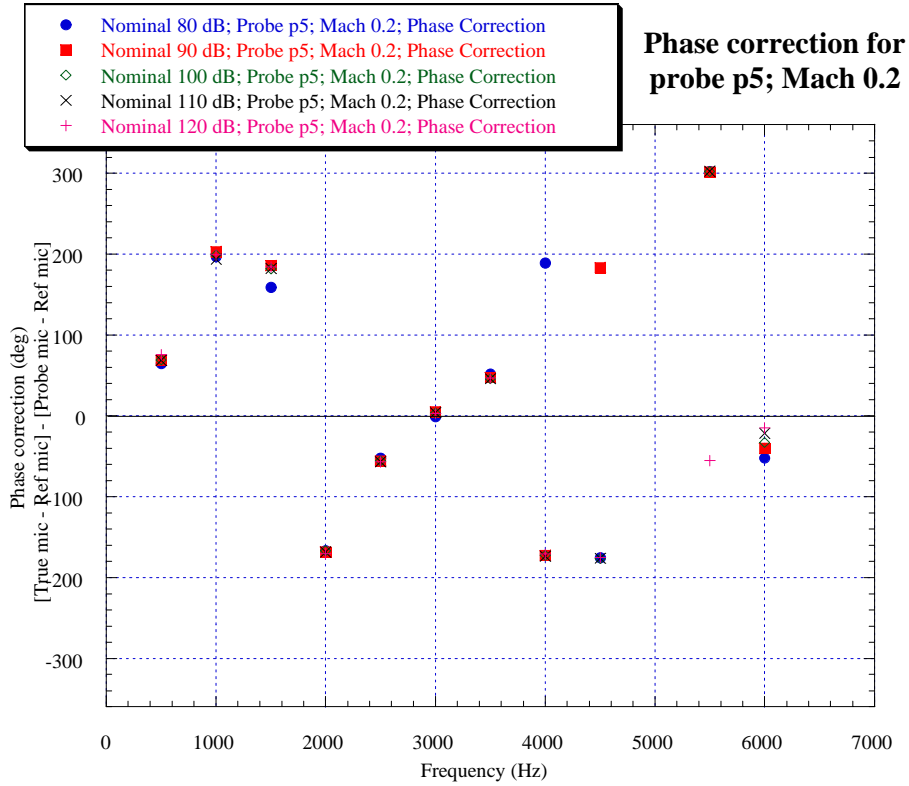
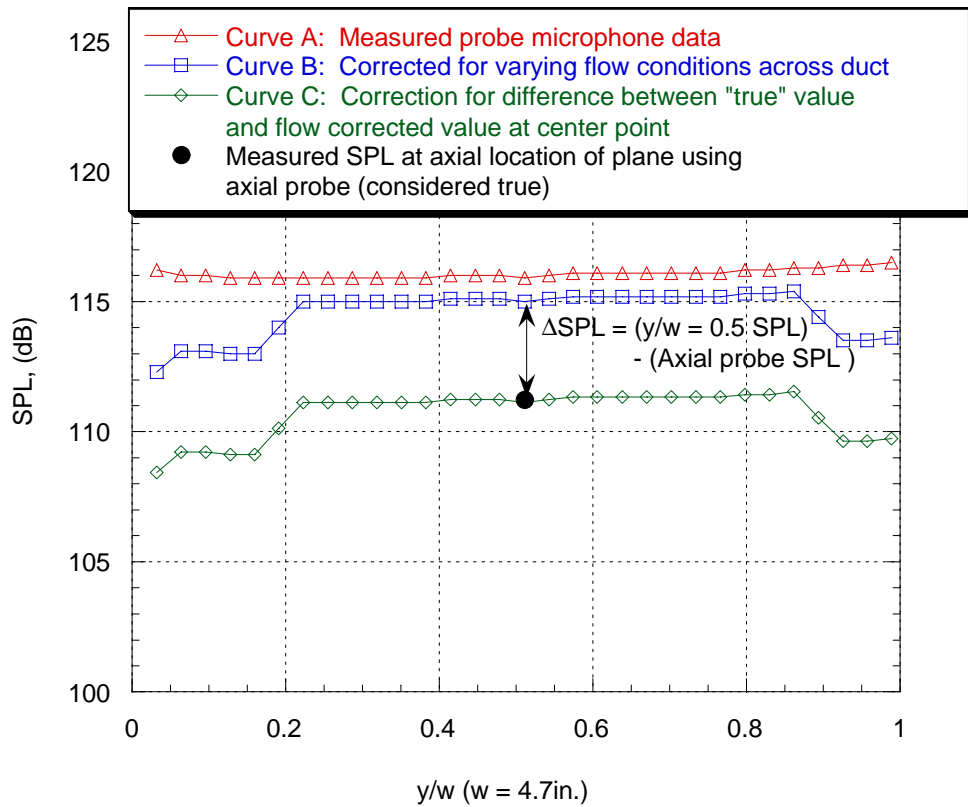

Figure Phase correction for probe p5; Mach 0.2; [True mic - Ref mic] - [Probe mic - Ref mic]
Nominal velocity +/- 5%; $\Delta f = 4$ Hz.

Figure 22. Phase calibration correction for probe p5, typical calibration result.



Sample SPL distribution across major axis to demonstrate calibration procedure (SAMPLE, not actual data)

Figure 23. Sample plot demonstrating SPL correction procedure.

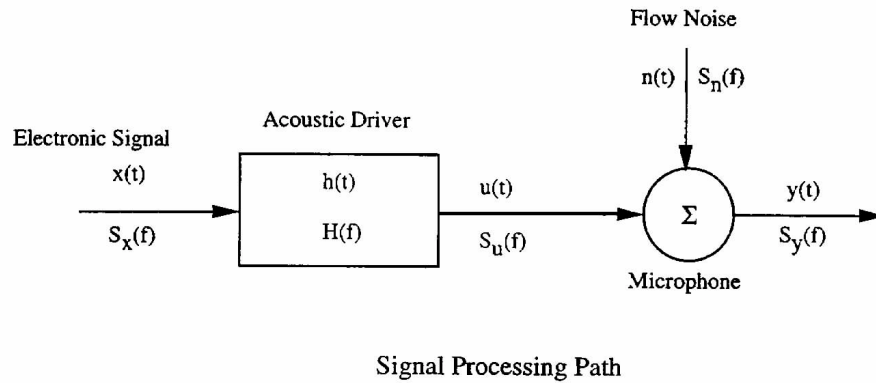

Nomenclature:

$x(t)$ is the electronic signal fed to the acoustic driver via an amplifier

$h(t)$ is the transfer function of the acoustic driver

$n(t)$ is the flow noise measured by the microphone

$y(t)$ is the output of the microphone which includes $u(t)$ and $n(t)$, i.e., $y(t)=u(t) + n(t)$

$S_x(f)$, $H(f)$, $S_u(f)$, $S_n(f)$, and $S_y(f)$ are the corresponding frequency domain quantities

G_{yx} is the cross spectrum between y and x

G_{xx} , G_{yy} , G_{uu} , and G_{nn} are the autospectra corresponding to $x(t)$, $y(t)$, $u(t)$, and $n(t)$ respectively

Figure 24. Schematic of signal processing path.

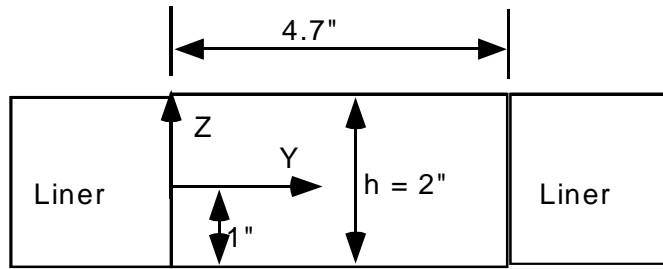

(Looking Upstream)

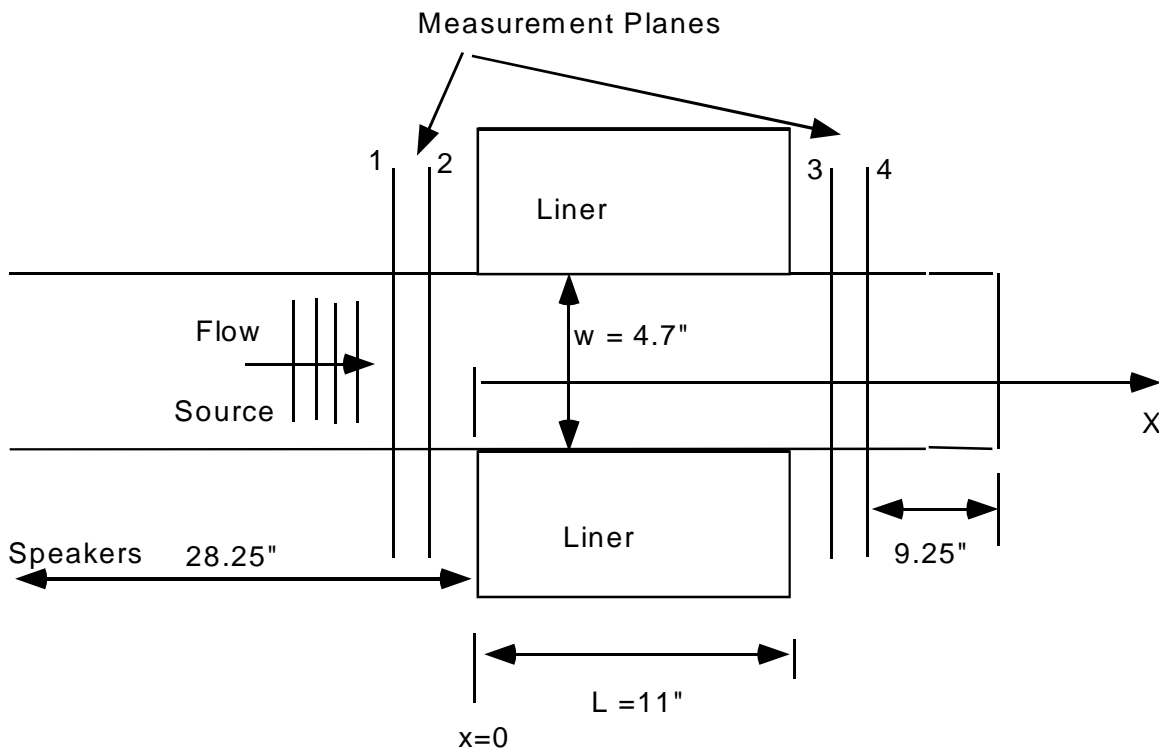

(Top View)

All location data is non-dimensionalized by the appropriate dimension
 $x/L = x/11"$ (liner section length)
 $y/w = y/4.7"$ (width)
 $z/h = z/2"$ (height)

Figure 25. Measurement locations schematic.

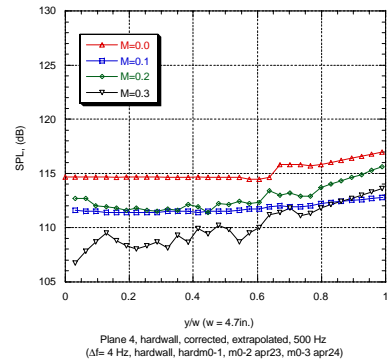
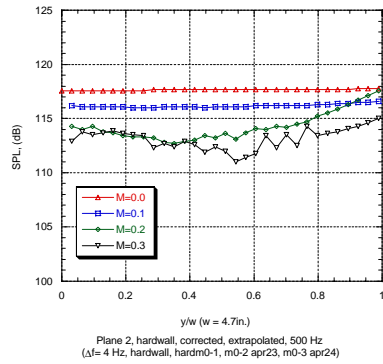
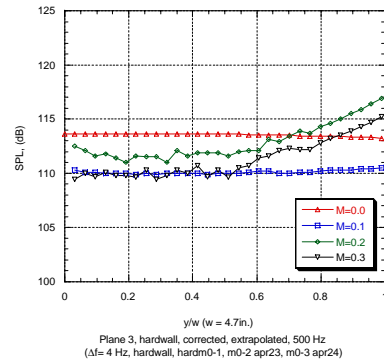
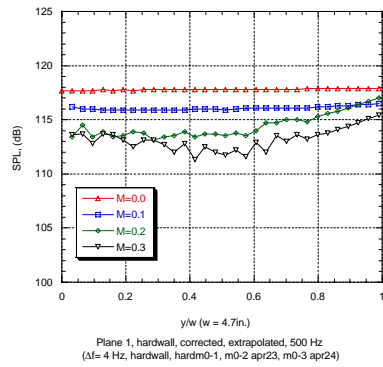
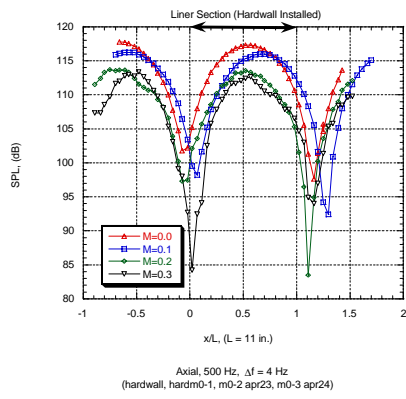

Figure 26. SPL data for 500 Hz hard wall case.

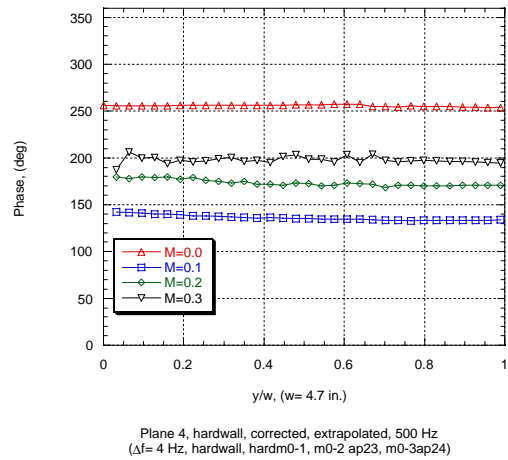
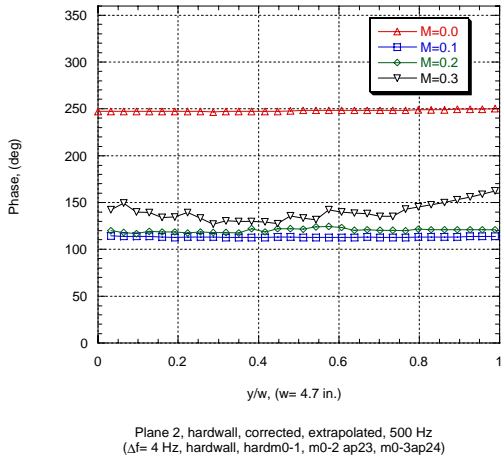
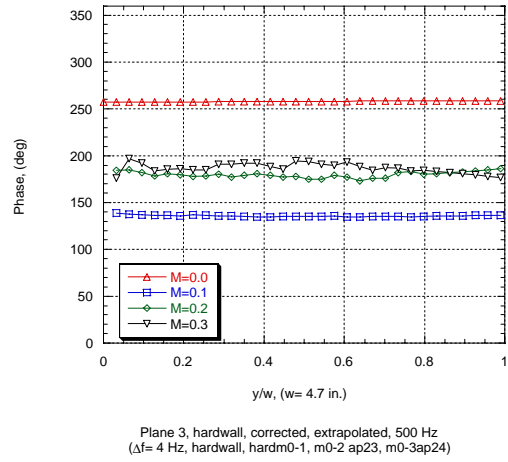
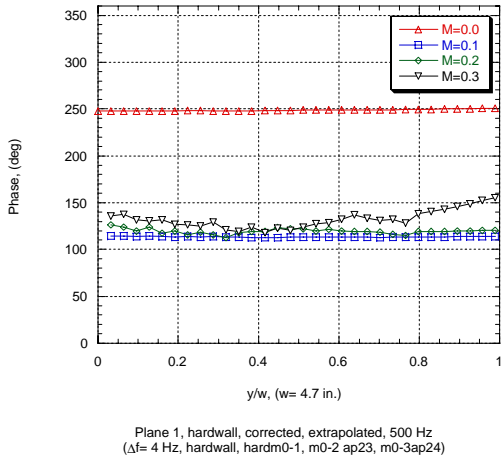
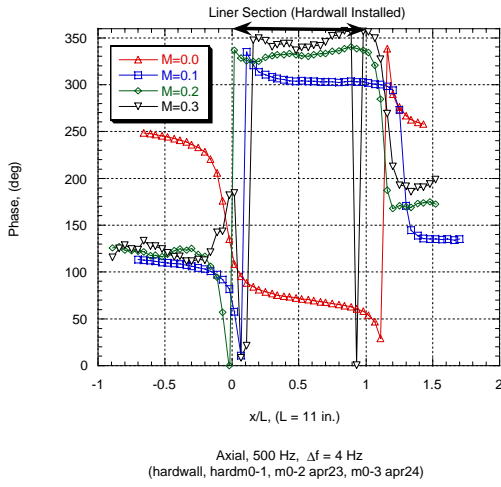

Figure 27. Phase data for 500 Hz hard wall case.

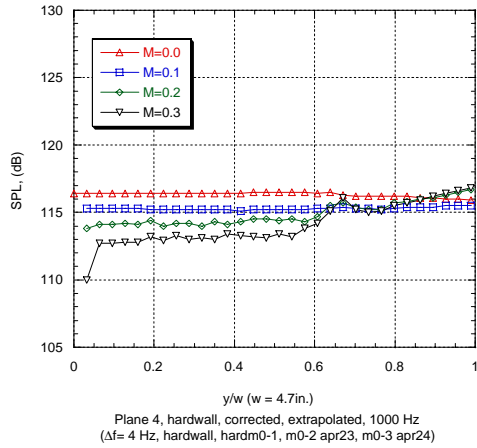
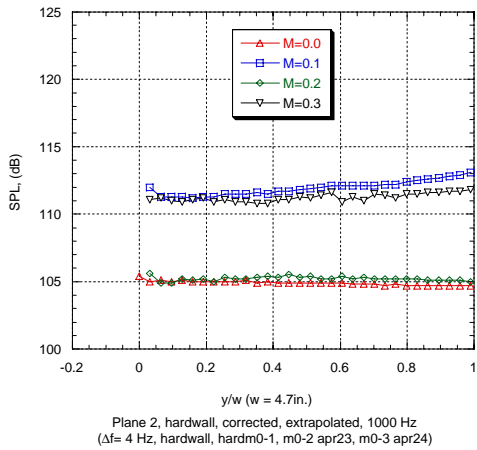
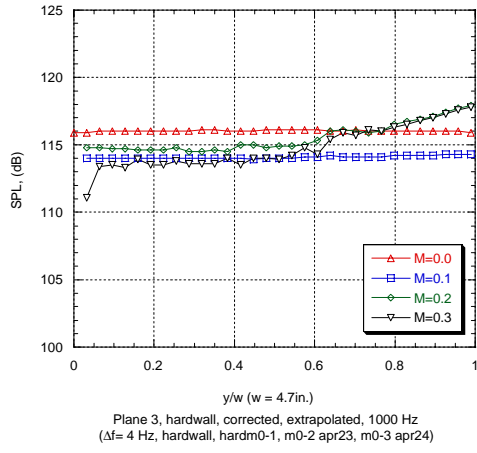
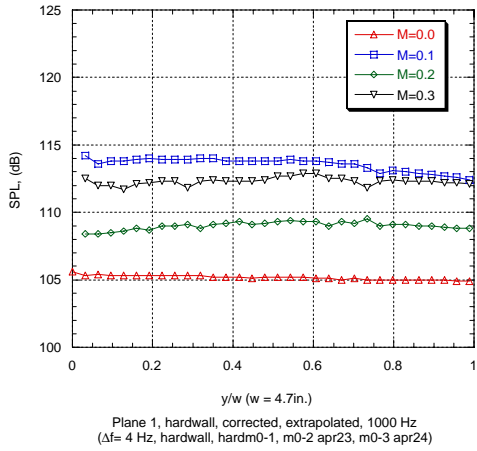
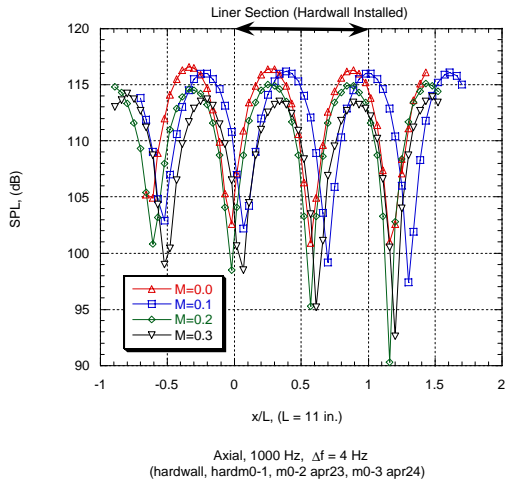

Figure 28. SPL data for 1000 Hz hard wall case.

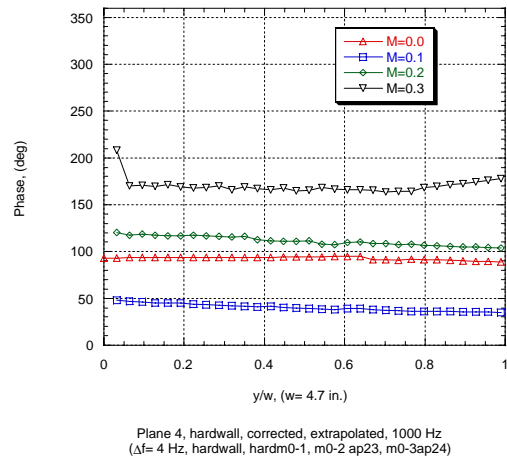
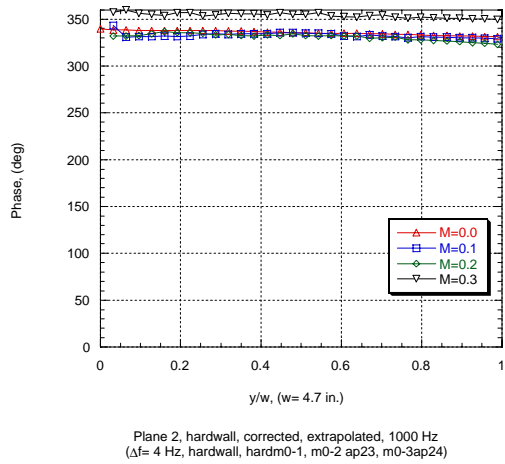
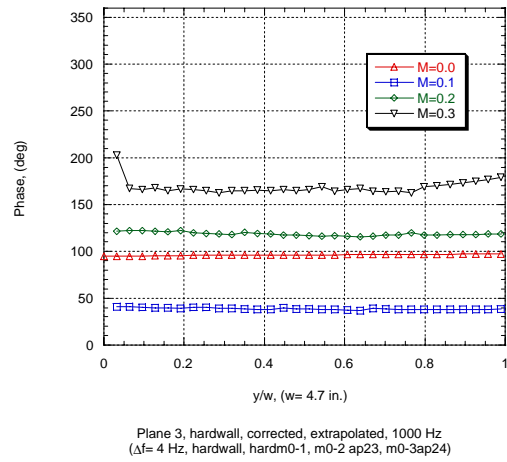
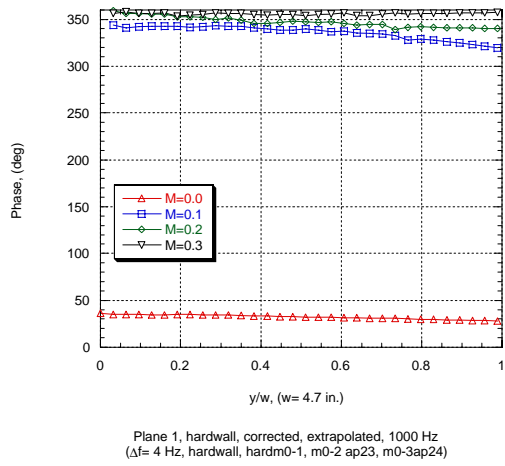
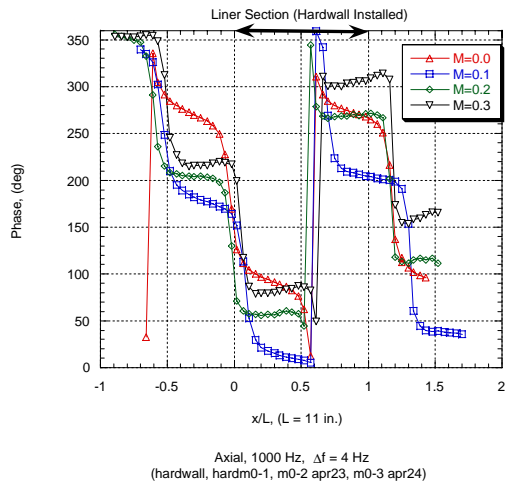

Figure 29. Phase data for 1000 Hz hard wall case.

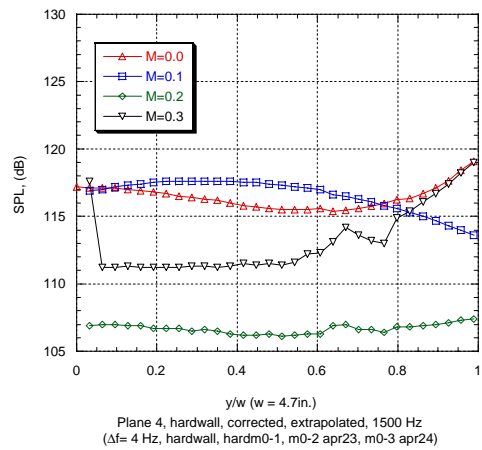
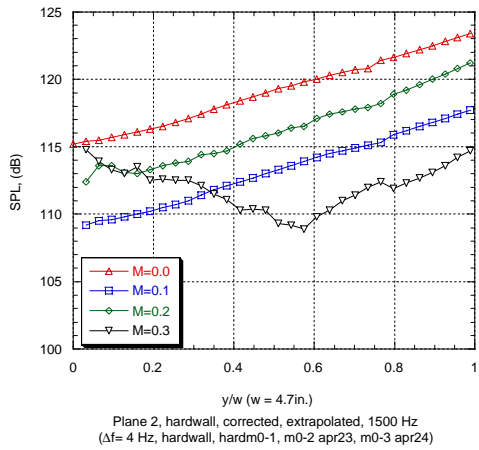
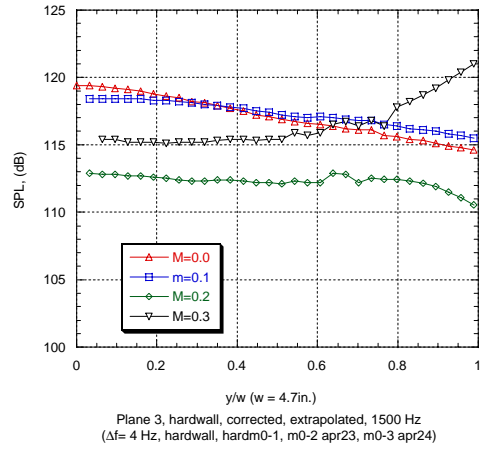
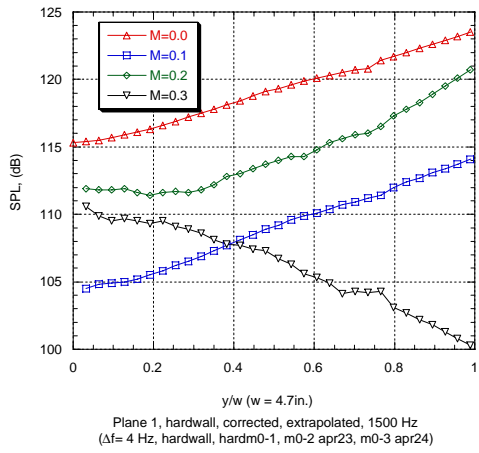
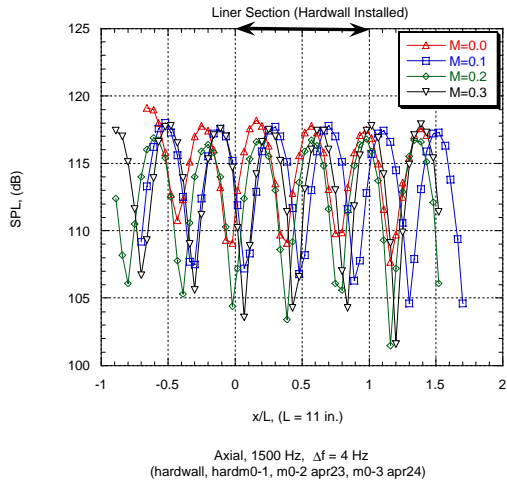

Figure 30. SPL data for 1500 Hz hard wall case.

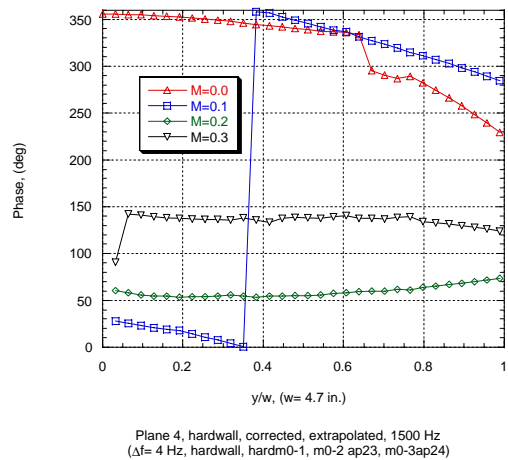
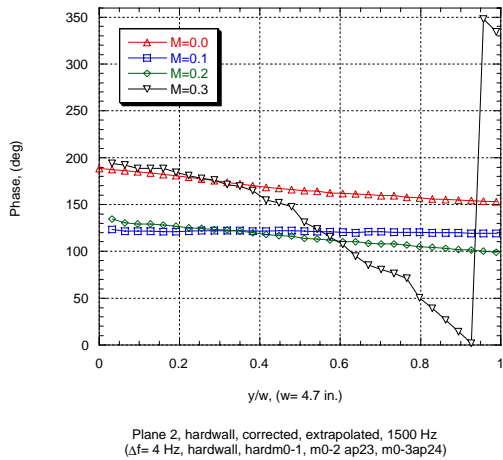
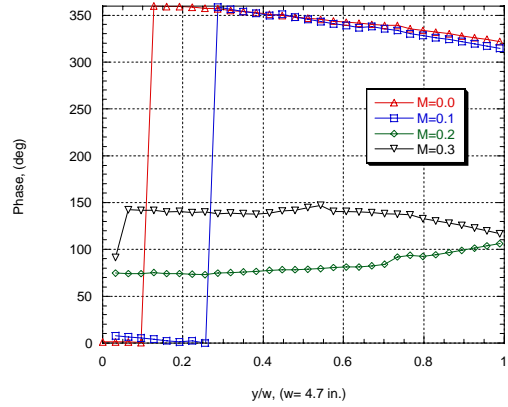
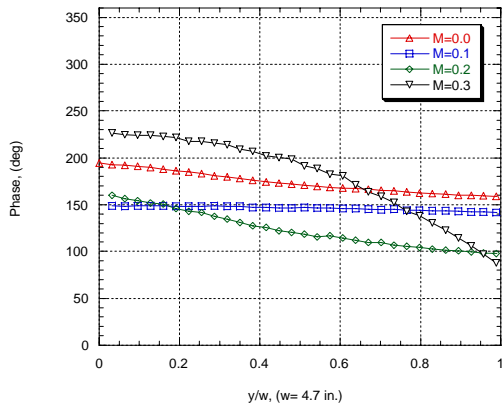
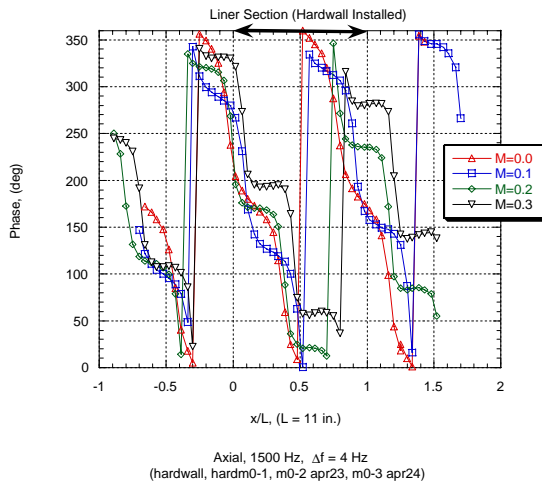

Figure 31. Phase data for 1500 Hz hard wall case.

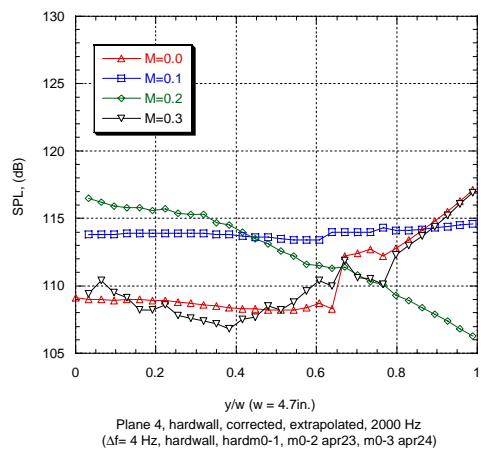
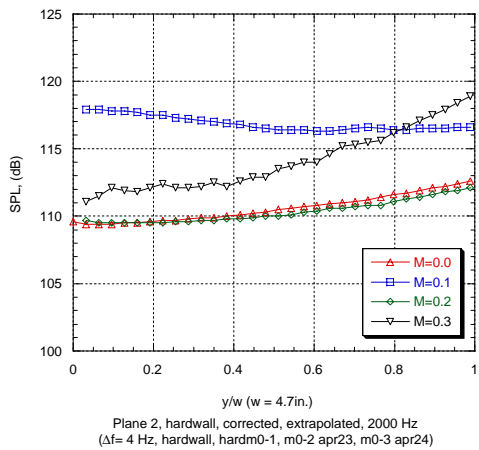
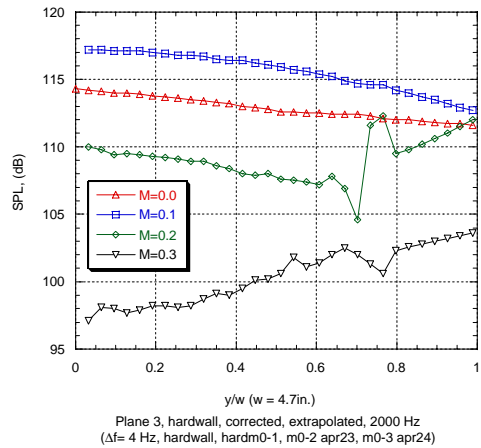
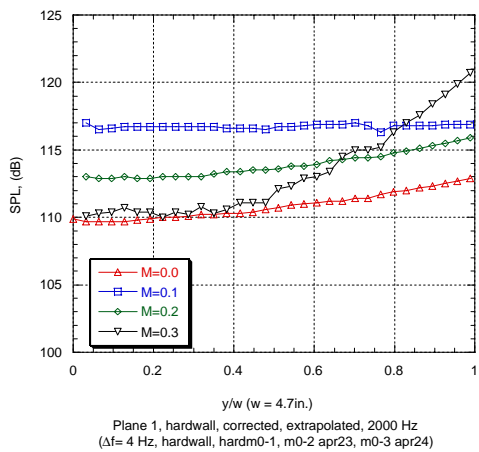
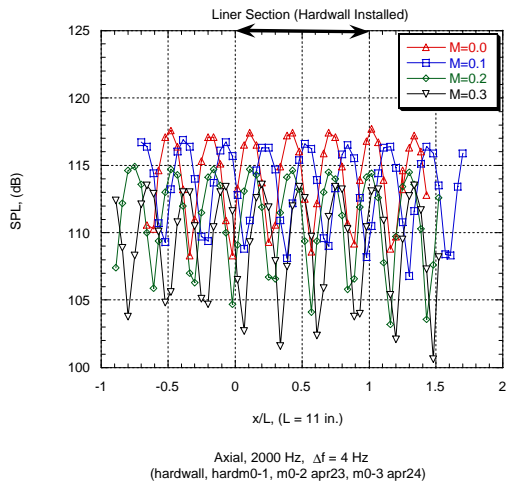

Figure 32. SPL data for 2000 Hz hard wall case.

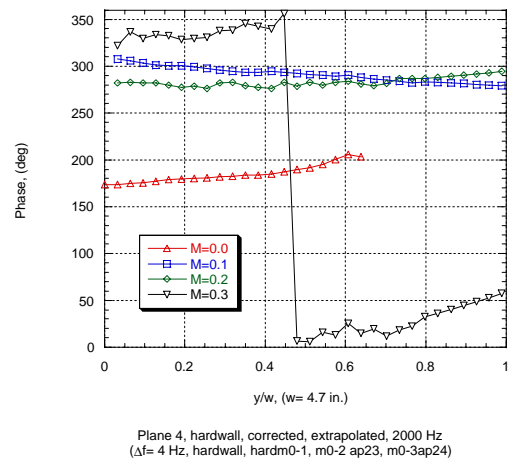
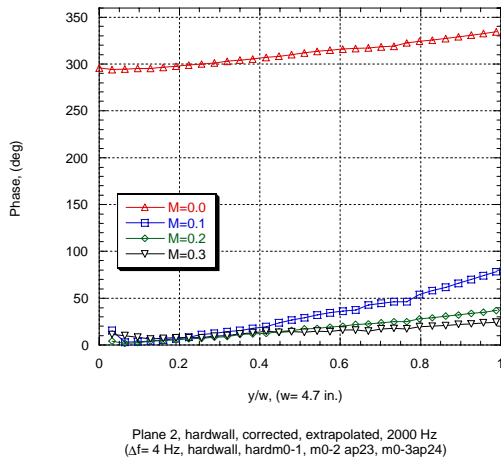
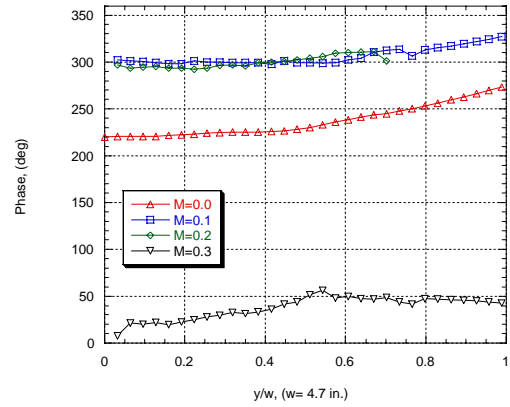
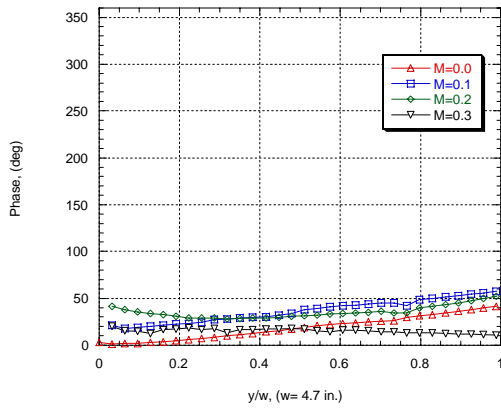
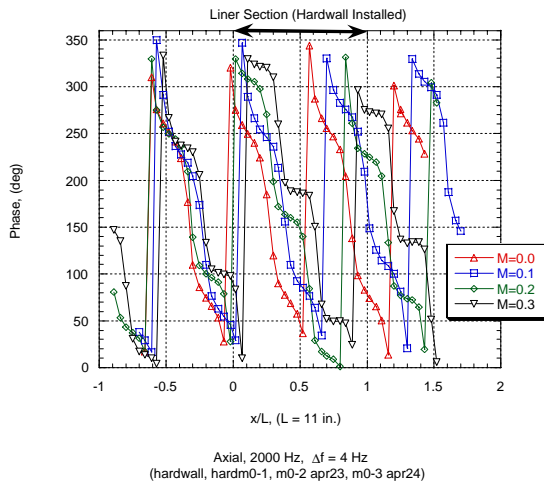

Figure 33. Phase data for 2000 Hz hard wall case.

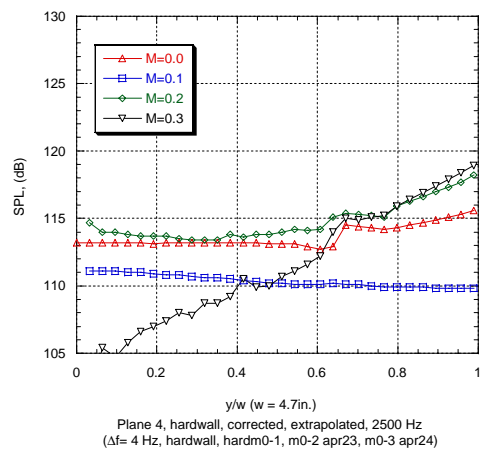
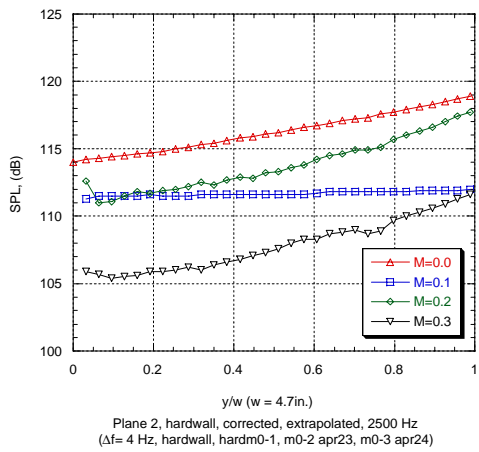
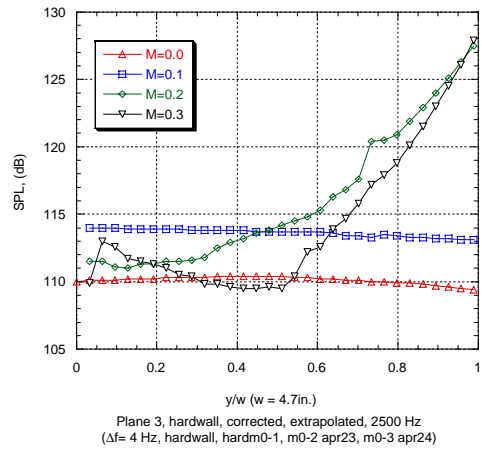
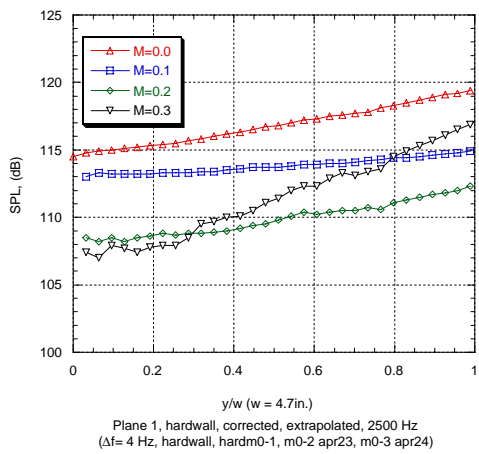
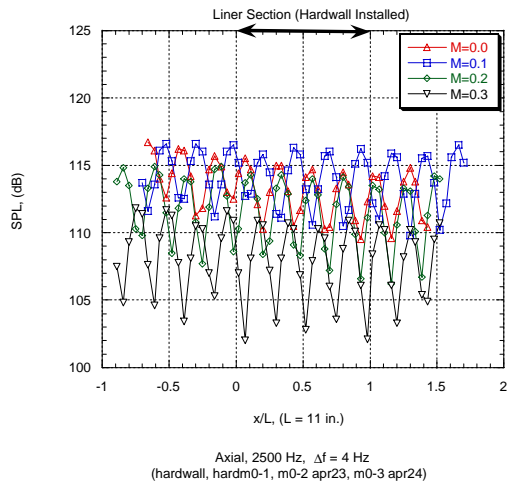

Figure 34. SPL data for 2500 Hz hard wall case.

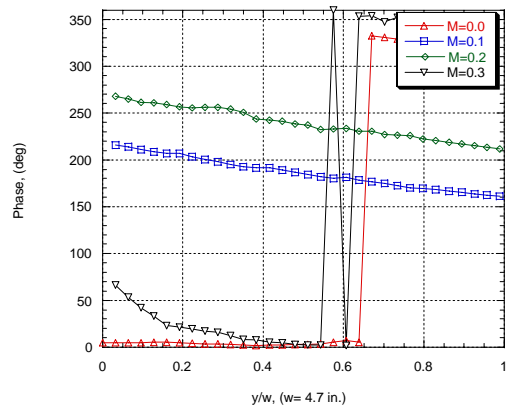
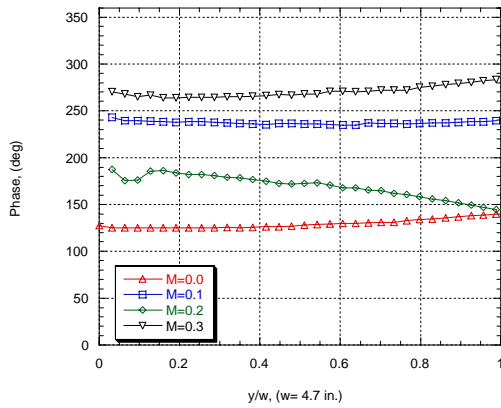
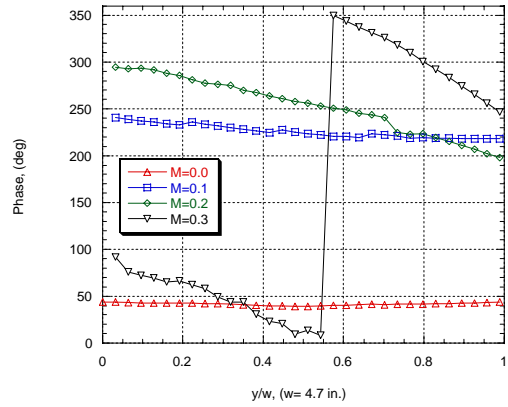
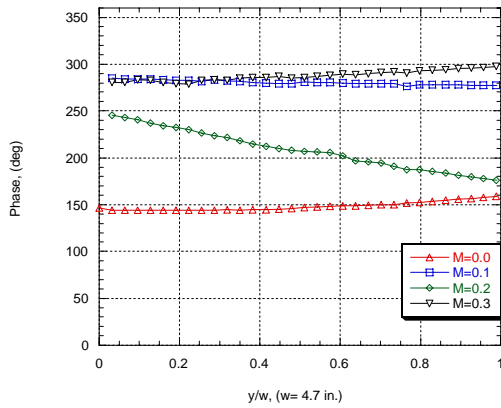
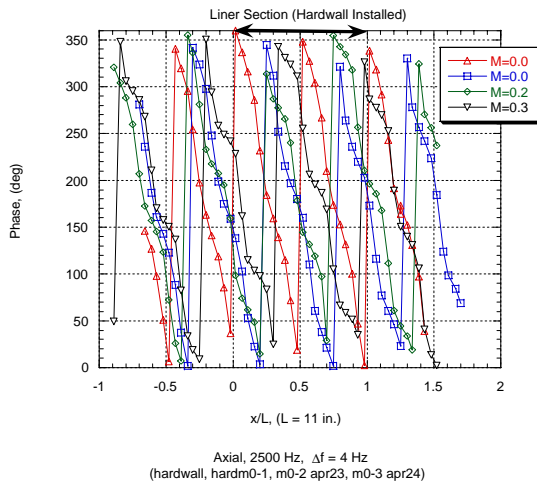
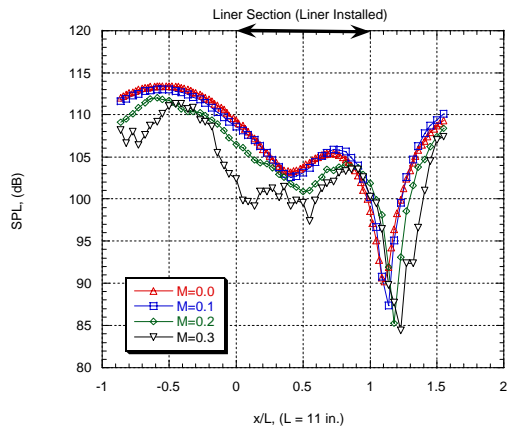
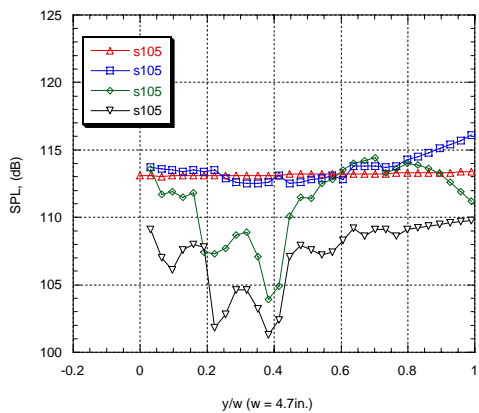

Figure 35. Phase data for 2500 Hz hard wall case.



Axial, 500 Hz, $\Delta f = 4$ Hz
(linm0-0 May 27, linm0-1 May 29, linm0-2 Jun 25, linm0-3 June 25)



Plane 1, corrected, extrapolated, 500 Hz
($\Delta f = 4$ Hz, Linm0-0 May 27 Linm0-1 May 29, Linm0-2 June 25, Linm0-3 June 25)

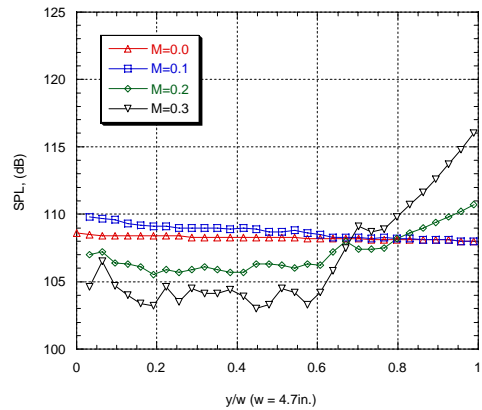

Plane 3, corrected, extrapolated, 500 Hz
($\Delta f = 4$ Hz, Linm0-0 May 27 Linm0-1 May 29, Linm0-2 June 25, Linm0-3 June 25)

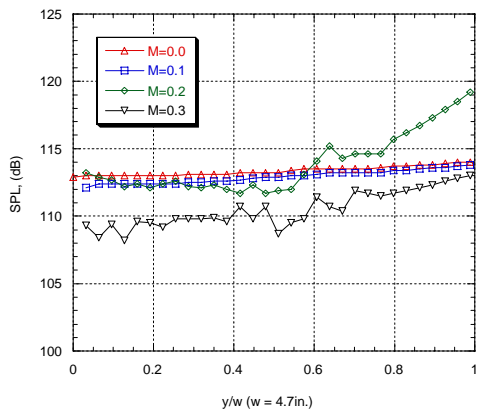

Plane 2, corrected, extrapolated, 500 Hz
($\Delta f = 4$ Hz, Linm0-0 May 27 Linm0-1 May 29, Linm0-2 June 25, Linm0-3 June 25)

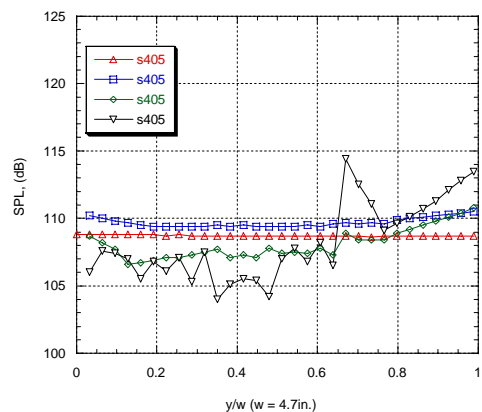

Plane 4, corrected, extrapolated, 500 Hz
($\Delta f = 4$ Hz, Linm0-0 May 27 Linm0-1 May 29, Linm0-2 June 25, Linm0-3 June 25)

Figure 36. SPL data for 500 Hz lined wall case.

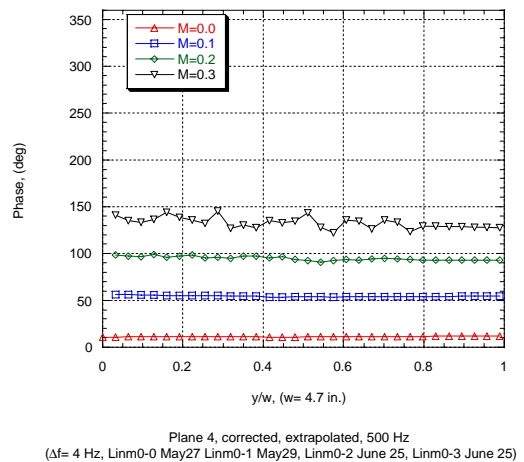
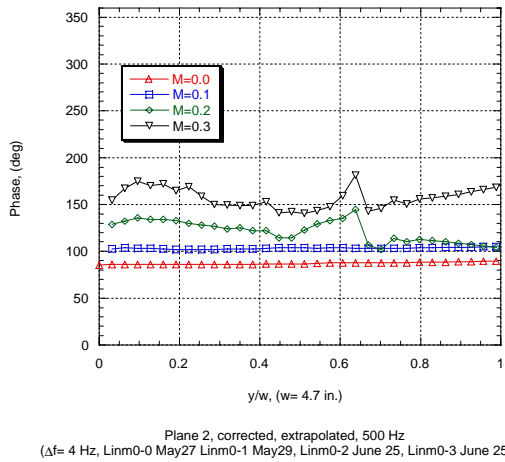
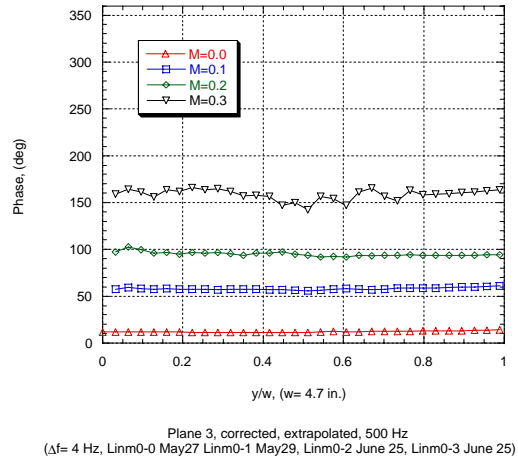
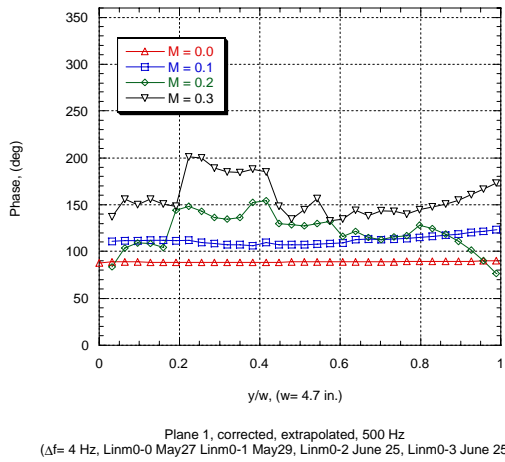
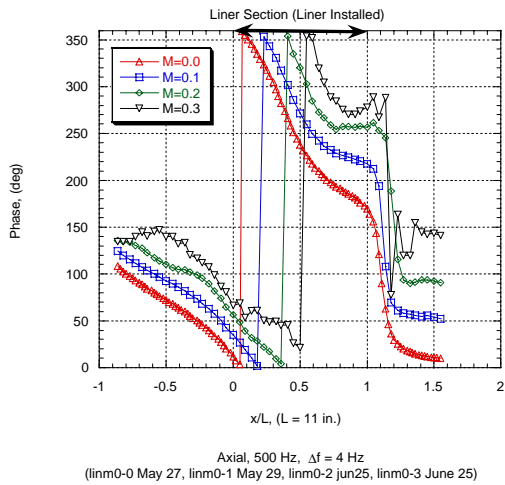
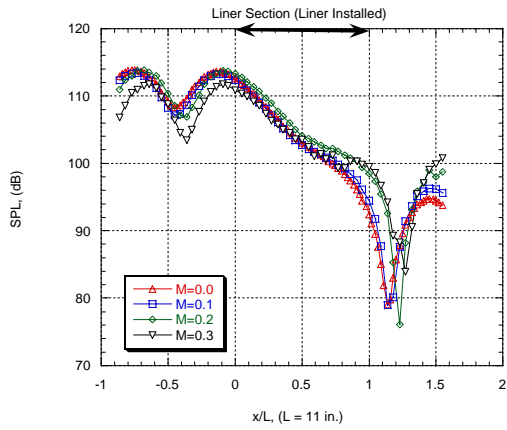
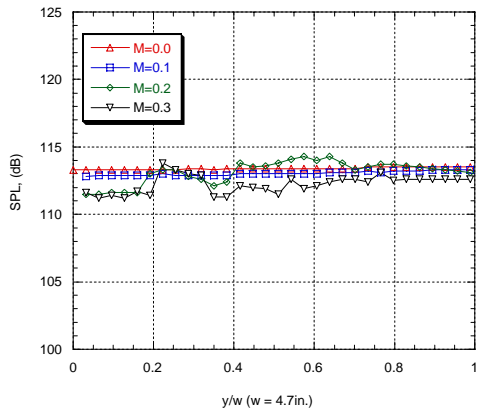

Figure 37. Phase data for 500 Hz lined wall case.



Axial, 1000 Hz, $\Delta f = 4$ Hz
(linm0-0 May 27, linm0-1 May 29, linm0-2 Jun 25, linm0-3 June 25)



Plane 1, corrected, extrapolated, 1000 Hz
($\Delta f = 4$ Hz, Linm0-0 May 27 Linm0-1 May 29, Linm0-2 June 25, Linm0-3 June 25)

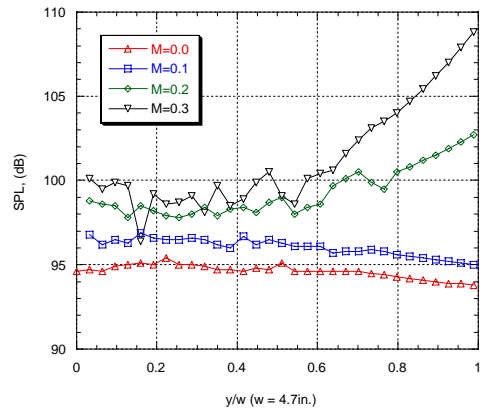

Plane 3, corrected, extrapolated, 1000 Hz
($\Delta f = 4$ Hz, Linm0-0 May 27 Linm0-1 May 29, Linm0-2 June 25, Linm0-3 June 25)

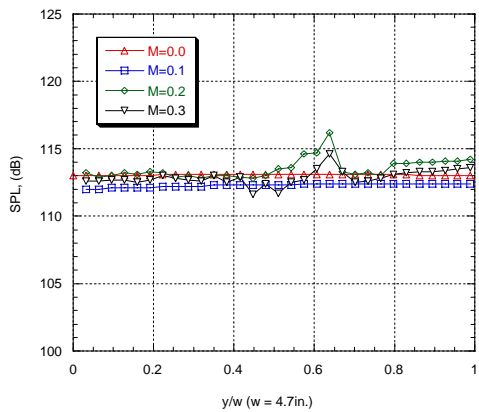

Plane 2, corrected, extrapolated, 1000 Hz
($\Delta f = 4$ Hz, Linm0-0 May 27 Linm0-1 May 29, Linm0-2 June 25, Linm0-3 June 25)

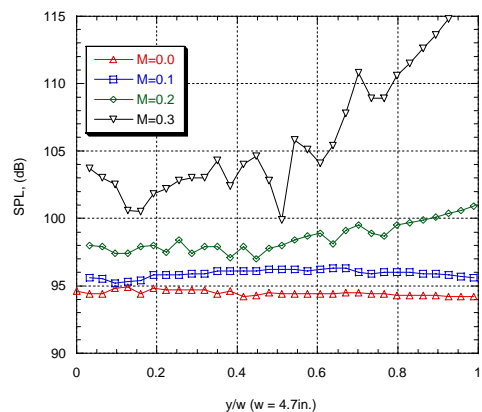

Plane 4, corrected, extrapolated, 1000 Hz
($\Delta f = 4$ Hz, Linm0-0 May 27 Linm0-1 May 29, Linm0-2 June 25, Linm0-3 June 25)

Figure 38. SPL data for 1000 Hz lined wall case.

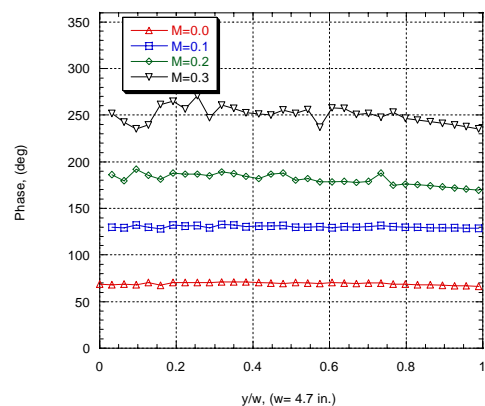
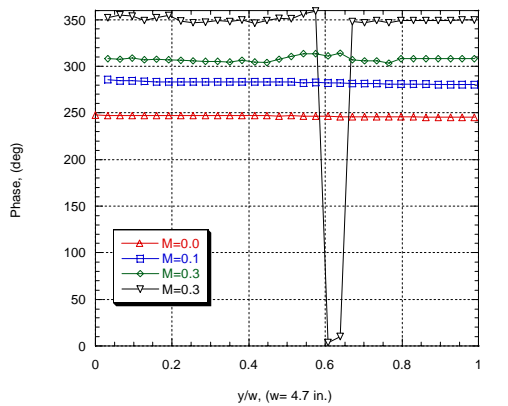
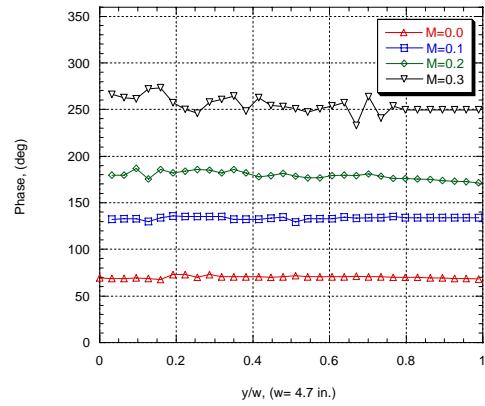
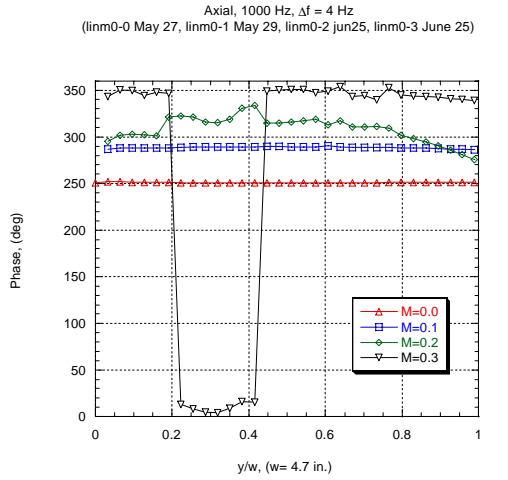
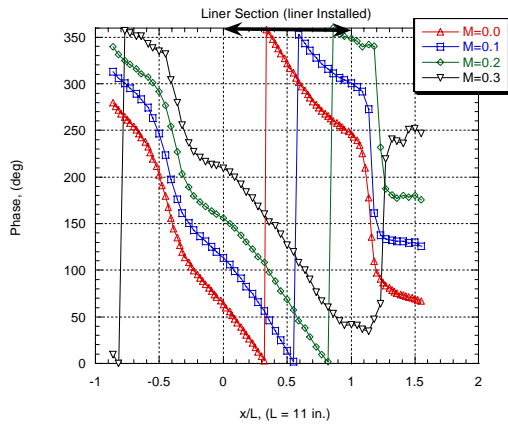
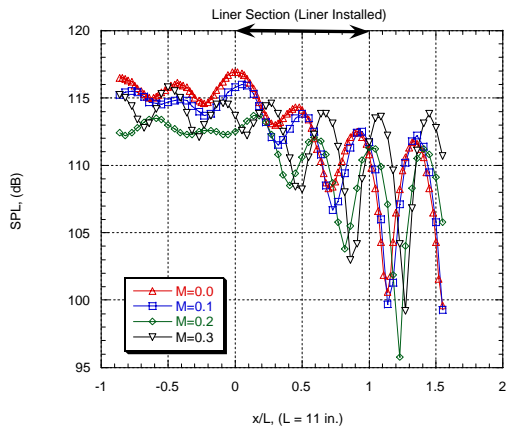
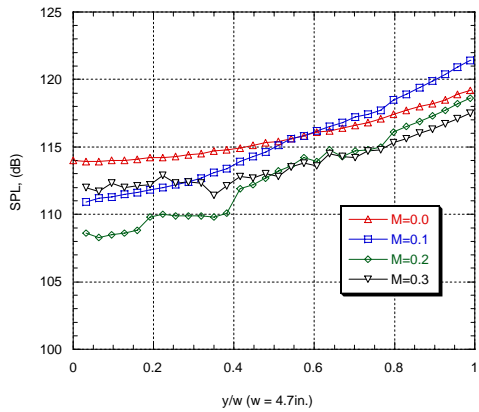

Figure 39. SPL data for 1000 Hz lined wall case.



Axial, 1500 Hz, $\Delta f = 4$ Hz
(linm0-0 May 27, linm0-1 May 29, linm0-2 Jun 25, linm0-3 June 25)



Plane 1, corrected, extrapolated, 1500 Hz
($\Delta f = 4$ Hz, Linm0-0 May 27, Linm0-1 May 29, Linm0-2 June 25, Linm0-3 June 25)

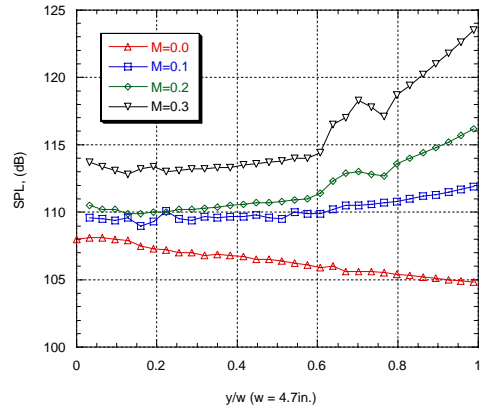

Plane 3, corrected, extrapolated, 1500 Hz
($\Delta f = 4$ Hz, Linm0-0 May 27, Linm0-1 May 29, Linm0-2 June 25, Linm0-3 June 25)

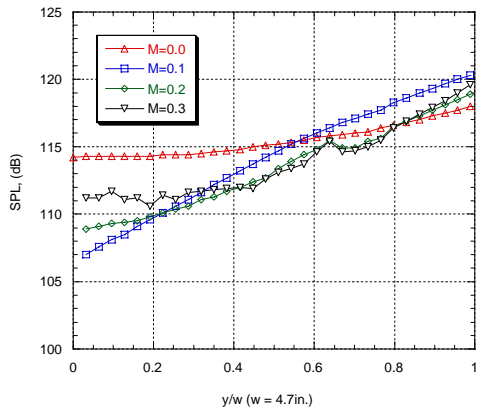

Plane 2, corrected, extrapolated, 1500 Hz
($\Delta f = 4$ Hz, Linm0-0 May 27, Linm0-1 May 29, Linm0-2 June 25, Linm0-3 June 25)

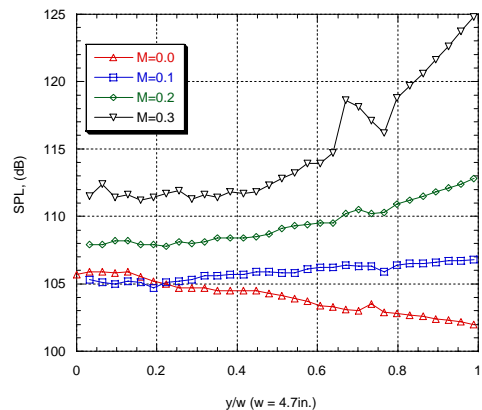

Plane 4, corrected, extrapolated, 1500 Hz
($\Delta f = 4$ Hz, Linm0-0 May 27, Linm0-1 May 29, Linm0-2 June 25, Linm0-3 June 25)

Figure 40. SPL data for 1500 Hz lined wall case.

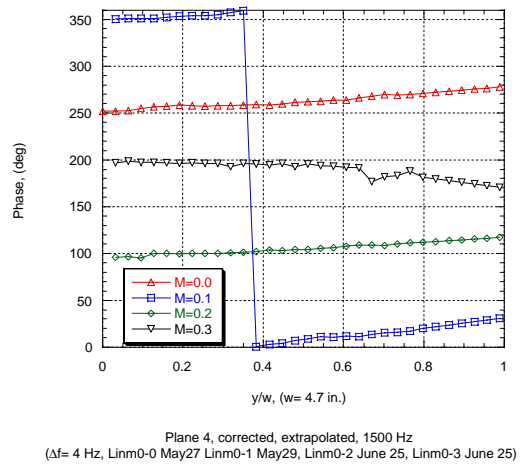
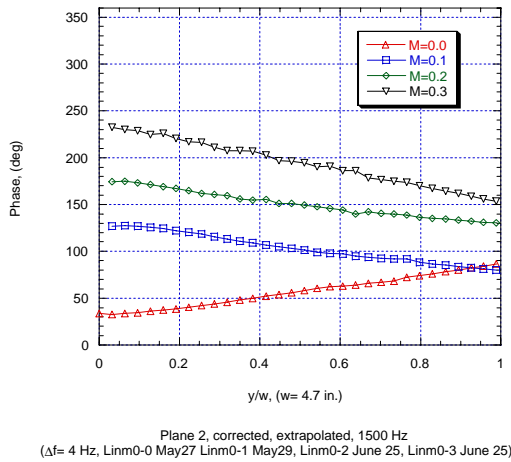
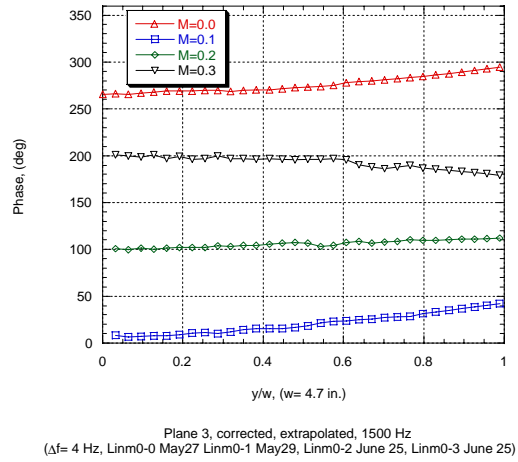
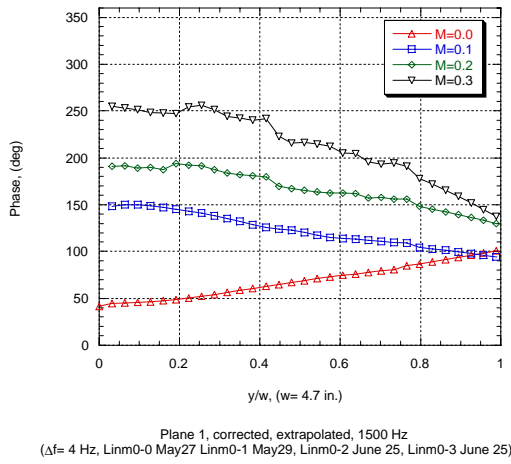
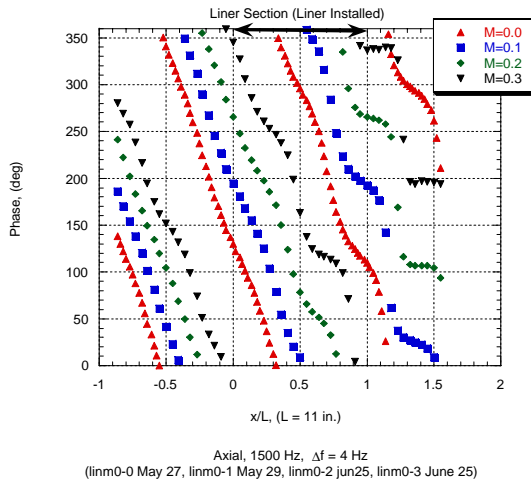
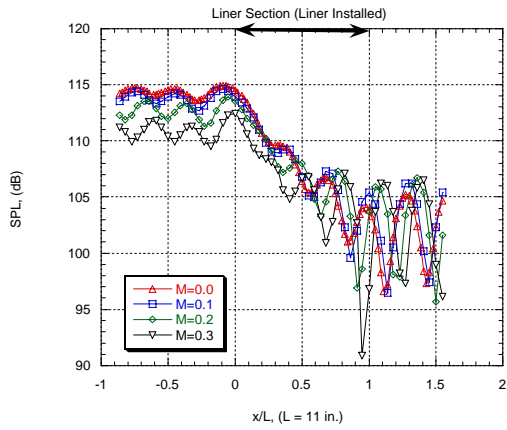
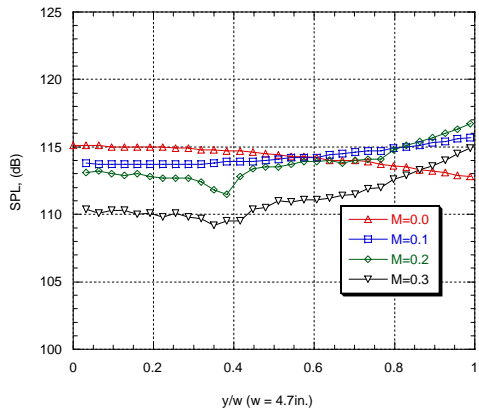

Figure 41. Phase data for 1500 Hz lined wall case.



Axial, 2000 Hz, $\Delta f = 4$ Hz
(linm0-0 May 27, linm0-1 May 29, linm0-2 Jun 25, linm0-3 June 25)



Plane 1, corrected, extrapolated, 2000 Hz
($\Delta f = 4$ Hz, Linm0-0 May 27 Linm0-1 May 29, Linm0-2 June 25, Linm0-3 June 25)

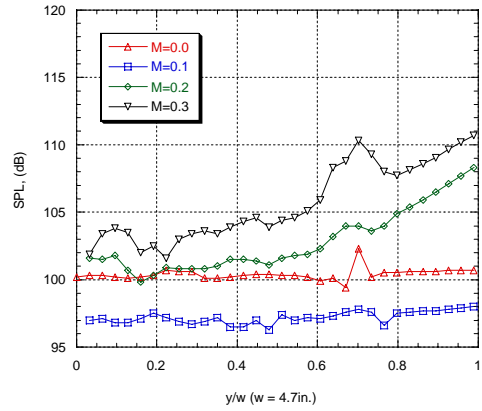

Plane 3, corrected, extrapolated, 2000 Hz
($\Delta f = 4$ Hz, Linm0-0 May 27 Linm0-1 May 29, Linm0-2 June 25, Linm0-3 June 25)

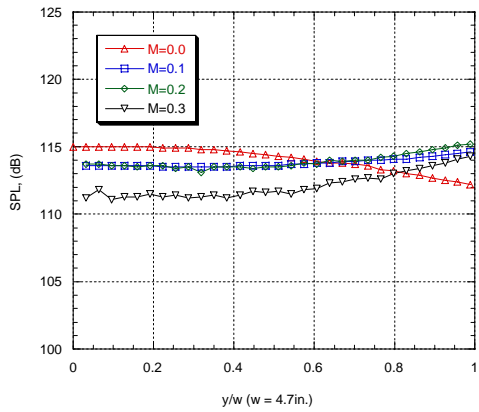

Plane 2, corrected, extrapolated, 2000 Hz
($\Delta f = 4$ Hz, Linm0-0 May 27 Linm0-1 May 29, Linm0-2 June 25, Linm0-3 June 25)

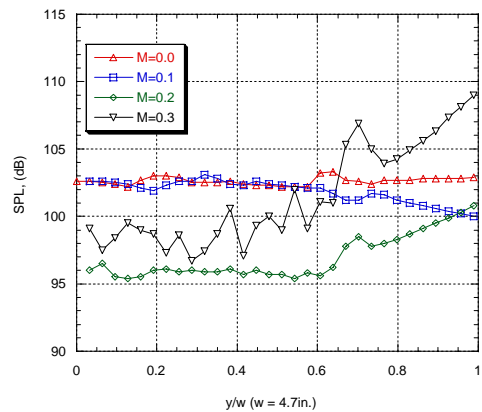

Plane 4, corrected, extrapolated, 2000 Hz
($\Delta f = 4$ Hz, Linm0-0 May 27 Linm0-1 May 29, Linm0-2 June 25, Linm0-3 June 25)

Figure 42. SPL data for 2000 Hz lined wall case.

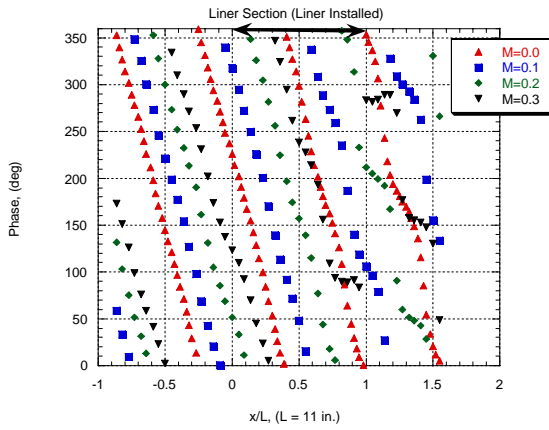

Axial, 2000 Hz, $\Delta f = 4$ Hz
 (linm0-0 May 27, linm0-1 May 29, linm0-2 Jun 25, linm0-3 June 25)

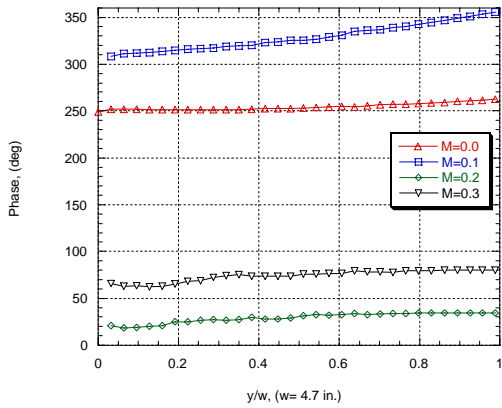

Plane 1, corrected, extrapolated, 2000 Hz
 ($\Delta f = 4$ Hz, Linm0-0 May 27 Linm0-1 May 29, Linm0-2 June 25, Linm0-3 June 25)

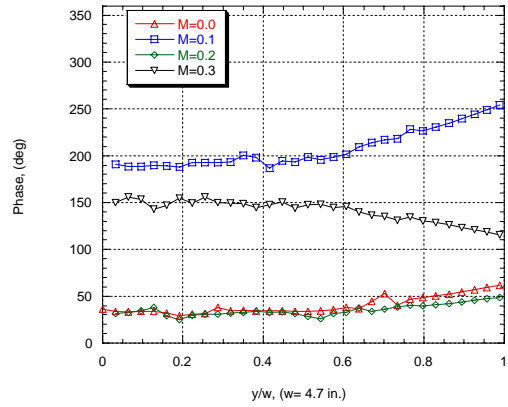

Plane 3, corrected, extrapolated, 2000 Hz
 ($\Delta f = 4$ Hz, Linm0-0 May 27 Linm0-1 May 29, Linm0-2 June 25, Linm0-3 June 25)

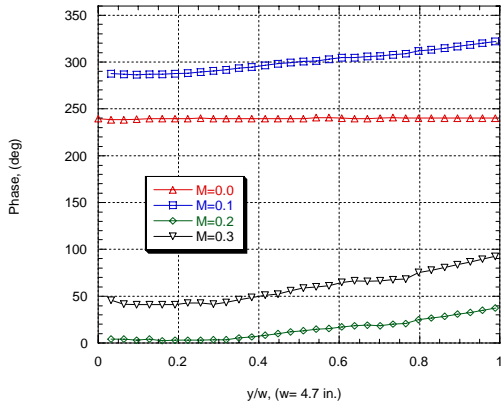

Plane 2, corrected, extrapolated, 2000 Hz
 ($\Delta f = 4$ Hz, Linm0-0 May 27 Linm0-1 May 29, Linm0-2 June 25, Linm0-3 June 25)

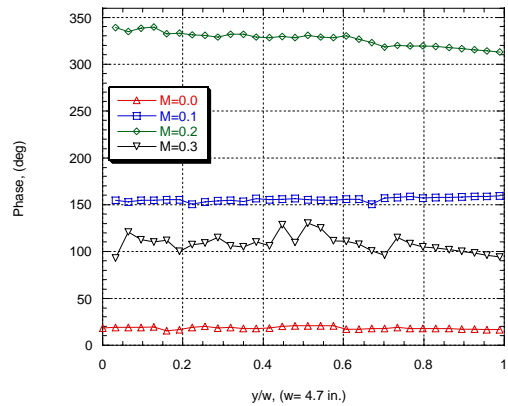

Plane 4, corrected, extrapolated, 2000 Hz
 ($\Delta f = 4$ Hz, Linm0-0 May 27 Linm0-1 May 29, Linm0-2 June 25, Linm0-3 June 25)

Figure 43. Phase data for 2000 Hz lined wall case.

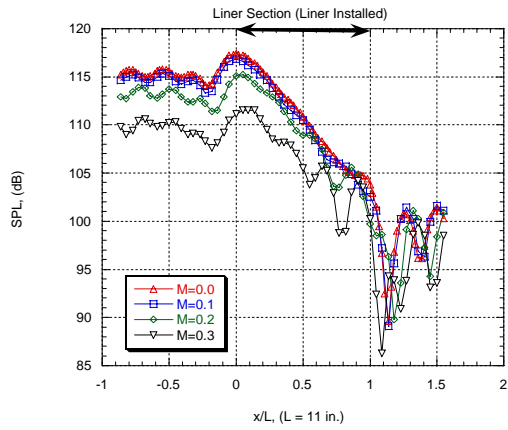

Axial, 2500 Hz, $\Delta f = 4$ Hz
(linm0-0 May 27, linm0-1 May 29, linm0-2 jun25, linm0-3 June 25)

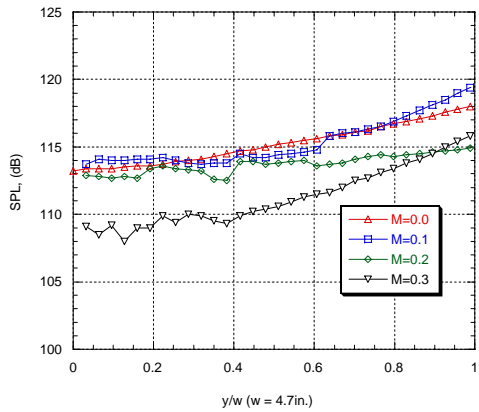

Plane 1, corrected, extrapolated, 2500 Hz
($\Delta f = 4$ Hz, Linm0-0 May27 Linm0-1 May29, Linm0-2 June 25, Linm0-3 June 25)

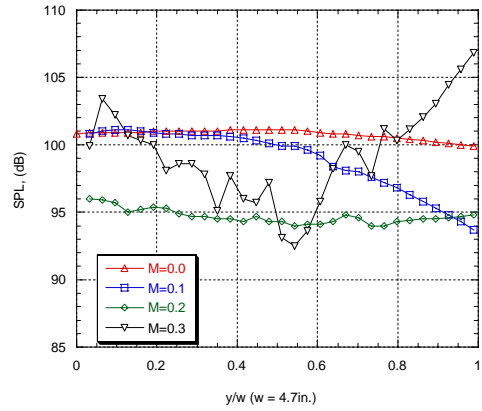

Plane 3, corrected, extrapolated, 2500 Hz
($\Delta f = 4$ Hz, Linm0-0 May27 Linm0-1 May29, Linm0-2 June 25, Linm0-3 June 25)

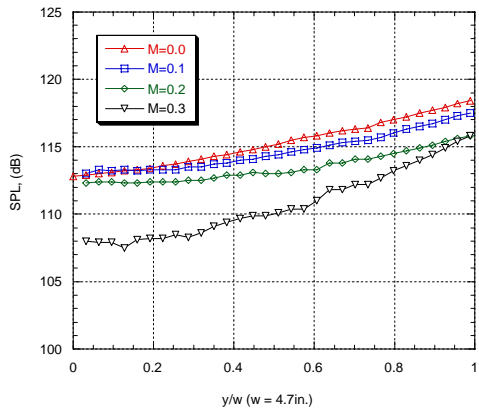

Plane 2, corrected, extrapolated, 2500 Hz
($\Delta f = 4$ Hz, Linm0-0 May27 Linm0-1 May29, Linm0-2 June 25, Linm0-3 June 25)

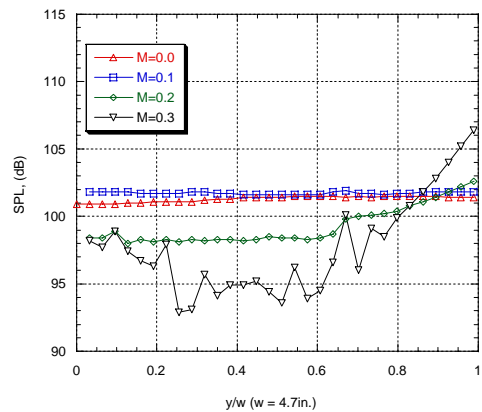

Plane 4, corrected, extrapolated, 2500 Hz
($\Delta f = 4$ Hz, Linm0-0 May27 Linm0-1 May29, Linm0-2 June 25, Linm0-3 June 25)

Figure 44. SPL data for 2500 Hz lined wall case.

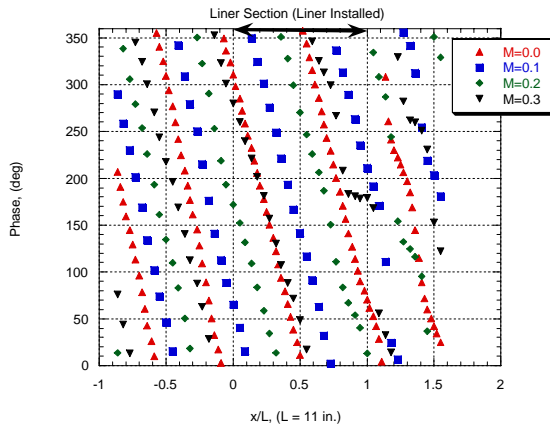

Axial, 2500 Hz, $\Delta f = 4$ Hz
 (linm0-0 May 27, linm0-1 May 29, linm0-2 Jun 25, linm0-3 June 25)

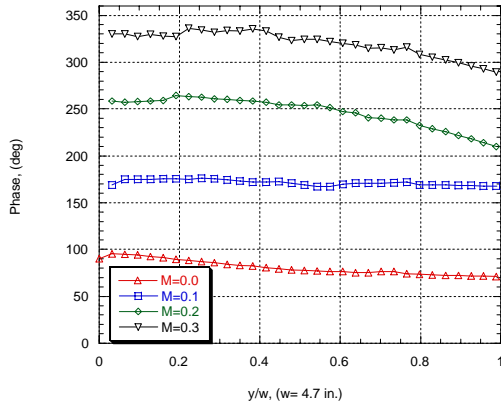

Plane 1, corrected, extrapolated, 2500 Hz
 ($\Delta f = 4$ Hz, Linm0-0 May 27 Linm0-1 May 29, Linm0-2 June 25, Linm0-3 June 25)

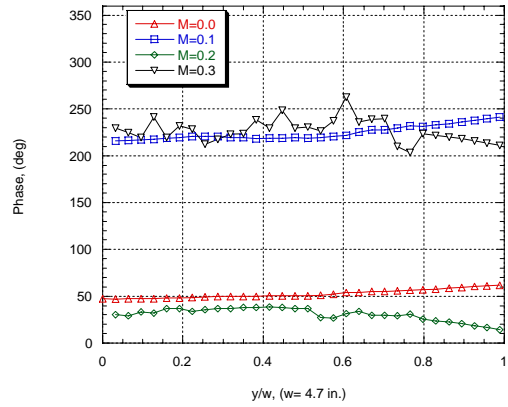

Plane 3, corrected, extrapolated, 2500 Hz
 ($\Delta f = 4$ Hz, Linm0-0 May 27 Linm0-1 May 29, Linm0-2 June 25, Linm0-3 June 25)

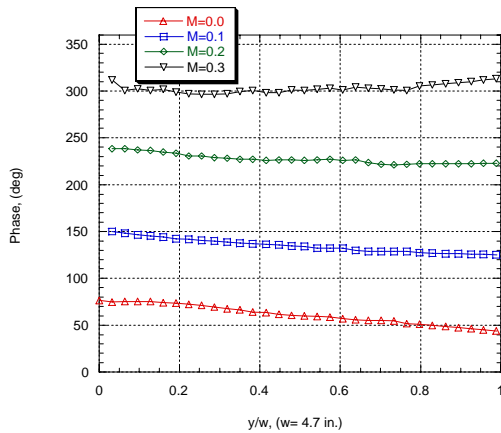

Plane 2, corrected, extrapolated, 2500 Hz
 ($\Delta f = 4$ Hz, Linm0-0 May 27 Linm0-1 May 29, Linm0-2 June 25, Linm0-3 June 25)

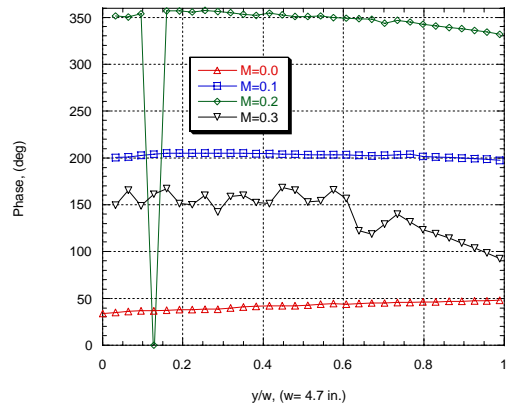

Plane 4, corrected, extrapolated, 2500 Hz
 ($\Delta f = 4$ Hz, Linm0-0 May 27 Linm0-1 May 29, Linm0-2 June 25, Linm0-3 June 25)

Figure 45. Phase data for 2500 Hz lined wall case.

Appendix

Listing of Acoustic and Flow Data Acquired

General Information:

Source Plane data = Planes 1 and 2

Exit Plane data = Planes 3 and 4

Plane locations (w. r. t. streamwise location of liner x = 0.0)

plane 1: -7.75 in.

Plane 3: +16.0

Planes 2 and 4 are 0.3 in. behind planes 1 and 3, respectively.

L = 11.0 in.

w = 4.7 in.

h = 2.0 in.

Hard wall

M=0.0

T = 47 F

500 Hz

source plane data

y/w	z/h	spl phase	spl phase
0.00	0.25	117.08 246.3	117.08 252.4
0.03	0.25	117.08 246.3	117.08 252.4
0.06	0.25	117.08 246.3	117.08 252.4
0.10	0.25	117.09 246.3	117.09 252.6
0.13	0.25	117.11 246.2	117.11 252.7
0.16	0.25	117.09 246.3	117.09 252.7
0.19	0.25	117.11 246.2	117.11 252.7
0.22	0.25	117.10 246.4	117.10 252.8
0.26	0.25	117.11 246.4	117.11 252.9
0.29	0.25	117.13 246.0	117.13 253.0
0.32	0.25	117.12 246.1	117.12 252.9
0.35	0.25	117.13 246.1	117.13 253.0
0.38	0.25	117.14 246.3	117.14 253.0
0.41	0.25	117.15 246.3	117.15 253.0
0.45	0.25	117.15 246.5	117.15 253.0
0.48	0.25	117.16 246.8	117.16 253.1
0.51	0.25	117.19 247.1	117.19 253.3
0.54	0.25	117.19 247.2	117.19 253.3
0.57	0.25	117.20 247.3	117.20 253.4
0.61	0.25	117.19 247.3	117.19 253.5
0.64	0.25	117.19 247.3	117.19 253.5
0.67	0.25	117.20 247.3	117.20 253.6
0.70	0.25	117.18 247.3	117.18 253.6
0.73	0.25	117.17 247.3	117.17 253.6
0.00	0.50	117.09 246.2	117.09 253.1
0.03	0.50	117.08 246.2	117.08 253.0
0.06	0.50	117.09 246.2	117.09 252.9
0.10	0.50	117.09 246.3	117.09 253.0
0.13	0.50	117.12 246.2	117.12 253.1
0.16	0.50	117.09 246.3	117.09 253.0
0.19	0.50	117.11 246.3	117.11 253.0
0.22	0.50	117.11 246.6	117.11 253.2
0.26	0.50	117.16 246.6	117.16 253.3
0.29	0.50	117.15 246.1	117.15 253.3
0.32	0.50	117.12 246.1	117.12 253.3
0.35	0.50	117.13 246.2	117.13 253.3
0.38	0.50	117.15 246.3	117.15 253.4
0.41	0.50	117.16 246.4	117.16 253.5
0.45	0.50	117.18 246.6	117.18 253.5
0.48	0.50	117.13 246.4	117.13 253.7
0.51	0.50	117.18 247.3	117.18 253.7
0.54	0.50	117.18 247.4	117.18 253.8
0.57	0.50	117.18 247.6	117.18 253.9
0.61	0.50	117.18 247.6	117.18 254.0
0.64	0.50	117.17 247.6	117.17 254.0
0.67	0.50	117.18 247.6	117.18 254.0
0.70	0.50	117.17 247.6	117.17 254.0
0.73	0.50	117.17 247.6	117.17 254.2
0.00	0.67	116.05 246.6	116.55 254.6
0.03	0.67	116.04 246.6	116.56 254.7
0.06	0.67	116.05 246.6	116.57 254.6
0.10	0.67	116.06 246.6	116.58 254.4
0.13	0.67	116.07 246.5	116.59 254.5
0.16	0.67	116.07 246.6	116.61 254.4
0.19	0.67	116.05 246.7	116.62 254.7
0.22	0.67	116.02 246.9	116.60 254.8
0.26	0.67	116.00 246.8	116.58 254.7
0.29	0.67	115.97 246.4	116.57 254.7

0.26	0.67	117.13 246.8	117.13 253.6
0.29	0.67	117.13 246.4	117.13 253.6
0.32	0.67	117.10 246.4	117.10 253.7
0.35	0.67	117.13 246.6	117.13 253.6
0.38	0.67	117.13 246.6	117.13 253.7
0.41	0.67	117.14 246.7	117.14 253.7
0.45	0.67	117.14 246.9	117.14 253.8
0.48	0.67	117.16 246.9	117.16 254.0
0.51	0.67	117.18 247.5	117.18 254.1
0.54	0.67	117.18 247.6	117.18 254.2
0.57	0.67	117.18 247.7	117.18 254.2
0.61	0.67	117.18 247.7	117.18 254.3
0.64	0.67	117.18 247.8	117.18 254.3
0.67	0.67	117.19 247.8	117.19 254.4
0.70	0.67	117.17 247.7	117.17 254.4
0.73	0.67	117.18 247.6	117.18 254.4

Exit Plane Data

y/w	z/h	X3 Plane		X4 Plane	
		spl phase	spl phase	spl phase	spl phase
0.00	0.25	116.08 246.3	115.93 255.4		
0.03	0.25	116.08 246.3	115.93 255.4		
0.06	0.25	116.10 246.3	115.92 255.3		
0.10	0.25	116.13 246.3	115.91 255.1		
0.13	0.25	116.12 246.2	115.89 255.3		
0.16	0.25	116.13 246.3	115.86 255.2		
0.19	0.25	116.10 246.2	115.87 255.5		
0.22	0.25	116.12 246.4	115.87 255.5		
0.26	0.25	116.10 246.4	115.87 255.5		
0.29	0.25	116.10 246.0	115.87 255.5		
0.32	0.25	116.08 246.1	115.86 255.5		
0.35	0.25	116.08 246.1	115.86 255.5		
0.38	0.25	116.09 246.3	115.86 255.4		
0.41	0.25	116.08 246.3	115.87 255.7		
0.45	0.25	116.10 246.5	115.86 255.6		
0.48	0.25	116.10 246.8	115.83 256.0		
0.51	0.25	116.10 247.1	115.86 256.4		
0.54	0.25	116.06 247.2	115.81 256.4		
0.57	0.25	116.04 247.3	115.75 256.5		
0.61	0.25	116.02 247.3	115.68 256.6		
0.64	0.25	115.99 247.3	115.77 256.8		
0.67	0.25	115.98 247.3	116.97 254.4		
0.70	0.25	115.98 247.3	117.02 254.3		
0.73	0.25	115.94 247.3	117.04 253.8		
0.00	0.50	116.06 246.2	116.61 254.6		
0.03	0.50	116.08 246.2	116.61 254.5		
0.06	0.50	116.06 246.2	116.62 254.5		
0.10	0.50	116.11 246.3	116.64 254.3		
0.13	0.50	116.14 246.2	116.69 254.4		
0.16	0.50	116.10 246.3	116.65 254.4		
0.19	0.50	116.07 246.3	116.64 254.3		
0.22	0.50	116.06 246.6	116.63 254.2		
0.26	0.50	116.04 246.6	116.63 254.2		
0.29	0.50	116.02 246.1	116.61 254.1		
0.32	0.50	116.00 246.1	116.62 254.1		
0.35	0.50	116.00 246.2	116.60 254.2		
0.38	0.50	116.02 246.3	116.60 254.2		
0.41	0.50	116.02 246.4	116.61 254.3		
0.45	0.50	116.02 246.6	116.62 254.4		
0.48	0.50	116.03 246.4	116.63 254.5		
0.51	0.50	116.02 247.3	116.66 254.6		
0.54	0.50	115.97 247.4	116.72 254.6		
0.57	0.50	115.95 247.6	116.72 254.6		
0.61	0.50	115.93 247.6	116.74 254.6		
0.64	0.50	115.90 247.6	116.76 254.6		
0.67	0.50	115.87 247.6	116.78 254.6		
0.70	0.50	115.88 247.6	116.82 254.5		
0.73	0.50	115.89 247.6	116.86 254.2		
0.00	0.67	116.05 246.6	116.55 254.6		
0.03	0.67	116.04 246.6	116.56 254.7		
0.06	0.67	116.05 246.6	116.57 254.6		
0.10	0.67	116.06 246.6	116.58 254.4		
0.13	0.67	116.07 246.5	116.59 254.5		
0.16	0.67	116.07 246.6	116.61 254.4		
0.19	0.67	116.05 246.7	116.62 254.7		
0.22	0.67	116.02 246.9	116.60 254.8		
0.26	0.67	116.00 246.8	116.58 254.7		
0.29	0.67	115.97 246.4	116.57 254.7		

0.32	0.67	115.98 246.4	116.56 254.7
0.35	0.67	115.96 246.6	116.56 254.8
0.38	0.67	115.99 246.6	116.56 254.8
0.41	0.67	115.98 246.7	116.56 254.9
0.45	0.67	115.98 246.9	116.56 255.0
0.48	0.67	116.00 246.9	116.56 255.1
0.51	0.67	115.99 247.5	116.56 255.1
0.54	0.67	115.91 247.6	116.62 255.1
0.57	0.67	115.89 247.7	116.62 255.1
0.61	0.67	115.87 247.7	116.63 255.2
0.64	0.67	115.84 247.8	116.65 255.3
0.67	0.67	115.81 247.8	116.64 255.2
0.70	0.67	115.82 247.7	116.66 255.1
0.73	0.67	115.82 247.6	116.71 254.9

Centerline Probe data

x/L	spl phase
-0.66	117.8 248.5
-0.61	117.7 247.7
-0.57	117.5 246.6
-0.52	117.1 245.3
-0.48	116.7 244.0
-0.43	116.1 242.4
-0.39	115.3 240.7
-0.34	114.4 238.7
-0.30	113.2 236.2
-0.25	111.8 232.9
-0.20	110.0 228.2
-0.16	107.7 220.4
-0.11	104.7 205.8
-0.07	101.8 176.2
-0.02	102.2 134.9
0.02	105.2 108.4
0.07	108.0 95.5
0.11	110.3 88.4
0.16	112.0 84.1
0.20	113.3 81.1
0.25	114.4 78.9
0.30	115.3 77.1
0.34	116.0 75.6
0.39	116.5 74.4
0.43	116.9 73.2
0.48	117.1 72.2
0.52	117.3 71.2
0.57	117.3 70.3
0.61	117.2 69.3
0.66	116.9 68.4
0.70	116.6 67.4
0.75	116.1 66.4
0.80	115.5 65.3
0.84	114.7 64.1
0.89	113.7 62.6
0.93	112.4 60.7
0.98	110.7 58.2
1.02	108.6 54.1
1.07	105.5 46.6
1.11	101.3 28.8
1.16	97.6 338.7
1.20	101.4 289.8
1.25	105.7 272.5
1.25	104.6 276.1
1.30	108.0 267.0
1.34	110.4 262.5
1.39	112.2 259.7
1.43	113.6 257.8
1.48	114.6 256.5

General Information:

Source Plane data = Planes 1 and 2

Exit Plane data = Planes 3 and 4

Plane locations (w. r. t. streamwise location of liner x = 0.0)

plane 1: -7.75 in.

Plane 3: +16.0

Planes 2 and 4 are 0.3 in. behind planes 1 and 3, respectively.

L = 11.0 in.

w = 4.7 in.

h = 2.0 in.

Hard wall

M=0.0

T = 47 F

1000 Hz

source plane data

y/w	z/h	spl	phase	spl	phase
0.00	0.25	108.31	65.5	108.31	105.4
0.03	0.25	108.00	64.2	108.00	105.5
0.06	0.25	108.03	64.3	108.03	105.6
0.10	0.25	107.95	64.1	107.95	105.6
0.13	0.25	108.01	63.5	108.01	105.8
0.16	0.25	107.96	63.8	107.96	105.9
0.19	0.25	107.99	64.0	107.99	106.1
0.22	0.25	108.00	64.1	108.00	106.4
0.26	0.25	107.96	63.8	107.96	106.4
0.29	0.25	107.96	63.6	107.96	106.4
0.32	0.25	108.02	63.4	108.02	106.5
0.35	0.25	107.88	63.1	107.88	106.5
0.38	0.25	107.92	62.5	107.92	106.5
0.41	0.25	107.84	62.3	107.84	106.5
0.45	0.25	107.82	61.9	107.82	106.5
0.48	0.25	107.84	61.6	107.84	106.7
0.51	0.25	107.88	61.4	107.88	106.7
0.54	0.25	107.85	61.2	107.85	106.8
0.57	0.25	107.87	61.2	107.87	106.9
0.61	0.25	107.82	61.0	107.82	107.1
0.64	0.25	107.75	60.7	107.75	107.1
0.67	0.25	107.72	60.2	107.72	107.3
0.70	0.25	107.73	60.2	107.73	107.3
0.73	0.25	107.69	59.8	107.69	107.2
0.00	0.50	108.31	65.3	108.31	106.8
0.03	0.50	108.04	64.5	108.04	106.9
0.06	0.50	108.01	64.4	108.01	106.9
0.10	0.50	107.97	64.8	107.97	107.1
0.13	0.50	107.88	63.7	107.88	107.1
0.16	0.50	108.00	63.7	108.00	107.2
0.19	0.50	107.99	64.4	107.99	107.2
0.22	0.50	108.01	64.5	108.01	107.3
0.26	0.50	107.97	64.0	107.97	107.4
0.29	0.50	107.96	63.4	107.96	107.4
0.32	0.50	108.00	63.1	108.00	107.4
0.35	0.50	107.89	62.6	107.89	107.4
0.38	0.50	107.90	62.2	107.90	107.6
0.41	0.50	107.86	61.8	107.86	107.7
0.45	0.50	107.86	61.6	107.86	107.7
0.48	0.50	107.81	61.3	107.81	107.7
0.51	0.50	107.81	61.9	107.81	107.8
0.54	0.50	108.10	61.5	108.10	107.8
0.57	0.50	107.96	61.0	107.96	107.9
0.61	0.50	107.89	61.0	107.89	108.1
0.64	0.50	107.81	60.9	107.81	108.0
0.67	0.50	107.72	60.5	107.72	108.1
0.70	0.50	107.69	60.2	107.69	108.1
0.73	0.50	107.64	60.2	107.64	108.2
0.00	0.67	108.27	65.9	108.27	107.9
0.03	0.67	108.06	64.8	108.06	107.7
0.06	0.67	108.07	65.0	108.07	107.9
0.10	0.67	107.99	64.7	107.99	108.1
0.13	0.67	108.00	64.2	108.00	108.1
0.16	0.67	108.02	64.3	108.02	108.3
0.19	0.67	108.01	64.5	108.01	108.4

0.22	0.67	108.02	64.6	108.02	108.4
0.26	0.67	107.98	64.3	107.98	108.4
0.29	0.67	107.99	64.4	107.99	108.3
0.32	0.67	107.96	64.1	107.96	108.4
0.35	0.67	107.85	63.4	107.85	108.2
0.38	0.67	107.85	63.1	107.85	108.4
0.41	0.67	107.84	62.8	107.84	108.2
0.45	0.67	107.87	62.6	107.87	108.3
0.48	0.67	107.90	62.7	107.90	108.5
0.51	0.67	107.97	62.5	107.97	108.6
0.54	0.67	108.01	61.8	108.01	109.0
0.57	0.67	108.03	62.1	108.03	108.8
0.61	0.67	107.96	61.9	107.96	108.9
0.64	0.67	107.96	62.0	107.96	108.9
0.67	0.67	107.93	61.9	107.93	109.0
0.70	0.67	107.85	61.0	107.85	108.9
0.73	0.67	107.81	61.2	107.81	108.9

Exit Plane Data

y/w	z/h	X3 Plane		X4 Plane	
		spl	phase	spl	phase
0.00	0.25	116.18	65.5	116.30	109.9
0.03	0.25	116.19	64.2	116.32	110.0
0.06	0.25	116.22	64.3	116.33	110.0
0.10	0.25	116.23	64.1	116.33	110.1
0.13	0.25	116.24	63.5	116.34	110.2
0.16	0.25	116.24	63.8	116.35	110.2
0.19	0.25	116.25	64.0	116.35	110.1
0.22	0.25	116.27	64.1	116.35	110.1
0.26	0.25	116.28	63.8	116.35	110.1
0.29	0.25	116.29	63.6	116.36	110.2
0.32	0.25	116.30	63.4	116.37	110.1
0.35	0.25	116.30	63.1	116.37	110.1
0.38	0.25	116.29	62.5	116.37	110.2
0.41	0.25	116.29	62.3	116.37	110.5
0.45	0.25	116.29	61.9	116.43	110.7
0.48	0.25	116.30	61.6	116.38	110.9
0.51	0.25	116.31	61.4	116.41	111.1
0.54	0.25	116.30	61.2	116.40	111.2
0.57	0.25	116.30	61.2	116.39	111.3
0.61	0.25	116.30	61.0	116.36	111.4
0.64	0.25	116.29	60.7	116.39	111.4
0.67	0.25	116.29	60.2	116.20	108.1
0.70	0.25	116.30	60.2	116.15	108.0
0.73	0.25	116.27	59.8	116.09	107.6
0.00	0.50	116.26	65.3	116.32	109.2
0.03	0.50	116.28	64.5	116.31	109.0
0.06	0.50	116.29	64.4	116.33	108.9
0.10	0.50	116.30	64.8	116.34	109.0
0.13	0.50	116.30	63.7	116.34	109.1
0.16	0.50	116.31	63.7	116.36	108.8
0.19	0.50	116.32	64.4	116.38	108.9
0.22	0.50	116.32	64.5	116.39	109.0
0.26	0.50	116.33	64.0	116.40	108.9
0.29	0.50	116.34	63.4	116.42	109.0
0.32	0.50	116.34	63.1	116.42	109.1
0.35	0.50	116.34	62.6	116.40	109.2
0.38	0.50	116.34	62.2	116.42	109.1
0.41	0.50	116.35	61.8	116.43	109.1
0.45	0.50	116.34	61.6	116.38	109.2
0.48	0.50	116.34	61.3	116.39	109.2
0.51	0.50	116.33	61.9	116.39	109.4
0.54	0.50	116.31	61.5	116.35	109.1
0.57	0.50	116.30	61.0	116.36	109.0
0.61	0.50	116.32	61.0	116.34	109.0
0.64	0.50	116.30	60.9	116.33	109.1
0.67	0.50	116.29	60.5	116.32	109.0
0.70	0.50	116.28	60.2	116.32	108.8
0.73	0.50	116.28	60.2	116.26	108.4
0.00	0.67	116.31	65.9	116.34	109.6
0.03	0.67	116.32	64.8	116.33	109.6
0.06	0.67	116.34	65.0	116.36	109.6
0.10	0.67	116.32	64.7	116.39	109.5
0.13	0.67	116.29	64.2	116.40	109.5
0.16	0.67	116.32	64.3	116.41	109.7
0.19	0.67	116.35	64.5	116.43	109.9
0.22	0.67	116.36	64.6	116.45	110.1
0.26	0.67	116.37	64.3	116.45	110.0
0.29	0.67	116.38	64.4	116.46	110.1

0.32	0.67	116.37	64.1	116.45	110.1
0.35	0.67	116.36	63.4	116.46	109.8
0.38	0.67	116.36	63.1	116.40	110.0
0.41	0.67	116.36	62.8	116.44	110.6
0.45	0.67	116.35	62.6	116.44	110.4
0.48	0.67	116.37	62.7	116.44	110.4
0.51	0.67	116.35	62.5	116.45	110.5
0.54	0.67	116.35	61.8	116.40	110.6
0.57	0.67	116.35	62.1	116.42	110.5
0.61	0.67	116.35	61.9	116.40	110.5
0.64	0.67	116.33	62.0	116.39	110.5
0.67	0.67	116.32	61.9	116.39	110.3
0.70	0.67	116.31	61.0	116.40	110.0
0.73	0.67	116.29	61.2	116.38	109.9

Centerline Probe data

x/L spl phase

-0.66	105.2	32.4
-0.61	104.9	335.6
-0.57	108.9	304.6
-0.52	112.0	291.7
-0.48	114.1	284.6
-0.43	115.5	279.8
-0.39	116.3	276.0
-0.34	116.6	272.8
-0.30	116.5	269.9
-0.25	115.9	266.8
-0.20	114.7	263.2
-0.16	112.8	258.3
-0.11	109.9	249.5
-0.07	105.3	227.9
-0.02	102.6	169.5
0.02	107.1	126.6
0.07	110.9	111.7
0.11	113.4	104.6
0.16	114.9	100.1
0.20	115.9	96.8
0.25	116.4	94.0
0.30	116.4	91.5
0.34	115.9	89.1
0.39	114.9	86.3
0.43	113.3	82.6
0.48	110.6	76.4
0.52	106.3	62.1
0.57	100.9	12.5
0.61	104.9	310.5
0.66	109.6	291.9
0.70	112.6	284.4
0.75	114.4	280.0
0.80	115.6	276.8
0.84	116.2	274.3
0.89	116.3	272.1
0.93	116.0	270.0
0.98	115.2	267.8
1.02	113.8	265.0
1.07	111.4	260.5
1.11	107.4	250.9
1.16	101.0	216.5
1.20	102.6	136.8
1.25	108.4	112.4
1.25	107.1	117.3
1.30	111.1	106.9
1.34	113.6	101.8
1.39	115.1	98.6
1.43	116.1	96.1
1.48	116.5	94.2

General Information:

Source Plane data = Planes 1 and 2

Exit Plane data = Planes 3 and 4

Plane locations (w. r. t. streamwise location of liner x = 0.0)

plane 1: -7.75 in.

Plane 3: +16.0

Planes 2 and 4 are 0.3 in. behind planes 1 and 3, respectively.

L = 11.0 in.

w = 4.7 in.

h = 2.0 in.

Hard wall

M=0.0

T = 47 F

1500 Hz

source plane data

y/w	z/h	spl	phase	spl	phase
0.00	0.25	114.58	212.9	114.58	5.8
0.03	0.25	114.73	211.3	114.73	5.4
0.06	0.25	114.85	210.3	114.85	5.3
0.10	0.25	115.02	208.9	115.02	4.8
0.13	0.25	115.23	207.8	115.23	4.3
0.16	0.25	115.42	206.1	115.42	3.7
0.19	0.25	115.65	204.7	115.65	3.3
0.22	0.25	115.89	203.1	115.89	2.7
0.26	0.25	116.19	201.4	116.19	1.8
0.29	0.25	116.47	199.5	116.47	0.9
0.32	0.25	116.78	197.7	116.78	359.5
0.35	0.25	117.11	196.0	117.11	358.1
0.38	0.25	117.41	194.3	117.41	356.7
0.41	0.25	117.73	192.8	117.73	355.2
0.45	0.25	118.07	191.3	118.07	353.8
0.48	0.25	118.37	190.1	118.37	352.3
0.51	0.25	118.61	189.1	118.61	350.9
0.54	0.25	118.88	188.2	118.88	349.5
0.57	0.25	119.16	186.9	119.16	348.3
0.61	0.25	119.40	186.3	119.40	347.2
0.64	0.25	119.62	185.4	119.62	346.0
0.67	0.25	119.85	184.8	119.85	344.7
0.70	0.25	120.01	183.8	120.01	343.3
0.73	0.25	120.13	183.5	120.13	343.0
0.00	0.50	114.53	213.1	114.53	8.5
0.03	0.50	114.63	211.6	114.63	8.2
0.06	0.50	114.80	210.7	114.80	7.7
0.10	0.50	114.94	209.3	114.94	7.3
0.13	0.50	115.15	208.0	115.15	6.7
0.16	0.50	115.35	206.5	115.35	6.0
0.19	0.50	115.56	205.0	115.56	5.1
0.22	0.50	115.82	203.4	115.82	4.3
0.26	0.50	116.10	201.6	116.10	3.5
0.29	0.50	116.40	199.9	116.40	2.3
0.32	0.50	116.78	197.7	116.78	0.9
0.35	0.50	117.07	196.2	117.07	359.7
0.38	0.50	117.38	194.6	117.38	358.2
0.41	0.50	117.70	193.1	117.70	356.7
0.45	0.50	118.00	191.6	118.00	355.2
0.48	0.50	118.32	190.7	118.32	353.7
0.51	0.50	118.57	189.9	118.57	352.2
0.54	0.50	118.85	189.0	118.85	351.2
0.57	0.50	119.09	187.9	119.09	350.2
0.61	0.50	119.37	187.1	119.37	348.5
0.64	0.50	119.61	186.3	119.61	347.6
0.67	0.50	119.83	185.6	119.83	346.8
0.70	0.50	120.03	185.0	120.03	345.1
0.73	0.50	120.16	184.1	120.16	343.7
0.00	0.67	114.42	213.6	114.42	10.2
0.03	0.67	114.58	211.6	114.58	9.8
0.06	0.67	114.74	210.7	114.74	9.4
0.10	0.67	114.88	209.3	114.88	8.9
0.13	0.67	115.12	207.9	115.12	8.2
0.16	0.67	115.33	206.5	115.33	7.5
0.19	0.67	115.54	205.3	115.54	6.7

0.22	0.67	115.82	203.7	115.82	5.7
0.26	0.67	116.08	202.1	116.08	4.7
0.29	0.67	116.45	200.1	116.45	3.6
0.32	0.67	116.77	198.7	116.77	2.1
0.35	0.67	117.03	196.4	117.03	0.9
0.38	0.67	117.43	195.4	117.43	359.4
0.41	0.67	117.73	193.3	117.73	357.8
0.45	0.67	118.07	192.4	118.07	356.2
0.48	0.67	118.29	191.4	118.29	354.7
0.51	0.67	118.58	189.9	118.58	353.2
0.54	0.67	118.88	188.7	118.88	352.5
0.57	0.67	119.21	187.9	119.21	351.3
0.61	0.67	119.36	187.4	119.36	350.0
0.64	0.67	119.57	186.7	119.57	349.0
0.67	0.67	119.77	186.0	119.77	347.9
0.70	0.67	120.01	185.1	120.01	346.3
0.73	0.67	120.18	184.4	120.18	345.5

Exit Plane Data

y/w	z/h	X3 Plane		X4 Plane	
		spl	phase	spl	phase
0.00	0.25	117.66	212.9	117.34	14.4
0.03	0.25	117.60	211.3	117.28	14.2
0.06	0.25	117.52	210.3	117.26	13.9
0.10	0.25	117.44	208.9	117.22	13.4
0.13	0.25	117.32	207.8	117.17	12.6
0.16	0.25	117.19	206.1	117.10	12.0
0.19	0.25	117.02	204.7	116.99	11.1
0.22	0.25	116.83	203.1	116.85	9.9
0.26	0.25	116.68	201.4	116.71	8.8
0.29	0.25	116.47	199.5	116.59	7.5
0.32	0.25	116.31	197.7	116.46	6.2
0.35	0.25	116.08	196.0	116.32	4.8
0.38	0.25	115.88	194.3	116.16	3.0
0.41	0.25	115.70	192.8	116.00	1.9
0.45	0.25	115.47	191.3	115.87	0.6
0.48	0.25	115.29	190.1	115.79	359.0
0.51	0.25	115.10	189.1	115.70	357.4
0.54	0.25	114.94	188.2	115.64	356.1
0.57	0.25	114.82	186.9	115.65	355.3
0.61	0.25	114.70	186.3	115.72	354.8
0.64	0.25	114.59	185.4	115.55	352.2
0.67	0.25	114.46	184.8	112.00	313.6
0.70	0.25	114.36	183.8	111.95	309.1
0.73	0.25	114.33	183.5	112.01	305.7
0.00	0.50	117.56	213.1	115.08	10.6
0.03	0.50	117.46	211.6	114.99	9.8
0.06	0.50	117.40	210.7	114.86	8.6
0.10	0.50	117.30	209.3	114.72	7.5
0.13	0.50	117.20	208.0	114.52	6.5
0.16	0.50	117.07	206.5	114.39	5.0
0.19	0.50	116.96	205.0	114.29	3.3
0.22	0.50	116.79	203.4	114.12	1.6
0.26	0.50	116.62	201.6	113.98	359.6
0.29	0.50	116.44	199.9	113.84	357.6
0.32	0.50	116.29	197.7	113.68	355.1
0.35	0.50	116.10	196.2	113.57	353.7
0.38	0.50	115.87	194.6	113.43	350.5
0.41	0.50	115.67	193.1	113.32	348.0
0.45	0.50	115.47	191.6	113.20	345.3
0.48	0.50	115.31	190.7	113.10	342.7
0.51	0.50	115.14	189.9	112.98	339.6
0.54	0.50	115.04	189.0	112.63	334.7
0.57	0.50	114.98	187.9	112.59	331.9
0.61	0.50	114.89	187.1	112.53	328.8
0.64	0.50	114.85	186.3	112.52	325.6
0.67	0.50	114.74	185.6	112.46	322.4
0.70	0.50	114.63	185.0	112.45	318.9
0.73	0.50	114.54	184.1	112.34	315.4
0.00	0.67	117.42	213.6	115.13	11.4
0.03	0.67	117.36	211.6	115.03	10.8
0.06	0.67	117.27	210.7	114.90	9.9
0.10	0.67	117.19	209.3	114.78	8.8
0.13	0.67	117.09	207.9	114.63	7.6
0.16	0.67	116.97	206.5	114.43	6.4
0.19	0.67	116.84	205.3	114.20	5.2
0.22	0.67	116.70	203.7	114.03	3.6
0.26	0.67	116.56	202.1	113.97	1.5
0.29	0.67	116.40	200.1	113.86	359.6

0.32	0.67	116.26	198.7	113.76	357.5
0.35	0.67	116.07	196.4	113.68	355.2
0.38	0.67	115.84	195.4	113.56	352.8
0.41	0.67	115.66	193.3	113.49	350.2
0.45	0.67	115.48	192.4	113.44	347.9
0.48	0.67	115.31	191.4	113.40	345.5
0.51	0.67	115.19	189.9	113.33	343.0
0.54	0.67	115.22	188.7	113.06	338.7
0.57	0.67	115.07	187.9	113.03	336.1
0.61	0.67	114.98	187.4	113.00	333.4
0.64	0.67	114.91	186.7	112.99	330.7
0.67	0.67	114.87	186.0	112.97	328.2
0.70	0.67	114.74	185.1	112.93	325.5
0.73	0.67	114.69	184.4	112.84	322.2

Centerline Probe data

x/L	spl	phase
-0.66	119.1	171.7
-0.61	119.0	165.9
-0.57	118.0	158.5
-0.52	115.8	147.6
-0.48	112.7	126.1
-0.43	110.8	84.6
-0.39	112.3	40.4
-0.34	115.1	17.5
-0.30	117.0	5.2
-0.25	117.8	356.5
-0.20	117.4	349.1
-0.16	116.0	340.1
-0.11	113.2	325.7
-0.07	109.3	294.0
-0.02	109.1	237.6
0.02	113.0	204.5
0.07	115.9	189.0
0.11	117.6	180.0
0.16	118.2	173.1
0.20	117.8	166.4
0.25	116.3	158.1
0.30	113.5	144.4
0.34	109.7	114.2
0.39	109.1	59.5
0.43	112.8	24.9
0.48	115.6	9.1
0.52	117.3	359.6
0.57	117.8	352.3
0.61	117.3	345.0
0.66	115.8	335.5
0.70	113.1	319.9
0.75	109.8	287.3
0.80	109.9	237.2
0.84	113.2	206.1
0.89	115.8	191.6
0.93	117.1	182.6
0.98	117.5	174.7
1.02	116.9	167.6
1.07	115.0	158.2
1.11	111.6	141.0
1.16	107.7	99.1
1.20	109.7	43.8
1.25	113.6	18.6
1.25	112.5	24.9
1.30	115.4	10.2
1.34	117.1	1.5
1.39	117.6	354.7
1.43	117.1	348.0
1.48	115.6	340.5

General Information:

Source Plane data = Planes 1 and 2

Exit Plane data = Planes 3 and 4

Plane locations (w. r. t. streamwise location of liner x = 0.0)

plane 1: -7.75 in.

Plane 3: +16.0

Planes 2 and 4 are 0.3 in. behind planes 1 and 3, respectively.

L = 11.0 in.

w = 4.7 in.

h = 2.0 in.

Hard wall

M=0.0

T = 47 F

2000 Hz

source plane data

y/w	z/h	spl	phase	spl	phase
0.00	0.25	114.39	30.4	114.39	178.3
0.03	0.25	114.16	28.3	114.16	178.5
0.06	0.25	114.19	28.8	114.19	178.4
0.10	0.25	114.21	29.2	114.21	178.7
0.13	0.25	114.25	29.9	114.25	179.0
0.16	0.25	114.30	30.8	114.30	179.7
0.19	0.25	114.39	32.0	114.39	180.6
0.22	0.25	114.47	33.3	114.47	181.1
0.26	0.25	114.50	34.4	114.50	182.2
0.29	0.25	114.58	35.7	114.58	182.6
0.32	0.25	114.68	37.3	114.68	183.4
0.35	0.25	114.70	38.4	114.70	183.5
0.38	0.25	114.77	39.8	114.77	183.2
0.41	0.25	114.85	41.3	114.85	183.8
0.45	0.25	114.95	42.9	114.95	184.7
0.48	0.25	115.07	44.5	115.07	186.3
0.51	0.25	115.23	46.3	115.23	188.1
0.54	0.25	115.38	47.8	115.38	191.4
0.57	0.25	115.47	49.0	115.47	193.9
0.61	0.25	115.60	50.2	115.60	196.5
0.64	0.25	115.68	51.0	115.68	199.4
0.67	0.25	115.74	51.8	115.74	201.9
0.70	0.25	115.90	52.8	115.90	203.1
0.73	0.25	115.94	53.3	115.94	205.8
0.00	0.50	114.36	30.3	114.36	180.9
0.03	0.50	114.17	28.6	114.17	180.5
0.06	0.50	114.19	29.0	114.19	180.6
0.10	0.50	114.21	29.4	114.21	180.5
0.13	0.50	114.25	30.1	114.25	181.1
0.16	0.50	114.30	31.1	114.30	181.8
0.19	0.50	114.38	32.5	114.38	182.4
0.22	0.50	114.46	33.8	114.46	182.7
0.26	0.50	114.49	34.8	114.49	183.8
0.29	0.50	114.57	36.2	114.57	185.0
0.32	0.50	114.68	37.7	114.68	185.6
0.35	0.50	114.67	38.7	114.67	185.6
0.38	0.50	114.76	40.3	114.76	184.9
0.41	0.50	114.85	41.8	114.85	185.4
0.45	0.50	114.97	43.5	114.97	186.2
0.48	0.50	115.08	45.4	115.08	187.5
0.51	0.50	115.22	47.5	115.22	189.5
0.54	0.50	115.38	49.0	115.38	194.8
0.57	0.50	115.50	50.3	115.50	197.4
0.61	0.50	115.61	51.4	115.61	200.0
0.64	0.50	115.73	52.4	115.73	202.9
0.67	0.50	115.78	53.0	115.78	205.4
0.70	0.50	115.87	54.2	115.87	206.1
0.73	0.50	115.93	54.3	115.93	207.9
0.00	0.67	114.30	30.8	114.30	183.1
0.03	0.67	114.09	29.0	114.09	183.2
0.06	0.67	114.13	29.4	114.13	182.5
0.10	0.67	114.15	29.8	114.15	183.0
0.13	0.67	114.20	30.5	114.20	183.4
0.16	0.67	114.26	31.5	114.26	183.8
0.19	0.67	114.35	33.0	114.35	184.3

0.22	0.67	114.43	34.3	114.43	185.1
0.26	0.67	114.46	35.4	114.46	186.1
0.29	0.67	114.57	36.7	114.57	187.3
0.32	0.67	114.65	38.2	114.65	187.4
0.35	0.67	114.66	39.2	114.66	187.5
0.38	0.67	114.74	40.7	114.74	186.7
0.41	0.67	114.84	42.3	114.84	187.4
0.45	0.67	114.99	44.1	114.99	188.1
0.48	0.67	115.14	45.9	115.14	188.6
0.51	0.67	115.29	47.6	115.29	190.9
0.54	0.67	115.46	49.1	115.46	197.8
0.57	0.67	115.61	50.6	115.61	200.0
0.61	0.67	115.71	51.6	115.71	201.8
0.64	0.67	115.88	52.8	115.88	204.4
0.67	0.67	115.97	53.9	115.97	207.8
0.70	0.67	115.99	54.4	115.99	208.3
0.73	0.67	116.05	54.8	116.05	210.0

Exit Plane Data

y/w	z/h	X3 Plane		X4 Plane	
		spl	phase	spl	phase
0.00	0.25	109.83	30.4	109.55	189.9
0.03	0.25	109.74	28.3	109.47	190.1
0.06	0.25	109.64	28.8	109.42	190.8
0.10	0.25	109.59	29.2	109.39	191.9
0.13	0.25	109.54	29.9	109.46	193.4
0.16	0.25	109.46	30.8	109.47	195.1
0.19	0.25	109.36	32.0	109.39	196.1
0.22	0.25	109.26	33.3	109.33	196.4
0.26	0.25	109.18	34.4	109.23	197.0
0.29	0.25	109.08	35.7	109.16	197.9
0.32	0.25	109.00	37.3	109.07	199.0
0.35	0.25	108.92	38.4	109.00	199.8
0.38	0.25	108.78	39.8	108.86	200.1
0.41	0.25	108.62	41.3	108.73	201.3
0.45	0.25	108.51	42.9	108.74	203.3
0.48	0.25	108.34	44.5	108.69	205.6
0.51	0.25	108.21	46.3	108.65	207.8
0.54	0.25	108.16	47.8	108.65	211.0
0.57	0.25	108.08	49.0	108.86	216.4
0.61	0.25	108.04	50.2	109.12	222.2
0.64	0.25	108.01	51.0	108.81	219.8
0.67	0.25	107.99	51.8	112.63	128.7
0.70	0.25	107.94	52.8	112.86	126.8
0.73	0.25	107.91	53.3	113.14	125.5
0.00	0.50	109.77	30.3	111.65	136.7
0.03	0.50	109.65	28.6	111.69	135.9
0.06	0.50	109.57	29.0	111.75	135.3
0.10	0.50	109.51	29.4	111.84	134.7
0.13	0.50	109.47	30.1	111.91	134.2
0.16	0.50	109.40	31.1	111.91	134.3
0.19	0.50	109.29	32.5	111.91	134.7
0.22	0.50	109.18	33.8	111.86	134.6
0.26	0.50	109.14	34.8	111.79	135.1
0.29	0.50	109.06	36.2	111.72	135.6
0.32	0.50	108.94	37.7	111.64	136.0
0.35	0.50	108.86	38.7	111.52	136.4
0.38	0.50	108.71	40.3	111.45	137.1
0.41	0.50	108.59	41.8	111.34	137.8
0.45	0.50	108.46	43.5	111.28	138.4
0.48	0.50	108.34	45.4	111.18	139.1
0.51	0.50	108.24	47.5	111.14	139.3
0.54	0.50	108.18	49.0	111.52	136.6
0.57	0.50	108.11	50.3	111.46	136.5
0.61	0.50	108.06	51.4	111.42	136.4
0.64	0.50	108.08	52.4	111.39	136.1
0.67	0.50	108.15	53.0	111.48	135.7
0.70	0.50	107.99	54.2	111.65	134.1
0.73	0.50	107.86	54.3	111.96	132.3
0.00	0.67	109.62	30.8	111.46	138.7
0.03	0.67	109.57	29.0	111.48	138.3
0.06	0.67	109.43	29.4	111.52	137.7
0.10	0.67	109.40	29.8	111.57	137.2
0.13	0.67	109.34	30.5	111.62	136.8
0.16	0.67	109.31	31.5	111.67	136.8
0.19	0.67	109.22	33.0	111.67	137.2
0.22	0.67	109.15	34.3	111.68	137.4
0.26	0.67	109.06	35.4	111.53	138.5
0.29	0.67	109.00	36.7	111.46	138.9

0.32	0.67	108.87	38.2	111.34	139.6
0.35	0.67	108.74	39.2	111.23	140.1
0.38	0.67	108.62	40.7	111.12	140.6
0.41	0.67	108.55	42.3	111.03	141.4
0.45	0.67	108.38	44.1	110.89	142.3
0.48	0.67	108.20	45.9	110.73	143.4
0.51	0.67	108.11	47.6	110.59	144.2
0.54	0.67	108.14	49.1	110.91	141.2
0.57	0.67	107.99	50.6	110.79	141.8
0.61	0.67	108.02	51.6	110.77	142.1
0.64	0.67	108.03	52.8	110.74	142.2
0.67	0.67	108.12	53.9	110.70	141.7
0.70	0.67	107.93	54.4	110.81	140.7
0.73	0.67	107.83	54.8	111.12	138.5

Centerline Probe data

x/L	spl	phase
-0.66	110.6	17.3
-0.61	110.3	310.1
-0.57	114.6	275.5
-0.52	117.1	260.8
-0.48	117.6	251.2
-0.43	116.4	241.5
-0.39	113.2	223.8
-0.34	108.3	176.6
-0.30	111.0	109.8
-0.25	115.3	85.8
-0.20	117.1	74.8
-0.16	117.1	65.7
-0.11	115.1	53.5
-0.07	110.9	28.1
-0.02	108.3	320.4
0.02	113.3	275.1
0.07	116.5	259.0
0.11	117.4	249.8
0.16	116.5	240.2
0.20	113.7	224.1
0.25	109.3	184.8
0.30	110.6	119.5
0.34	114.9	90.3
0.39	117.2	77.7
0.43	117.4	68.6
0.48	116.0	57.5
0.52	112.5	36.9
0.57	108.6	343.9
0.61	112.2	287.2
0.66	115.9	266.3
0.70	117.4	255.6
0.75	117.1	246.4
0.80	114.9	233.0
0.84	110.7	204.8
0.89	109.2	138.4
0.93	113.9	98.3
0.98	116.8	83.2
1.02	117.7	74.2
1.07	116.7	65.2
1.11	113.9	50.7
1.16	108.8	13.6
1.20	109.7	301.2
1.25	114.6	271.5
1.25	113.2	275.6
1.30	116.3	261.6
1.34	117.2	253.4
1.39	116.0	244.3
1.43	112.8	228.1
1.48	108.2	189.4

General Information:

Source Plane data = Planes 1 and 2

Exit Plane data = Planes 3 and 4

Plane locations (w. r. t. streamwise location of liner x = 0.0)

plane 1: -7.75 in.

Plane 3: +16.0

Planes 2 and 4 are 0.3 in. behind planes 1 and 3, respectively.

L = 11.0 in.

w = 4.7 in.

h = 2.0 in.

Hard wall

M=0.0

T = 47 F

2500 Hz

source plane data

y/w	z/h	spl phase	spl phase
0.00	0.25	109.11 147.8	109.11 348.3
0.03	0.25	109.37 145.7	109.37 348.0
0.06	0.25	109.44 145.8	109.44 347.7
0.10	0.25	109.54 145.6	109.54 347.4
0.13	0.25	109.66 145.5	109.66 347.1
0.16	0.25	109.76 145.5	109.76 347.0
0.19	0.25	109.86 145.7	109.86 346.9
0.22	0.25	109.96 145.8	109.96 346.8
0.26	0.25	110.11 145.6	110.11 346.5
0.29	0.25	110.25 145.7	110.25 346.2
0.32	0.25	110.41 146.0	110.41 345.7
0.35	0.25	110.58 145.9	110.58 345.4
0.38	0.25	110.75 146.1	110.75 344.6
0.41	0.25	110.92 146.4	110.92 344.2
0.45	0.25	111.09 146.8	111.09 343.9
0.48	0.25	111.25 147.5	111.25 343.7
0.51	0.25	111.40 148.3	111.40 343.8
0.54	0.25	111.54 149.2	111.54 344.2
0.57	0.25	111.74 149.8	111.74 344.6
0.61	0.25	111.90 150.2	111.90 344.9
0.64	0.25	112.07 150.5	112.07 345.4
0.67	0.25	112.21 150.8	112.21 345.6
0.70	0.25	112.31 151.5	112.31 345.4
0.73	0.25	112.42 151.6	112.42 345.7
0.00	0.50	109.03 147.1	109.03 351.1
0.03	0.50	109.29 145.6	109.29 350.9
0.06	0.50	109.37 145.6	109.37 350.7
0.10	0.50	109.49 145.5	109.49 350.5
0.13	0.50	109.61 145.5	109.61 350.3
0.16	0.50	109.72 145.6	109.72 350.0
0.19	0.50	109.82 145.9	109.82 349.7
0.22	0.50	109.94 146.1	109.94 349.2
0.26	0.50	110.08 146.0	110.08 349.3
0.29	0.50	110.22 146.1	110.22 348.9
0.32	0.50	110.37 146.3	110.37 348.5
0.35	0.50	110.57 146.2	110.57 347.9
0.38	0.50	110.72 146.5	110.72 347.3
0.41	0.50	110.89 146.9	110.89 347.0
0.45	0.50	111.06 147.5	111.06 346.6
0.48	0.50	111.24 148.5	111.24 346.7
0.51	0.50	111.39 149.9	111.39 346.8
0.54	0.50	111.57 150.8	111.57 347.7
0.57	0.50	111.74 151.3	111.74 348.3
0.61	0.50	111.92 151.8	111.92 348.4
0.64	0.50	112.07 152.5	112.07 349.2
0.67	0.50	112.23 152.7	112.23 349.5
0.70	0.50	112.34 153.0	112.34 348.9
0.73	0.50	112.45 153.1	112.45 348.9
0.00	0.67	109.05 147.6	109.05 353.8
0.03	0.67	109.33 145.9	109.33 353.6
0.06	0.67	109.40 145.9	109.40 353.4
0.10	0.67	109.50 145.8	109.50 353.2
0.13	0.67	109.62 145.8	109.62 352.9
0.16	0.67	109.73 145.9	109.73 352.8
0.19	0.67	109.81 146.3	109.81 352.5
0.22	0.67	109.93 146.5	109.93 352.1

0.26	0.67	110.08 146.4	110.08 351.9
0.29	0.67	110.21 146.6	110.21 351.7
0.32	0.67	110.38 146.7	110.38 351.0
0.35	0.67	110.56 146.6	110.56 350.4
0.38	0.67	110.72 147.0	110.72 349.8
0.41	0.67	110.90 147.4	110.90 349.3
0.45	0.67	111.06 148.1	111.06 349.0
0.48	0.67	111.21 149.0	111.21 348.9
0.51	0.67	111.36 149.9	111.36 349.2
0.54	0.67	111.52 150.8	111.52 350.7
0.57	0.67	111.67 151.6	111.67 350.9
0.61	0.67	111.85 152.0	111.85 351.3
0.64	0.67	112.00 152.8	112.00 351.7
0.67	0.67	112.15 153.4	112.15 352.2
0.70	0.67	112.31 153.3	112.31 351.6
0.73	0.67	112.42 153.4	112.42 351.6

Exit Plane Data

y/w	z/h	X3 Plane		X4 Plane	
		spl phase	spl phase	spl phase	spl phase
0.00	0.25	110.42 147.8	110.84 1.3		
0.03	0.25	110.47 145.7	110.86 1.3		
0.06	0.25	110.52 145.8	110.86 1.3		
0.10	0.25	110.55 145.6	110.84 1.4		
0.13	0.25	110.60 145.5	110.82 1.6		
0.16	0.25	110.63 145.5	110.79 1.6		
0.19	0.25	110.65 145.7	110.77 1.2		
0.22	0.25	110.70 145.8	110.79 0.6		
0.26	0.25	110.71 145.6	110.79 0.2		
0.29	0.25	110.74 145.7	110.80 359.8		
0.32	0.25	110.74 146.0	110.79 359.4		
0.35	0.25	110.79 145.9	110.80 358.9		
0.38	0.25	110.81 146.1	110.81 358.3		
0.41	0.25	110.81 146.4	110.84 358.6		
0.45	0.25	110.82 146.8	110.83 359.0		
0.48	0.25	110.82 147.5	110.78 359.3		
0.51	0.25	110.80 148.3	110.76 359.3		
0.54	0.25	110.74 149.2	110.69 359.9		
0.57	0.25	110.70 149.8	110.54 1.6		
0.61	0.25	110.66 150.2	110.32 3.3		
0.64	0.25	110.61 150.5	110.49 1.5		
0.67	0.25	110.56 150.8	112.17 328.8		
0.70	0.25	110.54 151.5	112.07 327.1		
0.73	0.25	110.46 151.6	111.94 325.6		
0.00	0.50	110.61 147.1	112.70 343.3		
0.03	0.50	110.68 145.6	112.73 342.9		
0.06	0.50	110.69 145.6	112.76 342.5		
0.10	0.50	110.75 145.5	112.79 342.0		
0.13	0.50	110.78 145.5	112.81 341.5		
0.16	0.50	110.79 145.6	112.80 341.1		
0.19	0.50	110.80 145.9	112.77 340.7		
0.22	0.50	110.83 146.1	112.76 340.2		
0.26	0.50	110.84 146.0	112.73 340.0		
0.29	0.50	110.83 146.1	112.70 339.7		
0.32	0.50	110.84 146.3	112.68 339.3		
0.35	0.50	110.87 146.2	112.64 339.1		
0.38	0.50	110.92 146.5	112.60 338.8		
0.41	0.50	110.92 146.9	112.57 338.5		
0.45	0.50	110.94 147.5	112.53 338.4		
0.48	0.50	110.94 148.5	112.49 338.2		
0.51	0.50	110.92 149.9	112.45 337.9		
0.54	0.50	110.81 150.8	112.44 336.1		
0.57	0.50	110.76 151.3	112.38 335.7		
0.61	0.50	110.72 151.8	112.39 335.5		
0.64	0.50	110.68 152.5	112.33 334.6		
0.67	0.50	110.58 152.7	112.25 333.9		
0.70	0.50	110.57 153.0	112.19 332.8		
0.73	0.50	110.52 153.1	112.11 331.4		
0.00	0.67	110.75 147.6	112.69 344.8		
0.03	0.67	110.78 145.9	112.74 344.9		
0.06	0.67	110.82 145.9	112.76 344.5		
0.10	0.67	110.84 145.8	112.78 344.1		
0.13	0.67	110.87 145.8	112.81 343.8		
0.16	0.67	110.91 145.9	112.83 343.5		
0.19	0.67	110.92 146.3	112.83 343.8		
0.22	0.67	110.92 146.5	112.84 343.8		
0.26	0.67	110.91 146.4	112.79 343.5		
0.29	0.67	110.91 146.6	112.76 343.2		
0.32	0.67	110.93 146.7	112.73 342.9		

0.35	0.67	110.95 146.6	112.71 342.8
0.38	0.67	111.01 147.0	112.67 342.4
0.41	0.67	111.01 147.4	112.63 342.3
0.45	0.67	111.03 148.1	112.60 342.1
0.48	0.67	111.03 149.0	112.55 342.1
0.51	0.67	111.01 149.9	112.52 342.0
0.54	0.67	110.89 150.8	112.53 340.6
0.57	0.67	110.83 151.6	112.47 340.3
0.61	0.67	110.79 152.0	112.49 340.1
0.64	0.67	110.71 152.8	112.41 339.8
0.67	0.67	110.65 153.4	112.37 339.2
0.70	0.67	110.65 153.3	112.30 338.4
0.73	0.67	110.61 153.4	112.26 337.1

Centerline Probe data

x/L	spl phase
-0.66	116.7 145.8
-0.61	116.1 127.1
-0.57	114.0 97.9
-0.52	112.6 50.8
-0.48	114.3 6.7
-0.43	116.2 340.5
-0.39	116.1 319.5
-0.34	114.2 295.5
-0.30	111.3 254.0
-0.25	111.8 197.4
-0.20	114.7 162.8
-0.16	115.7 141.0
-0.11	114.9 118.4
-0.07	112.9 85.1
-0.02	112.5 37.0
0.02	114.4 359.9
0.07	115.5 336.8
0.11	114.7 315.9
0.16	112.1 285.8
0.20	110.3 231.9
0.25	113.0 184.5
0.30	115.0 159.2
0.34	115.0 139.5
0.39	113.1 115.0
0.43	110.5 71.7
0.48	111.7 19.1
0.52	114.1 348.0
0.57	114.7 327.1
0.61	113.2 304.4
0.66	110.3 266.9
0.70	110.4 210.2
0.75	113.3 174.0
0.80	114.5 152.8
0.84	113.6 131.8
0.89	110.9 100.2
0.93	109.4 46.9
0.98	112.3 2.6
1.02	114.2 338.3
1.07	114.1 318.1
1.11	112.0 291.5
1.16	109.6 242.9
1.20	111.6 191.7
1.25	113.8 164.2
1.25	113.8 173.1
1.30	114.8 152.1
1.34	113.8 131.2
1.39	110.9 97.1
1.43	110.4 39.4
1.48	113.1 2.9

General Information:	0.64 0.50 110.16 134.3 110.33 134.6
	0.67 0.50 110.04 135.4 110.40 134.2
Source Plane data = Planes 1 and 2	0.70 0.50 110.05 135.3 110.36 133.7
Exit Plane data = Planes 3 and 4	0.73 0.50 110.06 135.1 110.39 133.5
	0.77 0.50 110.14 134.8 110.44 133.1
Plane locations (w. r. t. streamwise location of liner x = 0.0)	0.80 0.50 110.21 135.4 110.61 133.6
plane 1: -7.75 in.	0.83 0.50 110.25 135.6 110.70 133.6
Plane 3: +16.0	0.86 0.50 110.30 135.7 110.80 133.6
Planes 2 and 4 are 0.3 in. behind planes 1 and 3, respectively.	0.89 0.50 110.35 135.9 110.91 133.6
L = 11.0 in.	0.93 0.50 110.40 136.2 111.02 133.7
w = 4.7 in.	0.96 0.50 110.45 136.4 111.14 133.8
h = 2.0 in.	0.99 0.50 110.50 136.7 111.26 133.9
	Centerline Probe data
	x/L spl phase
	-0.70 115.9 113.2
Hardwall	-0.66 116.1 112.8
M = 0.1	-0.61 116.2 111.9
T = 68 F	-0.57 116.2 111.4
	-0.52 116.2 110.3
	-0.48 115.9 109.4
500 Hz	-0.43 115.6 108.9
	-0.39 115.1 108.5
source plane data	-0.34 114.6 107.5
	-0.30 113.9 106.1
y/w z/h spl phase spl phase	-0.25 113.0 104.6
0.03 0.50 116.22 114.7 116.06 114.9	-0.20 111.9 103.0
0.06 0.50 116.04 114.4 115.93 114.4	-0.16 110.5 100.9
0.10 0.50 115.95 114.1 115.90 114.3	-0.11 108.7 97.5
0.13 0.50 115.91 114.2 115.87 113.9	-0.07 106.4 92.0
0.16 0.50 115.94 114.1 115.88 113.7	-0.02 103.4 81.8
0.19 0.50 115.88 113.4 115.89 113.1	0.02 99.5 57.6
0.22 0.50 115.93 114.0 115.85 113.6	0.07 98.2 10.9
0.26 0.50 115.91 113.3 115.79 113.6	0.11 101.6 335.2
0.29 0.50 115.91 113.9 115.82 113.4	0.16 105.2 320.9
0.32 0.50 115.93 113.3 115.87 113.2	0.20 107.8 313.7
0.35 0.50 115.94 113.2 115.89 113.1	0.25 109.8 310.5
0.38 0.50 115.93 112.7 115.91 112.9	0.30 111.3 308.1
0.41 0.50 115.99 112.7 115.90 112.9	0.34 112.5 306.3
0.45 0.50 115.97 112.7 115.83 113.4	0.39 113.5 305.2
0.48 0.50 116.04 113.0 115.88 113.3	0.43 114.3 304.3
0.51 0.50 115.91 113.2 115.91 113.2	0.48 114.9 303.6
0.54 0.50 116.00 113.5 115.92 113.0	0.52 115.3 304.0
0.57 0.50 116.06 113.1 115.93 112.9	0.57 115.6 303.6
0.61 0.50 116.05 113.1 115.99 113.0	0.61 115.9 303.3
0.64 0.50 116.11 113.1 116.03 112.9	0.66 116.0 303.0
0.67 0.50 116.10 113.0 116.01 113.5	0.70 116.0 302.8
0.70 0.50 116.11 112.9 115.99 113.2	0.75 115.8 302.6
0.73 0.50 116.08 113.2 116.03 113.1	0.80 115.5 302.5
0.77 0.50 116.10 113.1 116.04 112.9	0.84 115.1 303.1
0.80 0.50 116.20 113.3 116.11 113.4	0.89 114.5 303.3
0.83 0.50 116.24 113.4 116.15 113.5	0.93 113.8 302.9
0.86 0.50 116.28 113.5 116.19 113.6	0.98 112.8 302.6
0.89 0.50 116.33 113.7 116.23 113.7	1.02 111.6 301.6
0.93 0.50 116.37 113.8 116.27 113.9	1.07 110.1 300.8
0.96 0.50 116.42 114.0 116.32 114.0	1.11 108.3 299.9
0.99 0.50 116.48 114.1 116.37 114.2	1.16 105.5 298.3
Exit Plane Data	1.20 101.6 293.7
X3 Plane X4 Plane	1.25 94.2 273.3
y/w z/h spl phase spl phase	1.30 92.4 170.6
0.03 0.50 110.29 138.5 110.08 142.7	1.34 100.9 144.6
0.06 0.50 110.15 137.6 109.97 141.9	1.39 105.1 138.6
0.10 0.50 110.07 137.1 109.91 141.0	1.43 108.0 135.8
0.13 0.50 110.01 136.4 109.87 140.0	1.48 110.0 135.1
0.16 0.50 110.01 136.2 109.82 140.0	1.52 111.5 134.9
0.19 0.50 110.04 135.6 109.83 139.5	1.57 112.9 134.6
0.22 0.50 109.90 136.9 109.81 138.5	1.61 113.8 135.1
0.26 0.50 109.96 136.1 109.82 138.1	1.66 114.6 133.9
0.29 0.50 109.92 135.7 109.85 137.6	1.70 115.1 135.0
0.32 0.50 109.97 135.7 109.90 137.0	
0.35 0.50 110.00 135.1 109.92 136.4	
0.38 0.50 109.97 134.8 109.92 136.1	
0.41 0.50 110.01 134.8 109.88 136.4	
0.45 0.50 109.91 135.2 109.93 135.8	
0.48 0.50 109.96 135.2 109.93 135.3	
0.51 0.50 109.99 135.1 109.99 135.1	
0.54 0.50 110.02 135.1 110.00 134.6	
0.57 0.50 110.10 135.5 110.10 134.6	
0.61 0.50 110.17 134.7 110.13 134.7	

General Information:	0.67 0.50 114.08 39.4 114.17 37.6
	0.70 0.50 114.06 38.4 114.11 36.7
Source Plane data = Planes 1 and 2	0.73 0.50 114.14 37.9 114.06 36.3
Exit Plane data = Planes 3 and 4	0.77 0.50 114.13 37.7 114.02 35.6
	0.80 0.50 114.17 38.0 114.14 36.0
Plane locations (w. r. t. streamwise location of liner x = 0.0)	0.83 0.50 114.20 38.0 114.17 35.7
plane 1: -7.75 in.	0.86 0.50 114.22 38.1 114.19 35.5
Plane 3: +16.0	0.89 0.50 114.25 38.2 114.22 35.3
Planes 2 and 4 are 0.3 in. behind planes 1 and 3, respectively.	0.93 0.50 114.28 38.2 114.25 35.1
L = 11.0 in.	0.96 0.50 114.30 38.3 114.28 34.9
w = 4.7 in.	0.99 0.50 114.33 38.4 114.32 34.8
h = 2.0 in.	Centerline Probe data
	x/L spl phase
	-0.70 113.8 339.4
	-0.66 111.9 335.2
Hardwall	-0.61 109.0 325.8
M = 0.1	-0.57 104.8 302.3
T = 68 F	-0.52 102.9 248.2
	-0.48 107.0 210.0
	-0.43 110.6 195.1
	-0.39 113.0 189.3
	-0.34 114.5 184.9
1000 Hz	-0.30 115.5 181.7
source plane data	-0.25 116.0 179.3
y/w z/h spl phase	-0.20 116.0 177.0
0.03 0.50 114.15 343.9 113.99 347.4	-0.16 115.5 174.9
0.06 0.50 113.61 340.7 113.27 335.0	-0.11 114.6 172.1
0.10 0.50 113.75 341.8 113.25 335.7	-0.07 113.1 169.4
0.13 0.50 113.83 342.6 113.28 335.5	-0.02 110.8 164.4
0.16 0.50 113.89 342.8 113.12 336.0	0.02 107.0 151.8
0.19 0.50 113.97 342.4 113.29 335.2	0.07 102.2 113.3
0.22 0.50 113.94 341.6 113.26 336.3	0.11 104.2 52.6
0.26 0.50 113.94 342.0 113.41 338.0	0.16 109.0 29.7
0.29 0.50 113.93 343.1 113.42 338.5	0.20 112.0 21.6
0.32 0.50 113.95 342.4 113.42 337.9	0.25 114.1 17.5
0.35 0.50 114.01 342.3 113.58 338.3	0.30 115.3 15.3
0.38 0.50 113.82 341.1 113.43 338.4	0.34 116.0 13.2
0.41 0.50 113.76 339.4 113.68 338.3	0.39 116.2 11.5
0.45 0.50 113.78 338.6 113.68 339.7	0.43 116.0 10.0
0.48 0.50 113.83 338.3 113.78 339.7	0.48 115.3 8.6
0.51 0.50 113.83 339.4 113.83 339.4	0.52 114.0 8.0
0.54 0.50 113.86 338.6 113.98 339.2	0.57 112.1 5.2
0.57 0.50 113.81 337.0 114.02 338.5	0.61 108.9 359.1
0.61 0.50 113.76 337.2 114.09 336.2	0.66 103.6 342.0
0.64 0.50 113.71 335.5 114.04 335.2	0.70 99.2 269.4
0.67 0.50 113.59 334.8 114.03 337.0	0.75 105.9 223.2
0.70 0.50 113.60 334.1 114.05 336.1	0.80 110.3 212.7
0.73 0.50 113.26 332.6 114.16 335.5	0.84 112.9 209.1
0.77 0.50 112.89 327.5 114.11 334.3	0.89 114.5 207.9
0.80 0.50 113.14 329.1 114.39 335.5	0.93 115.5 206.4
0.83 0.50 113.04 327.7 114.49 335.1	0.98 116.0 204.7
0.86 0.50 112.93 326.2 114.58 334.8	1.02 116.0 203.7
0.89 0.50 112.81 324.6 114.69 334.4	1.07 115.5 202.1
0.93 0.50 112.69 323.0 114.79 334.0	1.11 114.6 201.1
0.96 0.50 112.56 321.3 114.90 333.6	1.16 112.9 200.4
0.99 0.50 112.42 319.5 115.01 333.2	1.20 110.4 198.6
Exit Plane Data	1.25 106.0 191.0
X3 Plane X4 Plane	1.30 97.4 153.5
y/w z/h spl phase spl phase	1.34 101.9 60.3
0.03 0.50 113.98 41.2 114.14 47.5	1.39 108.3 44.6
0.06 0.50 114.00 40.9 114.13 46.5	1.43 111.8 39.5
0.10 0.50 113.97 40.2 114.10 45.8	1.48 114.0 38.7
0.13 0.50 114.02 39.6 114.08 44.6	1.52 115.2 39.2
0.16 0.50 113.99 39.5 114.08 44.4	1.57 115.9 38.3
0.19 0.50 114.00 39.2 114.02 44.8	1.61 116.1 37.3
0.22 0.50 113.96 40.5 114.00 43.7	1.66 115.8 37.0
0.26 0.50 113.97 40.1 114.02 42.8	1.70 115.0 35.8
0.29 0.50 113.98 39.2 114.03 41.9	
0.32 0.50 113.96 38.9 114.00 41.5	
0.35 0.50 114.03 38.5 114.04 40.8	
0.38 0.50 113.98 37.8 114.03 40.4	
0.41 0.50 114.00 37.7 113.94 41.0	
0.45 0.50 113.94 39.5 113.98 40.0	
0.48 0.50 113.97 38.8 113.97 39.4	
0.51 0.50 113.97 38.7 113.97 38.7	
0.54 0.50 114.04 38.1 113.98 38.2	
0.57 0.50 114.06 37.7 114.04 37.2	
0.61 0.50 114.12 37.4 114.07 38.6	
0.64 0.50 114.17 36.6 114.13 38.5	

General Information: 0.67 0.50 116.85 338.0 116.39 327.5
 0.70 0.50 116.79 335.7 116.24 323.7
 Source Plane data = Planes 1 and 2 0.73 0.50 116.78 333.6 116.03 319.6
 Exit Plane data = Planes 3 and 4 0.77 0.50 116.54 330.3 115.75 315.0
 0.80 0.50 116.37 328.3 115.49 311.4
 Plane locations (w. r. t. streamwise location of
 liner x = 0.0) 0.83 0.50 116.24 326.2 115.21 307.1
 plane 1: -7.75 in. 0.86 0.50 116.11 324.0 114.90 302.8
 Plane 3: +16.0 0.89 0.50 115.97 321.8 114.58 298.3
 Planes 2 and 4 are 0.3 in. behind planes 1 and 3,
 respectively. 0.93 0.50 115.83 319.5 114.24 293.8
 L = 11.0 in. 0.96 0.50 115.69 317.2 113.89 289.2
 w = 4.7 in. 0.99 0.50 115.55 314.9 113.51 284.6
 h = 2.0 in.

Hardwall
 M = 0.1
 T = 68 F

1500 Hz

source plane data

y/w	z/h	spl	phase
0.03	0.50	104.49	149.1
0.06	0.50	104.79	148.4
0.10	0.50	104.92	148.6
0.13	0.50	105.05	148.7
0.16	0.50	105.24	148.6
0.19	0.50	105.50	148.4
0.22	0.50	105.84	148.1
0.26	0.50	106.19	148.0
0.29	0.50	106.52	148.8
0.32	0.50	106.92	148.2
0.35	0.50	107.28	148.0
0.38	0.50	107.73	147.2
0.41	0.50	108.13	146.7
0.45	0.50	108.53	146.5
0.48	0.50	108.88	146.3
0.51	0.50	109.21	146.9
0.54	0.50	109.56	146.5
0.57	0.50	109.88	146.2
0.61	0.50	110.15	145.8
0.64	0.50	110.45	145.6
0.67	0.50	110.70	145.1
0.70	0.50	110.95	144.8
0.73	0.50	111.16	145.0
0.77	0.50	111.44	144.2
0.80	0.50	112.03	144.0
0.83	0.50	112.37	143.6
0.86	0.50	112.72	143.3
0.89	0.50	113.06	142.9
0.93	0.50	113.40	142.5
0.96	0.50	113.75	142.2
0.99	0.50	114.09	141.8

Exit Plane Data

X3 Plane		X4 Plane	
y/w	z/h	spl	phase
0.03	0.50	118.40	7.8
0.06	0.50	118.39	6.4
0.10	0.50	118.43	5.3
0.13	0.50	118.41	4.1
0.16	0.50	118.39	2.6
0.19	0.50	118.34	1.4
0.22	0.50	118.30	2.4
0.26	0.50	118.20	0.3
0.29	0.50	118.13	358.4
0.32	0.50	118.03	356.2
0.35	0.50	117.94	354.0
0.38	0.50	117.83	351.9
0.41	0.50	117.67	349.7
0.45	0.50	117.54	350.7
0.48	0.50	117.38	347.9
0.51	0.50	117.23	345.5
0.54	0.50	117.09	343.1
0.57	0.50	117.01	340.8
0.61	0.50	117.06	338.8
0.64	0.50	117.03	336.5

Centerline Probe data

x/L	spl	phase
-0.70	109.2	146.9
-0.66	113.3	121.6
-0.61	116.2	110.6
-0.57	117.6	104.4
-0.52	118.0	99.9
-0.48	117.3	95.3
-0.43	115.6	89.1
-0.39	112.5	78.8
-0.34	107.7	48.5
-0.30	107.5	342.4
-0.25	112.4	311.1
-0.20	115.5	299.6
-0.16	117.2	293.7
-0.11	117.6	289.2
-0.07	117.0	285.4
-0.02	115.2	279.7
0.02	111.9	266.7
0.07	107.2	231.4
0.11	108.3	168.7
0.16	112.9	142.2
0.20	115.9	132.0
0.25	117.4	126.8
0.30	117.7	123.6
0.34	117.0	119.3
0.39	115.1	113.1
0.43	111.7	100.2
0.48	106.8	63.1
0.52	108.2	0.9
0.57	113.0	334.6
0.61	115.9	324.9
0.66	117.4	319.8
0.70	117.8	316.3
0.75	117.0	312.4
0.80	115.1	306.4
0.84	111.6	296.0
0.89	106.3	261.1
0.93	107.8	193.0
0.98	112.8	167.0
1.02	115.7	157.9
1.07	117.2	153.0
1.11	117.4	149.5
1.16	116.6	147.4
1.20	114.5	143.0
1.25	110.6	130.8
1.30	104.6	87.3
1.34	107.9	16.0
1.39	113.1	355.8
1.43	115.9	348.6
1.48	117.2	345.5
1.52	117.3	345.4
1.57	116.3	342.0
1.61	113.8	335.8
1.66	109.4	321.0
1.70	104.6	265.9

General Information: 0.70 0.50 114.73 312.3 116.43 293.2
 0.73 0.50 114.61 313.5 116.48 291.7
 Source Plane data = Planes 1 and 2 0.77 0.50 114.60 306.4 116.73 289.9
 Exit Plane data = Planes 3 and 4 0.80 0.50 114.19 313.3 116.53 291.1
 0.83 0.50 113.96 315.3 116.60 290.4
 Plane locations (w. r. t. streamwise location of
 liner x = 0.0) 0.86 0.50 113.71 317.4 116.67 289.7
 0.89 0.50 113.46 319.7 116.75 289.0
 plane 1: -7.75 in. 0.93 0.50 113.20 322.0 116.83 288.4
 Plane 3: +16.0 0.96 0.50 112.93 324.5 116.92 287.8
 Planes 2 and 4 are 0.3 in. behind planes 1 and 3,
 respectively. 0.99 0.50 112.66 327.1 117.02 287.2

Centerline Probe data
 x/L spl phase
 -0.70 116.7 37.7
 -0.66 116.4 29.1
 -0.61 114.4 16.6
 -0.57 110.7 349.7
 -0.52 109.3 290.9
 -0.48 113.2 252.2
 -0.43 116.0 236.3
 -0.39 116.9 227.9
 -0.34 116.4 218.7
 -0.30 114.0 204.8
 -0.25 109.7 173.5
 -0.20 109.4 109.7
 -0.16 113.7 76.4
 -0.11 116.1 62.8
 -0.07 116.7 54.3
 -0.02 115.7 45.4
 0.02 112.8 28.8
 0.07 108.8 346.5
 0.11 110.9 289.5
 0.16 114.6 266.1
 0.20 116.3 254.6
 0.25 116.3 246.0
 0.30 114.7 235.9
 0.34 110.9 213.7
 0.39 108.1 155.6
 0.43 112.2 109.7
 0.48 115.4 92.5
 0.52 116.6 85.4
 0.57 116.2 76.4
 0.61 113.9 64.0
 0.66 109.6 34.6
 0.70 109.0 330.3
 0.75 113.3 296.5
 0.80 115.8 282.8
 0.84 116.5 275.7
 0.89 115.5 267.3
 0.93 112.6 251.8
 0.98 108.2 209.0
 1.02 110.5 149.1
 1.07 114.4 125.7
 1.11 116.3 114.7
 1.16 116.4 108.4
 1.20 114.8 100.0
 1.25 110.8 81.2
 1.30 106.8 20.7
 1.34 111.6 329.5
 1.39 115.1 313.7
 1.43 116.4 305.4
 1.48 115.9 299.1
 1.52 113.5 291.3
 1.57 108.4 261.2
 1.61 108.3 187.6
 1.66 113.4 157.0
 1.70 115.9 145.9

Hardwall
 M = 0.1
 T = 68 F
 2000 Hz

source plane data
 y/w z/h spl phase spl phase
 0.03 0.50 116.95 21.5 118.17 24.0
 0.06 0.50 116.53 17.5 118.18 11.7
 0.10 0.50 116.58 18.8 118.10 12.2
 0.13 0.50 116.65 20.1 118.03 12.9
 0.16 0.50 116.72 21.5 117.94 14.2
 0.19 0.50 116.68 22.4 117.82 14.9
 0.22 0.50 116.67 23.3 117.73 17.0
 0.26 0.50 116.68 24.4 117.61 19.8
 0.29 0.50 116.66 27.1 117.51 21.0
 0.32 0.50 116.65 27.9 117.40 22.7
 0.35 0.50 116.66 29.0 117.27 24.3
 0.38 0.50 116.59 29.6 117.16 26.3
 0.41 0.50 116.55 30.5 117.03 28.4
 0.45 0.50 116.56 32.1 116.84 32.4
 0.48 0.50 116.54 33.8 116.77 35.2
 0.51 0.50 116.65 37.7 116.65 37.7
 0.54 0.50 116.72 39.2 116.64 40.5
 0.57 0.50 116.78 40.7 116.63 43.0
 0.61 0.50 116.88 42.2 116.59 44.5
 0.64 0.50 116.88 42.9 116.60 46.1
 0.67 0.50 116.93 44.2 116.64 51.2
 0.70 0.50 117.00 45.3 116.77 53.2
 0.73 0.50 116.79 45.2 116.84 54.7
 0.77 0.50 116.25 42.0 116.80 54.7
 0.80 0.50 116.79 48.5 116.68 62.8
 0.83 0.50 116.80 50.0 116.70 66.5
 0.86 0.50 116.82 51.5 116.72 70.3
 0.89 0.50 116.84 53.0 116.76 74.2
 0.93 0.50 116.86 54.5 116.80 78.3
 0.96 0.50 116.88 56.0 116.84 82.5
 0.99 0.50 116.90 57.5 116.90 86.8

Exit Plane Data
 X3 Plane X4 Plane
 y/w z/h spl phase spl phase
 0.03 0.50 117.20 302.2 116.20 315.5
 0.06 0.50 117.20 301.3 116.22 313.6
 0.10 0.50 117.11 300.3 116.29 311.2
 0.13 0.50 117.06 299.1 116.32 309.0
 0.16 0.50 117.07 297.9 116.35 308.4
 0.19 0.50 117.02 297.9 116.37 308.5
 0.22 0.50 116.91 301.2 116.36 306.9
 0.26 0.50 116.85 300.2 116.36 305.2
 0.29 0.50 116.78 299.7 116.32 303.6
 0.32 0.50 116.69 299.3 116.30 302.4
 0.35 0.50 116.54 299.3 116.27 301.3
 0.38 0.50 116.45 299.1 116.21 301.3
 0.41 0.50 116.37 297.7 116.10 302.2
 0.45 0.50 116.18 301.1 116.08 301.0
 0.48 0.50 116.06 299.6 116.00 300.0
 0.51 0.50 115.92 299.1 115.92 299.1
 0.54 0.50 115.75 298.8 115.86 298.1
 0.57 0.50 115.61 299.2 115.82 297.0
 0.61 0.50 115.40 302.4 115.85 298.4
 0.64 0.50 115.21 304.4 116.41 295.5
 0.67 0.50 114.92 310.7 116.44 294.1

General Information: 0.64 0.50 113.60 219.2 113.74 217.9
0.67 0.50 113.43 223.8 113.70 215.8
Source Plane data = Planes 1 and 2 0.70 0.50 113.35 222.3 113.61 213.9
Exit Plane data = Planes 3 and 4 0.73 0.50 113.32 221.2 113.54 211.7
0.77 0.50 113.50 218.6 113.49 209.4
Plane locations (w. r. t. streamwise location of 0.80 0.50 113.35 219.2 113.47 208.9
liner x = 0.0) 0.83 0.50 113.31 218.9 113.45 207.4
plane 1: -7.75 in. 0.86 0.50 113.26 218.7 113.42 206.0
Plane 3: +16.0 0.89 0.50 113.22 218.4 113.40 204.6
Planes 2 and 4 are 0.3 in. behind planes 1 and 3, 0.93 0.50 113.17 218.3 113.38 203.2
respectively. 0.96 0.50 113.12 218.2 113.36 201.8
L = 11.0 in. 0.99 0.50 113.07 218.1 113.35 200.5
w = 4.7 in.
h = 2.0 in.

Hardwall
M = 0.1
T = 68 F

2500 Hz

source plane data

y/w	z/h	spl	phase	spl	phase
0.03	0.50	113.01	285.4	113.45	288.2
0.06	0.50	113.28	283.8	113.67	284.8
0.10	0.50	113.24	284.0	113.66	284.4
0.13	0.50	113.19	283.8	113.68	284.0
0.16	0.50	113.19	283.5	113.70	283.5
0.19	0.50	113.23	282.9	113.71	282.9
0.22	0.50	113.27	282.5	113.69	283.1
0.26	0.50	113.29	281.8	113.68	283.4
0.29	0.50	113.31	283.1	113.70	282.6
0.32	0.50	113.36	282.1	113.71	282.1
0.35	0.50	113.43	281.6	113.74	281.4
0.38	0.50	113.53	280.5	113.75	280.8
0.41	0.50	113.62	279.7	113.76	280.4
0.45	0.50	113.67	279.4	113.74	281.9
0.48	0.50	113.74	279.0	113.73	281.3
0.51	0.50	113.74	280.8	113.74	280.8
0.54	0.50	113.79	280.3	113.76	280.7
0.57	0.50	113.87	280.1	113.78	280.4
0.61	0.50	113.90	279.9	113.84	280.0
0.64	0.50	114.00	279.4	113.92	279.6
0.67	0.50	114.03	279.1	113.92	282.1
0.70	0.50	114.09	279.3	113.93	281.4
0.73	0.50	114.18	279.2	113.94	281.3
0.77	0.50	114.32	276.5	113.95	280.8
0.80	0.50	114.37	278.2	113.97	281.7
0.83	0.50	114.45	278.0	113.99	282.0
0.86	0.50	114.53	277.9	114.01	282.3
0.89	0.50	114.62	277.7	114.04	282.7
0.93	0.50	114.71	277.6	114.06	283.2
0.96	0.50	114.81	277.5	114.09	283.7
0.99	0.50	114.90	277.4	114.11	284.2

Exit Plane Data

		X3 Plane	X4 Plane
y/w	z/h	spl	phase
0.03	0.50	114.01	240.6
0.06	0.50	113.99	239.0
0.10	0.50	113.97	237.4
0.13	0.50	113.93	235.7
0.16	0.50	113.93	234.0
0.19	0.50	113.92	232.9
0.22	0.50	113.87	235.8
0.26	0.50	113.85	233.5
0.29	0.50	113.82	231.8
0.32	0.50	113.82	229.9
0.35	0.50	113.77	228.3
0.38	0.50	113.75	226.6
0.41	0.50	113.77	224.8
0.45	0.50	113.73	227.8
0.48	0.50	113.72	225.3
0.51	0.50	113.72	223.6
0.54	0.50	113.74	222.1
0.57	0.50	113.71	220.8
0.61	0.50	113.65	220.2

Centerline Probe data

x/L	spl	phase
-0.70	113.7	280.8
-0.66	111.6	235.8
-0.61	113.6	186.6
-0.57	116.1	160.8
-0.52	116.6	142.9
-0.48	115.3	122.7
-0.43	112.6	88.2
-0.39	112.5	37.3
-0.34	115.3	2.0
-0.30	116.6	341.6
-0.25	116.0	323.7
-0.20	113.6	297.8
-0.16	111.2	247.6
-0.11	113.6	198.5
-0.07	116.0	175.1
-0.02	116.5	159.0
0.02	115.2	138.2
0.07	112.7	102.7
0.11	112.9	53.1
0.16	115.2	22.4
0.20	115.8	3.4
0.25	114.5	344.5
0.30	111.4	312.0
0.34	111.1	251.9
0.39	114.6	215.1
0.43	116.3	196.8
0.48	115.8	180.4
0.52	113.2	160.1
0.57	110.6	110.5
0.61	113.2	60.6
0.66	115.7	37.7
0.70	116.0	21.5
0.75	114.1	1.6
0.80	110.5	321.1
0.84	111.7	263.7
0.89	115.1	236.0
0.93	116.2	219.7
0.98	115.2	202.5
1.02	112.2	172.9
1.07	111.0	116.2
1.11	114.2	77.1
1.16	115.9	60.6
1.20	115.6	46.3
1.25	112.9	23.0
1.30	109.8	330.4
1.34	112.9	277.8
1.39	115.5	256.5
1.43	115.7	241.9
1.48	113.7	223.6
1.52	110.2	184.2
1.57	112.2	124.2
1.61	115.6	98.6
1.66	116.5	84.3
1.70	115.2	68.5

General Information:	0.64 0.50 113.05 173.2 112.93 175.4
	0.67 0.50 112.89 175.8 112.57 174.6
Source Plane data = Planes 1 and 2	0.70 0.50 113.40 176.4 112.75 171.1
Exit Plane data = Planes 3 and 4	0.73 0.50 113.93 181.8 112.38 173.0
	0.77 0.50 113.69 183.2 112.44 173.4
Plane locations (w. r. t. streamwise location of liner x = 0.0)	0.80 0.50 114.27 180.4 113.24 172.9
plane 1: -7.75 in.	0.83 0.50 114.65 181.1 113.51 172.9
Plane 3: +16.0	0.86 0.50 115.04 181.9 113.80 172.9
Planes 2 and 4 are 0.3 in. behind planes 1 and 3, respectively.	0.89 0.50 115.46 182.8 114.11 173.0
L = 11.0 in.	0.93 0.50 115.90 183.8 114.43 173.1
w = 4.7 in.	0.96 0.50 116.37 184.8 114.78 173.2
h = 2.0 in.	0.99 0.50 116.86 185.9 115.14 173.3
	Centerline Probe data
	x/L spl phase
	-0.89 111.5 125.7
	-0.84 112.4 126.7
Hardwall	-0.80 113.3 123.6
M = 0.2	-0.75 113.7 122.7
T = 46 F	-0.70 113.5 121.9
	-0.66 113.6 121.5
500 Hz	-0.61 113.6 117.5
	-0.57 113.3 118.0
source plane data	-0.52 112.4 116.3
	-0.48 111.6 119.1
y/w z/h spl phase spl phase	-0.43 111.1 122.7
0.03 0.50 113.42 126.1 114.22 120.0	-0.39 110.7 124.7
0.06 0.50 114.50 124.1 113.94 118.3	-0.34 110.5 123.6
0.10 0.50 113.38 119.7 114.24 117.2	-0.30 109.3 124.9
0.13 0.50 113.94 124.0 113.76 119.5	-0.25 108.2 118.7
0.16 0.50 113.44 117.7 113.58 118.9	-0.20 106.6 117.0
0.19 0.50 113.46 119.7 113.35 118.9	-0.16 103.9 106.3
0.22 0.50 113.89 115.4 113.17 117.8	-0.11 100.2 94.3
0.26 0.50 113.84 118.8 113.21 118.8	-0.07 97.3 56.7
0.29 0.50 113.14 115.4 113.17 118.3	-0.02 97.5 0.3
0.32 0.50 113.41 112.9 112.73 118.4	0.02 102.1 337.0
0.35 0.50 113.53 117.9 112.66 117.9	0.07 103.6 328.2
0.38 0.50 113.87 119.4 112.83 122.4	0.11 105.7 325.5
0.41 0.50 113.36 119.3 112.89 119.0	0.16 107.4 324.7
0.45 0.50 113.74 123.0 113.27 122.1	0.20 108.6 325.1
0.48 0.50 113.75 121.8 113.15 122.5	0.25 110.2 328.9
0.51 0.50 113.52 121.9 113.52 121.9	0.30 111.3 330.9
0.54 0.50 113.81 119.7 113.02 124.5	0.34 111.6 332.2
0.57 0.50 113.47 121.7 113.58 124.8	0.39 112.4 331.7
0.61 0.50 113.95 120.0 113.99 123.6	0.43 113.2 333.1
0.64 0.50 114.75 119.1 113.94 120.7	0.48 113.2 332.3
0.67 0.50 114.70 118.9 114.27 121.5	0.52 113.5 330.6
0.70 0.50 115.03 118.7 114.16 120.9	0.57 113.3 330.3
0.73 0.50 115.01 115.9 114.45 120.7	0.61 112.9 332.3
0.77 0.50 114.80 115.3 114.64 119.9	0.66 112.7 333.1
0.80 0.50 115.32 119.0 115.14 121.7	0.70 112.1 333.4
0.83 0.50 115.56 119.2 115.47 121.6	0.75 111.4 335.7
0.86 0.50 115.82 119.4 115.82 121.6	0.80 110.5 336.2
0.89 0.50 116.09 119.6 116.20 121.5	0.84 109.5 338.7
0.93 0.50 116.37 119.8 116.61 121.4	0.89 108.6 340.1
0.96 0.50 116.67 120.1 117.03 121.2	0.93 107.4 338.3
0.99 0.50 116.99 120.4 117.49 121.1	0.98 105.3 336.5
Exit Plane Data	1.02 101.5 334.2
X3 Plane X4 Plane	1.07 96.5 320.9
y/w z/h spl phase spl phase	1.11 83.5 284.4
0.03 0.50 112.53 184.3 112.19 182.2	1.16 94.9 187.3
0.06 0.50 112.11 185.0 112.27 180.4	1.20 100.2 167.7
0.10 0.50 111.64 182.3 111.56 182.4	1.25 103.6 170.7
0.13 0.50 111.76 178.5 111.44 181.7	1.30 105.4 169.6
0.16 0.50 111.37 180.7 111.31 182.1	1.34 107.8 169.2
0.19 0.50 111.04 179.9 111.07 180.0	1.39 109.0 173.2
0.22 0.50 111.64 177.9 111.34 181.4	1.43 110.7 174.0
0.26 0.50 111.51 178.3 111.08 179.1	1.48 111.6 175.2
0.29 0.50 111.53 180.2 111.04 177.5	1.52 112.1 172.6
0.32 0.50 111.01 177.4 111.23 176.0	
0.35 0.50 112.05 178.9 111.14 177.9	
0.38 0.50 111.58 180.9 111.60 174.5	
0.41 0.50 111.87 179.3 111.38 174.6	
0.45 0.50 111.93 177.3 110.95 173.0	
0.48 0.50 111.87 178.0 111.75 175.8	
0.51 0.50 111.60 175.2 111.60 175.2	
0.54 0.50 112.00 175.2 111.97 172.5	
0.57 0.50 112.14 178.8 111.68 173.3	
0.61 0.50 112.11 177.1 111.85 175.6	

General Information:	0.70 0.50 116.05 117.4 115.90 113.9
Source Plane data = Planes 1 and 2	0.73 0.50 115.87 117.2 115.73 112.5
Exit Plane data = Planes 3 and 4	0.77 0.50 115.99 119.6 115.75 113.3
	0.80 0.50 116.45 117.4 116.17 111.8
	0.83 0.50 116.67 117.6 116.33 111.4
Plane locations (w. r. t. streamwise location of liner x = 0.0)	0.86 0.50 116.90 117.8 116.50 110.9
plane 1: -7.75 in.	0.89 0.50 117.14 118.0 116.67 110.5
Plane 3: +16.0	0.93 0.50 117.39 118.2 116.84 110.0
Planes 2 and 4 are 0.3 in. behind planes 1 and 3, respectively.	0.96 0.50 117.66 118.5 117.03 109.6
L = 11.0 in.	0.99 0.50 117.94 118.8 117.22 109.2
w = 4.7 in.	
h = 2.0 in.	
	Centerline Probe data
	x/L spl phase
Hardwall	-0.89 114.8 355.5
M = 0.2	-0.84 114.3 353.7
T = 46 F	-0.80 113.3 352.7
	-0.75 111.6 349.9
	-0.70 109.3 347.6
	-0.66 105.4 332.8
	-0.61 100.8 291.3
	-0.57 103.2 236.0
1000 Hz	-0.52 108.0 215.0
source plane data	-0.48 111.0 207.8
y/w z/h spl phase spl phase	-0.43 112.9 206.6
0.03 0.50 108.42 359.5 109.48 346.8	-0.39 113.9 204.9
0.06 0.50 108.42 356.5 108.84 346.7	-0.34 114.6 204.4
0.10 0.50 108.49 356.3 108.83 347.1	-0.30 114.5 204.0
0.13 0.50 108.58 355.5 109.14 349.3	-0.25 114.2 204.3
0.16 0.50 108.78 355.6 108.99 351.6	-0.20 113.2 203.1
0.19 0.50 108.73 352.4 109.15 350.0	-0.16 111.6 202.0
0.22 0.50 109.04 352.4 108.96 350.1	-0.11 108.7 198.2
0.26 0.50 108.96 352.1 109.25 349.5	-0.07 104.1 187.0
0.29 0.50 109.09 349.6 109.14 348.0	-0.02 98.5 129.7
0.32 0.50 108.80 351.6 109.11 348.6	0.02 104.1 71.4
0.35 0.50 109.15 349.0 109.23 347.6	0.07 108.7 60.4
0.38 0.50 109.16 345.9 109.34 347.1	0.11 111.8 57.8
0.41 0.50 109.34 345.9 109.22 348.2	0.16 113.4 56.9
0.45 0.50 109.09 346.6 109.38 347.3	0.20 114.5 55.8
0.48 0.50 109.24 347.7 109.22 348.8	0.25 115.0 56.7
0.51 0.50 109.30 347.6 109.30 347.6	0.30 114.9 56.5
0.54 0.50 109.40 346.5 109.15 346.6	0.34 114.6 58.7
0.57 0.50 109.31 347.3 109.13 347.6	0.39 113.5 60.3
0.61 0.50 109.33 345.5 109.30 347.0	0.43 111.7 59.3
0.64 0.50 108.95 343.8 109.08 346.4	0.48 108.7 57.4
0.67 0.50 109.26 344.6 109.26 344.5	0.52 103.3 44.3
0.70 0.50 109.18 344.2 109.09 345.2	0.57 95.3 344.3
0.73 0.50 109.54 339.0 109.15 345.4	0.61 103.3 278.5
0.77 0.50 109.00 341.6 109.10 342.8	0.66 108.6 268.4
0.80 0.50 109.13 341.8 109.11 342.9	0.70 111.6 266.0
0.83 0.50 109.09 341.4 109.09 342.1	0.75 113.4 267.9
0.86 0.50 109.03 341.1 109.07 341.3	0.80 114.3 268.7
0.89 0.50 108.97 340.9 109.04 340.5	0.84 114.9 268.7
0.93 0.50 108.91 340.6 109.01 339.6	0.89 114.9 270.3
0.96 0.50 108.84 340.4 108.98 338.7	0.93 114.3 269.3
0.99 0.50 108.76 340.2 108.95 337.7	0.98 113.4 270.9
Exit Plane Data	1.02 111.6 271.5
X3 Plane X4 Plane	1.07 108.7 269.5
y/w z/h spl phase spl phase	1.11 103.3 266.9
0.03 0.50 114.80 121.4 114.31 125.9	1.16 90.3 201.4
0.06 0.50 114.84 121.8 114.59 123.0	1.20 102.8 117.8
0.10 0.50 114.68 122.1 114.65 123.8	1.25 108.4 113.0
0.13 0.50 114.70 121.4 114.68 122.7	1.30 111.7 111.8
0.16 0.50 114.60 120.8 114.63 122.4	1.34 113.4 114.9
0.19 0.50 114.63 122.3 114.90 122.4	1.39 114.4 116.8
0.22 0.50 114.62 120.0 114.50 123.0	1.43 115.1 115.1
0.26 0.50 114.79 119.0 114.72 122.0	1.48 114.9 116.8
0.29 0.50 114.53 118.5 114.72 121.8	1.52 114.4 111.4
0.32 0.50 114.50 118.0 114.51 121.1	
0.35 0.50 114.63 120.1 114.81 121.4	
0.38 0.50 114.55 119.4 114.61 117.8	
0.41 0.50 115.01 118.6 114.84 117.0	
0.45 0.50 114.99 117.6 115.01 116.3	
0.48 0.50 114.83 117.6 115.03 116.2	
0.51 0.50 114.95 116.8 114.95 116.8	
0.54 0.50 114.93 116.5 114.99 113.3	
0.57 0.50 115.00 117.0 114.85 112.7	
0.61 0.50 115.31 116.4 115.24 115.0	
0.64 0.50 116.01 115.6 116.01 115.7	
0.67 0.50 116.06 116.2 116.18 113.8	

General Information:	0.70 0.50 112.24 84.3 112.64 84.1
	0.73 0.50 107.98 92.1 112.59 85.6
Source Plane data = Planes 1 and 2	0.77 0.50 107.31 93.5 112.45 84.7
Exit Plane data = Planes 3 and 4	0.80 0.50 109.33 92.4 112.78 87.9
	0.83 0.50 108.89 94.5 112.87 89.3
Plane locations (w. r. t. streamwise location of liner x = 0.0)	0.86 0.50 108.42 96.6 112.96 90.8
plane 1: -7.75 in.	0.89 0.50 107.93 98.9 113.06 92.4
Plane 3: +16.0	0.93 0.50 107.41 101.2 113.16 94.1
Planes 2 and 4 are 0.3 in. behind planes 1 and 3, respectively.	0.96 0.50 106.87 103.7 113.28 95.9
L = 11.0 in.	0.99 0.50 106.30 106.3 113.40 97.7
w = 4.7 in.	Centerline Probe data
h = 2.0 in.	x/L spl phase
	-0.89 112.4 250.3
	-0.84 108.2 228.2
	-0.80 106.1 172.4
	-0.75 110.5 131.6
	-0.70 114.0 118.4
Hardwall	-0.66 116.0 113.8
M = 0.2	-0.61 116.9 112.0
T = 46 F	-0.57 116.7 110.6
	-0.52 115.4 106.6
1500 Hz	-0.48 112.5 99.6
source plane data	-0.43 107.8 78.8
y/w z/h spl phase spl phase	-0.39 105.3 14.0
0.03 0.50 111.90 160.3 110.35 139.4	-0.34 110.6 334.7
0.06 0.50 111.75 156.5 111.60 134.9	-0.30 114.0 324.7
0.10 0.50 111.82 154.2 111.55 133.9	-0.25 115.9 321.1
0.13 0.50 111.86 151.9 111.06 133.7	-0.20 116.4 319.8
0.16 0.50 111.64 150.5 110.98 132.9	-0.16 115.8 318.6
0.19 0.50 111.44 145.8 111.33 131.7	-0.11 114.0 315.2
0.22 0.50 111.62 143.1 111.64 129.8	-0.07 110.3 306.3
0.26 0.50 111.74 141.5 111.79 129.1	-0.02 104.4 268.4
0.29 0.50 111.65 137.7 111.87 128.2	0.02 107.2 195.4
0.32 0.50 111.82 134.3 112.40 127.2	0.07 112.4 175.9
0.35 0.50 112.20 130.8 112.50 126.0	0.11 115.3 171.3
0.38 0.50 112.79 127.5 112.66 124.3	0.16 116.6 170.3
0.41 0.50 112.97 125.8 113.15 122.9	0.20 116.6 170.1
0.45 0.50 113.37 122.4 113.59 121.7	0.25 115.5 168.5
0.48 0.50 113.67 120.3 113.75 120.8	0.30 113.0 163.9
0.51 0.50 114.04 118.4 114.04 118.4	0.34 108.6 150.6
0.54 0.50 114.34 115.7 114.37 117.9	0.39 103.4 88.2
0.57 0.50 114.30 116.9 114.45 116.8	0.43 109.2 36.0
0.61 0.50 114.81 114.3 115.08 115.1	0.48 113.6 24.9
0.64 0.50 115.28 112.3 115.35 114.9	0.52 115.9 20.8
0.67 0.50 115.58 109.8 115.55 113.2	0.57 116.7 21.4
0.70 0.50 115.85 109.7 115.78 112.8	0.61 116.3 20.6
0.73 0.50 116.02 106.8 115.92 112.6	0.66 114.8 18.6
0.77 0.50 116.50 105.3 116.20 111.6	0.70 111.6 12.4
0.80 0.50 117.30 104.1 116.85 109.8	0.75 106.1 346.2
0.83 0.50 117.81 102.8 117.23 108.8	0.80 105.6 271.5
0.86 0.50 118.35 101.6 117.61 107.8	0.84 111.4 244.2
0.89 0.50 118.91 100.6 118.00 106.8	0.89 114.8 237.5
0.93 0.50 119.49 99.6 118.41 105.9	0.93 116.4 235.7
0.96 0.50 120.09 98.7 118.82 104.9	0.98 116.8 235.6
0.99 0.50 120.71 97.8 119.24 104.0	1.02 115.9 235.5
Exit Plane Data	1.07 113.7 232.7
X3 Plane X4 Plane	1.11 109.3 224.1
y/w z/h spl phase spl phase	1.16 101.5 172.0
0.03 0.50 112.92 74.9 112.93 84.4	1.20 107.2 97.2
0.06 0.50 112.75 74.3 113.04 81.9	1.25 112.9 85.0
0.10 0.50 112.75 74.4 113.02 79.6	1.30 115.5 82.8
0.13 0.50 112.74 75.1 112.95 78.5	1.34 116.7 84.7
0.16 0.50 112.69 74.0 112.91 78.2	1.39 116.6 85.6
0.19 0.50 112.62 74.4 112.73 77.5	1.43 115.1 83.1
0.22 0.50 112.50 73.5 112.70 78.0	1.48 112.1 79.1
0.26 0.50 112.39 73.1 112.70 77.7	1.52 106.1 55.2
0.29 0.50 112.33 74.7 112.56 78.4	
0.32 0.50 112.27 75.1 112.63 79.8	
0.35 0.50 112.41 75.9 112.52 78.6	
0.38 0.50 112.43 76.6 112.36 77.4	
0.41 0.50 112.29 77.6 112.26 78.3	
0.45 0.50 112.23 78.4 112.25 78.5	
0.48 0.50 112.18 78.2 112.28 78.8	
0.51 0.50 112.12 79.1 112.12 79.1	
0.54 0.50 112.25 79.4 112.21 79.4	
0.57 0.50 112.20 80.4 112.29 81.2	
0.61 0.50 112.21 81.1 112.32 82.3	
0.64 0.50 112.93 81.3 112.91 83.1	
0.67 0.50 112.77 82.7 113.03 84.0	

General Information:	0.77 0.50 112.28 191.2 105.06 308.9
	0.80 0.50 109.50 119.0 104.26 308.6
Source Plane data = Planes 1 and 2	0.83 0.50 109.84 146.1 103.79 309.7
Exit Plane data = Planes 3 and 4	0.86 0.50 110.21 174.8 103.31 310.9
	0.89 0.50 110.61 205.2 102.81 312.2
Plane locations (w. r. t. streamwise location of liner x = 0.0)	0.93 0.50 111.04 237.2 102.30 313.5
plane 1: -7.75 in.	0.96 0.50 111.50 270.9 101.78 314.9
Plane 3: +16.0	0.99 0.50 111.99 306.2 101.24 316.3
Planes 2 and 4 are 0.3 in. behind planes 1 and 3, respectively.	Centerline Probe data
L = 11.0 in.	x/L spl phase
w = 4.7 in.	-0.89 107.4 80.5
h = 2.0 in.	-0.84 112.2 53.2
Hardwall	-0.80 114.6 43.3
M = 0.2	-0.75 114.9 37.6
T = 46 F	-0.70 113.6 31.7
	-0.66 110.0 17.0
	-0.61 105.9 329.4
	-0.57 109.4 275.0
2000 Hz	-0.52 113.0 256.5
source plane data	-0.48 114.7 249.6
y/w z/h spl phase spl phase	-0.43 114.3 244.2
0.03 0.50 113.03 41.3 113.30 18.8	-0.39 112.0 236.4
0.06 0.50 112.88 37.9 113.08 16.5	-0.34 107.0 209.2
0.10 0.50 112.86 35.5 113.10 16.9	-0.30 106.3 139.5
0.13 0.50 112.96 33.9 113.08 18.7	-0.25 111.5 109.3
0.16 0.50 112.93 32.3 113.09 19.7	-0.20 114.1 100.4
0.19 0.50 112.87 31.1 113.09 19.8	-0.16 114.7 96.1
0.22 0.50 112.98 29.4 113.11 21.4	-0.11 113.5 91.3
0.26 0.50 112.95 29.0 113.17 22.0	-0.07 110.0 79.0
0.29 0.50 113.02 29.3 113.17 22.9	-0.02 104.7 27.9
0.32 0.50 113.02 28.2 113.23 23.8	0.02 109.1 329.6
0.35 0.50 113.17 28.5 113.28 25.8	0.07 113.1 314.1
0.38 0.50 113.37 29.0 113.37 26.3	0.11 114.7 308.4
0.41 0.50 113.36 29.0 113.36 27.4	0.16 114.3 305.5
0.45 0.50 113.53 29.7 113.44 29.0	0.20 111.9 297.7
0.48 0.50 113.47 30.8 113.54 30.4	0.25 106.7 270.0
0.51 0.50 113.61 31.7 113.61 31.7	0.30 106.6 198.4
0.54 0.50 113.76 32.2 113.72 32.7	0.34 111.5 171.7
0.57 0.50 113.76 33.4 113.86 34.0	0.39 114.1 163.8
0.61 0.50 113.87 34.1 113.97 35.1	0.43 114.6 159.8
0.64 0.50 114.16 34.3 114.13 36.8	0.48 113.2 155.1
0.67 0.50 114.28 35.1 114.19 37.3	0.52 109.4 140.1
0.70 0.50 114.40 36.3 114.28 38.7	0.57 104.1 84.4
0.73 0.50 114.42 34.2 114.37 39.3	0.61 109.4 29.4
0.77 0.50 114.47 34.5 114.41 39.7	0.66 113.0 17.2
0.80 0.50 114.78 39.6 114.69 42.5	0.70 114.5 12.6
0.83 0.50 114.94 41.4 114.84 43.9	0.75 114.0 8.9
0.86 0.50 115.12 43.2 115.00 45.3	0.80 111.3 1.0
0.89 0.50 115.30 45.2 115.17 46.7	0.84 105.8 331.6
0.93 0.50 115.48 47.3 115.35 48.2	0.89 106.6 260.8
0.96 0.50 115.68 49.6 115.53 49.7	0.93 111.9 234.0
0.99 0.50 115.88 52.0 115.72 51.2	0.98 114.1 228.0
Exit Plane Data	1.02 114.4 224.6
X3 Plane X4 Plane	1.07 112.6 219.4
y/w z/h spl phase spl phase	1.11 107.8 204.7
0.03 0.50 109.99 296.7 111.46 304.0	1.16 103.2 133.1
0.06 0.50 109.84 293.5 111.11 304.4	1.20 109.7 87.3
0.10 0.50 109.42 294.4 110.82 303.8	1.25 113.4 77.3
0.13 0.50 109.54 295.1 110.75 303.8	1.30 114.5 73.7
0.16 0.50 109.45 293.4 110.71 301.7	1.34 113.6 72.6
0.19 0.50 109.25 293.5 110.54 299.1	1.39 110.3 64.5
0.22 0.50 109.20 292.0 110.62 300.6	1.43 103.6 19.5
0.26 0.50 109.07 293.4 110.38 298.0	1.48 107.6 304.4
0.29 0.50 108.90 296.6 110.19 303.9	1.52 112.6 282.6
0.32 0.50 108.87 297.0 110.18 304.8	
0.35 0.50 108.62 295.8 109.62 301.3	
0.38 0.50 108.44 299.1 109.40 299.1	
0.41 0.50 108.00 300.2 108.90 298.0	
0.45 0.50 107.89 300.5 108.40 304.3	
0.48 0.50 107.97 302.1 108.08 300.4	
0.51 0.50 107.55 304.4 107.55 304.4	
0.54 0.50 107.51 305.8 107.08 301.7	
0.57 0.50 107.42 309.4 106.48 304.7	
0.61 0.50 107.23 310.1 106.44 306.0	
0.64 0.50 107.77 310.8 106.25 302.8	
0.67 0.50 106.87 311.3 106.34 301.0	
0.70 0.50 104.58 300.9 105.71 303.2	
0.73 0.50 111.60 192.4 105.27 308.9	

General Information: 0.73 0.50 120.43 224.5 115.32 245.1
 0.77 0.50 120.45 223.1 115.31 244.8
 Source Plane data = Planes 1 and 2 0.80 0.50 120.91 223.4 116.10 240.8
 Exit Plane data = Planes 3 and 4 0.83 0.50 121.89 219.4 116.42 239.1
 0.86 0.50 122.92 215.2 116.76 237.4
 Plane locations (w. r. t. streamwise location of 0.89 0.50 124.00 211.0 117.12 235.7
 liner x = 0.0) 0.93 0.50 125.13 206.7 117.50 234.0
 plane 1: -7.75 in. 0.96 0.50 126.30 202.3 117.91 232.3
 Plane 3: +16.0 0.99 0.50 127.53 197.8 118.33 230.6

Planes 2 and 4 are 0.3 in. behind planes 1 and 3, respectively.
 L = 11.0 in.
 w = 4.7 in.
 h = 2.0 in.

Hardwall
 M = 0.2
 T = 46 F
 2500 Hz

source plane data
 y/w z/h spl phase spl phase
 0.03 0.50 108.48 245.3 109.06 221.8
 0.06 0.50 108.21 242.9 107.46 210.1
 0.10 0.50 108.45 240.6 107.58 210.7
 0.13 0.50 108.23 237.2 107.95 220.2
 0.16 0.50 108.47 234.4 108.25 221.0
 0.19 0.50 108.57 232.4 108.20 218.5
 0.22 0.50 108.80 229.8 108.38 216.5
 0.26 0.50 108.73 226.3 108.51 216.9
 0.29 0.50 108.83 223.4 108.69 215.8
 0.32 0.50 108.83 221.4 108.97 213.6
 0.35 0.50 108.88 218.0 108.78 213.0
 0.38 0.50 109.02 214.9 109.19 211.3
 0.41 0.50 109.17 212.2 109.35 209.5
 0.45 0.50 109.44 209.7 109.26 207.4
 0.48 0.50 109.52 208.0 109.73 206.8
 0.51 0.50 109.82 207.1 109.82 207.1
 0.54 0.50 110.07 206.4 110.12 207.7
 0.57 0.50 110.35 205.4 110.25 205.2
 0.61 0.50 110.25 202.4 110.65 202.6
 0.64 0.50 110.37 197.0 110.97 202.4
 0.67 0.50 110.54 195.3 111.14 199.8
 0.70 0.50 110.52 194.4 111.38 199.7
 0.73 0.50 110.71 191.0 111.41 196.6
 0.77 0.50 110.58 187.3 111.59 195.2
 0.80 0.50 111.10 187.4 112.17 192.9
 0.83 0.50 111.28 185.4 112.48 190.8
 0.86 0.50 111.46 183.5 112.81 188.7
 0.89 0.50 111.65 181.6 113.15 186.5
 0.93 0.50 111.85 179.7 113.50 184.2
 0.96 0.50 112.05 177.9 113.86 181.8
 0.99 0.50 112.25 176.1 114.23 179.4

Centerline Probe data
 x/L spl phase
 -0.89 113.8 320.6
 -0.84 114.8 304.2
 -0.80 113.5 287.8
 -0.75 110.3 259.4
 -0.70 109.8 207.1
 -0.66 113.3 172.5
 -0.61 114.9 157.1
 -0.57 114.3 145.2
 -0.52 111.5 123.2
 -0.48 108.5 72.5
 -0.43 111.8 26.2
 -0.39 114.0 7.4
 -0.34 113.8 355.2
 -0.30 110.8 336.2
 -0.25 107.7 280.8
 -0.20 111.9 233.2
 -0.16 114.7 217.4
 -0.11 114.9 207.5
 -0.07 112.7 195.2
 -0.02 108.6 159.5
 0.02 110.3 98.5
 0.07 113.7 74.2
 0.11 114.3 61.4
 0.16 112.5 48.7
 0.20 108.4 15.0
 0.25 109.4 313.4
 0.30 113.3 287.2
 0.34 114.3 277.2
 0.39 112.9 265.5
 0.43 109.1 240.3
 0.48 108.3 178.2
 0.52 112.4 144.8
 0.57 114.0 131.4
 0.61 112.8 119.1
 0.66 108.8 97.3
 0.70 107.2 29.0
 0.75 112.1 354.6
 0.80 114.1 342.5
 0.84 113.4 334.5
 0.89 109.9 318.0
 0.93 106.6 256.7
 0.98 111.1 210.7
 1.02 113.5 196.1
 1.07 113.2 185.4
 1.11 110.0 167.8
 1.16 106.2 111.5
 1.20 110.6 60.8
 1.25 113.3 44.3
 1.30 113.1 34.0
 1.34 110.1 19.0
 1.39 106.7 324.3
 1.43 111.3 270.4
 1.48 114.2 255.9
 1.52 114.0 237.2

Exit Plane Data
 X3 Plane X4 Plane
 y/w z/h spl phase spl phase
 0.03 0.50 111.53 294.6 114.89 286.5
 0.06 0.50 111.51 292.8 114.19 283.5
 0.10 0.50 111.10 293.5 114.19 280.2
 0.13 0.50 111.01 291.5 113.93 279.4
 0.16 0.50 111.32 287.8 113.86 277.7
 0.19 0.50 111.32 285.7 113.84 275.6
 0.22 0.50 111.52 280.8 113.92 274.5
 0.26 0.50 111.55 277.4 113.72 274.9
 0.29 0.50 111.62 276.3 113.59 274.7
 0.32 0.50 111.75 275.2 113.60 272.9
 0.35 0.50 112.52 269.6 113.58 269.3
 0.38 0.50 112.87 267.2 113.99 262.6
 0.41 0.50 113.19 264.0 113.78 261.3
 0.45 0.50 113.63 260.6 113.95 259.9
 0.48 0.50 113.83 258.1 114.00 257.3
 0.51 0.50 114.16 255.9 114.16 255.9
 0.54 0.50 114.53 253.3 114.33 251.0
 0.57 0.50 114.85 250.7 114.23 251.6
 0.61 0.50 115.32 248.8 114.35 252.1
 0.64 0.50 116.33 245.2 115.25 249.3
 0.67 0.50 116.76 243.6 115.57 249.0
 0.70 0.50 117.57 240.8 115.45 245.7

General Information:	0.64 0.50 111.60 188.5 111.09 189.8
	0.67 0.50 112.05 184.5 111.25 199.0
Source Plane data = Planes 1 and 2	0.70 0.50 112.32 187.2 111.64 192.6
Exit Plane data = Planes 3 and 4	0.73 0.50 112.15 186.7 110.97 190.4
	0.77 0.50 112.25 184.0 111.13 191.6
Plane locations (w. r. t. streamwise location of liner x = 0.0)	0.80 0.50 112.84 184.5 111.69 192.2
plane 1: -7.75 in.	0.83 0.50 113.18 183.4 111.97 191.9
Plane 3: +16.0	0.86 0.50 113.54 182.2 112.25 191.5
Planes 2 and 4 are 0.3 in. behind planes 1 and 3, respectively.	0.89 0.50 113.91 181.0 112.54 191.1
L = 11.0 in.	0.93 0.50 114.31 179.6 112.85 190.6
w = 4.7 in.	0.96 0.50 114.72 178.1 113.16 190.1
h = 2.0 in.	0.99 0.50 115.15 176.6 113.48 189.6
	Centerline Probe data
	x/L spl phase
	-0.89 107.3 115.7
	-0.84 107.3 125.3
Hard wall	-0.80 108.6 128.8
M = 0.3	-0.75 109.7 124.4
T = 45 F	-0.70 111.7 124.2
	-0.66 112.0 133.2
	-0.61 112.8 127.2
500 Hz	-0.57 113.0 127.6
	-0.52 112.7 124.6
source plane data	-0.48 113.4 120.1
y/w z/h spl phase spl phase	-0.43 112.6 116.5
0.03 0.50 113.59 135.9 112.62 133.6	-0.39 111.9 116.9
0.06 0.50 113.69 137.3 113.52 140.7	-0.34 110.6 111.8
0.10 0.50 112.76 131.4 113.13 130.8	-0.30 109.8 111.2
0.13 0.50 113.70 130.6 113.36 130.4	-0.25 108.1 113.1
0.16 0.50 113.64 131.5 113.59 124.8	-0.20 105.4 112.8
0.19 0.50 113.12 127.1 113.27 125.8	-0.16 103.1 120.9
0.22 0.50 112.51 126.3 113.17 130.6	-0.11 99.1 142.4
0.26 0.50 113.11 124.9 113.03 124.4	-0.07 98.0 143.3
0.29 0.50 113.07 129.3 111.95 118.0	-0.02 92.7 182.2
0.32 0.50 112.69 121.2 112.41 121.2	0.02 84.2 184.5
0.35 0.50 112.01 119.4 112.11 120.7	0.07 92.5 8.3
0.38 0.50 112.76 124.2 112.56 120.9	0.11 94.1 21.4
0.41 0.50 111.30 118.0 112.32 120.1	0.16 102.5 347.2
0.45 0.50 112.55 122.7 111.57 118.5	0.20 105.8 349.7
0.48 0.50 112.03 120.5 112.03 126.7	0.25 107.8 347.1
0.51 0.50 111.67 124.2 111.67 124.2	0.30 109.3 340.3
0.54 0.50 112.23 127.4 110.69 122.6	0.34 110.3 342.3
0.57 0.50 111.56 128.9 111.12 133.2	0.39 111.7 343.7
0.61 0.50 112.93 132.3 111.44 131.1	0.43 111.7 343.8
0.64 0.50 112.03 136.8 113.11 129.8	0.48 112.1 336.7
0.67 0.50 113.52 133.5 111.98 129.0	0.52 112.4 339.9
0.70 0.50 113.04 130.9 113.14 126.0	0.57 112.6 339.8
0.73 0.50 113.58 132.3 112.18 126.4	0.61 111.9 342.0
0.77 0.50 113.25 128.2 113.94 133.7	0.66 111.2 341.2
0.80 0.50 113.58 138.0 113.03 136.0	0.70 110.5 345.9
0.83 0.50 113.84 140.4 113.25 138.4	0.75 110.0 352.3
0.86 0.50 114.11 143.1 113.49 141.0	0.80 109.9 352.4
0.89 0.50 114.41 145.9 113.74 143.8	0.84 109.0 357.5
0.93 0.50 114.73 148.9 114.02 146.7	0.89 107.8 356.5
0.96 0.50 115.07 152.1 114.32 149.9	0.93 107.8 0.8
0.99 0.50 115.43 155.5 114.64 153.2	0.98 106.5 356.7
Exit Plane Data	1.02 104.6 356.0
X3 Plane X4 Plane	1.07 103.0 349.5
y/w z/h spl phase spl phase	1.11 94.9 327.1
0.03 0.50 109.43 175.8 106.59 182.4	1.16 94.0 269.3
0.06 0.50 109.96 196.7 107.70 201.2	1.20 97.0 212.7
0.10 0.50 109.70 191.9 108.56 194.5	1.25 101.4 192.6
0.13 0.50 110.14 183.9 109.34 195.3	1.30 105.4 191.6
0.16 0.50 109.84 185.7 108.68 188.7	1.34 105.8 185.7
0.19 0.50 109.79 186.1 108.18 192.7	1.39 108.4 190.1
0.22 0.50 109.55 185.0 107.83 190.9	1.43 108.5 190.1
0.26 0.50 110.30 184.8 108.20 192.0	1.48 109.6 193.7
0.29 0.50 109.36 190.9 108.55 194.1	1.52 109.8 198.7
0.32 0.50 109.80 191.2 108.01 195.4	
0.35 0.50 110.33 192.0 109.12 191.0	
0.38 0.50 110.01 191.8 108.50 192.3	
0.41 0.50 110.71 188.6 109.79 190.0	
0.45 0.50 109.72 185.5 109.27 196.3	
0.48 0.50 110.26 194.5 110.01 198.6	
0.51 0.50 109.64 193.7 109.64 193.7	
0.54 0.50 110.54 191.1 108.54 193.6	
0.57 0.50 110.66 189.9 109.31 190.8	
0.61 0.50 111.37 193.4 109.83 198.6	

General Information:	0.67 0.50 115.92 164.0 116.63 165.7
	0.70 0.50 115.67 163.5 115.74 164.1
Source Plane data = Planes 1 and 2	0.73 0.50 116.14 164.0 115.46 164.3
Exit Plane data = Planes 3 and 4	0.77 0.50 115.97 162.5 115.57 164.2
	0.80 0.50 116.25 168.7 116.02 168.8
Plane locations (w. r. t. streamwise location of liner x = 0.0)	0.83 0.50 116.50 170.0 116.22 170.0
plane 1: -7.75 in.	0.86 0.50 116.75 171.5 116.43 171.4
Plane 3: +16.0	0.89 0.50 117.01 173.1 116.65 172.9
Planes 2 and 4 are 0.3 in. behind planes 1 and 3, respectively.	0.93 0.50 117.28 174.9 116.86 174.6
L = 11.0 in.	0.96 0.50 117.56 176.7 117.09 176.4
w = 4.7 in.	0.99 0.50 117.85 178.8 117.32 178.3
h = 2.0 in.	Centerline Probe data
	x/L spl phase
	-0.89 113.0 353.1
	-0.84 113.6 353.3
	-0.80 114.2 352.5
	-0.75 113.7 352.5
Hard wall	-0.70 112.7 353.8
M = 0.3	-0.66 111.2 355.1
T = 45 F	-0.61 108.7 354.6
	-0.57 104.3 348.7
	-0.52 99.0 312.5
1000 Hz	-0.48 100.4 245.2
source plane data	-0.43 106.5 226.9
y/w z/h spl phase spl phase	-0.39 109.7 218.3
0.03 0.50 112.52 356.4 112.67 356.0	-0.34 111.7 214.4
0.06 0.50 111.96 357.9 112.73 358.5	-0.30 112.9 216.1
0.10 0.50 112.04 356.4 112.49 355.1	-0.25 113.5 215.9
0.13 0.50 111.66 356.2 112.42 353.7	-0.20 113.7 216.0
0.16 0.50 112.13 356.9 112.64 352.8	-0.16 113.1 217.9
0.19 0.50 112.22 353.5 112.77 355.4	-0.11 111.5 219.8
0.22 0.50 112.25 354.6 112.46 355.7	-0.07 109.7 219.0
0.26 0.50 112.32 355.1 112.67 352.1	-0.02 106.5 216.7
0.29 0.50 111.82 356.7 112.46 353.3	0.02 100.6 199.1
0.32 0.50 112.31 356.0 112.38 355.0	0.07 98.5 117.5
0.35 0.50 112.40 356.2 112.28 354.2	0.11 104.5 86.6
0.38 0.50 112.29 355.3 112.32 354.6	0.16 108.7 79.0
0.41 0.50 112.29 354.6 112.62 353.3	0.20 111.0 79.5
0.45 0.50 112.29 355.2 112.60 355.5	0.25 112.5 79.5
0.48 0.50 112.35 355.3 112.87 353.4	0.30 113.2 80.3
0.51 0.50 112.75 353.8 112.75 353.8	0.34 113.5 82.0
0.54 0.50 112.69 355.2 112.94 355.2	0.39 113.2 83.3
0.57 0.50 112.91 355.9 113.14 352.1	0.43 112.4 84.3
0.61 0.50 112.90 356.7 112.45 351.1	0.48 110.9 87.1
0.64 0.50 112.46 353.9 112.80 350.8	0.52 108.4 86.1
0.67 0.50 112.54 353.7 112.56 352.3	0.57 103.5 82.2
0.70 0.50 112.34 355.6 113.04 353.0	0.61 95.2 49.0
0.73 0.50 111.80 356.8 112.93 350.7	0.66 101.1 310.8
0.77 0.50 112.31 355.7 112.73 349.6	0.70 106.9 300.4
0.80 0.50 112.35 356.0 112.98 350.5	0.75 109.5 300.4
0.83 0.50 112.32 356.2 113.03 350.2	0.80 111.8 299.8
0.86 0.50 112.29 356.4 113.09 349.8	0.84 112.7 303.7
0.89 0.50 112.25 356.6 113.14 349.5	0.89 113.4 303.9
0.93 0.50 112.21 356.9 113.20 349.1	0.93 113.2 305.6
0.96 0.50 112.17 357.1 113.27 348.7	0.98 112.9 306.1
0.99 0.50 112.12 357.4 113.33 348.4	1.02 112.2 308.7
Exit Plane Data	1.07 110.2 311.5
X3 Plane X4 Plane	1.11 106.6 314.2
y/w z/h spl phase spl phase	1.16 100.5 307.5
0.03 0.50 111.13 202.8 110.54 208.0	1.20 92.6 174.0
0.06 0.50 113.43 166.9 113.22 170.3	1.25 104.0 154.6
0.10 0.50 113.47 165.9 113.21 171.2	1.30 108.7 153.6
0.13 0.50 113.26 167.9 113.26 169.9	1.34 111.2 158.0
0.16 0.50 113.94 164.7 113.34 171.7	1.39 112.7 159.6
0.19 0.50 113.53 166.6 113.73 169.1	1.43 113.5 163.3
0.22 0.50 113.47 165.8 113.39 167.8	1.48 113.9 165.8
0.26 0.50 113.80 164.7 113.77 168.5	1.52 113.4 165.6
0.29 0.50 113.64 162.4 113.50 170.1	
0.32 0.50 113.59 164.7 113.61 166.5	
0.35 0.50 113.58 165.1 113.46 169.1	
0.38 0.50 113.97 165.4 113.88 167.2	
0.41 0.50 113.52 164.6 113.79 166.5	
0.45 0.50 114.01 165.9 113.71 167.9	
0.48 0.50 113.98 164.6 113.58 165.2	
0.51 0.50 113.85 165.8 113.85 165.8	
0.54 0.50 114.19 168.8 113.74 168.6	
0.57 0.50 114.82 164.1 114.30 166.7	
0.61 0.50 114.32 165.8 114.74 166.1	
0.64 0.50 115.42 167.2 115.56 165.9	

General Information:	0.70 0.50 116.40 138.3 117.54 143.5
	0.73 0.50 116.78 137.8 117.10 145.2
Source Plane data = Planes 1 and 2	0.77 0.50 116.35 136.8 116.94 145.8
Exit Plane data = Planes 3 and 4	0.80 0.50 117.76 132.7 118.79 140.7
	0.83 0.50 118.22 130.5 119.37 139.4
Plane locations (w. r. t. streamwise location of liner x = 0.0)	0.86 0.50 118.71 128.2 119.99 137.9
plane 1: -7.75 in.	0.89 0.50 119.24 125.6 120.66 136.4
Plane 3: +16.0	0.93 0.50 119.80 122.8 121.36 134.6
Planes 2 and 4 are 0.3 in. behind planes 1 and 3, respectively.	0.96 0.50 120.40 119.8 122.11 132.8
L = 11.0 in.	0.99 0.50 121.03 116.6 122.90 130.8
w = 4.7 in.	
h = 2.0 in.	
	Centerline Probe data
	x/L spl phase
	-0.89 117.4 244.6
	-0.84 117.0 243.3
	-0.80 115.1 240.1
	-0.75 111.6 230.9
	-0.70 106.7 191.5
Hard wall	-0.66 109.3 131.2
M = 0.3	-0.61 113.9 112.7
T = 45 F	-0.57 116.6 107.6
	-0.52 117.7 107.4
1500 Hz	-0.48 117.8 108.5
source plane data	-0.43 116.5 106.8
y/w z/h spl phase spl phase	-0.39 113.9 101.4
0.03 0.50 110.60 226.6 112.26 254.3	-0.34 109.0 85.8
0.06 0.50 109.89 224.8 111.32 252.1	-0.30 105.6 22.6
0.10 0.50 109.54 224.1 110.72 248.8	-0.25 111.2 340.4
0.13 0.50 109.67 224.2 110.38 248.8	-0.20 115.3 332.7
0.16 0.50 109.54 223.0 110.95 248.8	-0.16 117.1 329.9
0.19 0.50 109.33 222.0 109.93 244.7	-0.11 117.6 331.1
0.22 0.50 109.53 217.6 110.03 241.0	-0.07 117.0 331.1
0.26 0.50 109.14 217.8 109.93 237.9	-0.02 114.7 330.3
0.29 0.50 108.86 215.9 109.88 236.1	0.02 110.2 321.4
0.32 0.50 108.63 214.2 109.51 231.8	0.07 103.6 273.3
0.35 0.50 108.06 209.3 108.95 229.9	0.11 108.9 206.5
0.38 0.50 107.84 206.8 108.49 224.8	0.16 114.2 195.0
0.41 0.50 107.70 202.3 107.72 215.3	0.20 116.6 192.9
0.45 0.50 107.42 200.4 107.80 211.9	0.25 117.5 193.5
0.48 0.50 107.34 198.4 107.75 207.8	0.30 117.0 193.9
0.51 0.50 106.69 191.5 106.69 191.5	0.34 115.2 195.1
0.54 0.50 106.33 188.5 106.59 184.3	0.39 111.4 190.4
0.57 0.50 105.58 182.8 106.29 175.9	0.43 104.3 164.1
0.61 0.50 105.27 180.7 107.18 167.6	0.48 106.6 74.6
0.64 0.50 104.93 171.4 107.67 155.1	0.52 113.1 57.2
0.67 0.50 104.14 163.7 108.45 145.6	0.57 116.0 55.8
0.70 0.50 104.28 159.0 108.80 141.2	0.61 117.4 57.9
0.73 0.50 104.22 152.6 109.36 136.8	0.66 117.4 59.8
0.77 0.50 104.34 142.8 109.79 131.3	0.70 116.0 58.9
0.80 0.50 103.15 138.1 109.29 110.9	0.75 113.0 55.4
0.83 0.50 102.70 130.5 109.66 99.4	0.80 107.0 36.9
0.86 0.50 102.24 122.6 110.08 87.3	0.84 104.3 315.8
0.89 0.50 101.77 114.5 110.54 74.9	0.89 111.8 284.6
0.93 0.50 101.28 106.0 111.04 61.9	0.93 115.6 279.1
0.96 0.50 100.78 97.1 111.58 48.6	0.98 117.4 279.8
0.99 0.50 100.27 88.0 112.16 34.7	1.02 117.8 281.4
Exit Plane Data	1.07 116.9 282.3
X3 Plane X4 Plane	1.11 114.2 281.6
y/w z/h spl phase spl phase	1.16 109.1 273.1
0.03 0.50 121.54 91.4 121.53 97.2	1.20 101.6 204.3
0.06 0.50 115.42 142.6 115.13 148.5	1.25 109.9 142.6
0.10 0.50 115.42 141.7 115.13 147.9	1.30 114.9 137.4
0.13 0.50 115.20 141.5 115.20 145.6	1.34 117.1 138.7
0.16 0.50 115.17 139.7 115.09 144.7	1.39 117.9 141.6
0.19 0.50 115.25 140.5 115.10 144.0	1.43 117.3 143.7
0.22 0.50 115.14 139.6 115.14 143.5	1.48 115.4 144.8
0.26 0.50 115.23 140.2 115.16 143.3	1.52 111.4 138.2
0.29 0.50 115.16 138.1 115.26 142.7	
0.32 0.50 115.24 138.7 115.20 142.1	
0.35 0.50 115.33 137.9 115.14 144.5	
0.38 0.50 115.36 137.3 115.27 142.4	
0.41 0.50 115.38 138.6 115.47 139.8	
0.45 0.50 115.33 140.8 115.33 143.9	
0.48 0.50 115.43 141.8 115.46 145.0	
0.51 0.50 115.35 144.8 115.35 144.8	
0.54 0.50 115.88 147.2 115.55 144.4	
0.57 0.50 115.69 140.7 116.08 145.6	
0.61 0.50 115.85 140.3 116.25 147.3	
0.64 0.50 116.47 140.0 117.07 143.8	
0.67 0.50 116.65 139.6 118.16 144.1	

General Information: 0.70 0.50 102.03 48.7 103.09 57.8
 0.73 0.50 101.32 43.8 102.98 64.3
 Source Plane data = Planes 1 and 2 0.77 0.50 100.59 41.5 102.54 68.8
 Exit Plane data = Planes 3 and 4 0.80 0.50 102.34 47.4 104.77 78.4
 0.83 0.50 102.55 47.0 105.43 82.3
 Plane locations (w. r. t. streamwise location of
 liner x = 0.0) 0.86 0.50 102.76 46.5 106.14 86.4
 0.89 0.50 102.97 45.8 106.89 90.5
 plane 1: -7.75 in. 0.93 0.50 103.18 45.0 107.69 94.7
 Plane 3: +16.0 0.96 0.50 103.38 44.0 108.53 99.0
 Planes 2 and 4 are 0.3 in. behind planes 1 and 3,
 respectively. 0.99 0.50 103.59 42.9 109.42 103.3

L = 11.0 in.
 w = 4.7 in.
 h = 2.0 in.

Hard wall
 M = 0.3
 T = 45 F

2000 Hz
 source plane data

y/w	z/h	spl	phase	spl	phase
0.03	0.50	110.05	20.0	109.71	14.5
0.06	0.50	110.33	15.5	110.09	13.3
0.10	0.50	110.40	14.8	110.70	11.4
0.13	0.50	110.69	12.3	110.44	9.6
0.16	0.50	110.36	16.9	110.40	10.5
0.19	0.50	110.39	17.2	110.68	11.0
0.22	0.50	110.04	18.6	110.93	10.6
0.26	0.50	110.40	16.4	110.69	10.8
0.29	0.50	110.17	17.5	110.63	12.5
0.32	0.50	110.82	13.1	110.80	13.3
0.35	0.50	110.29	16.8	111.10	14.7
0.38	0.50	110.57	16.9	110.75	15.8
0.41	0.50	111.07	17.3	111.22	17.7
0.45	0.50	111.12	17.2	111.44	16.7
0.48	0.50	111.10	17.8	111.53	17.6
0.51	0.50	112.10	17.0	112.10	17.0
0.54	0.50	112.27	15.3	112.23	18.1
0.57	0.50	112.86	14.5	112.56	17.3
0.61	0.50	112.97	16.2	112.58	19.3
0.64	0.50	113.39	15.8	113.21	19.3
0.67	0.50	114.48	15.5	113.83	18.1
0.70	0.50	115.03	14.1	113.93	20.4
0.73	0.50	115.04	14.2	114.09	21.1
0.77	0.50	115.25	12.8	114.22	20.4
0.80	0.50	116.30	13.4	114.83	22.5
0.83	0.50	116.95	13.0	115.22	23.3
0.86	0.50	117.63	12.5	115.63	24.1
0.89	0.50	118.35	12.1	116.06	24.9
0.93	0.50	119.10	11.6	116.50	25.8
0.96	0.50	119.88	11.0	116.96	26.6
0.99	0.50	120.70	10.5	117.44	27.5

Centerline Probe data

x/L	spl	phase
-0.89	112.4	147.0
-0.84	108.9	135.3
-0.80	103.8	87.4
-0.75	108.3	30.6
-0.70	112.1	17.0
-0.66	113.5	13.9
-0.61	112.9	10.0
-0.57	110.1	4.2
-0.52	104.8	333.1
-0.48	105.6	266.6
-0.43	110.8	241.5
-0.39	113.0	236.9
-0.34	113.0	234.4
-0.30	110.5	230.1
-0.25	105.1	205.9
-0.20	104.7	133.1
-0.16	110.4	105.2
-0.11	113.0	101.4
-0.07	113.4	99.6
-0.02	111.6	97.6
0.02	106.5	83.6
0.07	102.7	10.3
0.11	109.3	329.8
0.16	112.6	323.7
0.20	113.6	321.1
0.25	111.9	320.2
0.30	107.9	310.1
0.34	101.6	259.9
0.39	107.5	197.3
0.43	112.0	188.5
0.48	113.4	187.2
0.52	112.6	186.4
0.57	109.7	183.7
0.61	102.4	150.8
0.66	105.9	67.8
0.70	111.2	52.0
0.75	113.4	49.2
0.80	113.2	49.7
0.84	110.3	47.5
0.89	103.8	24.1
0.93	104.0	296.6
0.98	110.4	274.9
1.02	113.1	272.6
1.07	113.2	271.7
1.11	110.9	270.3
1.16	105.4	255.8
1.20	102.1	167.0
1.25	109.5	136.9
1.30	112.7	132.6
1.34	113.5	133.9
1.39	111.7	133.9
1.43	107.3	126.0
1.48	100.6	51.7
1.52	108.2	5.7

Exit Plane Data

y/w	z/h	X3 Plane		X4 Plane	
		spl	phase	spl	phase
0.03	0.50	97.07	8.0	101.89	8.0
0.06	0.50	98.13	21.1	102.82	22.5
0.10	0.50	98.02	20.3	101.94	15.4
0.13	0.50	97.72	22.1	101.57	19.5
0.16	0.50	97.87	19.8	100.71	18.6
0.19	0.50	98.25	22.5	100.66	14.2
0.22	0.50	98.23	24.6	101.10	15.4
0.26	0.50	98.06	28.1	100.26	16.7
0.29	0.50	98.20	29.5	100.05	23.8
0.32	0.50	98.69	32.5	99.88	24.5
0.35	0.50	99.09	31.2	99.64	31.4
0.38	0.50	99.04	33.1	99.22	28.8
0.41	0.50	99.52	36.4	99.93	25.5
0.45	0.50	100.11	41.7	100.21	42.2
0.48	0.50	100.19	43.8	100.97	52.3
0.51	0.50	100.64	51.7	100.64	51.7
0.54	0.50	101.85	56.5	101.29	62.3
0.57	0.50	101.08	47.9	102.02	59.2
0.61	0.50	101.40	49.5	102.84	71.6
0.64	0.50	102.02	47.6	102.44	61.1
0.67	0.50	102.51	46.8	104.41	65.6

General Information:	0.70 0.50 115.80 326.0 113.69 358.7
	0.73 0.50 117.24 318.3 113.86 3.3
Source Plane data = Planes 1 and 2	0.77 0.50 117.95 310.2 113.95 0.9
Exit Plane data = Planes 3 and 4	0.80 0.50 118.83 300.6 114.65 296.4
	0.83 0.50 120.12 292.1 115.14 289.5
Plane locations (w. r. t. streamwise location of liner x = 0.0)	0.86 0.50 121.50 283.4 115.64 282.6
plane 1: -7.75 in.	0.89 0.50 122.96 274.6 116.14 275.5
Plane 3: +16.0	0.93 0.50 124.51 265.5 116.64 268.3
Planes 2 and 4 are 0.3 in. behind planes 1 and 3, respectively.	0.96 0.50 126.14 256.2 117.13 260.9
L = 11.0 in.	0.99 0.50 127.86 246.7 117.63 253.5
w = 4.7 in.	Centerline Probe data
h = 2.0 in.	x/L spl phase
	-0.89 107.5 49.3
	-0.84 104.8 348.1
	-0.80 109.3 306.0
	-0.75 111.8 295.1
Hard wall	-0.70 111.4 285.8
M = 0.3	-0.66 107.6 268.0
T = 45 F	-0.61 104.6 210.7
	-0.57 109.6 170.2
2500 Hz	-0.52 111.7 157.9
source plane data	-0.48 111.3 150.6
y/w z/h spl phase spl phase	-0.43 107.8 136.9
0.03 0.50 107.38 280.1 109.66 288.2	-0.39 103.4 82.5
0.06 0.50 107.02 280.2 109.39 285.6	-0.34 108.1 33.7
0.10 0.50 107.92 283.5 109.18 282.9	-0.30 110.5 18.8
0.13 0.50 107.73 282.9 109.22 284.5	-0.25 110.3 9.0
0.16 0.50 107.44 280.6 109.38 281.6	-0.20 107.0 350.3
0.19 0.50 107.77 279.0 109.60 281.6	-0.16 105.3 293.8
0.22 0.50 107.92 278.8 109.62 282.4	-0.11 109.6 258.5
0.26 0.50 107.91 282.5 109.70 282.3	-0.07 111.6 249.2
0.29 0.50 108.53 283.5 109.92 282.4	-0.02 110.9 241.7
0.32 0.50 109.48 282.6 109.76 283.0	0.02 107.0 228.1
0.35 0.50 109.69 285.3 110.15 283.0	0.07 102.0 161.8
0.38 0.50 110.00 285.7 110.30 283.7	0.11 108.1 115.0
0.41 0.50 110.15 285.6 110.52 284.3	0.16 110.9 103.7
0.45 0.50 110.50 286.7 110.79 285.4	0.20 110.6 97.6
0.48 0.50 111.07 285.0 111.02 284.7	0.25 107.2 83.3
0.51 0.50 111.36 285.8 111.36 285.8	0.30 103.3 24.7
0.54 0.50 111.96 287.1 111.74 286.1	0.34 108.1 342.6
0.57 0.50 112.25 288.3 112.03 288.7	0.39 110.7 330.6
0.61 0.50 112.32 289.2 112.03 288.6	0.43 110.3 323.6
0.64 0.50 112.90 288.5 112.40 287.9	0.48 106.9 311.4
0.67 0.50 113.26 289.9 112.49 289.0	0.52 102.8 255.5
0.70 0.50 113.11 290.9 112.73 290.0	0.57 107.9 206.5
0.73 0.50 113.37 291.6 112.44 289.9	0.61 110.3 195.5
0.77 0.50 113.55 290.4 112.68 289.8	0.66 109.6 186.7
0.80 0.50 114.46 292.6 113.43 293.0	0.70 106.0 169.1
0.83 0.50 114.86 293.3 113.73 294.2	0.75 103.6 105.0
0.86 0.50 115.26 294.1 114.03 295.5	0.80 108.8 66.7
0.89 0.50 115.67 294.9 114.35 296.9	0.84 110.9 58.5
0.93 0.50 116.09 295.7 114.68 298.4	0.89 110.1 51.6
0.96 0.50 116.51 296.6 115.01 299.9	0.93 106.1 35.0
0.99 0.50 116.94 297.5 115.36 301.5	0.98 102.1 325.8
Exit Plane Data	1.02 108.4 286.6
X3 Plane X4 Plane	1.07 110.6 277.4
y/w z/h spl phase spl phase	1.11 110.2 269.5
0.03 0.50 109.90 91.7 100.20 78.2	1.16 106.1 252.3
0.06 0.50 113.01 75.8 104.14 65.0	1.20 103.3 189.2
0.10 0.50 112.61 72.5 103.46 53.4	1.25 108.2 150.7
0.13 0.50 111.66 69.6 104.53 44.8	1.30 110.2 139.7
0.16 0.50 111.50 65.5 105.38 34.5	1.34 109.3 131.0
0.19 0.50 111.35 66.5 105.71 32.9	1.39 105.4 106.4
0.22 0.50 110.97 62.4 106.11 30.8	1.43 104.9 40.7
0.26 0.50 110.48 58.0 106.72 28.6	1.48 109.5 13.7
0.29 0.50 110.43 49.3 106.58 27.3	1.52 110.7 2.3
0.32 0.50 109.80 43.7 107.41 23.7	
0.35 0.50 109.80 43.7 107.44 19.8	
0.38 0.50 109.61 30.6 107.98 19.2	
0.41 0.50 109.50 23.3 109.27 16.8	
0.45 0.50 109.51 20.7 108.66 16.2	
0.48 0.50 109.62 9.5 108.77 14.7	
0.51 0.50 109.46 13.7 109.46 13.7	
0.54 0.50 110.42 8.4 109.86 14.0	
0.57 0.50 112.17 349.6 110.31 11.1	
0.61 0.50 112.58 343.8 111.00 13.1	
0.64 0.50 113.91 337.1 112.77 4.8	
0.67 0.50 114.73 331.6 113.77 5.6	

Plane locations (w. r. t. streamwise location of
liner $x = 0.0$)
plane 1: -7.5 in.
Plane 3: +16.0 in.
Planes 2 and 4 are 0.3 in. behind planes 1 and 3,
respectively.
 $L = 11.0$ in.
 $w = 4.7$ in.
 $h = 2.0$ in.

Plane locations (w. r. t. streamwise location of
 liner $x = 0.0$)
 plane 1: -7.5 in.
 Plane 3: +16.0 in.
 Planes 2 and 4 are 0.3 in. behind planes 1 and 3,
 respectively.
 $L = 11.0$ in.
 $w = 4.7$ in.
 $h = 2.0$ in.

0.73 0.50 108.13 12.4 108.64 11.4
 0.77 0.50 108.13 12.6 108.65 11.5
 0.80 0.50 108.12 12.8 108.65 11.5
 0.83 0.50 108.10 13.0 108.65 11.6
 0.86 0.50 108.09 13.2 108.65 11.6
 0.89 0.50 108.07 13.4 108.65 11.7
 0.93 0.50 108.06 13.6 108.66 11.8
 0.96 0.50 108.05 13.9 108.66 11.9
 0.99 0.50 108.03 14.1 108.66 11.9

0.66 105.3 206.3
 0.68 105.4 203.3
 0.70 105.4 200.5
 0.73 105.4 198.0
 0.75 105.4 195.6
 0.77 105.2 193.4
 0.80 105.0 191.3
 0.82 104.7 189.3
 0.84 104.4 187.3

Centerline Probe data

x/L spl phase

-0.86 112.0 108.2
 -0.84 112.2 105.4
 -0.82 112.4 102.7
 -0.80 112.6 100.1
 -0.77 112.7 97.6
 -0.75 112.8 95.2
 -0.73 113.0 93.1
 -0.70 113.1 90.9
 -0.68 113.2 88.7
 -0.66 113.2 86.5
 -0.64 113.3 84.4
 -0.61 113.3 82.3
 -0.59 113.4 80.3
 -0.57 113.4 78.2
 -0.55 113.4 76.2
 -0.52 113.4 74.2
 -0.50 113.4 72.2
 -0.48 113.4 70.0
 -0.45 113.3 68.1
 -0.43 113.3 66.0
 -0.41 113.2 63.9
 -0.39 113.1 61.8
 -0.36 113.0 59.7
 -0.34 112.9 57.5
 -0.32 112.7 55.2
 -0.30 112.6 52.9
 -0.27 112.4 50.4
 -0.25 112.2 47.9
 -0.23 112.0 45.4
 -0.20 111.8 42.8
 -0.18 111.6 39.9
 -0.16 111.3 37.0
 -0.14 111.1 34.0
 -0.11 110.8 30.7
 -0.09 110.6 27.3
 -0.07 110.2 23.7
 -0.05 109.9 20.0
 -0.02 109.6 16.2
 0.00 109.3 12.1
 0.02 109.0 8.0
 0.05 108.7 3.7

0.86 104.0 185.4
 0.89 103.4 183.4
 0.91 102.8 181.3
 0.93 102.0 179.1
 0.95 101.1 176.4
 0.98 100.0 173.4
 1.00 98.6 169.4
 1.02 97.1 164.1
 1.05 95.1 156.2
 1.07 92.8 143.3
 1.09 90.7 121.2
 1.11 90.2 89.9
 1.14 91.9 62.6
 1.16 94.2 46.0
 1.18 96.4 36.0
 1.20 98.3 29.9
 1.23 99.9 25.6
 1.25 101.3 22.6
 1.27 102.4 20.4
 1.30 103.4 18.5
 1.32 104.3 17.1
 1.34 105.1 15.8
 1.36 105.8 14.8
 1.39 106.4 13.9
 1.41 106.9 13.2
 1.43 107.4 12.5
 1.45 107.9 12.0
 1.48 108.3 11.3
 1.50 108.7 10.9
 1.52 109.0 10.5
 1.55 109.3 10.1

Liner
 $M = 0.0$
 $T = 78$ F

500 Hz

source plane data

y/w	z/h	spl phase	spl phase
0.00	0.50	113.09	88.0 112.90 85.3
0.03	0.50	113.05	88.8 113.01 85.8
0.06	0.50	113.04	88.7 113.01 86.0
0.10	0.50	113.05	88.7 113.02 86.1
0.13	0.50	113.05	88.6 113.02 86.1
0.16	0.50	113.06	88.6 113.02 86.1
0.19	0.50	113.05	88.5 113.03 86.0
0.22	0.50	113.05	88.5 113.03 86.0
0.26	0.50	113.06	88.4 113.05 86.0
0.29	0.50	113.05	88.4 113.06 85.9
0.32	0.50	113.05	88.3 113.08 85.9
0.35	0.50	113.10	88.5 113.10 85.9
0.38	0.50	113.13	88.6 113.14 86.0
0.41	0.50	113.14	88.6 113.18 86.3
0.45	0.50	113.15	88.6 113.21 86.4
0.48	0.50	113.16	88.7 113.24 86.5
0.51	0.50	113.17	88.7 113.25 86.6
0.54	0.50	113.19	89.0 113.42 87.4
0.57	0.50	113.19	89.1 113.46 87.6
0.61	0.50	113.19	89.1 113.48 87.6
0.64	0.50	113.21	89.1 113.50 87.5
0.67	0.50	113.21	89.0 113.50 87.5
0.70	0.50	113.20	89.2 113.50 87.5
0.73	0.50	113.20	89.1 113.49 87.5
0.77	0.50	113.25	89.3 113.63 88.0
0.80	0.50	113.27	89.4 113.69 88.2
0.83	0.50	113.28	89.5 113.74 88.4
0.86	0.50	113.30	89.6 113.79 88.6
0.89	0.50	113.32	89.7 113.85 88.8
0.93	0.50	113.33	89.8 113.91 89.0
0.96	0.50	113.35	90.0 113.97 89.3
0.99	0.50	113.37	90.1 114.03 89.5

Exit Plane Data

y/w	z/h	X3 Plane		X4 Plane	
		spl phase	spl phase	spl phase	spl phase
0.00	0.50	108.55	11.8	108.81	10.8
0.03	0.50	108.50	11.8	108.78	10.9
0.06	0.50	108.44	11.7	108.77	11.0
0.10	0.50	108.44	11.7	108.78	11.1
0.13	0.50	108.42	11.6	108.76	11.1
0.16	0.50	108.41	11.6	108.76	11.0
0.19	0.50	108.41	11.6	108.76	11.2
0.22	0.50	108.38	11.5	108.74	11.1
0.26	0.50	108.36	11.5	108.75	11.1
0.29	0.50	108.34	11.5	108.74	11.0
0.32	0.50	108.34	11.5	108.73	11.0
0.35	0.50	108.30	11.3	108.70	11.0
0.38	0.50	108.31	11.3	108.69	11.0
0.41	0.50	108.29	11.3	108.66	10.8
0.45	0.50	108.28	11.2	108.67	10.9
0.48	0.50	108.29	11.3	108.65	10.9
0.51	0.50	108.26	11.5	108.65	11.0
0.54	0.50	108.27	12.0	108.66	11.1
0.57	0.50	108.24	12.2	108.65	11.3
0.61	0.50	108.18	12.1	108.70	11.3
0.64	0.50	108.18	12.1	108.68	11.3
0.67	0.50	108.16	12.2	108.67	11.3
0.70	0.50	108.15	12.3	108.66	11.4

0.07 108.3 359.3
 0.09 108.0 354.8
 0.11 107.6 350.1
 0.14 107.2 345.3
 0.16 106.8 340.4
 0.18 106.4 335.2
 0.20 105.9 329.7
 0.23 105.5 323.9
 0.25 105.1 317.8
 0.27 104.7 311.4
 0.30 104.3 304.5
 0.32 103.9 297.3
 0.34 103.6 289.7
 0.36 103.4 281.9
 0.39 103.3 274.0
 0.41 103.2 266.1
 0.43 103.3 258.4
 0.45 103.4 251.1
 0.48 103.6 244.2
 0.50 103.8 237.8
 0.52 104.1 231.8
 0.55 104.3 226.5
 0.57 104.6 221.6
 0.59 104.8 217.3
 0.61 105.0 213.2
 0.64 105.2 209.6

Plane locations (w. r. t. streamwise location of
 liner x = 0.0)
 plane 1: -7.5 in.
 Plane 3: +16.0 in.
 Planes 2 and 4 are 0.3 in. behind planes 1 and 3,
 respectively.
 L = 11.0 in.
 w = 4.7 in.
 h = 2.0 in.

Liner
 M = 0.0
 T = 78 F
 1000 Hz

source plane data

y/w	z/h	spl	phase	spl	phase
0.00	0.50	113.27	250.8	112.97	247.9
0.03	0.50	113.34	251.7	112.96	247.3
0.06	0.50	113.33	251.7	112.96	247.2
0.10	0.50	113.34	251.6	112.98	247.4
0.13	0.50	113.34	251.4	113.00	247.5
0.16	0.50	113.34	251.3	113.03	247.5
0.19	0.50	113.35	251.1	113.04	247.5
0.22	0.50	113.34	250.9	113.06	247.5
0.26	0.50	113.32	250.9	113.06	247.4
0.29	0.50	113.37	250.9	113.05	247.3
0.32	0.50	113.39	251.0	113.06	247.2
0.35	0.50	113.35	250.8	113.06	247.2
0.38	0.50	113.42	250.5	113.06	247.0
0.41	0.50	113.38	250.8	113.08	247.0
0.45	0.50	113.39	250.8	113.08	247.0
0.48	0.50	113.39	250.8	113.08	246.9
0.51	0.50	113.38	250.7	113.11	247.0
0.54	0.50	113.42	250.9	113.10	246.9
0.57	0.50	113.42	251.0	113.11	246.9
0.61	0.50	113.43	251.0	113.11	246.5
0.64	0.50	113.43	250.8	113.08	246.3
0.67	0.50	113.43	250.7	113.07	246.3
0.70	0.50	113.44	251.0	113.08	246.3
0.73	0.50	113.46	251.0	113.07	246.3
0.77	0.50	113.46	251.1	113.07	246.1
0.80	0.50	113.46	251.1	113.06	245.9
0.83	0.50	113.47	251.2	113.06	245.8
0.86	0.50	113.48	251.3	113.05	245.7
0.89	0.50	113.48	251.3	113.04	245.6
0.93	0.50	113.49	251.4	113.03	245.4
0.96	0.50	113.50	251.5	113.01	245.3
0.99	0.50	113.50	251.6	113.00	245.1

Exit Plane Data

		X3 Plane	X4 Plane		
y/w	z/h	spl phase	spl phase		
0.00	0.50	94.58	69.6	94.58	68.9
0.03	0.50	94.67	68.6	94.38	68.3
0.06	0.50	94.64	68.7	94.44	68.9
0.10	0.50	94.90	69.4	94.85	68.1
0.13	0.50	95.04	68.5	94.89	70.4
0.16	0.50	95.14	67.4	94.41	67.5
0.19	0.50	95.01	72.7	94.80	70.4
0.22	0.50	95.36	73.0	94.75	70.4
0.26	0.50	95.00	70.1	94.74	70.4
0.29	0.50	94.95	73.1	94.72	70.5
0.32	0.50	94.94	70.5	94.66	71.3
0.35	0.50	94.67	70.6	94.44	71.3
0.38	0.50	94.72	70.6	94.59	71.3
0.41	0.50	94.64	70.8	94.22	70.8
0.45	0.50	94.79	70.1	94.34	70.0
0.48	0.50	94.66	70.3	94.46	69.6
0.51	0.50	95.09	71.5	94.36	70.5
0.54	0.50	94.63	70.7	94.44	69.7
0.57	0.50	94.56	70.8	94.42	69.6
0.61	0.50	94.62	70.6	94.40	70.3
0.64	0.50	94.63	70.8	94.43	69.9
0.67	0.50	94.61	71.2	94.47	69.6
0.70	0.50	94.61	70.7	94.48	69.8
0.73	0.50	94.51	70.6	94.45	69.8
0.77	0.50	94.36	70.2	94.35	69.0

0.80	0.50	94.29	70.0	94.33	68.7
0.83	0.50	94.21	69.8	94.31	68.4
0.86	0.50	94.13	69.5	94.29	68.0
0.89	0.50	94.04	69.2	94.27	67.6
0.93	0.50	93.95	69.0	94.25	67.2
0.96	0.50	93.85	68.7	94.23	66.8
0.99	0.50	93.75	68.3	94.20	66.3

Centerline Probe data

x/L	spl	phase
-0.86	112.9	279.8
-0.84	113.3	275.7
-0.82	113.5	271.8
-0.80	113.7	268.2
-0.77	113.8	264.6
-0.75	113.8	261.3
-0.73	113.8	258.0
-0.70	113.6	254.5
-0.68	113.4	250.8
-0.66	113.1	246.9
-0.64	112.7	242.6
-0.61	112.2	237.9
-0.59	111.7	232.6
-0.57	111.1	226.5
-0.55	110.4	219.5
-0.52	109.8	211.5
-0.50	109.1	202.0
-0.48	108.6	191.2
-0.45	108.3	179.6
-0.43	108.3	167.6
-0.41	108.6	155.7
-0.39	109.0	144.9
-0.36	109.6	135.4
-0.34	110.2	127.0
-0.32	110.9	119.8
-0.30	111.4	113.8
-0.27	112.0	108.5
-0.25	112.4	103.8
-0.23	112.8	99.4
-0.20	113.1	95.5
-0.18	113.3	91.8
-0.16	113.5	88.2
-0.14	113.6	84.8
-0.11	113.6	81.4
-0.09	113.5	77.9
-0.07	113.3	74.4
-0.05	113.2	70.9
-0.02	112.9	67.3
0.00	112.6	63.6
0.02	112.3	59.8
0.05	111.9	55.9
0.07	111.6	51.9
0.09	111.1	47.8
0.11	110.7	43.7
0.14	110.3	39.4
0.16	109.8	35.1
0.18	109.4	30.8
0.20	108.9	26.4
0.23	108.4	21.9
0.25	107.9	17.3
0.27	107.4	12.6
0.30	106.9	7.9
0.32	106.5	3.1
0.34	106.0	358.1
0.36	105.5	353.1
0.39	105.1	348.0
0.41	104.6	342.8
0.43	104.2	337.7
0.45	103.8	332.4
0.48	103.4	327.2
0.50	103.0	321.9
0.52	102.7	316.7
0.55	102.4	311.6
0.57	102.1	306.7
0.59	101.8	302.0
0.61	101.5	297.3
0.64	101.3	293.0
0.66	101.0	288.9
0.68	100.7	284.9

0.70	100.3	281.0
0.73	100.0	277.4
0.75	99.7	274.3
0.77	99.3	271.2
0.80	98.9	268.2
0.82	98.4	265.4
0.84	97.9	262.8
0.86	97.4	260.4
0.89	96.8	258.0
0.91	96.1	255.7
0.93	95.4	253.5
0.95	94.5	251.0
0.98	93.6	248.9
1.00	92.4	246.2
1.02	91.1	243.3
1.05	89.5	239.5
1.07	87.6	234.0
1.09	85.1	225.5
1.11	81.9	210.1
1.14	79.1	177.8
1.16	79.8	135.6
1.18	83.0	109.8
1.20	85.7	97.2
1.23	87.9	90.6
1.25	89.6	86.6
1.27	90.9	83.7
1.30	92.0	81.3
1.32	92.7	79.0
1.34	93.4	77.1
1.36	93.9	75.5
1.39	94.2	74.3
1.41	94.5	73.2
1.43	94.7	72.1
1.45	94.7	71.1
1.48	94.7	70.3
1.50	94.5	69.6
1.52	94.2	68.4
1.55	93.8	67.2

Plane locations (w. r. t. streamwise location of
 liner $x = 0.0$)
 plane 1: -7.5 in.
 Plane 3: +16.0 in.
 Planes 2 and 4 are 0.3 in. behind planes 1 and 3,
 respectively.
 L = 11.0 in.
 w = 4.7 in.
 h = 2.0 in.

Liner
 M = 0.0
 T = 78 F

1500 Hz
 source plane data

y/w	z/h	spl	phase	spl	phase
0.00	0.50	114.02	41.5	114.22	33.9
0.03	0.50	113.89	44.7	114.28	32.7
0.06	0.50	113.92	45.1	114.28	33.5
0.10	0.50	113.96	45.4	114.27	34.6
0.13	0.50	114.02	46.4	114.27	36.0
0.16	0.50	114.09	47.4	114.30	37.3
0.19	0.50	114.17	48.6	114.33	38.8
0.22	0.50	114.23	50.2	114.36	40.4
0.26	0.50	114.30	52.1	114.41	42.2
0.29	0.50	114.40	54.0	114.45	43.8
0.32	0.50	114.51	56.2	114.53	45.9
0.35	0.50	114.69	58.6	114.62	48.1
0.38	0.50	114.75	60.6	114.73	49.7
0.41	0.50	114.92	62.9	114.82	52.1
0.45	0.50	115.09	64.9	114.98	54.2
0.48	0.50	115.26	67.0	115.09	56.0
0.51	0.50	115.44	68.9	115.24	58.2
0.54	0.50	115.64	71.2	115.35	60.4
0.57	0.50	115.81	73.0	115.50	62.1
0.61	0.50	116.09	74.9	115.70	63.1
0.64	0.50	116.24	75.9	115.78	64.2
0.67	0.50	116.42	77.5	115.90	65.6
0.70	0.50	116.60	79.4	116.00	66.9
0.73	0.50	116.79	80.6	116.15	68.4
0.77	0.50	117.14	84.6	116.43	72.0
0.80	0.50	117.40	86.8	116.62	74.0
0.83	0.50	117.67	89.1	116.83	76.1
0.86	0.50	117.96	91.4	117.03	78.1
0.89	0.50	118.25	93.7	117.25	80.2
0.93	0.50	118.55	96.1	117.48	82.3
0.96	0.50	118.86	98.5	117.71	84.4
0.99	0.50	119.18	101.0	117.95	86.5

Exit Plane Data

		X3 Plane		X4 Plane	
y/w	z/h	spl	phase	spl	phase
0.00	0.50	108.01	265.8	105.73	251.7
0.03	0.50	108.08	265.9	105.89	252.0
0.06	0.50	108.11	265.8	105.91	252.6
0.10	0.50	107.95	266.5	105.80	255.0
0.13	0.50	107.85	268.0	105.94	256.4
0.16	0.50	107.50	269.1	105.51	257.2
0.19	0.50	107.29	269.3	105.19	258.6
0.22	0.50	107.16	268.9	104.96	258.0
0.26	0.50	107.04	269.8	104.72	257.4
0.29	0.50	107.01	269.8	104.70	257.9
0.32	0.50	106.84	268.7	104.66	258.1
0.35	0.50	106.86	269.5	104.50	258.7
0.38	0.50	106.75	270.3	104.53	259.0
0.41	0.50	106.70	270.6	104.51	258.4
0.45	0.50	106.54	271.4	104.48	259.6
0.48	0.50	106.47	272.7	104.30	261.7
0.51	0.50	106.36	273.1	104.13	261.8
0.54	0.50	106.17	274.0	103.89	262.7
0.57	0.50	106.08	275.2	103.70	263.9
0.61	0.50	105.91	277.7	103.35	264.0
0.64	0.50	106.01	279.2	103.28	265.9
0.67	0.50	105.61	279.8	103.11	267.7
0.70	0.50	105.57	280.8	103.03	269.8
0.73	0.50	105.61	282.1	103.51	269.1
0.77	0.50	105.47	283.2	102.94	269.9
0.80	0.50	105.37	284.6	102.81	270.9

0.83	0.50	105.28	286.1	102.68	272.0
0.86	0.50	105.19	287.7	102.55	273.1
0.89	0.50	105.10	289.2	102.42	274.2
0.93	0.50	105.01	290.9	102.29	275.4
0.96	0.50	104.92	292.6	102.16	276.5
0.99	0.50	104.83	294.4	102.03	277.7

Centerline Probe data

x/L	spl	phase
-0.86	116.5	138.0
-0.84	116.5	130.1
-0.82	116.4	122.1
-0.80	116.3	114.0
-0.77	116.2	105.6
-0.75	115.9	96.9
-0.73	115.7	87.8
-0.70	115.5	77.6
-0.68	115.3	67.0
-0.66	115.1	56.0
-0.64	115.0	44.6
-0.61	115.0	33.0
-0.59	115.1	21.4
-0.57	115.2	10.5
-0.55	115.4	0.1
-0.52	115.6	350.1
-0.50	115.8	340.6
-0.48	115.9	331.8
-0.45	116.0	323.0
-0.43	116.1	314.6
-0.41	116.0	306.2
-0.39	115.9	297.8
-0.36	115.8	289.0
-0.34	115.5	279.6
-0.32	115.3	269.8
-0.30	115.0	259.6
-0.27	114.8	248.6
-0.25	114.7	237.1
-0.23	114.6	225.0
-0.20	114.7	213.0
-0.18	114.9	201.4
-0.16	115.2	190.1
-0.14	115.6	179.8
-0.11	115.9	169.9
-0.09	116.2	160.9
-0.07	116.5	152.4
-0.05	116.7	144.5
-0.02	116.9	136.9
0.00	116.9	129.7
0.02	116.9	122.4
0.05	116.8	115.4
0.07	116.7	108.4
0.09	116.4	101.2
0.11	116.1	93.8
0.14	115.7	85.9
0.16	115.2	77.5
0.18	114.7	68.4
0.20	114.2	58.5
0.23	113.7	47.8
0.25	113.3	36.5
0.27	113.1	24.4
0.30	113.0	12.2
0.32	113.1	0.7
0.34	113.2	349.6
0.36	113.5	339.5
0.39	113.8	330.5
0.41	114.0	322.3
0.43	114.2	315.0
0.45	114.3	308.3
0.48	114.3	301.9
0.50	114.1	295.9
0.52	113.8	289.6
0.55	113.4	283.6
0.57	112.8	276.7
0.59	112.0	269.3
0.61	111.2	260.4
0.64	110.3	250.1
0.66	109.4	237.9
0.68	108.7	223.6
0.70	108.3	207.7

0.73	108.4	191.5
0.75	108.8	176.9
0.77	109.5	164.3
0.80	110.3	153.8
0.82	111.1	145.4
0.84	111.7	138.7
0.86	112.1	132.9
0.89	112.4	128.3
0.91	112.5	124.3
0.93	112.4	120.6
0.95	112.1	117.3
0.98	111.6	113.5
1.00	110.8	109.6
1.02	109.8	105.0
1.05	108.3	99.2
1.07	106.6	91.2
1.09	104.3	78.6
1.11	101.9	58.1
1.14	100.6	26.0
1.16	101.8	353.6
1.18	104.3	332.7
1.20	106.5	320.8
1.23	108.2	313.3
1.25	109.6	308.0
1.27	110.6	304.0
1.30	111.3	300.8
1.32	111.7	298.4
1.34	111.8	296.0
1.36	111.6	293.5
1.39	111.2	291.1
1.41	110.6	288.1
1.43	109.5	284.4
1.45	108.3	279.5
1.48	106.5	272.7
1.50	104.3	261.7
1.52	101.6	243.2
1.55	99.6	211.1

Plane locations (w. r. t. streamwise location of
 liner x = 0.0)
 plane 1: -7.5 in.
 Plane 3: +16.0 in.
 Planes 2 and 4 are 0.3 in. behind planes 1 and 3,
 respectively.
 L = 11.0 in.
 w = 4.7 in.
 h = 2.0 in.

Liner

M = 0.0

T = 78 F

2000 Hz

source plane data

y/w	z/h	spl	phase	spl	phase
0.00	0.50	115.07	249.0	115.04	239.8
0.03	0.50	115.06	252.2	115.02	238.3
0.06	0.50	115.05	252.0	115.02	238.6
0.10	0.50	115.03	251.8	115.01	239.1
0.13	0.50	115.02	251.6	115.00	239.4
0.16	0.50	115.00	251.4	114.98	239.6
0.19	0.50	114.98	251.2	114.96	239.7
0.22	0.50	114.96	251.2	114.94	239.8
0.26	0.50	114.92	251.3	114.91	239.9
0.29	0.50	114.89	251.4	114.86	239.7
0.32	0.50	114.84	251.5	114.81	239.6
0.35	0.50	114.81	251.6	114.75	239.7
0.38	0.50	114.73	252.2	114.67	239.4
0.41	0.50	114.66	252.3	114.59	239.8
0.45	0.50	114.59	252.4	114.49	239.6
0.48	0.50	114.51	252.6	114.36	239.5
0.51	0.50	114.41	253.0	114.28	239.6
0.54	0.50	114.33	253.6	114.18	240.4
0.57	0.50	114.25	254.2	114.08	240.9
0.61	0.50	114.15	254.7	113.93	240.0
0.64	0.50	114.04	254.6	113.84	239.6
0.67	0.50	113.97	255.3	113.77	239.6
0.70	0.50	113.95	256.4	113.65	240.3
0.73	0.50	113.89	257.1	113.57	240.5
0.77	0.50	113.69	257.2	113.35	240.2
0.80	0.50	113.57	257.9	113.20	240.2
0.83	0.50	113.45	258.5	113.04	240.2
0.86	0.50	113.33	259.2	112.88	240.2
0.89	0.50	113.20	260.0	112.71	240.2
0.93	0.50	113.07	260.7	112.54	240.3
0.96	0.50	112.93	261.5	112.36	240.3
0.99	0.50	112.79	262.4	112.17	240.3

Exit Plane Data

		X3 Plane		X4 Plane	
y/w	z/h	spl	phase	spl	phase
0.00	0.50	100.19	35.9	102.64	18.2
0.03	0.50	100.30	33.6	102.57	18.7
0.06	0.50	100.26	33.4	102.53	19.3
0.10	0.50	100.25	33.5	102.38	19.3
0.13	0.50	100.14	33.5	102.25	19.8
0.16	0.50	100.19	31.8	102.70	15.2
0.19	0.50	100.34	29.1	102.99	16.5
0.22	0.50	100.69	31.1	103.03	18.7
0.26	0.50	100.64	31.7	102.93	20.1
0.29	0.50	100.61	37.9	102.53	18.5
0.32	0.50	100.10	34.3	102.48	19.1
0.35	0.50	100.12	35.3	102.46	18.1
0.38	0.50	100.20	34.4	102.64	18.1
0.41	0.50	100.29	34.2	102.41	18.2
0.45	0.50	100.36	34.2	102.29	20.2
0.48	0.50	100.38	33.7	102.28	20.7
0.51	0.50	100.32	34.1	102.23	20.9
0.54	0.50	100.33	34.3	102.24	20.6
0.57	0.50	100.18	35.4	102.24	21.0
0.61	0.50	99.92	38.0	103.19	17.1
0.64	0.50	100.14	37.0	103.29	17.2
0.67	0.50	99.44	44.6	102.73	17.5
0.70	0.50	102.28	53.0	102.61	17.7
0.73	0.50	100.19	40.1	102.42	18.8
0.77	0.50	100.50	46.6	102.69	18.1
0.80	0.50	100.53	48.4	102.71	18.0

0.83	0.50	100.56	50.3	102.73	17.8
0.86	0.50	100.60	52.4	102.76	17.6
0.89	0.50	100.63	54.5	102.79	17.4
0.93	0.50	100.67	56.7	102.82	17.1
0.96	0.50	100.70	59.1	102.85	16.9
0.99	0.50	100.74	61.5	102.88	16.6

Centerline Probe data

x/L spl phase

-0.86	114.2	352.9
-0.84	114.3	339.5
-0.82	114.5	326.5
-0.80	114.6	313.9
-0.77	114.7	301.6
-0.75	114.7	289.6
-0.73	114.7	277.9
-0.70	114.6	265.4
-0.68	114.5	252.6
-0.66	114.4	239.5
-0.64	114.2	225.9
-0.61	114.1	211.9
-0.59	114.1	197.9
-0.57	114.2	184.0
-0.55	114.3	170.6
-0.52	114.4	157.5
-0.50	114.5	144.9
-0.48	114.6	132.8
-0.45	114.6	120.8
-0.43	114.6	108.8
-0.41	114.5	96.7
-0.39	114.3	84.3
-0.36	114.1	71.3
-0.34	113.9	57.5
-0.32	113.7	43.3
-0.30	113.6	28.8
-0.27	113.6	13.9
-0.25	113.7	359.2
-0.23	113.8	344.8
-0.20	114.1	331.2
-0.18	114.4	318.2
-0.16	114.6	305.8
-0.14	114.8	294.0
-0.11	114.9	282.5
-0.09	114.9	271.2
-0.07	114.9	259.9
-0.05	114.8	248.6
-0.02	114.7	237.2
0.00	114.5	225.6
0.02	114.3	213.9
0.05	114.0	202.2
0.07	113.7	190.6
0.09	113.4	178.8
0.11	112.9	166.9
0.14	112.4	154.7
0.16	111.9	142.1
0.18	111.3	128.9
0.20	110.7	114.6
0.23	110.2	99.6
0.25	109.9	84.1
0.27	109.6	68.7
0.30	109.6	53.5
0.32	109.6	39.3
0.34	109.6	26.0
0.36	109.5	13.8
0.39	109.4	2.1
0.41	109.0	350.8
0.43	108.6	339.5
0.45	107.9	327.3
0.48	107.2	313.9
0.50	106.4	298.6
0.52	105.7	281.7
0.55	105.4	263.4
0.57	105.4	245.4
0.59	105.7	229.0
0.61	106.1	214.1
0.64	106.5	201.6
0.66	106.7	190.8
0.68	106.8	180.9
0.70	106.5	171.5

0.73	106.1	162.3
0.75	105.3	152.4
0.77	104.2	141.0
0.80	102.9	126.6
0.82	101.7	108.4
0.84	101.0	86.6
0.86	101.1	64.0
0.89	101.8	44.7
0.91	102.8	29.8
0.93	103.5	18.2
0.95	104.0	8.9
0.98	104.1	0.7
1.00	103.9	353.2
1.02	103.3	345.4
1.05	102.1	336.6
1.07	100.4	324.9
1.09	98.3	306.6
1.11	96.6	277.5
1.14	97.2	243.1
1.16	99.3	218.4
1.18	101.4	203.5
1.20	103.1	194.0
1.23	104.2	186.7
1.25	104.9	180.7
1.27	105.2	175.2
1.30	105.1	169.8
1.32	104.7	164.1
1.34	103.8	157.5
1.36	102.4	148.8
1.39	100.5	136.0
1.41	98.4	115.8
1.43	97.3	85.4
1.45	98.3	54.7
1.48	100.4	33.7
1.50	102.3	20.7
1.52	103.7	12.0
1.55	104.7	5.2

Plane locations (w. r. t. streamwise location of
 liner $x = 0.0$)
 plane 1: -7.5 in.
 Plane 3: +16.0 in.
 Planes 2 and 4 are 0.3 in. behind planes 1 and 3,
 respectively.
 L = 11.0 in.
 w = 4.7 in.
 h = 2.0 in.

Liner
 M = 0.0
 T = 78 F
 2500 Hz

source plane data

y/w	z/h	spl	phase	spl	phase
0.00	0.50	113.17	89.9	112.78	76.8
0.03	0.50	113.36	95.6	112.93	75.0
0.06	0.50	113.39	95.1	112.99	75.3
0.10	0.50	113.43	94.0	113.08	75.5
0.13	0.50	113.49	92.8	113.19	75.2
0.16	0.50	113.56	91.4	113.30	74.4
0.19	0.50	113.63	89.8	113.42	73.4
0.22	0.50	113.72	88.5	113.56	72.3
0.26	0.50	113.85	87.1	113.72	70.9
0.29	0.50	113.98	85.7	113.89	69.2
0.32	0.50	114.13	84.4	114.07	67.5
0.35	0.50	114.32	82.8	114.25	66.3
0.38	0.50	114.48	82.1	114.43	64.3
0.41	0.50	114.65	80.7	114.63	63.4
0.45	0.50	114.82	79.4	114.82	61.8
0.48	0.50	114.99	78.3	115.00	60.4
0.51	0.50	115.16	77.5	115.18	59.7
0.54	0.50	115.31	77.3	115.46	59.2
0.57	0.50	115.46	76.8	115.65	58.9
0.61	0.50	115.63	76.6	115.84	56.9
0.64	0.50	115.78	75.5	116.01	55.7
0.67	0.50	115.92	75.4	116.15	55.2
0.70	0.50	116.05	76.3	116.26	55.2
0.73	0.50	116.16	76.2	116.37	54.8
0.77	0.50	116.51	73.9	116.78	51.9
0.80	0.50	116.71	73.4	117.00	50.8
0.83	0.50	116.92	73.0	117.23	49.7
0.86	0.50	117.13	72.6	117.46	48.5
0.89	0.50	117.35	72.2	117.70	47.4
0.93	0.50	117.57	71.9	117.94	46.3
0.96	0.50	117.80	71.6	118.18	45.1
0.99	0.50	118.03	71.4	118.43	44.0

Exit Plane Data

		X3 Plane		X4 Plane	
y/w	z/h	spl	phase	spl	phase
0.00	0.50	100.79	47.3	100.89	34.0
0.03	0.50	100.87	46.9	100.85	35.0
0.06	0.50	100.85	47.4	100.89	35.9
0.10	0.50	100.85	47.4	100.93	36.8
0.13	0.50	100.91	47.5	101.01	36.7
0.16	0.50	100.94	48.0	101.03	37.5
0.19	0.50	100.95	48.2	101.10	38.0
0.22	0.50	100.98	48.4	101.10	38.3
0.26	0.50	101.00	49.0	101.11	38.7
0.29	0.50	100.99	49.7	101.14	38.8
0.32	0.50	101.01	49.8	101.24	39.8
0.35	0.50	101.04	50.0	101.30	40.8
0.38	0.50	101.10	50.1	101.29	41.3
0.41	0.50	101.12	50.5	101.35	42.0
0.45	0.50	101.14	50.4	101.42	42.2
0.48	0.50	101.13	50.4	101.36	42.3
0.51	0.50	101.07	50.6	101.38	42.9
0.54	0.50	101.12	51.0	101.49	44.0
0.57	0.50	100.96	52.2	101.47	44.3
0.61	0.50	100.93	54.2	101.51	44.0
0.64	0.50	100.84	54.1	101.46	44.5
0.67	0.50	100.79	54.9	101.43	44.8
0.70	0.50	100.69	55.3	101.45	45.2
0.73	0.50	100.56	55.7	101.40	45.4
0.77	0.50	100.59	56.4	101.47	45.9

0.80	0.50	100.51	57.1	101.47	46.2
0.83	0.50	100.43	57.8	101.47	46.5
0.86	0.50	100.33	58.6	101.46	46.8
0.89	0.50	100.24	59.4	101.45	47.1
0.93	0.50	100.13	60.2	101.44	47.3
0.96	0.50	100.02	61.1	101.43	47.6
0.99	0.50	99.91	61.9	101.41	47.8

Centerline Probe data

x/L	spl	phase
-0.86	115.2	207.0
-0.84	115.4	190.7
-0.82	115.6	175.0
-0.80	115.7	159.7
-0.77	115.7	144.5
-0.75	115.5	129.4
-0.73	115.3	113.4
-0.70	115.1	96.3
-0.68	115.0	78.3
-0.66	115.0	60.4
-0.64	115.1	43.0
-0.61	115.3	26.0
-0.59	115.6	10.2
-0.57	115.7	354.8
-0.55	115.8	340.0
-0.52	115.7	324.9
-0.50	115.6	309.7
-0.48	115.3	293.8
-0.45	115.1	277.1
-0.43	115.0	259.7
-0.41	114.9	242.1
-0.39	115.0	224.7
-0.36	115.2	208.3
-0.34	115.2	192.1
-0.32	115.2	176.6
-0.30	115.1	161.3
-0.27	114.8	145.1
-0.25	114.4	127.8
-0.23	114.1	109.0
-0.20	114.1	89.2
-0.18	114.3	69.3
-0.16	114.8	50.3
-0.14	115.4	32.9
-0.11	116.0	17.3
-0.09	116.5	2.7
-0.07	116.9	349.3
-0.05	117.2	336.3
-0.02	117.3	323.6
0.00	117.4	310.7
0.02	117.3	297.9
0.05	117.2	284.9
0.07	117.1	271.9
0.09	116.9	258.8
0.11	116.6	245.5
0.14	116.4	232.2
0.16	116.1	218.8
0.18	115.8	205.4
0.20	115.5	191.8
0.23	115.1	178.1
0.25	114.7	164.3
0.27	114.3	150.4
0.30	113.9	136.2
0.32	113.5	122.0
0.34	113.2	107.7
0.36	112.9	93.5
0.39	112.6	79.4
0.41	112.3	65.6
0.43	112.0	52.2
0.45	111.6	38.7
0.48	111.3	25.2
0.50	110.8	11.4
0.52	110.4	357.6
0.55	109.9	343.5
0.57	109.5	329.2
0.59	109.0	315.1
0.61	108.6	300.2
0.64	108.3	285.7
0.66	107.9	271.4
0.68	107.6	257.2

0.70	107.2	243.0
0.73	106.8	229.1
0.75	106.4	214.9
0.77	106.0	200.4
0.80	105.7	185.8
0.82	105.3	171.0
0.84	105.1	156.3
0.86	104.9	141.4
0.89	104.8	127.1
0.91	104.8	113.7
0.93	104.8	101.2
0.95	104.7	90.0
0.98	104.4	80.0
1.00	103.8	70.7
1.02	102.9	61.8
1.05	101.5	52.6
1.07	99.5	42.3
1.09	96.7	28.3
1.11	92.5	3.9
1.14	89.6	308.1
1.16	93.2	260.7
1.18	96.8	241.2
1.20	99.0	230.2
1.23	100.2	222.1
1.25	100.8	214.7
1.27	100.7	206.4
1.30	100.1	197.1
1.32	99.0	185.1
1.34	97.6	168.7
1.36	96.2	144.5
1.39	96.1	115.0
1.41	97.4	89.1
1.43	99.1	71.7
1.45	100.4	59.9
1.48	101.1	50.4
1.50	101.4	42.3
1.52	101.1	34.2
1.55	100.3	24.8

Plane locations (w. r. t. streamwise location of
 liner $x = 0.0$)
 plane 1: -7.5 in.
 Plane 3: +16.0 in.
 Planes 2 and 4 are 0.3 in. behind planes 1 and 3,
 respectively.
 L = 11.0 in.
 w = 4.7 in.
 h = 2.0 in.

Liner
 M = 0.1
 T = 60 F

500 Hz
 source plane data

y/w	z/h	spl	phase	spl	phase
0.03	0.50	113.71	110.7	112.07	102.5
0.06	0.50	113.58	111.7	112.43	103.9
0.10	0.50	113.50	111.8	112.40	103.3
0.13	0.50	113.45	112.0	112.39	103.2
0.16	0.50	113.48	111.9	112.37	102.4
0.19	0.50	113.44	111.6	112.37	102.2
0.22	0.50	113.48	111.9	112.40	102.2
0.26	0.50	112.86	109.5	112.35	101.8
0.29	0.50	112.59	108.3	112.46	102.0
0.32	0.50	112.52	107.3	112.53	102.3
0.35	0.50	112.55	107.2	112.55	102.3
0.38	0.50	112.56	106.4	112.56	102.3
0.41	0.50	113.07	109.8	112.73	103.2
0.45	0.50	112.49	107.6	112.80	103.6
0.48	0.50	112.65	107.6	112.92	103.6
0.51	0.50	112.78	107.6	112.93	103.7
0.54	0.50	112.91	108.0	113.02	103.2
0.57	0.50	113.12	108.4	113.03	103.6
0.61	0.50	112.80	108.9	113.08	103.5
0.64	0.50	113.76	112.8	113.16	103.4
0.67	0.50	113.79	113.1	113.15	103.2
0.70	0.50	113.83	112.9	113.17	103.3
0.73	0.50	113.75	113.0	113.16	103.3
0.77	0.50	113.76	113.8	113.24	103.4
0.80	0.50	114.28	115.2	113.37	103.9
0.83	0.50	114.53	116.3	113.43	104.0
0.86	0.50	114.80	117.5	113.49	104.2
0.89	0.50	115.09	118.8	113.56	104.3
0.93	0.50	115.40	120.2	113.62	104.5
0.96	0.50	115.73	121.7	113.68	104.7
0.99	0.50	116.07	123.3	113.75	104.9

Exit Plane Data

y/w	z/h	X3 Plane		X4 Plane	
		spl	phase	spl	phase
0.03	0.50	109.78	57.8	110.18	56.1
0.06	0.50	109.74	59.2	110.03	56.3
0.10	0.50	109.63	58.2	109.84	55.5
0.13	0.50	109.32	57.8	109.68	55.6
0.16	0.50	109.17	57.9	109.49	55.3
0.19	0.50	109.14	57.7	109.42	55.0
0.22	0.50	109.07	57.5	109.44	55.1
0.26	0.50	109.02	57.5	109.44	55.2
0.29	0.50	109.00	56.8	109.42	55.1
0.32	0.50	108.97	57.4	109.39	54.5
0.35	0.50	108.95	57.6	109.47	54.5
0.38	0.50	108.91	57.2	109.36	54.3
0.41	0.50	108.97	57.0	109.47	53.6
0.45	0.50	108.88	56.7	109.37	53.6
0.48	0.50	108.66	56.4	109.43	53.9
0.51	0.50	108.72	55.7	109.41	53.8
0.54	0.50	108.77	56.1	109.43	53.7
0.57	0.50	108.64	57.5	109.46	53.3
0.61	0.50	108.54	58.1	109.38	53.7
0.64	0.50	108.33	57.2	109.60	53.8
0.67	0.50	108.33	57.1	109.73	53.7
0.70	0.50	108.28	57.6	109.64	53.7
0.73	0.50	108.22	58.5	109.66	54.0
0.77	0.50	108.27	58.6	109.59	54.1
0.80	0.50	108.22	58.6	109.86	54.0
0.83	0.50	108.18	58.9	109.95	54.1

0.86	0.50	108.14	59.2	110.06	54.2
0.89	0.50	108.10	59.6	110.16	54.3
0.93	0.50	108.07	59.9	110.28	54.4
0.96	0.50	108.04	60.4	110.41	54.6
0.99	0.50	108.01	60.8	110.54	54.8

Centerline Probe data

x/L	spl	phase
-0.86	111.6	124.6
-0.82	111.9	119.8
-0.77	112.3	115.5
-0.73	112.5	111.4
-0.68	112.8	107.6
-0.64	112.9	103.7
-0.59	113.0	100.1
-0.55	113.0	96.5
-0.50	113.0	92.8
-0.45	112.8	89.3
-0.41	112.7	85.8
-0.36	112.4	81.6
-0.32	112.1	77.6
-0.27	111.8	73.2
-0.23	111.4	68.2
-0.18	110.8	63.0
-0.14	110.3	57.2
-0.09	109.7	50.5
-0.05	109.2	42.9
0.00	108.6	35.1
0.05	108.1	26.6
0.09	107.6	18.7
0.14	107.0	10.6
0.18	106.3	1.8
0.23	105.5	353.3
0.27	104.6	343.0
0.32	103.8	331.0
0.36	103.0	317.1
0.41	102.6	302.0
0.45	102.7	285.9
0.50	103.1	271.4
0.55	103.7	259.4
0.59	104.4	249.5
0.64	105.1	242.5
0.68	105.5	236.4
0.73	105.9	232.4
0.77	105.8	228.8
0.82	105.6	226.7
0.86	104.9	224.4
0.91	104.0	222.3
0.95	102.4	220.5
1.00	100.2	217.4
1.05	96.7	212.3
1.09	90.8	193.8
1.14	87.4	107.9
1.18	95.1	69.2
1.23	99.6	61.3
1.27	102.6	58.3
1.32	104.7	57.0
1.36	106.3	55.7
1.41	107.8	54.5
1.45	108.7	55.7
1.50	109.4	53.8
1.55	110.1	52.2

Plane locations (w. r. t. streamwise location of
 liner $x = 0.0$)
 plane 1: -7.5 in.
 Plane 3: +16.0 in.
 Planes 2 and 4 are 0.3 in. behind planes 1 and 3,
 respectively.
 L = 11.0 in.
 w = 4.7 in.
 h = 2.0 in.

Liner
 M = 0.1
 T = 60 F

1000 Hz

source plane data

y/w	z/h	spl	phase	spl	phase
0.03	0.50	112.85	287.2	112.00	285.9
0.06	0.50	112.91	288.1	112.01	284.7
0.10	0.50	112.90	287.9	112.05	284.5
0.13	0.50	112.87	288.1	112.12	284.0
0.16	0.50	112.95	288.3	112.09	283.7
0.19	0.50	112.94	288.4	112.11	283.7
0.22	0.50	113.00	288.6	112.16	283.6
0.26	0.50	112.94	289.2	112.17	283.5
0.29	0.50	112.90	289.6	112.21	283.7
0.32	0.50	112.93	289.6	112.20	283.2
0.35	0.50	112.89	289.6	112.27	283.4
0.38	0.50	112.93	289.3	112.25	283.4
0.41	0.50	113.02	289.1	112.27	283.3
0.45	0.50	113.03	289.8	112.31	283.1
0.48	0.50	112.98	289.9	112.26	283.2
0.51	0.50	113.03	289.5	112.33	283.1
0.54	0.50	112.99	289.0	112.33	282.3
0.57	0.50	112.97	289.2	112.35	282.5
0.61	0.50	113.03	290.3	112.38	282.2
0.64	0.50	113.11	289.0	112.38	281.9
0.67	0.50	113.11	288.8	112.39	281.7
0.70	0.50	113.13	288.5	112.40	281.3
0.73	0.50	113.17	288.7	112.38	281.4
0.77	0.50	113.15	288.9	112.42	281.1
0.80	0.50	113.18	288.3	112.42	281.1
0.83	0.50	113.21	288.0	112.42	280.9
0.86	0.50	113.23	287.8	112.43	280.8
0.89	0.50	113.26	287.5	112.43	280.6
0.93	0.50	113.28	287.1	112.44	280.4
0.96	0.50	113.31	286.8	112.44	280.2
0.99	0.50	113.34	286.4	112.44	280.1

Exit Plane Data

		X3 Plane	X4 Plane		
y/w	z/h	spl phase	spl phase		
0.03	0.50	96.84	132.1	95.58	129.9
0.06	0.50	96.22	133.0	95.53	129.5
0.10	0.50	96.47	132.6	95.24	132.4
0.13	0.50	96.31	129.7	95.32	130.1
0.16	0.50	96.89	134.2	95.42	128.2
0.19	0.50	96.60	135.5	95.76	132.3
0.22	0.50	96.53	135.0	95.82	131.1
0.26	0.50	96.50	135.1	95.77	131.4
0.29	0.50	96.61	135.4	95.87	129.4
0.32	0.50	96.48	135.1	95.90	132.8
0.35	0.50	96.25	132.4	96.06	132.1
0.38	0.50	95.99	131.9	96.06	130.3
0.41	0.50	96.67	132.3	96.13	130.7
0.45	0.50	96.23	133.3	96.12	131.3
0.48	0.50	96.46	134.8	96.16	131.4
0.51	0.50	96.34	129.5	96.16	130.0
0.54	0.50	96.06	133.0	96.18	129.8
0.57	0.50	96.13	132.8	96.12	130.2
0.61	0.50	96.13	132.8	96.16	129.5
0.64	0.50	95.72	134.8	96.31	130.3
0.67	0.50	95.80	133.6	96.32	129.7
0.70	0.50	95.81	134.2	96.03	130.3
0.73	0.50	95.86	133.7	95.91	131.4
0.77	0.50	95.76	135.1	95.97	130.2
0.80	0.50	95.60	133.8	96.01	129.8
0.83	0.50	95.51	133.9	95.96	129.6

0.86	0.50	95.42	133.9	95.91	129.4
0.89	0.50	95.33	133.9	95.86	129.2
0.93	0.50	95.23	134.0	95.79	129.0
0.96	0.50	95.13	134.0	95.72	128.8
0.99	0.50	95.02	134.0	95.65	128.6

Centerline Probe data

x/L	spl	phase
-0.86	112.3	312.8
-0.82	113.0	306.1
-0.77	113.3	300.4
-0.73	113.4	295.0
-0.68	113.0	289.5
-0.64	112.3	283.1
-0.59	111.2	274.5
-0.55	109.8	263.3
-0.50	108.2	246.7
-0.45	107.1	223.8
-0.41	107.3	197.4
-0.36	108.6	176.1
-0.32	110.1	161.2
-0.27	111.4	150.5
-0.23	112.3	143.0
-0.18	112.9	136.7
-0.14	113.2	130.9
-0.09	113.2	125.3
-0.05	112.9	119.8
0.00	112.3	113.4
0.05	111.7	106.4
0.09	110.8	98.8
0.14	109.9	91.0
0.18	109.0	82.4
0.23	108.1	74.9
0.27	107.1	66.0
0.32	106.1	56.3
0.36	105.2	46.0
0.41	104.2	35.3
0.45	103.4	24.6
0.50	102.7	13.5
0.55	102.1	1.9
0.59	101.7	352.5
0.64	101.4	343.2
0.68	100.9	335.5
0.73	100.4	328.0
0.77	99.8	321.5
0.82	99.2	316.1
0.86	98.4	311.2
0.91	97.5	306.7
0.95	96.1	304.1
1.00	94.5	300.5
1.05	91.7	296.3
1.09	87.7	291.6
1.14	79.0	272.7
1.18	80.1	161.4
1.23	87.6	137.8
1.27	91.4	133.6
1.32	93.6	132.0
1.36	95.1	131.2
1.41	95.9	131.1
1.45	96.3	129.5
1.50	96.2	130.0
1.55	95.6	125.9

Plane locations (w. r. t. streamwise location of
 liner x = 0.0)
 plane 1: -7.5 in.
 Plane 3: +16.0 in.
 Planes 2 and 4 are 0.3 in. behind planes 1 and 3,
 respectively.
 L = 11.0 in.
 w = 4.7 in.
 h = 2.0 in.

Liner
 M = 0.1
 T = 60 F

1500 Hz
 source plane data

y/w	z/h	spl	phase	spl	phase
0.03	0.50	110.91	148.4	107.02	127.1
0.06	0.50	111.21	150.3	107.59	127.7
0.10	0.50	111.32	149.9	108.11	127.1
0.13	0.50	111.49	148.8	108.54	125.7
0.16	0.50	111.56	147.2	109.10	124.7
0.19	0.50	111.78	145.3	109.56	122.0
0.22	0.50	111.96	142.8	110.05	120.4
0.26	0.50	112.18	140.8	110.55	118.3
0.29	0.50	112.42	138.3	111.06	115.5
0.32	0.50	112.75	134.9	111.64	113.3
0.35	0.50	113.08	131.9	112.15	111.0
0.38	0.50	113.44	128.6	112.69	108.9
0.41	0.50	113.91	125.8	113.20	106.8
0.45	0.50	114.29	123.9	113.72	105.2
0.48	0.50	114.62	122.6	114.23	103.2
0.51	0.50	115.07	120.4	114.73	101.2
0.54	0.50	115.65	117.6	115.20	99.1
0.57	0.50	115.81	114.9	115.61	98.0
0.61	0.50	116.19	113.6	116.00	96.9
0.64	0.50	116.54	113.1	116.40	94.7
0.67	0.50	116.84	112.0	116.76	93.6
0.70	0.50	117.16	110.6	117.08	92.6
0.73	0.50	117.44	109.8	117.36	92.1
0.77	0.50	117.68	109.1	117.67	91.8
0.80	0.50	118.49	104.6	118.26	88.1
0.83	0.50	118.94	102.8	118.62	86.7
0.86	0.50	119.41	101.1	118.98	85.3
0.89	0.50	119.88	99.4	119.32	83.9
0.93	0.50	120.37	97.7	119.66	82.6
0.96	0.50	120.87	96.0	119.99	81.2
0.99	0.50	121.37	94.4	120.31	79.9

Exit Plane Data

		X3 Plane		X4 Plane	
y/w	z/h	spl	phase	spl	phase
0.03	0.50	109.63	8.3	105.28	350.5
0.06	0.50	109.50	6.5	105.07	350.7
0.10	0.50	109.41	7.3	105.00	351.0
0.13	0.50	109.59	7.7	105.19	351.1
0.16	0.50	108.99	7.5	105.06	351.9
0.19	0.50	109.27	9.2	104.70	353.1
0.22	0.50	110.07	10.5	105.07	354.2
0.26	0.50	109.45	11.3	105.15	353.8
0.29	0.50	109.42	10.4	105.27	354.8
0.32	0.50	109.67	12.0	105.63	357.4
0.35	0.50	109.56	14.1	105.63	359.0
0.38	0.50	109.66	15.3	105.66	0.7
0.41	0.50	109.72	15.3	105.68	2.9
0.45	0.50	109.83	15.5	105.90	3.9
0.48	0.50	109.55	16.7	105.89	7.1
0.51	0.50	109.47	18.6	105.76	8.8
0.54	0.50	109.95	21.2	105.78	11.3
0.57	0.50	109.88	22.9	106.11	10.7
0.61	0.50	109.90	23.4	106.24	11.6
0.64	0.50	110.15	25.1	106.20	11.5
0.67	0.50	110.45	25.8	106.35	13.5
0.70	0.50	110.51	27.1	106.33	15.4
0.73	0.50	110.61	27.6	106.28	15.9
0.77	0.50	110.71	28.6	105.87	17.0
0.80	0.50	110.84	31.6	106.41	20.3
0.83	0.50	110.99	33.2	106.47	21.9

0.86	0.50	111.15	34.9	106.53	23.6
0.89	0.50	111.33	36.7	106.60	25.4
0.93	0.50	111.50	38.5	106.66	27.1
0.96	0.50	111.69	40.3	106.72	28.9
0.99	0.50	111.88	42.2	106.78	30.7

Centerline Probe data

x/L	spl	phase
-0.86	115.2	186.2
-0.82	115.4	170.1
-0.77	115.5	154.4
-0.73	115.4	138.1
-0.68	115.1	120.4
-0.64	114.7	101.2
-0.59	114.6	81.1
-0.55	114.5	60.8
-0.50	114.7	41.3
-0.45	114.8	23.3
-0.41	114.9	6.1
-0.36	114.8	349.3
-0.32	114.4	331.2
-0.27	114.0	311.6
-0.23	113.7	290.0
-0.18	113.8	267.2
-0.14	114.3	245.7
-0.09	114.9	226.8
-0.05	115.4	209.6
0.00	115.8	194.7
0.05	116.0	181.0
0.09	115.9	168.3
0.14	115.3	155.5
0.18	114.4	141.1
0.23	113.2	125.3
0.27	112.1	103.8
0.32	111.5	78.7
0.36	111.9	54.4
0.41	112.7	34.8
0.45	113.5	20.2
0.50	113.8	8.7
0.55	113.5	358.7
0.59	112.5	348.6
0.64	110.8	335.6
0.68	108.5	315.7
0.73	106.7	284.2
0.77	107.3	248.3
0.82	109.4	223.7
0.86	111.3	210.2
0.91	112.4	202.4
0.95	112.5	197.3
1.00	111.7	192.8
1.05	109.7	187.3
1.09	106.0	176.8
1.14	99.7	142.3
1.18	101.3	62.0
1.23	107.1	37.6
1.27	110.2	30.5
1.32	111.8	27.1
1.36	112.2	25.1
1.41	111.4	22.8
1.45	109.5	18.6
1.50	105.8	8.8
1.55	99.3	327.0

Plane locations (w. r. t. streamwise location of
 liner x = 0.0)
 plane 1: -7.5 in.
 Plane 3: +16.0 in.
 Planes 2 and 4 are 0.3 in. behind planes 1 and 3,
 respectively.
 L = 11.0 in.
 w = 4.7 in.
 h = 2.0 in.

Liner
 M = 0.1
 T = 60 F

2000 Hz

source plane data

y/w	z/h	spl	phase	spl	phase
0.03	0.50	113.76	308.1	113.63	287.5
0.06	0.50	113.67	311.4	113.61	286.9
0.10	0.50	113.68	311.8	113.58	286.6
0.13	0.50	113.67	312.5	113.58	286.7
0.16	0.50	113.69	313.7	113.55	286.8
0.19	0.50	113.70	314.7	113.57	287.5
0.22	0.50	113.74	315.8	113.51	288.2
0.26	0.50	113.72	316.8	113.51	289.3
0.29	0.50	113.69	317.4	113.53	290.7
0.32	0.50	113.70	318.6	113.51	291.8
0.35	0.50	113.78	319.7	113.54	293.3
0.38	0.50	113.89	320.2	113.54	294.7
0.41	0.50	113.90	323.2	113.55	296.4
0.45	0.50	113.95	323.9	113.56	298.0
0.48	0.50	114.03	325.3	113.60	299.4
0.51	0.50	114.07	325.7	113.61	300.7
0.54	0.50	114.16	326.9	113.65	301.3
0.57	0.50	114.18	328.7	113.71	303.0
0.61	0.50	114.23	330.7	113.77	304.5
0.64	0.50	114.45	334.8	113.82	304.6
0.67	0.50	114.49	336.1	113.85	305.6
0.70	0.50	114.58	337.0	113.92	306.4
0.73	0.50	114.67	338.9	113.95	307.8
0.77	0.50	114.73	340.4	113.96	309.1
0.80	0.50	114.89	342.7	114.08	311.7
0.83	0.50	115.01	344.7	114.15	313.3
0.86	0.50	115.14	346.8	114.22	314.8
0.89	0.50	115.27	349.0	114.30	316.5
0.93	0.50	115.41	351.2	114.38	318.1
0.96	0.50	115.56	353.4	114.47	319.8
0.99	0.50	115.70	355.8	114.56	321.6

Exit Plane Data

		X3 Plane	X4 Plane		
y/w	z/h	spl phase	spl phase		
0.03	0.50	96.95	190.9	102.63	154.5
0.06	0.50	97.13	188.6	102.62	153.2
0.10	0.50	96.84	188.3	102.52	154.9
0.13	0.50	96.78	189.8	102.38	154.5
0.16	0.50	97.13	189.0	102.11	155.4
0.19	0.50	97.54	187.7	101.87	155.3
0.22	0.50	97.19	192.8	102.33	150.5
0.26	0.50	96.94	192.6	102.64	153.1
0.29	0.50	96.71	192.7	102.64	154.1
0.32	0.50	96.85	193.1	103.08	154.9
0.35	0.50	97.20	200.2	102.83	153.8
0.38	0.50	96.50	197.8	102.40	156.5
0.41	0.50	96.53	186.8	102.33	155.1
0.45	0.50	97.02	194.7	102.58	155.7
0.48	0.50	96.30	193.5	102.37	156.6
0.51	0.50	97.37	198.6	102.29	155.3
0.54	0.50	97.01	195.7	102.22	154.8
0.57	0.50	97.21	198.6	102.12	154.7
0.61	0.50	97.14	201.6	102.05	155.6
0.64	0.50	97.25	209.3	101.69	155.7
0.67	0.50	97.58	213.9	101.21	150.7
0.70	0.50	97.77	216.7	101.23	156.8
0.73	0.50	97.61	218.1	101.72	157.8
0.77	0.50	96.63	228.3	101.63	159.0
0.80	0.50	97.49	226.3	101.17	157.3
0.83	0.50	97.57	230.4	101.00	157.6

0.86	0.50	97.65	234.7	100.83	157.9
0.89	0.50	97.74	239.2	100.64	158.3
0.93	0.50	97.84	244.0	100.45	158.7
0.96	0.50	97.93	248.9	100.25	159.1
0.99	0.50	98.04	254.1	100.04	159.5

Centerline Probe data

x/L	spl	phase
-0.86	113.5	58.9
-0.82	113.9	33.0
-0.77	114.3	9.6
-0.73	114.4	348.5
-0.68	114.1	325.7
-0.64	113.6	300.7
-0.59	113.3	273.3
-0.55	113.5	246.3
-0.50	113.9	221.3
-0.45	114.2	198.9
-0.41	114.1	177.0
-0.36	113.6	153.9
-0.32	112.9	127.1
-0.27	112.7	97.7
-0.23	113.1	68.5
-0.18	113.8	42.9
-0.14	114.4	20.7
-0.09	114.6	0.4
-0.05	114.4	339.4
0.00	113.9	317.6
0.05	113.4	294.5
0.09	112.9	271.8
0.14	112.1	249.3
0.18	111.0	225.6
0.23	109.8	200.4
0.27	109.0	170.0
0.32	108.9	139.3
0.36	109.2	113.2
0.41	109.2	91.7
0.45	108.4	71.5
0.50	106.8	47.9
0.55	105.1	15.3
0.59	105.0	337.3
0.64	106.3	308.0
0.68	107.3	288.5
0.73	107.1	273.6
0.77	105.6	259.0
0.82	102.3	235.5
0.86	99.6	186.6
0.91	102.0	139.8
0.95	104.6	118.5
1.00	105.4	106.4
1.05	104.4	95.9
1.09	101.1	78.8
1.14	96.5	27.3
1.18	100.5	327.6
1.23	104.4	308.8
1.27	106.2	300.4
1.32	106.2	293.0
1.36	104.4	283.8
1.41	100.2	262.5
1.45	97.4	198.6
1.50	102.3	155.3
1.55	105.4	133.5

Plane locations (w. r. t. streamwise location of
 liner x = 0.0)
 plane 1: -7.5 in.
 Plane 3: +16.0 in.
 Planes 2 and 4 are 0.3 in. behind planes 1 and 3,
 respectively.
 L = 11.0 in.
 w = 4.7 in.
 h = 2.0 in.

Liner
 M = 0.1
 T = 60 F

2500 Hz

source plane data

y/w	z/h	spl	phase	spl	phase
0.03	0.50	113.73	169.2	113.01	150.1
0.06	0.50	114.06	174.8	113.28	148.0
0.10	0.50	114.04	175.2	113.22	146.5
0.13	0.50	114.04	175.0	113.25	145.0
0.16	0.50	114.12	175.5	113.22	143.9
0.19	0.50	114.14	175.4	113.25	142.4
0.22	0.50	114.20	175.1	113.26	141.5
0.26	0.50	113.95	175.9	113.31	140.6
0.29	0.50	113.79	175.5	113.45	139.7
0.32	0.50	113.72	174.5	113.53	138.8
0.35	0.50	113.76	173.1	113.65	137.7
0.38	0.50	113.82	171.9	113.78	137.1
0.41	0.50	114.51	172.0	113.98	136.2
0.45	0.50	114.17	172.3	114.11	135.7
0.48	0.50	114.20	170.7	114.28	134.8
0.51	0.50	114.35	168.7	114.43	134.0
0.54	0.50	114.46	167.1	114.59	132.2
0.57	0.50	114.62	167.3	114.76	132.2
0.61	0.50	114.75	169.3	114.92	131.9
0.64	0.50	115.81	170.7	115.10	129.7
0.67	0.50	115.99	170.8	115.26	128.8
0.70	0.50	116.14	170.6	115.40	128.5
0.73	0.50	116.33	171.4	115.54	128.7
0.77	0.50	116.46	172.1	115.65	128.8
0.80	0.50	116.92	169.2	116.04	127.6
0.83	0.50	117.29	169.0	116.26	127.1
0.86	0.50	117.68	168.7	116.50	126.6
0.89	0.50	118.08	168.5	116.75	126.2
0.93	0.50	118.51	168.3	117.00	125.9
0.96	0.50	118.96	168.0	117.26	125.5
0.99	0.50	119.43	167.8	117.53	125.2

Exit Plane Data

		X3 Plane	X4 Plane		
y/w	z/h	spl phase	spl phase		
0.03	0.50	100.84	215.9	101.82	200.2
0.06	0.50	101.02	216.3	101.81	201.2
0.10	0.50	101.07	216.9	101.78	202.8
0.13	0.50	101.07	217.4	101.80	204.1
0.16	0.50	100.95	218.7	101.72	204.9
0.19	0.50	100.90	219.5	101.70	205.1
0.22	0.50	100.82	220.3	101.74	205.2
0.26	0.50	100.80	220.8	101.72	205.1
0.29	0.50	100.69	220.2	101.75	205.3
0.32	0.50	100.68	219.6	101.79	205.2
0.35	0.50	100.66	219.3	101.74	205.0
0.38	0.50	100.58	218.3	101.71	204.6
0.41	0.50	100.51	218.5	101.62	204.3
0.45	0.50	100.29	218.8	101.62	203.8
0.48	0.50	100.10	219.1	101.58	203.9
0.51	0.50	99.91	218.8	101.64	203.3
0.54	0.50	99.88	219.6	101.59	203.2
0.57	0.50	99.57	220.2	101.59	203.1
0.61	0.50	99.22	221.6	101.59	203.2
0.64	0.50	98.44	225.2	101.76	202.6
0.67	0.50	98.10	227.5	101.86	202.4
0.70	0.50	97.97	227.9	101.74	202.6
0.73	0.50	97.55	229.7	101.71	203.5
0.77	0.50	97.15	231.9	101.63	203.7
0.80	0.50	96.77	231.2	101.73	201.4
0.83	0.50	96.31	232.7	101.74	200.9

0.86	0.50	95.84	234.3	101.76	200.3
0.89	0.50	95.34	235.9	101.78	199.7
0.93	0.50	94.82	237.6	101.80	199.0
0.96	0.50	94.28	239.4	101.82	198.4
0.99	0.50	93.71	241.3	101.85	197.6

Centerline Probe data

x/L	spl	phase
-0.86	114.6	289.7
-0.82	115.0	258.5
-0.77	115.2	230.0
-0.73	114.9	201.6
-0.68	114.4	168.7
-0.64	114.4	134.0
-0.59	115.0	101.9
-0.55	115.3	74.1
-0.50	115.1	46.0
-0.45	114.5	15.7
-0.41	114.2	341.8
-0.36	114.5	309.1
-0.32	114.6	279.5
-0.27	114.1	250.2
-0.23	113.3	215.4
-0.18	113.5	176.1
-0.14	114.7	140.9
-0.09	116.0	112.6
-0.05	116.6	88.5
0.00	116.8	65.0
0.05	116.6	40.5
0.09	116.2	15.3
0.14	115.7	349.8
0.18	115.2	324.3
0.23	114.6	301.3
0.27	113.8	275.6
0.32	112.9	248.9
0.36	112.1	221.1
0.41	111.5	193.0
0.45	111.0	166.6
0.50	110.5	141.6
0.55	109.5	117.0
0.59	108.4	91.2
0.64	107.2	63.1
0.68	106.4	32.1
0.73	106.1	2.5
0.77	106.0	336.4
0.82	105.7	312.8
0.86	104.9	289.6
0.91	103.8	263.4
0.95	103.1	235.1
1.00	102.5	211.0
1.05	101.1	191.5
1.09	97.2	170.9
1.14	89.1	111.1
1.18	95.6	24.1
1.23	100.2	6.3
1.27	101.4	355.9
1.32	100.2	341.6
1.36	96.9	312.4
1.41	96.3	254.1
1.45	99.9	218.8
1.50	101.6	203.3
1.55	101.1	180.9

Plane locations (w. r. t. streamwise location of
 liner $x = 0.0$)
 plane 1: -7.5 in.
 Plane 3: +16.0 in.
 Planes 2 and 4 are 0.3 in. behind planes 1 and 3,
 respectively.
 L = 11.0 in.
 w = 4.7 in.
 h = 2.0 in.

Liner
 M = 0.2
 T = 56 F

500 Hz
 source plane data

y/w	z/h	spl	phase	spl	phase
0.03	0.50	113.55	83.6	113.18	128.8
0.06	0.50	111.71	104.0	112.91	132.1
0.10	0.50	111.89	109.2	112.67	135.5
0.13	0.50	111.48	108.6	112.23	133.8
0.16	0.50	111.76	104.3	112.37	134.2
0.19	0.50	107.43	144.3	112.14	132.7
0.22	0.50	107.30	148.1	112.42	130.0
0.26	0.50	107.66	143.0	112.56	128.1
0.29	0.50	108.71	136.7	112.24	126.8
0.32	0.50	108.91	134.5	112.07	123.8
0.35	0.50	107.11	136.5	112.34	125.0
0.38	0.50	103.92	152.1	111.98	122.2
0.41	0.50	104.89	154.3	111.69	122.2
0.45	0.50	110.05	130.1	112.27	114.4
0.48	0.50	111.49	128.5	111.73	114.2
0.51	0.50	111.41	127.2	111.86	122.7
0.54	0.50	112.46	129.6	112.04	129.0
0.57	0.50	112.77	132.3	113.09	132.8
0.61	0.50	113.54	116.5	114.12	134.9
0.64	0.50	114.04	121.3	115.16	144.9
0.67	0.50	114.24	115.3	114.30	106.8
0.70	0.50	114.44	112.7	114.61	101.9
0.73	0.50	113.28	115.8	114.55	113.8
0.77	0.50	113.58	116.9	114.57	110.0
0.80	0.50	114.00	128.3	115.71	112.9
0.83	0.50	113.86	124.3	116.21	111.5
0.86	0.50	113.62	118.5	116.75	110.1
0.89	0.50	113.26	110.9	117.32	108.7
0.93	0.50	112.59	101.4	117.91	107.2
0.96	0.50	111.92	90.0	118.54	105.7
0.99	0.50	111.20	76.7	119.21	104.1

Exit Plane Data

		X3 Plane		X4 Plane	
y/w	z/h	spl	phase	spl	phase
0.03	0.50	107.03	97.2	108.68	98.5
0.06	0.50	107.19	102.6	108.18	96.9
0.10	0.50	106.41	99.8	107.74	96.5
0.13	0.50	106.34	96.3	106.64	98.9
0.16	0.50	106.05	96.7	106.75	95.8
0.19	0.50	105.50	94.8	106.89	97.1
0.22	0.50	105.85	96.6	107.08	98.6
0.26	0.50	105.72	95.9	107.07	95.5
0.29	0.50	105.89	96.7	107.28	96.0
0.32	0.50	106.09	95.6	107.54	94.9
0.35	0.50	105.91	93.5	107.69	97.1
0.38	0.50	105.74	96.3	107.06	97.1
0.41	0.50	105.70	96.1	107.35	95.5
0.45	0.50	106.27	96.9	107.08	96.6
0.48	0.50	106.25	94.7	107.81	93.7
0.51	0.50	106.22	93.7	107.39	92.3
0.54	0.50	105.95	91.8	107.50	90.7
0.57	0.50	106.29	92.4	107.37	92.6
0.61	0.50	106.17	91.8	107.79	93.5
0.64	0.50	107.19	93.8	107.29	93.3
0.67	0.50	108.04	93.3	108.90	94.1
0.70	0.50	107.35	93.5	108.41	94.6
0.73	0.50	107.41	93.6	108.36	94.0
0.77	0.50	107.46	94.1	108.37	93.6
0.80	0.50	108.24	93.4	108.94	93.1
0.83	0.50	108.60	93.5	109.20	93.0

0.86	0.50	108.97	93.6	109.48	93.0
0.89	0.50	109.38	93.7	109.77	92.9
0.93	0.50	109.80	93.9	110.09	92.9
0.96	0.50	110.25	94.1	110.41	92.9
0.99	0.50	110.72	94.3	110.76	92.9

Centerline Probe data

x/L	spl	phase
-0.86	109.1	135.6
-0.82	109.5	134.6
-0.77	110.1	133.7
-0.73	110.8	130.5
-0.68	111.4	127.2
-0.64	111.9	122.7
-0.59	112.0	117.3
-0.55	111.8	113.6
-0.50	111.7	110.3
-0.45	111.3	106.5
-0.41	110.7	104.8
-0.36	110.4	104.5
-0.32	110.4	102.1
-0.27	110.2	99.3
-0.23	109.9	95.5
-0.18	109.4	89.3
-0.14	108.9	82.0
-0.09	108.1	74.2
-0.05	107.3	64.6
0.00	106.5	56.3
0.05	106.1	48.3
0.09	105.4	39.1
0.14	104.6	32.0
0.18	104.3	28.5
0.23	104.2	21.7
0.27	103.7	17.0
0.32	102.9	9.6
0.36	102.6	4.1
0.41	101.8	354.1
0.45	101.4	335.2
0.50	100.9	320.1
0.55	101.0	303.2
0.59	101.8	284.6
0.64	102.6	272.8
0.68	103.5	267.0
0.73	103.4	259.2
0.77	103.8	254.6
0.82	104.1	257.3
0.86	103.8	257.0
0.91	103.7	256.9
0.95	102.9	258.0
1.00	101.9	256.5
1.05	99.9	261.4
1.09	98.1	252.9
1.14	91.9	245.6
1.18	85.3	188.7
1.23	93.1	115.8
1.27	98.6	93.9
1.32	101.6	90.4
1.36	103.8	91.4
1.41	104.7	93.6
1.45	106.2	93.7
1.50	107.4	92.3
1.55	108.4	90.8

Plane locations (w. r. t. streamwise location of
 liner x = 0.0)
 plane 1: -7.5 in.
 Plane 3: +16.0 in.
 Planes 2 and 4 are 0.3 in. behind planes 1 and 3,
 respectively.
 L = 11.0 in.
 w = 4.7 in.
 h = 2.0 in.

Liner
 M = 0.2
 T = 56 F

1000 Hz
 source plane data

y/w	z/h	spl	phase	spl	phase
0.03	0.50	111.50	295.1	113.17	308.3
0.06	0.50	111.52	302.0	112.90	307.6
0.10	0.50	111.58	302.6	112.98	308.8
0.13	0.50	111.56	302.4	113.17	307.2
0.16	0.50	111.58	301.3	113.09	307.4
0.19	0.50	112.97	321.4	113.27	307.3
0.22	0.50	113.33	322.5	113.16	306.5
0.26	0.50	113.28	321.2	112.90	306.0
0.29	0.50	112.83	315.8	113.00	305.3
0.32	0.50	112.63	315.5	112.79	305.1
0.35	0.50	112.09	319.0	112.97	304.6
0.38	0.50	112.44	330.5	112.99	306.2
0.41	0.50	113.82	333.8	112.88	304.7
0.45	0.50	113.54	314.7	112.83	304.4
0.48	0.50	113.58	314.8	112.95	307.5
0.51	0.50	113.78	315.8	113.54	310.8
0.54	0.50	114.11	317.0	113.64	313.7
0.57	0.50	114.26	318.6	114.62	313.6
0.61	0.50	113.99	312.9	114.68	311.3
0.64	0.50	114.27	317.1	116.19	314.4
0.67	0.50	113.79	310.6	113.31	307.3
0.70	0.50	113.30	310.5	113.12	306.1
0.73	0.50	113.53	311.2	113.18	305.6
0.77	0.50	113.66	309.5	112.96	303.3
0.80	0.50	113.68	302.0	113.90	308.3
0.83	0.50	113.62	298.4	113.95	308.3
0.86	0.50	113.54	294.4	113.99	308.3
0.89	0.50	113.45	290.2	114.04	308.3
0.93	0.50	113.34	285.6	114.09	308.4
0.96	0.50	113.23	280.8	114.14	308.4
0.99	0.50	113.09	275.6	114.19	308.4

Exit Plane Data

		X3 Plane	X4 Plane
y/w	z/h	spl phase	spl phase
0.03	0.50	98.78 179.6	98.01 185.9
0.06	0.50	98.55 179.8	97.85 179.6
0.10	0.50	98.49 186.7	97.44 192.2
0.13	0.50	97.84 175.6	97.43 185.7
0.16	0.50	98.50 185.6	97.91 181.4
0.19	0.50	98.19 182.2	97.99 187.9
0.22	0.50	97.86 183.8	97.52 186.5
0.26	0.50	97.84 185.4	98.37 187.0
0.29	0.50	98.04 185.1	97.41 184.8
0.32	0.50	98.42 182.1	97.90 188.9
0.35	0.50	97.89 185.6	97.92 187.6
0.38	0.50	98.29 181.9	97.06 184.4
0.41	0.50	98.41 178.1	97.86 181.9
0.45	0.50	98.05 178.9	96.96 186.9
0.48	0.50	98.67 181.3	97.80 188.1
0.51	0.50	99.00 178.5	98.04 180.1
0.54	0.50	97.97 176.7	98.37 182.3
0.57	0.50	98.39 176.6	98.66 178.5
0.61	0.50	98.55 179.0	98.94 178.6
0.64	0.50	99.71 179.9	98.08 179.0
0.67	0.50	100.05 179.3	99.05 177.7
0.70	0.50	100.47 180.7	99.50 179.3
0.73	0.50	99.88 178.2	98.87 187.7
0.77	0.50	99.48 176.4	98.73 174.7
0.80	0.50	100.52 176.0	99.45 176.4
0.83	0.50	100.84 175.3	99.67 175.4

0.86	0.50	101.17	174.6	99.89	174.3
0.89	0.50	101.52	173.9	100.13	173.2
0.93	0.50	101.89	173.1	100.38	172.0
0.96	0.50	102.28	172.3	100.65	170.8
0.99	0.50	102.69	171.4	100.92	169.5

Centerline Probe data

x/L	spl	phase
-0.86	110.9	339.4
-0.82	112.3	331.3
-0.77	113.0	324.7
-0.73	113.7	320.8
-0.68	113.8	315.8
-0.64	113.5	310.8
-0.59	113.0	307.1
-0.55	111.9	301.2
-0.50	110.3	291.7
-0.45	108.5	277.1
-0.41	107.1	254.5
-0.36	106.9	227.3
-0.32	108.3	203.3
-0.27	110.1	189.3
-0.23	111.7	179.6
-0.18	112.8	173.1
-0.14	113.3	168.2
-0.09	113.7	163.9
-0.05	113.6	160.1
0.00	113.3	156.0
0.05	112.7	149.9
0.09	112.1	145.1
0.14	111.3	137.8
0.18	110.7	130.2
0.23	109.7	122.8
0.27	108.9	114.6
0.32	107.7	108.2
0.36	107.0	97.9
0.41	106.0	88.6
0.45	105.0	77.7
0.50	104.1	68.8
0.55	103.7	57.6
0.59	103.2	45.4
0.64	102.7	38.2
0.68	102.2	28.5
0.73	102.2	18.1
0.77	101.8	9.7
0.82	101.2	1.9
0.86	100.8	359.8
0.91	100.4	353.5
0.95	99.4	350.9
1.00	98.5	348.8
1.05	97.3	345.4
1.09	95.4	339.6
1.14	92.6	342.2
1.18	85.3	340.2
1.23	76.1	231.9
1.27	88.2	187.3
1.32	93.1	180.8
1.36	95.9	177.2
1.41	97.2	180.3
1.45	99.0	178.5
1.50	98.0	180.1
1.55	98.7	175.4

Plane locations (w. r. t. streamwise location of
 liner $x = 0.0$)
 plane 1: -7.5 in.
 Plane 3: +16.0 in.
 Planes 2 and 4 are 0.3 in. behind planes 1 and 3,
 respectively.
 L = 11.0 in.
 w = 4.7 in.
 h = 2.0 in.

Liner
 M = 0.2
 T = 56 F

1500 Hz
 source plane data

y/w	z/h	spl	phase	spl	phase
0.03	0.50	108.56	190.7	108.88	174.4
0.06	0.50	108.34	191.4	109.09	175.0
0.10	0.50	108.49	189.0	109.25	173.1
0.13	0.50	108.61	189.5	109.43	171.4
0.16	0.50	108.85	187.4	109.51	169.1
0.19	0.50	109.81	193.9	109.82	167.3
0.22	0.50	110.03	192.1	110.11	164.6
0.26	0.50	109.89	191.7	110.41	162.0
0.29	0.50	109.87	187.2	110.64	160.9
0.32	0.50	109.88	183.9	111.10	159.2
0.35	0.50	109.85	182.3	111.31	156.2
0.38	0.50	110.13	181.1	111.65	154.9
0.41	0.50	111.87	179.6	112.01	155.4
0.45	0.50	112.24	169.8	112.40	151.1
0.48	0.50	112.74	167.4	112.69	150.9
0.51	0.50	113.24	165.6	113.43	149.3
0.54	0.50	113.63	163.7	113.92	147.8
0.57	0.50	114.17	162.3	114.40	146.1
0.61	0.50	113.93	162.5	114.76	144.2
0.64	0.50	114.76	162.0	115.53	140.2
0.67	0.50	114.27	157.3	114.93	142.0
0.70	0.50	114.67	157.9	114.89	140.5
0.73	0.50	114.83	156.1	115.42	139.7
0.77	0.50	115.02	156.1	115.58	138.7
0.80	0.50	116.06	148.3	116.49	136.6
0.83	0.50	116.47	145.4	116.88	135.4
0.86	0.50	116.88	142.5	117.27	134.3
0.89	0.50	117.31	139.4	117.67	133.2
0.93	0.50	117.73	136.3	118.08	132.1
0.96	0.50	118.17	133.2	118.49	131.1
0.99	0.50	118.61	129.9	118.91	130.2

Exit Plane Data

		X3 Plane		X4 Plane	
y/w	z/h	spl	phase	spl	phase
0.03	0.50	110.45	100.9	107.87	96.0
0.06	0.50	110.24	99.6	107.91	96.4
0.10	0.50	110.24	101.1	108.22	95.7
0.13	0.50	109.92	100.3	108.23	100.4
0.16	0.50	109.89	101.7	107.94	100.3
0.19	0.50	109.99	101.8	107.94	99.4
0.22	0.50	110.01	101.9	107.81	100.2
0.26	0.50	110.17	102.0	108.13	100.1
0.29	0.50	110.17	103.7	107.95	99.9
0.32	0.50	110.31	103.1	108.10	100.6
0.35	0.50	110.44	104.2	108.40	101.3
0.38	0.50	110.46	104.5	108.40	101.8
0.41	0.50	110.55	105.3	108.35	103.7
0.45	0.50	110.69	106.5	108.53	103.1
0.48	0.50	110.69	107.1	108.71	104.3
0.51	0.50	110.79	106.5	109.12	104.4
0.54	0.50	110.89	103.4	109.33	105.7
0.57	0.50	111.01	104.3	109.35	106.4
0.61	0.50	111.40	107.6	109.52	107.7
0.64	0.50	112.28	108.4	109.53	109.3
0.67	0.50	112.88	106.9	110.22	109.0
0.70	0.50	112.96	108.0	110.46	108.2
0.73	0.50	112.75	108.2	110.22	110.3
0.77	0.50	112.74	110.3	110.28	111.3
0.80	0.50	113.57	109.4	110.90	112.0
0.83	0.50	113.96	109.8	111.18	112.8

0.86	0.50	114.37	110.2	111.47	113.7
0.89	0.50	114.80	110.6	111.78	114.6
0.93	0.50	115.25	111.0	112.10	115.5
0.96	0.50	115.72	111.5	112.43	116.4
0.99	0.50	116.21	111.9	112.78	117.3

Centerline Probe data

x/L	spl	phase
-0.86	112.4	241.3
-0.82	112.2	222.3
-0.77	112.4	202.1
-0.73	112.8	183.3
-0.68	113.2	165.6
-0.64	113.4	149.3
-0.59	113.5	134.6
-0.55	113.4	119.5
-0.50	113.0	104.2
-0.45	112.7	87.5
-0.41	112.4	69.0
-0.36	112.3	49.6
-0.32	112.3	30.0
-0.27	112.5	12.1
-0.23	112.6	354.9
-0.18	112.6	337.8
-0.14	112.5	320.7
-0.09	112.3	302.9
-0.05	112.3	284.0
0.00	112.5	265.6
0.05	112.8	247.6
0.09	113.3	232.1
0.14	113.7	219.1
0.18	113.7	208.1
0.23	113.2	197.5
0.27	112.3	185.8
0.32	110.8	171.1
0.36	109.3	150.2
0.41	108.5	124.2
0.45	109.4	97.7
0.50	110.6	78.2
0.55	111.7	65.9
0.59	112.1	57.7
0.64	111.8	51.3
0.68	110.8	45.0
0.73	108.7	32.9
0.77	105.8	12.2
0.82	103.8	335.1
0.86	105.5	295.8
0.91	108.3	275.9
0.95	110.4	268.4
1.00	111.3	265.6
1.05	111.2	263.7
1.09	109.9	262.0
1.14	107.1	257.7
1.18	101.9	244.0
1.23	95.8	169.2
1.27	104.0	116.3
1.32	108.3	107.8
1.36	110.5	106.7
1.41	111.2	106.6
1.45	110.8	106.5
1.50	109.1	104.4
1.55	105.8	93.4

Plane locations (w. r. t. streamwise location of
 liner x = 0.0)
 plane 1: -7.5 in.
 Plane 3: +16.0 in.
 Planes 2 and 4 are 0.3 in. behind planes 1 and 3,
 respectively.
 L = 11.0 in.
 w = 4.7 in.
 h = 2.0 in.

Liner
 M = 0.2
 T = 56 F

2000 Hz
 source plane data

y/w	z/h	spl	phase	spl	phase
0.03	0.50	113.11	20.6	113.72	4.1
0.06	0.50	113.15	18.2	113.65	3.9
0.10	0.50	113.02	18.9	113.59	2.9
0.13	0.50	112.94	20.4	113.59	4.0
0.16	0.50	112.97	20.6	113.50	2.6
0.19	0.50	112.75	24.7	113.56	3.1
0.22	0.50	112.70	25.1	113.56	2.8
0.26	0.50	112.74	26.4	113.44	3.3
0.29	0.50	112.70	27.1	113.45	3.6
0.32	0.50	112.36	26.8	113.13	3.8
0.35	0.50	111.81	27.4	113.45	5.2
0.38	0.50	111.46	29.7	113.46	6.6
0.41	0.50	112.79	28.2	113.46	8.3
0.45	0.50	113.37	28.2	113.43	10.0
0.48	0.50	113.51	29.2	113.45	11.7
0.51	0.50	113.54	31.3	113.50	12.9
0.54	0.50	113.65	32.7	113.64	15.0
0.57	0.50	113.93	32.2	113.78	15.4
0.61	0.50	113.85	32.4	113.74	17.3
0.64	0.50	113.97	34.1	113.98	18.4
0.67	0.50	113.82	32.6	113.86	19.1
0.70	0.50	114.00	33.2	114.04	18.4
0.73	0.50	114.13	33.5	114.02	20.0
0.77	0.50	114.11	34.1	114.23	20.7
0.80	0.50	114.83	34.2	114.35	24.9
0.83	0.50	115.09	34.4	114.48	26.8
0.86	0.50	115.38	34.5	114.61	28.7
0.89	0.50	115.68	34.6	114.76	30.7
0.93	0.50	115.99	34.6	114.91	32.8
0.96	0.50	116.32	34.6	115.07	35.0
0.99	0.50	116.67	34.5	115.25	37.2

Exit Plane Data

		X3 Plane		X4 Plane	
y/w	z/h	spl	phase	spl	phase
0.03	0.50	101.59	31.6	95.98	338.8
0.06	0.50	101.49	32.9	96.54	335.0
0.10	0.50	101.76	34.2	95.48	338.6
0.13	0.50	100.74	37.8	95.37	339.8
0.16	0.50	99.81	29.3	95.53	332.7
0.19	0.50	100.34	25.2	95.96	333.4
0.22	0.50	100.90	29.8	96.13	331.4
0.26	0.50	100.81	30.8	95.85	330.8
0.29	0.50	100.84	30.9	95.98	329.3
0.32	0.50	100.83	31.8	95.90	331.7
0.35	0.50	101.02	32.5	95.92	332.1
0.38	0.50	101.48	33.9	96.13	328.9
0.41	0.50	101.50	32.7	95.71	328.5
0.45	0.50	101.38	33.4	96.00	329.7
0.48	0.50	101.07	31.6	95.73	328.5
0.51	0.50	101.62	28.6	95.73	330.5
0.54	0.50	101.76	26.3	95.43	329.3
0.57	0.50	101.87	31.3	95.75	328.3
0.61	0.50	102.26	32.3	95.56	330.0
0.64	0.50	103.20	37.6	96.17	326.7
0.67	0.50	104.00	33.8	97.82	323.1
0.70	0.50	104.03	36.1	98.46	318.3
0.73	0.50	103.58	38.6	97.84	319.8
0.77	0.50	103.99	40.1	98.02	319.6
0.80	0.50	104.91	39.8	98.31	319.7
0.83	0.50	105.40	41.0	98.68	318.7

0.86	0.50	105.93	42.3	99.06	317.7
0.89	0.50	106.48	43.7	99.47	316.6
0.93	0.50	107.07	45.6	99.89	315.5
0.96	0.50	107.68	47.1	100.34	314.4
0.99	0.50	108.31	48.8	100.82	313.3

Centerline Probe data

x/L	spl	phase
-0.86	112.3	131.8
-0.82	111.9	103.4
-0.77	112.3	75.5
-0.73	113.1	51.3
-0.68	113.5	31.3
-0.64	113.5	12.9
-0.59	112.9	352.5
-0.55	112.2	327.7
-0.50	112.0	299.8
-0.45	112.5	273.5
-0.41	113.1	251.9
-0.36	113.3	232.3
-0.32	112.8	213.3
-0.27	111.9	190.5
-0.23	111.3	161.4
-0.18	111.6	131.0
-0.14	112.7	105.2
-0.09	113.6	85.6
-0.05	113.9	68.8
0.00	113.5	51.9
0.05	112.8	33.0
0.09	112.0	11.4
0.14	111.4	348.5
0.18	110.9	326.0
0.23	110.2	304.8
0.27	109.1	281.6
0.32	107.7	256.3
0.36	107.2	224.6
0.41	107.6	196.9
0.45	108.3	174.4
0.50	108.0	157.2
0.55	106.9	139.2
0.59	104.8	114.8
0.64	103.3	77.2
0.68	104.6	43.7
0.73	106.6	18.0
0.77	107.3	6.1
0.82	106.4	357.5
0.86	103.3	348.0
0.91	96.9	313.4
0.95	98.6	232.8
1.00	103.7	211.6
1.05	105.9	204.9
1.09	105.7	199.0
1.14	103.5	192.3
1.18	98.1	167.3
1.23	97.9	90.6
1.27	103.4	60.1
1.32	106.1	51.6
1.36	106.7	48.0
1.41	105.4	42.7
1.45	101.6	28.6
1.50	95.7	330.5
1.55	101.6	266.4

Plane locations (w. r. t. streamwise location of
 liner x = 0.0)
 plane 1: -7.5 in.
 Plane 3: +16.0 in.
 Planes 2 and 4 are 0.3 in. behind planes 1 and 3,
 respectively.
 L = 11.0 in.
 w = 4.7 in.
 h = 2.0 in.

Liner
 M = 0.2
 T = 56 F

2500 Hz

source plane data

y/w	z/h	spl	phase	spl	phase
0.03	0.50	112.91	258.7	112.31	238.0
0.06	0.50	112.75	257.4	112.38	238.0
0.10	0.50	112.72	258.0	112.37	237.2
0.13	0.50	112.83	258.7	112.31	236.7
0.16	0.50	112.74	259.1	112.34	234.5
0.19	0.50	113.43	264.7	112.39	233.9
0.22	0.50	113.56	263.0	112.37	230.6
0.26	0.50	113.44	262.6	112.41	230.4
0.29	0.50	113.29	260.7	112.47	229.0
0.32	0.50	113.15	260.2	112.46	228.0
0.35	0.50	112.61	259.0	112.74	227.2
0.38	0.50	112.54	258.4	112.86	226.8
0.41	0.50	113.88	257.2	112.90	226.0
0.45	0.50	113.87	254.1	113.05	226.5
0.48	0.50	113.69	254.3	112.97	226.7
0.51	0.50	113.76	253.8	113.01	225.7
0.54	0.50	113.88	254.5	113.08	226.6
0.57	0.50	113.96	251.6	113.26	227.0
0.61	0.50	113.57	247.5	113.34	226.0
0.64	0.50	113.73	246.3	113.80	226.5
0.67	0.50	113.84	240.6	113.81	223.5
0.70	0.50	114.06	239.9	114.07	221.5
0.73	0.50	114.26	238.2	114.14	221.2
0.77	0.50	114.40	238.1	114.28	221.5
0.80	0.50	114.35	232.3	114.51	222.6
0.83	0.50	114.43	229.0	114.71	222.5
0.86	0.50	114.53	225.6	114.91	222.5
0.89	0.50	114.62	222.0	115.13	222.5
0.93	0.50	114.71	218.2	115.35	222.6
0.96	0.50	114.81	214.2	115.59	222.7
0.99	0.50	114.91	210.0	115.83	222.9

Exit Plane Data

		X3 Plane		X4 Plane	
y/w	z/h	spl	phase	spl	phase
0.03	0.50	96.00	30.0	98.45	351.5
0.06	0.50	95.92	29.1	98.43	350.6
0.10	0.50	95.70	33.1	98.94	354.2
0.13	0.50	95.00	32.2	98.00	0.0
0.16	0.50	95.19	36.6	98.27	357.2
0.19	0.50	95.35	36.8	98.12	357.1
0.22	0.50	95.27	33.5	98.28	355.4
0.26	0.50	94.86	35.6	98.09	357.3
0.29	0.50	94.70	36.7	98.28	356.2
0.32	0.50	94.73	36.7	98.16	354.9
0.35	0.50	94.54	37.7	98.35	353.2
0.38	0.50	94.53	37.7	98.27	351.9
0.41	0.50	94.32	38.8	98.17	354.7
0.45	0.50	94.65	38.2	98.30	352.4
0.48	0.50	94.25	36.8	98.49	351.2
0.51	0.50	94.34	36.5	98.38	351.1
0.54	0.50	93.99	27.5	98.38	351.3
0.57	0.50	94.11	26.8	98.28	350.0
0.61	0.50	94.08	31.7	98.44	349.1
0.64	0.50	94.32	34.0	98.68	348.6
0.67	0.50	94.75	29.8	99.85	348.0
0.70	0.50	94.59	29.9	100.04	344.1
0.73	0.50	93.96	29.3	100.07	346.7
0.77	0.50	94.04	30.6	100.16	345.2
0.80	0.50	94.34	25.7	100.44	342.3
0.83	0.50	94.39	24.0	100.76	340.9

0.86	0.50	94.45	22.3	101.09	339.3
0.89	0.50	94.53	20.5	101.45	337.7
0.93	0.50	94.61	18.5	101.82	336.0
0.96	0.50	94.70	16.5	102.21	334.2
0.99	0.50	94.80	14.3	102.63	332.3

Centerline Probe data

x/L	spl	phase
-0.86	112.9	13.9
-0.82	112.7	338.7
-0.77	113.4	306.1
-0.73	113.9	279.2
-0.68	113.8	253.8
-0.64	113.0	225.7
-0.59	112.8	193.3
-0.55	113.2	161.2
-0.50	113.7	134.8
-0.45	113.6	109.5
-0.41	112.9	82.8
-0.36	112.4	50.7
-0.32	112.4	18.4
-0.27	112.7	350.5
-0.23	112.2	322.6
-0.18	111.4	290.3
-0.14	111.5	252.9
-0.09	112.9	218.9
-0.05	114.2	193.3
0.00	115.1	172.2
0.05	115.2	152.3
0.09	114.9	131.4
0.14	114.3	108.9
0.18	113.7	83.9
0.23	113.3	58.7
0.27	112.9	34.6
0.32	112.3	13.8
0.36	111.4	351.1
0.41	110.3	327.5
0.45	109.4	299.1
0.50	108.9	270.6
0.55	108.9	246.4
0.59	108.5	225.7
0.64	107.4	206.2
0.68	105.6	186.5
0.73	103.6	150.5
0.77	103.5	110.7
0.82	104.8	83.5
0.86	105.6	67.2
0.91	104.9	54.1
0.95	102.6	40.1
1.00	99.7	12.9
1.05	98.5	334.1
1.09	98.6	308.2
1.14	96.3	287.2
1.18	89.8	244.3
1.23	93.6	154.3
1.27	99.1	132.3
1.32	101.1	124.5
1.36	100.3	116.5
1.41	97.3	95.5
1.45	94.3	36.5
1.50	98.4	351.1
1.55	100.9	328.7

Plane locations (w. r. t. streamwise location of
 liner $x = 0.0$)
 plane 1: -7.5 in.
 Plane 3: +16.0 in.
 Planes 2 and 4 are 0.3 in. behind planes 1 and 3,
 respectively.
 L = 11.0 in.
 w = 4.7 in.
 h = 2.0 in.

Liner
 M = 0.3
 T = 61 F

500 Hz

source plane data

y/w	z/h	spl phase	spl phase
0.03	0.50	109.13	136.8
0.06	0.50	106.99	156.2
0.10	0.50	106.10	149.7
0.13	0.50	107.56	156.0
0.16	0.50	107.97	150.4
0.19	0.50	107.76	148.0
0.22	0.50	101.85	201.0
0.26	0.50	102.80	199.6
0.29	0.50	104.65	189.3
0.32	0.50	104.59	185.2
0.35	0.50	103.23	184.1
0.38	0.50	101.33	188.0
0.41	0.50	102.37	184.7
0.45	0.50	107.08	148.2
0.48	0.50	107.87	134.8
0.51	0.50	107.57	144.5
0.54	0.50	107.25	156.3
0.57	0.50	107.40	132.9
0.61	0.50	108.35	134.6
0.64	0.50	109.25	144.0
0.67	0.50	108.64	138.2
0.70	0.50	109.11	143.4
0.73	0.50	109.11	143.1
0.77	0.50	108.59	139.7
0.80	0.50	109.09	144.9
0.83	0.50	109.23	147.5
0.86	0.50	109.36	150.7
0.89	0.50	109.48	154.6
0.93	0.50	109.61	160.9
0.96	0.50	109.69	166.6
0.99	0.50	109.76	173.2

Exit Plane Data

		X3 Plane	X4 Plane
y/w	z/h	spl phase	spl phase
0.03	0.50	104.57	158.8
0.06	0.50	106.48	164.4
0.10	0.50	104.72	161.5
0.13	0.50	104.00	155.7
0.16	0.50	103.36	163.5
0.19	0.50	103.23	161.8
0.22	0.50	104.58	166.0
0.26	0.50	103.45	163.6
0.29	0.50	104.49	164.9
0.32	0.50	104.07	161.7
0.35	0.50	104.07	157.1
0.38	0.50	104.39	157.7
0.41	0.50	103.94	156.5
0.45	0.50	103.03	147.1
0.48	0.50	103.25	150.3
0.51	0.50	104.54	142.6
0.54	0.50	104.24	156.3
0.57	0.50	103.30	154.2
0.61	0.50	104.18	147.2
0.64	0.50	105.77	161.4
0.67	0.50	107.47	165.2
0.70	0.50	109.06	156.6
0.73	0.50	108.67	151.9
0.77	0.50	108.86	163.3
0.80	0.50	109.79	158.2

0.83	0.50	110.69	158.9
0.86	0.50	111.64	159.7
0.89	0.50	112.65	160.6
0.93	0.50	113.72	161.5
0.96	0.50	114.84	162.6
0.99	0.50	116.03	163.7

Centerline Probe data

x/L	spl phase
-0.86	108.2
-0.82	106.6
-0.77	108.0
-0.73	106.4
-0.68	107.6
-0.64	108.7
-0.59	109.2
-0.55	110.1
-0.50	111.0
-0.45	111.3
-0.41	111.3
-0.36	110.7
-0.32	110.8
-0.27	109.4
-0.23	109.2
-0.18	108.6
-0.14	105.5
-0.09	104.0
-0.05	103.0
0.00	102.4
0.05	99.8
0.09	99.7
0.14	99.2
0.18	100.9
0.23	100.9
0.27	101.3
0.32	100.2
0.36	101.5
0.41	99.2
0.45	99.8
0.50	99.6
0.55	97.4
0.59	99.8
0.64	101.3
0.68	101.9
0.73	102.1
0.77	103.1
0.82	103.3
0.86	103.5
0.91	103.5
0.95	102.6
1.00	100.3
1.05	99.5
1.09	96.5
1.14	89.8
1.18	87.7
1.23	84.4
1.27	92.4
1.32	92.4
1.36	96.6
1.41	101.0
1.45	104.5
1.50	107.0
1.55	107.4

Plane locations (w. r. t. streamwise location of
 liner $x = 0.0$)
 plane 1: -7.5 in.
 Plane 3: +16.0 in.
 Planes 2 and 4 are 0.3 in. behind planes 1 and 3,
 respectively.
 L = 11.0 in.
 w = 4.7 in.
 h = 2.0 in.

Liner
 M = 0.3
 T = 61 F

1000 Hz

source plane data

y/w	z/h	spl	phase	spl	phase
0.03	0.50	111.59	343.4	112.58	351.9
0.06	0.50	111.23	350.5	112.65	355.0
0.10	0.50	111.42	349.9	112.68	353.9
0.13	0.50	111.22	344.3	112.68	349.4
0.16	0.50	111.71	347.7	112.54	351.9
0.19	0.50	111.42	346.8	112.67	354.6
0.22	0.50	113.85	13.1	113.05	348.5
0.26	0.50	113.31	8.2	112.81	346.9
0.29	0.50	113.01	5.0	112.66	347.4
0.32	0.50	112.94	4.3	112.61	349.3
0.35	0.50	111.30	8.7	112.99	347.9
0.38	0.50	111.29	15.8	112.53	349.8
0.41	0.50	112.07	15.3	112.92	346.3
0.45	0.50	112.03	349.1	111.61	349.0
0.48	0.50	111.90	350.6	112.40	351.8
0.51	0.50	111.53	351.2	111.74	350.7
0.54	0.50	112.59	351.1	112.53	356.3
0.57	0.50	111.86	347.2	112.71	359.4
0.61	0.50	112.10	349.3	113.47	3.5
0.64	0.50	112.45	353.8	114.62	10.0
0.67	0.50	112.62	343.2	113.26	348.0
0.70	0.50	112.62	344.3	112.52	346.8
0.73	0.50	112.43	339.6	112.56	349.3
0.77	0.50	113.15	352.6	112.84	346.8
0.80	0.50	112.54	344.8	113.14	163.6
0.83	0.50	112.56	344.1	113.20	138.2
0.86	0.50	112.58	343.2	113.28	110.6
0.89	0.50	112.59	342.3	113.35	80.6
0.93	0.50	112.61	341.0	113.43	48.4
0.96	0.50	112.62	340.0	113.51	13.9
0.99	0.50	112.63	338.9	113.60	337.0

Exit Plane Data

		X3 Plane	X4 Plane		
y/w	z/h	spl phase	spl phase		
0.03	0.50	100.07	265.9	103.69	251.9
0.06	0.50	99.47	262.7	102.99	242.2
0.10	0.50	99.88	261.3	102.46	235.1
0.13	0.50	99.73	271.8	100.59	239.4
0.16	0.50	96.44	273.2	100.48	261.7
0.19	0.50	99.25	257.3	101.78	264.8
0.22	0.50	98.65	250.2	102.24	256.4
0.26	0.50	98.66	245.8	102.84	271.0
0.29	0.50	99.10	258.1	102.97	247.1
0.32	0.50	98.15	260.7	102.96	260.9
0.35	0.50	99.75	264.2	104.29	257.0
0.38	0.50	98.55	248.3	102.43	252.5
0.41	0.50	98.95	262.8	104.02	251.3
0.45	0.50	99.89	254.4	104.64	250.2
0.48	0.50	100.47	253.1	102.79	255.3
0.51	0.50	99.09	250.6	99.86	252.2
0.54	0.50	98.64	247.4	105.83	256.2
0.57	0.50	100.14	250.7	105.14	237.3
0.61	0.50	100.37	253.7	104.10	257.7
0.64	0.50	100.60	257.4	105.42	257.3
0.67	0.50	101.61	232.9	107.75	251.0
0.70	0.50	102.43	264.0	110.84	251.9
0.73	0.50	103.13	240.5	108.90	247.9
0.77	0.50	103.50	253.9	108.87	253.2
0.80	0.50	104.00	249.4	110.56	246.6

0.83	0.50	104.69	249.3	111.54	245.0
0.86	0.50	105.43	249.3	112.57	243.3
0.89	0.50	106.21	249.3	113.65	241.5
0.93	0.50	107.04	249.4	114.78	239.6
0.96	0.50	107.90	249.6	115.97	237.5
0.99	0.50	108.81	249.8	117.21	235.3

Centerline Probe data

x/L	spl	phase
-0.86	106.8	9.7
-0.82	108.5	0.2
-0.77	110.4	356.9
-0.73	110.9	354.4
-0.68	111.5	351.2
-0.64	111.7	350.7
-0.59	111.2	342.5
-0.55	109.8	338.6
-0.50	108.8	334.9
-0.45	106.4	332.2
-0.41	104.5	303.8
-0.36	103.4	279.8
-0.32	105.0	255.3
-0.27	107.6	236.4
-0.23	109.2	226.8
-0.18	110.6	221.1
-0.14	111.3	216.2
-0.09	111.7	213.7
-0.05	111.5	212.5
0.00	110.8	209.2
0.05	110.3	205.2
0.09	109.9	199.9
0.14	109.2	192.0
0.18	108.5	183.8
0.23	107.4	177.1
0.27	106.3	168.1
0.32	105.7	160.3
0.36	105.0	151.9
0.41	104.5	147.4
0.45	103.6	138.6
0.50	103.5	127.1
0.55	102.4	119.9
0.59	101.0	107.8
0.64	101.4	99.9
0.68	100.6	90.3
0.73	101.2	76.2
0.77	99.3	67.0
0.82	99.3	60.4
0.86	100.3	53.4
0.91	100.3	45.5
0.95	99.8	40.7
1.00	99.5	41.4
1.05	98.6	40.9
1.09	96.7	37.0
1.14	94.2	34.4
1.18	89.3	47.4
1.23	88.3	64.1
1.27	83.9	219.6
1.32	90.6	240.8
1.36	95.4	238.2
1.41	97.1	235.8
1.45	99.1	250.6
1.50	99.9	252.2
1.55	100.8	246.4

Plane locations (w. r. t. streamwise location of
 liner $x = 0.0$)
 plane 1: -7.5 in.
 Plane 3: +16.0 in.
 Planes 2 and 4 are 0.3 in. behind planes 1 and 3,
 respectively.
 L = 11.0 in.
 w = 4.7 in.
 h = 2.0 in.

Liner
 M = 0.3
 T = 61 F

1500 Hz

source plane data

y/w	z/h	spl phase	spl phase
0.03	0.50	112.02	254.7
0.06	0.50	111.73	253.3
0.10	0.50	112.25	251.1
0.13	0.50	111.96	248.4
0.16	0.50	112.05	247.8
0.19	0.50	112.23	247.1
0.22	0.50	112.87	254.1
0.26	0.50	112.26	256.1
0.29	0.50	112.38	251.6
0.32	0.50	112.29	244.4
0.35	0.50	111.41	242.7
0.38	0.50	112.12	240.0
0.41	0.50	112.76	241.9
0.45	0.50	112.71	223.0
0.48	0.50	112.97	215.5
0.51	0.50	112.76	216.4
0.54	0.50	113.45	214.4
0.57	0.50	113.78	212.2
0.61	0.50	113.57	205.0
0.64	0.50	114.47	204.3
0.67	0.50	114.33	195.5
0.70	0.50	114.23	193.1
0.73	0.50	114.74	194.6
0.77	0.50	114.84	191.2
0.80	0.50	115.33	177.7
0.83	0.50	115.65	171.6
0.86	0.50	115.99	165.3
0.89	0.50	116.34	158.7
0.93	0.50	116.71	151.9
0.96	0.50	117.09	144.9
0.99	0.50	117.49	137.7

Exit Plane Data

		X3 Plane	X4 Plane
y/w	z/h	spl phase	spl phase
0.03	0.50	113.67	200.7
0.06	0.50	113.38	199.9
0.10	0.50	113.12	198.3
0.13	0.50	112.82	201.2
0.16	0.50	113.24	196.9
0.19	0.50	113.44	199.4
0.22	0.50	112.98	196.3
0.26	0.50	113.07	196.6
0.29	0.50	113.20	199.5
0.32	0.50	113.24	196.7
0.35	0.50	113.29	197.0
0.38	0.50	113.28	196.1
0.41	0.50	113.53	196.8
0.45	0.50	113.62	196.4
0.48	0.50	113.68	195.5
0.51	0.50	113.83	196.2
0.54	0.50	113.97	196.0
0.57	0.50	113.97	196.5
0.61	0.50	114.43	195.5
0.64	0.50	116.51	190.5
0.67	0.50	117.04	187.8
0.70	0.50	118.31	186.3
0.73	0.50	117.75	188.1
0.77	0.50	117.08	189.9
0.80	0.50	118.74	186.7

0.83	0.50	119.44	185.6
0.86	0.50	120.17	184.4
0.89	0.50	120.95	183.2
0.93	0.50	121.77	181.9
0.96	0.50	122.63	180.5
0.99	0.50	123.52	179.2

Centerline Probe data

x/L	spl phase
-0.86	115.2
-0.82	115.0
-0.77	114.4
-0.73	113.4
-0.68	112.8
-0.64	113.1
-0.59	114.2
-0.55	115.3
-0.50	115.8
-0.45	115.5
-0.41	115.0
-0.36	113.9
-0.32	112.6
-0.27	112.1
-0.23	113.0
-0.18	113.7
-0.14	114.5
-0.09	114.6
-0.05	114.5
0.00	113.7
0.05	112.6
0.09	112.2
0.14	113.1
0.18	113.8
0.23	114.4
0.27	114.6
0.32	113.8
0.36	112.5
0.41	110.5
0.45	108.4
0.50	108.2
0.55	110.6
0.59	112.3
0.64	113.8
0.68	113.8
0.73	113.1
0.77	111.4
0.82	108.0
0.86	103.0
0.91	104.2
0.95	109.0
1.00	111.7
1.05	113.5
1.09	113.6
1.14	112.2
1.18	109.6
1.23	104.2
1.27	99.2
1.32	106.8
1.36	111.1
1.41	113.1
1.45	113.8
1.50	112.8
1.55	110.7

Plane locations (w. r. t. streamwise location of
 liner $x = 0.0$)
 plane 1: -7.5 in.
 Plane 3: +16.0 in.
 Planes 2 and 4 are 0.3 in. behind planes 1 and 3,
 respectively.
 L = 11.0 in.
 w = 4.7 in.
 h = 2.0 in.

Liner
 M = 0.3
 T = 61 F

2000 Hz

source plane data

y/w	z/h	spl	phase	spl	phase
0.03	0.50	110.38	66.0	111.23	45.8
0.06	0.50	110.10	63.1	111.77	41.6
0.10	0.50	110.30	63.5	111.09	41.0
0.13	0.50	110.27	62.3	111.25	40.8
0.16	0.50	110.03	63.0	111.25	40.7
0.19	0.50	110.12	65.1	111.52	41.0
0.22	0.50	109.79	68.2	111.32	43.0
0.26	0.50	110.12	68.5	111.41	43.0
0.29	0.50	109.77	72.4	111.22	41.5
0.32	0.50	109.73	74.1	111.30	43.5
0.35	0.50	109.23	75.2	111.42	46.5
0.38	0.50	109.51	73.4	111.22	48.7
0.41	0.50	109.47	73.3	111.43	51.2
0.45	0.50	110.41	73.2	111.70	52.3
0.48	0.50	110.51	73.5	111.64	55.9
0.51	0.50	110.96	75.9	111.65	58.6
0.54	0.50	110.93	76.1	111.51	59.6
0.57	0.50	111.15	76.4	111.80	61.3
0.61	0.50	111.07	76.6	111.94	64.5
0.64	0.50	111.19	79.7	112.28	66.6
0.67	0.50	111.42	78.1	112.37	65.7
0.70	0.50	111.55	78.1	112.60	66.2
0.73	0.50	111.92	77.8	112.73	67.7
0.77	0.50	111.98	79.7	112.64	68.1
0.80	0.50	112.57	79.5	112.97	75.1
0.83	0.50	112.91	79.7	113.17	77.8
0.86	0.50	113.27	79.9	113.38	80.6
0.89	0.50	113.64	80.1	113.59	83.4
0.93	0.50	114.04	80.2	113.82	86.4
0.96	0.50	114.45	80.3	114.06	89.5
0.99	0.50	114.89	80.3	114.30	92.7

Exit Plane Data

		X3 Plane	X4 Plane		
y/w	z/h	spl phase	spl phase		
0.03	0.50	101.95	149.9	99.13	93.3
0.06	0.50	103.38	155.8	97.51	121.0
0.10	0.50	103.83	153.4	98.39	112.7
0.13	0.50	103.55	142.9	99.49	110.1
0.16	0.50	102.02	147.1	98.97	111.9
0.19	0.50	102.52	154.9	98.71	100.2
0.22	0.50	101.56	149.4	97.28	107.0
0.26	0.50	103.05	155.7	98.58	109.2
0.29	0.50	103.41	150.1	96.67	114.8
0.32	0.50	103.56	149.3	97.41	106.2
0.35	0.50	103.38	148.7	98.74	104.7
0.38	0.50	103.89	144.9	100.56	110.3
0.41	0.50	104.29	147.9	97.10	106.2
0.45	0.50	104.64	150.8	99.26	128.8
0.48	0.50	103.86	144.3	99.97	109.4
0.51	0.50	104.38	147.7	99.04	130.5
0.54	0.50	104.63	148.2	101.97	125.4
0.57	0.50	105.10	144.5	99.09	111.3
0.61	0.50	105.92	145.8	101.12	110.8
0.64	0.50	108.29	139.9	100.97	107.8
0.67	0.50	108.76	136.4	105.27	100.9
0.70	0.50	110.32	135.4	106.90	96.3
0.73	0.50	109.34	131.1	105.03	115.0
0.77	0.50	107.97	134.3	103.94	108.6
0.80	0.50	107.70	130.6	104.26	105.0

0.83	0.50	108.20	128.4	104.91	103.5
0.86	0.50	108.59	126.0	105.60	101.9
0.89	0.50	109.24	123.6	106.32	100.2
0.93	0.50	109.68	121.0	107.34	98.3
0.96	0.50	110.17	118.3	108.13	96.3
0.99	0.50	110.68	115.5	108.97	94.2

Centerline Probe data

x/L	spl	phase
-0.86	111.2	173.0
-0.82	110.8	151.1
-0.77	109.9	126.3
-0.73	110.3	98.8
-0.68	111.0	75.9
-0.64	111.7	58.6
-0.59	111.8	41.7
-0.55	111.2	22.9
-0.50	110.4	2.2
-0.45	109.9	334.1
-0.41	110.5	309.8
-0.36	111.2	289.8
-0.32	111.3	271.4
-0.27	110.8	253.6
-0.23	109.9	231.4
-0.18	109.5	201.9
-0.14	110.1	173.8
-0.09	111.6	152.7
-0.05	112.3	137.7
0.00	112.4	123.4
0.05	111.7	109.8
0.09	110.6	92.8
0.14	109.3	69.8
0.18	108.7	45.2
0.23	108.4	23.8
0.27	108.1	5.6
0.32	107.4	346.9
0.36	105.6	324.0
0.41	104.8	294.8
0.45	105.5	261.4
0.50	106.7	238.1
0.55	106.8	227.9
0.59	105.6	214.1
0.64	103.2	193.3
0.68	100.9	155.6
0.73	102.8	109.2
0.77	105.7	93.7
0.82	107.1	89.4
0.86	105.9	89.2
0.91	102.7	91.5
0.95	90.9	83.4
1.00	96.8	283.3
1.05	103.7	281.8
1.09	106.2	284.1
1.14	106.0	289.3
1.18	103.7	289.0
1.23	98.2	269.5
1.27	97.3	176.5
1.32	103.8	157.5
1.36	105.8	155.1
1.41	106.5	152.7
1.45	104.4	147.7
1.50	99.0	130.5
1.55	96.1	48.6

Plane locations (w. r. t. streamwise location of
 liner $x = 0.0$)
 plane 1: -7.5 in.
 Plane 3: +16.0 in.
 Planes 2 and 4 are 0.3 in. behind planes 1 and 3,
 respectively.
 L = 11.0 in.
 w = 4.7 in.
 h = 2.0 in.

Liner
 M = 0.3
 T = 61 F

2500 Hz

source plane data

y/w	z/h	spl	phase	spl	phase
0.03	0.50	109.08	330.4	108.01	311.5
0.06	0.50	108.48	330.4	107.90	300.4
0.10	0.50	109.18	327.3	107.93	302.1
0.13	0.50	108.04	329.6	107.47	300.7
0.16	0.50	109.04	327.7	108.08	301.8
0.19	0.50	108.96	327.2	108.22	299.0
0.22	0.50	109.85	336.3	108.18	297.1
0.26	0.50	109.44	334.1	108.54	296.4
0.29	0.50	110.02	332.2	108.26	296.3
0.32	0.50	109.88	333.9	108.61	296.9
0.35	0.50	109.51	333.2	109.10	299.6
0.38	0.50	109.34	335.3	109.36	300.6
0.41	0.50	109.94	333.4	109.65	298.3
0.45	0.50	110.17	326.7	109.94	298.4
0.48	0.50	110.41	323.2	109.91	301.4
0.51	0.50	110.64	324.2	110.09	300.5
0.54	0.50	110.86	324.3	110.43	301.6
0.57	0.50	111.29	321.8	110.42	303.0
0.61	0.50	111.54	320.4	110.98	301.4
0.64	0.50	111.63	318.2	111.78	303.8
0.67	0.50	112.04	314.8	111.79	303.2
0.70	0.50	112.52	315.2	112.15	302.1
0.73	0.50	112.66	313.2	112.19	301.3
0.77	0.50	113.09	316.1	112.66	300.4
0.80	0.50	113.39	308.1	113.18	305.4
0.83	0.50	113.76	305.3	113.59	306.4
0.86	0.50	114.15	302.3	114.01	307.6
0.89	0.50	114.55	299.2	114.45	308.9

0.93	0.50	114.96	296.0	114.90	310.2
0.96	0.50	115.39	292.6	115.36	311.6
0.99	0.50	115.83	289.0	115.84	313.1

Exit Plane Data

y/w	z/h	X3 Plane		X4 Plane	
		spl	phase	spl	phase
0.03	0.50	99.92	229.7	98.24	149.3
0.06	0.50	103.39	224.9	97.70	165.5
0.10	0.50	102.24	219.4	98.87	148.8
0.13	0.50	100.65	241.1	97.41	161.4
0.16	0.50	100.27	219.1	96.68	167.4
0.19	0.50	99.98	231.5	96.29	151.3
0.22	0.50	98.07	228.1	97.91	149.8
0.26	0.50	98.56	212.0	92.87	159.9
0.29	0.50	98.56	217.6	93.13	142.1
0.32	0.50	97.80	223.0	95.70	159.0
0.35	0.50	95.10	223.8	94.09	160.1
0.38	0.50	97.70	238.5	94.88	152.2
0.41	0.50	96.04	229.5	94.90	151.4
0.45	0.50	95.68	248.6	95.18	168.3
0.48	0.50	97.20	229.5	94.44	165.2
0.51	0.50	93.06	230.5	93.63	152.8
0.54	0.50	92.50	226.4	96.18	154.4
0.57	0.50	93.57	237.2	93.95	165.7
0.61	0.50	95.82	262.5	94.49	156.4
0.64	0.50	98.19	235.8	96.58	122.0
0.67	0.50	99.95	239.1	100.06	118.3
0.70	0.50	99.48	239.5	96.05	129.0
0.73	0.50	97.74	209.6	99.13	139.8
0.77	0.50	101.24	203.6	98.47	131.8
0.80	0.50	100.30	223.7	99.89	123.5
0.83	0.50	101.14	221.9	100.80	119.0
0.86	0.50	102.05	220.0	101.79	114.3
0.89	0.50	103.03	217.9	102.85	109.2
0.93	0.50	104.46	215.7	103.97	104.0
0.96	0.50	105.61	213.3	105.17	98.4
0.99	0.50	106.83	210.8	106.44	92.6

Centerline Probe data

x/L	spl	phase
-0.86	109.8	75.8
-0.82	109.0	43.8
-0.77	109.4	12.8
-0.73	110.4	345.2
-0.68	110.6	324.2
-0.64	110.1	300.5
-0.59	109.8	270.1
-0.55	109.9	243.4

-0.50	110.2	217.7
-0.45	110.3	196.1
-0.41	109.6	168.8
-0.36	109.0	140.6
-0.32	109.1	112.5
-0.27	109.0	87.6
-0.23	108.3	62.6
-0.18	107.6	28.5
-0.14	108.1	352.5
-0.09	109.2	322.8
-0.05	110.5	301.2
0.00	111.1	279.9
0.05	111.5	260.4
0.09	111.5	239.8
0.14	111.5	220.9
0.18	110.6	201.7
0.23	109.5	181.6
0.27	108.5	157.1
0.32	108.1	130.3
0.36	108.2	107.1
0.41	107.9	88.1
0.45	107.0	71.6
0.50	105.5	48.8
0.55	103.8	17.4
0.59	104.5	346.0
0.64	105.7	325.2
0.68	105.2	312.8
0.73	102.9	299.3
0.77	98.8	266.7
0.82	98.9	208.1
0.86	103.0	183.1
0.91	104.2	181.0
0.95	103.5	178.3
1.00	100.2	178.9
1.05	92.4	168.2
1.09	86.3	55.8
1.14	94.3	32.9
1.18	93.9	14.3
1.23	90.9	329.5
1.27	93.8	282.0
1.32	98.6	261.9
1.36	99.8	259.9
1.41	98.5	250.8
1.45	93.1	230.5
1.50	93.6	152.8
1.55	98.5	122.4

Hard wall

M = 0.1

T = 68 F

Upstream Velocity Profile

Y/Ymax	Vel (ft/s)	U/Umax
0.042553	108.76	0.92048
0.074468	110.00	0.93097
0.10638	110.53	0.93546
0.13830	108.47	0.91796
0.17021	113.02	0.95648
0.20213	113.25	0.95842
0.23404	116.56	0.98648
0.26596	117.78	0.99678
0.29787	113.76	0.96275
0.32979	114.66	0.97041
0.36170	115.90	0.98084
0.39362	113.93	0.96418
0.42553	113.82	0.96323
0.45745	113.24	0.95840
0.48936	115.34	0.97611
0.52128	113.87	0.96369
0.55319	118.16	0.99997
0.58511	114.27	0.96705
0.61702	117.55	0.99488
0.64894	114.95	0.97279
0.68085	118.10	0.99953
0.71277	115.62	0.97847
0.74468	117.33	0.99301
0.77660	117.33	0.99302
0.80851	117.67	0.99582
0.84043	116.01	0.98177
0.87234	117.22	0.99208
0.90426	118.16	0.99998

Downstream Velocity Profile

Y/Ymax	Vel (ft/s)	U/Umax
0.042553	111.87	0.94030
0.074468	111.81	0.93982
0.10638	114.72	0.96426
0.13830	116.95	0.98300
0.17021	117.50	0.98763
0.20213	117.83	0.99041
0.23404	117.11	0.98440
0.26596	116.51	0.97929
0.29787	116.39	0.97834
0.32979	117.72	0.98949
0.36170	117.39	0.98671
0.39362	115.84	0.97368
0.42553	116.56	0.97975
0.45745	116.84	0.98207
0.48936	115.22	0.96850
0.52128	117.11	0.98440
0.55319	117.39	0.98671
0.58511	118.97	1.0000
0.61702	117.99	0.99178
0.64894	116.17	0.97648
0.68085	118.05	0.99225
0.71277	116.39	0.97834
0.74468	118.38	0.99500
0.77660	118.76	0.99820
0.80851	117.61	0.98856
0.84043	117.99	0.99178
0.87234	118.43	0.99546
0.90426	117.44	0.98717

Hard wall
M = 0.2
T = 46 F

Upstream Velocity Profile

Y/Ymax	Velocity (ft/s)	U/Umax
0.042553	247.83	0.99922
0.074468	248.02	0.99998
0.10638	246.29	0.99301
0.13830	245.94	0.99161
0.17021	246.10	0.99227
0.20213	245.71	0.99069
0.23404	245.27	0.98891
0.26596	245.49	0.98981
0.29787	245.31	0.98907
0.32979	244.51	0.98587
0.36170	244.59	0.98616
0.39362	244.33	0.98512
0.42553	244.66	0.98645
0.45745	244.48	0.98572
0.48936	244.32	0.98509
0.52128	243.99	0.98375
0.55319	238.87	0.96310
0.58511	239.10	0.96404
0.61702	240.77	0.97077
0.64894	239.41	0.96529
0.68085	238.71	0.96247
0.71277	238.03	0.95974
0.74468	238.53	0.96174
0.77660	238.77	0.96270
0.80851	237.91	0.95924
0.84043	239.62	0.96612
0.87234	238.60	0.96203
0.90426	239.10	0.96403

Downstream Velocity Profile

Y/Ymax	Velocity	U/Umax
0.042553	243.08	0.98733
0.074468	246.35	1.0006
0.10638	244.03	0.99118
0.13830	247.52	1.0053
0.17021	245.99	0.99917
0.20213	244.85	0.99451
0.23404	244.37	0.99255
0.26596	244.54	0.99326
0.29787	244.49	0.99304
0.32979	248.54	1.0095
0.36170	244.58	0.99342
0.39362	243.96	0.99089
0.42553	242.41	0.98460
0.45745	244.83	0.99442
0.48936	243.23	0.98793
0.52128	243.50	0.98904
0.55319	240.50	0.97684
0.58511	246.23	1.0001
0.61702	240.88	0.97839
0.64894	228.06	0.92632
0.68085	240.95	0.97866
0.71277	242.55	0.98517
0.74468	243.83	0.99036
0.77660	244.24	0.99204
0.80851	243.95	0.99087
0.84043	244.43	0.99283
0.87234	236.89	0.96218
0.90426	245.96	0.99904

Hard wall
M = 0.3
T = 45 F

Upstream Velocity Profile

Y/Ymax	Vel. (ft/s)	U/Umax
0.042553	332.65	0.99244
0.074468	332.80	0.99290
0.10638	331.96	0.99041
0.13830	331.13	0.98793
0.17021	330.76	0.98680
0.20213	330.59	0.98631
0.23404	331.05	0.98769
0.26596	330.82	0.98700
0.29787	328.37	0.97968
0.32979	330.70	0.98663
0.36170	331.91	0.99024
0.39362	331.12	0.98789
0.42553	330.13	0.98494
0.45745	330.25	0.98528
0.48936	330.90	0.98724
0.52128	330.61	0.98636
0.55319	330.08	0.98479
0.58511	329.96	0.98442
0.61702	329.69	0.98362
0.64894	329.58	0.98329
0.68085	330.52	0.98609
0.71277	330.71	0.98665
0.74468	329.62	0.98340
0.77660	329.21	0.98218
0.80851	331.84	0.99005
0.84043	332.38	0.99164
0.87234	333.17	0.99400
0.90426	335.18	0.99999

Downstream Velocity Profile

Y/Ymax	Vel. (ft/s)	U/Umax
0.042553	342.51	0.99821
0.074468	341.96	0.99663
0.10638	343.12	1.0000
0.13830	341.90	0.99645
0.17021	342.69	0.99875
0.20213	342.74	0.99889
0.23404	338.33	0.98603
0.26596	340.45	0.99223
0.29787	339.82	0.99039
0.32979	339.47	0.98936
0.36170	341.26	0.99457
0.39362	337.90	0.98478
0.42553	340.25	0.99164
0.45745	337.60	0.98390
0.48936	340.52	0.99242
0.52128	338.66	0.98699
0.55319	340.29	0.99176
0.58511	338.64	0.98694
0.61702	337.77	0.98441
0.64894	338.87	0.98761
0.68085	338.26	0.98584
0.71277	338.73	0.98721
0.74468	338.49	0.98651
0.77660	338.04	0.98519
0.80851	338.41	0.98629
0.84043	337.74	0.98431
0.87234	337.12	0.98250
0.90426	337.02	0.98223

Liner
M = 0.1

Upstream Velocity Profile

y	z	M	U	U/Umax
0.89362	0.0000	0.10790	121.05	0.93585
0.87234	0.0000	0.10920	122.23	0.94712
0.85106	0.0000	0.10930	122.40	0.94799
0.82979	0.0000	0.10970	123.36	0.95146
0.80851	0.0000	0.10910	122.10	0.94625
0.78723	0.0000	0.11120	124.39	0.96447
0.76596	0.0000	0.11190	125.15	0.97054
0.74468	0.0000	0.11460	127.38	0.99396
0.72340	0.0000	0.11340	126.95	0.98355
0.70213	0.0000	0.11400	127.50	0.98875
0.68085	0.0000	0.11460	128.26	0.99396
0.65957	0.0000	0.11410	127.73	0.98962
0.63830	0.0000	0.11400	127.50	0.98875
0.61702	0.0000	0.11490	128.60	0.99656
0.59574	0.0000	0.11450	128.26	0.99309
0.57447	0.0000	0.11430	127.97	0.99136
0.55319	0.0000	0.11530	128.85	1.0000
0.53191	0.0000	0.11450	128.04	0.99309
0.51064	0.0000	0.11410	127.73	0.98962
0.48936	0.0000	0.11450	127.71	0.99309
0.46809	0.0000	0.11400	127.51	0.98875
0.44681	0.0000	0.11460	127.91	0.99396
0.42553	0.0000	0.11460	128.22	0.99396
0.40426	0.0000	0.11430	127.96	0.99136
0.38298	0.0000	0.11530	129.34	1.0000
0.36170	0.0000	0.11400	127.62	0.98875
0.34043	0.0000	0.11420	127.60	0.99049
0.31915	0.0000	0.11510	128.20	0.99829
0.29787	0.0000	0.11420	127.44	0.99049
0.27660	0.0000	0.11420	127.73	0.99049
0.25532	0.0000	0.11250	125.82	0.97574
0.23404	0.0000	0.11090	124.69	0.96187
0.21277	0.0000	0.11110	123.87	0.96360
0.19149	0.0000	0.10880	121.78	0.94365
0.17021	0.0000	0.10850	121.36	0.94105
0.14894	0.0000	0.10820	121.11	0.93845
0.12766	0.0000	0.10800	120.66	0.93671
0.10638	0.0000	0.10740	119.95	0.93151
0.085106	0.0000	0.10760	120.43	0.93324
0.063830	0.0000	0.10330	115.64	0.89595
0.042553	0.0000	0.10050	112.27	0.87166

Downstream Velocity profile

y/w	z	M	U	U/Umax
0.91489	0.0000	0.096300	108.97	0.84697
0.89362	0.0000	0.10410	117.80	0.91557
0.87234	0.0000	0.10400	117.68	0.91469
0.85106	0.0000	0.10970	124.13	0.96483
0.82979	0.0000	0.11020	124.70	0.96922
0.80851	0.0000	0.11190	126.62	0.98418
0.78723	0.0000	0.11060	125.15	0.97274
0.76596	0.0000	0.11190	126.62	0.98418
0.74468	0.0000	0.11230	127.08	0.98769
0.72340	0.0000	0.11090	125.49	0.97538
0.70213	0.0000	0.11080	125.38	0.97450
0.68085	0.0000	0.11370	128.66	1.0000
0.65957	0.0000	0.11260	127.42	0.99033
0.63830	0.0000	0.11080	125.38	0.97450
0.61702	0.0000	0.11110	125.72	0.97714
0.59574	0.0000	0.11320	128.10	0.99561
0.57447	0.0000	0.11070	125.27	0.97362
0.55319	0.0000	0.11430	129.34	1.0053
0.53191	0.0000	0.11280	127.64	0.99209
0.51064	0.0000	0.11240	127.19	0.98857
0.48936	0.0000	0.11280	127.64	0.99209
0.46809	0.0000	0.10960	124.02	0.96395
0.44681	0.0000	0.11110	125.72	0.97714
0.42553	0.0000	0.11110	125.72	0.97714

0.40426	0.0000	0.11040	124.93	0.97098
0.38298	0.0000	0.11310	127.98	0.99473
0.36170	0.0000	0.11160	126.28	0.98154
0.34043	0.0000	0.11190	126.62	0.98418
0.31915	0.0000	0.11120	125.83	0.97802
0.29787	0.0000	0.11050	125.04	0.97186
0.27660	0.0000	0.11000	124.47	0.96747
0.25532	0.0000	0.11270	127.53	0.99121
0.23404	0.0000	0.11420	129.23	1.0044
0.21277	0.0000	0.11180	126.51	0.98330
0.19149	0.0000	0.10910	123.46	0.95955
0.17021	0.0000	0.10740	121.53	0.94460
0.14894	0.0000	0.10270	116.21	0.90326
0.12766	0.0000	0.10400	117.68	0.91469
0.10638	0.0000	0.10220	115.65	0.89886
0.085106	0.0000	0.097300	110.10	0.85577
0.063830	0.0000	0.090900	102.86	0.79948

Liner
M = 0.2

Upstream Velocity profile

y/w	z	M	U	U/Umax
0.68085	0.0000	0.19970	222.32	0.98037
0.65957	0.0000	0.19970	221.33	0.98037
0.63830	0.0000	0.20100	223.78	0.98676
0.61702	0.0000	0.20030	222.84	0.98332
0.59574	0.0000	0.20100	223.33	0.98676
0.57447	0.0000	0.20130	223.66	0.98823
0.55319	0.0000	0.20160	223.44	0.98970
0.53191	0.0000	0.20270	225.01	0.99510
0.51064	0.0000	0.20210	224.17	0.99216
0.48936	0.0000	0.20370	226.37	1.0000
0.46809	0.0000	0.20200	224.92	0.99166
0.44681	0.0000	0.20030	223.04	0.98332
0.42553	0.0000	0.20150	223.99	0.98921
0.40426	0.0000	0.20050	223.33	0.98430
0.38298	0.0000	0.19960	221.65	0.97988
0.36170	0.0000	0.19870	220.78	0.97546
0.34043	0.0000	0.19780	220.27	0.97105
0.31915	0.0000	0.19720	219.30	0.96810
0.29787	0.0000	0.19710	219.61	0.96761
0.27660	0.0000	0.19760	219.72	0.97006
0.25532	0.0000	0.19750	219.07	0.96957
0.23404	0.0000	0.19590	218.67	0.96172
0.21277	0.0000	0.19410	216.02	0.95288
0.19149	0.0000	0.19450	216.67	0.95485
0.17021	0.0000	0.19540	217.40	0.95926
0.14894	0.0000	0.19230	213.76	0.94404
0.12766	0.0000	0.19140	213.09	0.93963
0.10638	0.0000	0.19080	212.38	0.93668
0.085106	0.0000	0.18720	208.63	0.91901
0.063830	0.0000	0.18390	204.64	0.90281
0.042553	0.0000	0.18000	200.98	0.88366

Downstream Velocity Profile

y/w	z	M	U	U/Umax
0.91489	0.0000	0.17510	196.65	0.87418
0.89362	0.0000	0.18410	206.76	0.91912
0.87234	0.0000	0.18970	213.04	0.94707
0.85106	0.0000	0.19490	218.88	0.97303
0.82979	0.0000	0.19590	220.01	0.97803
0.80851	0.0000	0.19810	222.48	0.98901
0.78723	0.0000	0.19920	223.71	0.99450
0.76596	0.0000	0.19980	224.39	0.99750
0.74468	0.0000	0.19980	224.39	0.99750
0.72340	0.0000	0.19920	223.71	0.99450
0.70213	0.0000	0.19720	221.47	0.98452
0.68085	0.0000	0.19950	224.05	0.99600
0.65957	0.0000	0.20030	224.95	0.99999
0.63830	0.0000	0.20020	224.84	0.99949
0.61702	0.0000	0.19940	223.94	0.99550
0.59574	0.0000	0.19970	224.27	0.99700
0.57447	0.0000	0.19860	223.04	0.99151
0.55319	0.0000	0.19760	221.92	0.98651
0.53191	0.0000	0.19980	224.39	0.99750
0.51064	0.0000	0.19860	223.04	0.99151
0.48936	0.0000	0.19720	221.47	0.98452
0.46809	0.0000	0.19690	221.13	0.98302
0.44681	0.0000	0.19740	221.69	0.98552
0.42553	0.0000	0.19730	221.58	0.98502
0.40426	0.0000	0.19600	220.12	0.97853
0.38298	0.0000	0.19580	219.89	0.97753
0.36170	0.0000	0.19580	219.89	0.97753
0.34043	0.0000	0.19630	220.46	0.98002
0.31915	0.0000	0.19800	222.37	0.98851
0.29787	0.0000	0.19740	221.69	0.98552

0.27660	0.0000	0.19760	221.92	0.98651
0.25532	0.0000	0.19890	223.38	0.99300
0.23404	0.0000	0.19510	219.11	0.97403
0.21277	0.0000	0.19490	218.88	0.97303
0.19149	0.0000	0.19500	219.00	0.97353
0.17021	0.0000	0.19340	217.20	0.96555
0.14894	0.0000	0.19100	214.50	0.95356
0.12766	0.0000	0.18760	210.69	0.93659
0.10638	0.0000	0.18000	202.15	0.89865
0.085106	0.0000	0.17340	194.74	0.86570
0.063830	0.0000	0.16590	186.32	0.82825

Liner
M = 0.3

Upstream Velocity Profile

y/w	z	M	U	U/Umax
-0.68085	0.0000	0.30270	334.84	0.99246
-0.65957	0.0000	0.30300	333.77	0.99344
-0.63830	0.0000	0.30490	335.97	0.99967
-0.61702	0.0000	0.30470	336.46	0.99902
-0.59574	0.0000	0.30450	335.76	0.99836
-0.57447	0.0000	0.30480	336.06	0.99934
-0.55319	0.0000	0.30520	336.34	1.0007
-0.53191	0.0000	0.30500	336.74	1.00000
-0.51064	0.0000	0.30500	335.85	1.00000
-0.48936	0.0000	0.30500	336.63	1.00000
-0.46809	0.0000	0.30470	337.17	0.99902
-0.44681	0.0000	0.30440	334.85	0.99803
-0.42553	0.0000	0.30490	336.11	0.99967
-0.40426	0.0000	0.30270	334.36	0.99246
-0.38298	0.0000	0.30260	334.41	0.99213
-0.36170	0.0000	0.30260	333.73	0.99213
-0.34043	0.0000	0.30170	334.74	0.98918
-0.31915	0.0000	0.30000	331.08	0.98361
-0.29787	0.0000	0.29790	329.16	0.97672
-0.27660	0.0000	0.29770	329.37	0.97606
-0.25532	0.0000	0.29620	327.18	0.97115
-0.23404	0.0000	0.29620	326.95	0.97115
-0.21277	0.0000	0.29400	325.34	0.96393
-0.19149	0.0000	0.29390	323.62	0.96361
-0.17021	0.0000	0.29230	323.10	0.95836
-0.14894	0.0000	0.29030	320.27	0.95180
-0.12766	0.0000	0.28810	319.26	0.94459
-0.10638	0.0000	0.28610	316.03	0.93803
-0.085106	0.0000	0.28100	310.59	0.92131
-0.063830	0.0000	0.27630	305.16	0.90590
-0.042553	0.0000	0.26940	298.82	0.88328

Downstream Velocity Profile

y/w	z	M	U	U/Umax
-0.063830	0.0000	0.25360	283.99	0.82525
-0.085106	0.0000	0.26800	300.12	0.87211
-0.10638	0.0000	0.28100	314.68	0.91441
-0.12766	0.0000	0.29320	328.34	0.95411
-0.14894	0.0000	0.30100	337.07	0.97949
-0.17021	0.0000	0.30160	337.75	0.98145
-0.19149	0.0000	0.30430	340.77	0.99023
-0.21277	0.0000	0.30380	340.21	0.98861
-0.23404	0.0000	0.30290	339.20	0.98568
-0.25532	0.0000	0.30460	341.10	0.99121
-0.27660	0.0000	0.30500	341.55	0.99251
-0.29787	0.0000	0.30360	339.98	0.98795
-0.31915	0.0000	0.30360	339.98	0.98795
-0.34043	0.0000	0.30490	341.44	0.99219
-0.36170	0.0000	0.30490	341.44	0.99219
-0.38298	0.0000	0.30470	341.22	0.99153
-0.40426	0.0000	0.30490	341.44	0.99219
-0.42553	0.0000	0.30430	340.77	0.99023
-0.44681	0.0000	0.30430	340.77	0.99023
-0.46809	0.0000	0.30460	341.10	0.99121
-0.48936	0.0000	0.30460	341.10	0.99121
-0.51064	0.0000	0.30500	341.55	0.99251
-0.53191	0.0000	0.30450	340.99	0.99088
-0.55319	0.0000	0.30650	343.23	0.99739
-0.57447	0.0000	0.30580	342.45	0.99511
-0.59574	0.0000	0.30560	342.22	0.99446
-0.61702	0.0000	0.30540	342.00	0.99381
-0.63830	0.0000	0.30420	340.66	0.98991
-0.65957	0.0000	0.30590	342.56	0.99544
-0.68085	0.0000	0.30730	344.13	1.00000

-0.70213	0.0000	0.30680	343.57	0.99837	
-0.72340	0.0000	0.30600	342.67	0.99576	
-0.74468	0.0000	0.30560	342.22	0.99446	
-0.76596	0.0000	0.30550	342.11	0.99414	
-0.78723	0.0000	0.30540	342.00	0.99381	
-0.80851	0.0000	0.30300	339.31	0.98600	
-0.82979	0.0000	0.30220	338.42	0.98340	
-0.85106	0.0000	0.29790	333.60	0.96941	
-0.87234	0.0000	0.29070	325.54	0.94598	

REPORT DOCUMENTATION PAGE			Form Approved OMB No. 0704-0188
Public reporting burden for this collection of information is estimated to average 1 hour per response, including the time for reviewing instructions, searching existing data sources, gathering and maintaining the data needed, and completing and reviewing the collection of information. Send comments regarding this burden estimate or any other aspect of this collection of information, including suggestions for reducing this burden, to Washington Headquarters Services, Directorate for Information Operations and Reports, 1215 Jefferson Davis Highway, Suite 1204, Arlington, VA 22202-4302, and to the Office of Management and Budget, Paperwork Reduction Project (0704-0188), Washington, DC 20503.			
1. AGENCY USE ONLY (Leave blank)	2. REPORT DATE December 2000	3. REPORT TYPE AND DATES COVERED Contractor Report	
4. TITLE AND SUBTITLE Flow Duct Data for Validation of Acoustic Liner Codes for Impedance Education		5. FUNDING NUMBERS G NAG1-1734 WU 522-63-11-02	
6. AUTHOR(S) K. K. Ahuja, Scott Munro, and R. J. Gaeta, Jr.			
7. PERFORMING ORGANIZATION NAME(S) AND ADDRESS(ES) Georgia Inst. of Technology, GTRI/ATASL Aerospace & Acoustics Technologies Branch Atlanta, GA 30332-0844		8. PERFORMING ORGANIZATION REPORT NUMBER A5004/2000-2	
9. SPONSORING/MONITORING AGENCY NAME(S) AND ADDRESS(ES) National Aeronautics and Space Administration Langley Research Center Hampton, VA 23681-2199		10. SPONSORING/MONITORING AGENCY REPORT NUMBER NASA/CR-2000-210634	
11. SUPPLEMENTARY NOTES Langley Technical Monitor: Michael G. Jones			
12a. DISTRIBUTION/AVAILABILITY STATEMENT Unclassified-Unlimited Subject Category 71 Distribution: Nonstandard Availability: NASA CASI (301) 621-0390		12b. DISTRIBUTION CODE	
13. ABSTRACT (Maximum 200 words) The objective of this study was to acquire acoustic and flow data with hard and lined duct wall sections for validation of a liner prediction code being developed at NASA LaRC. Both the mean and acoustic flowfields were determined in a cross-plane of the rectangular duct. The test liner was of the locally-reacting type and was made from a ceramic material. The material, consisting of a tubular structure, was provided by NASA LaRC. Flow measurements included pressure, temperature, and velocity profiles upstream of the liner section. The in-flow sound pressure levels and phases were obtained with a microphone probe equipped with a nose cone in two cross planes upstream of the liner and in two cross plane downstream of the liner. In addition to the acoustic measurements at the cross planes, axial centerline acoustic data was acquired using an axially traversing microphone probe that was traversed from a location upstream of the liner to some distance downstream of the liner. Much of the data was acquired for frequencies of 500, 1000, 1500, 2000 and 2500 Hz and for duct mean flow Mach numbers of 0.0, 0.1, 0.2, and 0.3.			
14. SUBJECT TERMS Acoustic Liners; Sound Absorption; Liner Impedance; Impedance Education; Liner Code Validation; Flow Duct; 2DOF Locally Reacting Liner		15. NUMBER OF PAGES 128	16. PRICE CODE A07
17. SECURITY CLASSIFICATION OF REPORT Unclassified	18. SECURITY CLASSIFICATION OF THIS PAGE Unclassified	19. SECURITY CLASSIFICATION OF ABSTRACT Unclassified	20. LIMITATION OF ABSTRACT UL