



# **GLOBE**

## **GLOBAL CONFERENCE ON BUSINESS AND ECONOMICS**

### **ADVANCES IN GLOBAL BUSINESS AND ECONOMICS**

**Editor  
Dr. Cihan Cobanoglu**

**2018**

Editor

Dr. Cihan Cobanoglu

**ADVANCES IN GLOBAL  
BUSINESS AND ECONOMICS**

**Proceedings of the GLOBE Conference  
in Sarasota, USA, June 4-8, 2018**

Editor

Dr. Cihan Cobanoglu

M3 Center

University of South Florida Sarasota-Manatee

USA

ISBN 978-1-7321275-1-7

© ANAHEI Publishing 2018 This work is subject to copyright. All rights are reserved by the Publisher, whether the whole or part of the material is concerned, specifically the rights of translation, reprinting, reuse of illustrations, recitation, broadcasting, reproduction on microfilms or in any other physical way, and transmission or information storage and retrieval, electronic adaptation, computer software, or by similar or dissimilar methodology now known or hereafter developed. The use of general descriptive names, registered names, trademarks, service marks, etc. in this publication does not imply, even in the absence of a specific statement, that such names are exempt from the relevant protective laws and regulations and therefore free for general use. The publisher, the authors and the editors are safe to assume that the advice and information in this book are believed to be true and accurate at the date of publication. Neither the publisher nor the authors or the editors give a warranty, express or implied, with respect to the material contained herein or for any errors or omissions that may have been made. The publisher remains neutral with regard to jurisdictional claims in published maps and institutional affiliations.

This imprint is published by ANAHEI Publishing, LLC The registered company address is: 3934 South East Avenue, Sarasota, FL 34239 USA

# Chair & Scientific Committee

## Conference Honorary Chair:

Dr. Moez Limayem, Dean & Professor, University of South Florida

## Program Chair & Host of the Conference:

Dr. Cihan Cobanoglu, McKibbin Endowed Chair Professor, University of South Sarasota-Manatee & President of ANAHEI

## Scientific Organizing Committee Chairs:

Dr. Patrick J. Moreo, Dean & Professor, University of South Florida Sarasota-Manatee, USA

Dr. Kelly Way, Assistant Director & Associate Professor, University of Arkansas, USA

Dr. Ayse Bas Collins, Associate Professor, Bilkent University, Turkey

Dr. S. Mostafa Rasoolimanesh, Senior Lecturer, Taylor's University

## International Scientific Committee for 8 Conference:

Dr. Abudy, Meni, Assistant Professor, Bar-Ilan University, Israel

Dr. Ahmed, Faisal, Associate Professor, FORE School of Management, India

Dr. Al-Madi, Faisal, Associate Professor, Hashemite University, Jordan

Dr. Altin, Mehmet, Assistant Professor, University of Central Florida, USA

Dr. Amaro, Suzanne, Associate Professor, Polytechnic Institute of Viseu, Portugal

Dr. Ampountolas, Apostolos, Assistant Professor, Boston University, USA

Dr. Andraz, Georgette, Assistant Professor, Algarve University, Portugal

Dr. Angiola, Nunzio, Professor, University of Foggia, Italy

Dr. Arcidiacono, Davide, Assistant Professor, Catholic University of the Sacred Heart, Italy

Dr. Ardalan, Kavous, Professor, Marist College, USA

Dr. Arteaga, Julio, Professor, Autonomous University of Nuevo Leon, Mexico

Dr. Assaf, Ata, Professor, University of Balamand, Lebanon

Dr. Avola, Danilo, Professor, Sapienza University, Italy

Dr. Bagis, Bilal, Associate Professor, Bingol University, Turkey

Dr. Banerjee, Sudatta, Department Head, Birla Institute of Technology and Science - Pilani, India

Dr. Belik, Ivan, Assistant Professor, Norwegian School of Economics, Norway

Dr. Berezina, Katerina, Assistant Professor, University of South Florida Sarasota-Manatee, USA

Dr. Bertoni, Michele, Associate Professor, University of Trieste, Italy

Dr. Billiot, Theresa, Associate Professor, Cameron University, USA

Dr. Blenman, Lloyd, Professor, University of North Carolina-Charlotte, USA

Dr. Boukas, Nikolaos, Associate Professor, European University Cyprus, Cyprus

Dr. Breslawski, Steven, Associate Professor, State University of New York, USA

Dr. Brodie, Jacqueline, Senior Lecturer, Edinburgh Napier University, UK

Dr. Brown, Abraham, Assistant Professor, Nottingham Trent University, UK

Dr. Guerreiro, C. Raul Filipe, Professor, Algarve University, Portugal

Dr. Caleiro, Antonio, Assistant Professor, University of Evora, Portugal

Dr. Calhoun, Jennifer, Assistant Professor, Coastal Carolina University, USA

Dr. Calvo, Nuria, Associate Professor, University of A Coruna, Spain

Dr. Capriello, Antonella, Associate Professor, University of Piemonte Orientale, Italy

Dr. Carrasco, Paulo, Professor, Algarve University, Portugal

Dr. Carvalho, Paulo, Assistant Professor, University Institute of Lisbon, Portugal

Dr. Castro, Rita, Researcher, University of Aveiro, Portugal

Dr. Cetinkaya, Ali Sukru, Associate Professor, Selcuk University, Turkey

Dr. Chen, Chih-Hsiang, Associate Professor, Peking University, China

Dr. Chen, Qihui, Associate Professor, China Agricultural University, China

Dr. Chishty-Mujahid, Nadya, Assistant Professor, Institute of Business Administration, Pakistan

Dr. Choi, Juwon, Assistant Professor, The University of Southern Mississippi, USA

Dr. Cifarelli, Giulio, Professor, University of Florence, Italy

Dr. Cincinelli, Peter, Assistant Professor, University of Bergamo, Italy

Dr. Cocianu, Catalina, Professor, The Bucharest University of Economic Studies, Romania

Dr. Collins, Ayse, Associate Professor, Bilkent University, Turkey

Dr. Corbin, Deborah, Assistant Professor, Eastern New Mexico University, USA

Dr. Corvino, Antonio, Associate Professor, University of Foggia, Italy

Dr. Crampton, Suzanne, Professor, Grand Valley State University, USA

Dr. Crespo, Nuno, Assistant Professor, University Institute of Lisbon, Portugal

Dr. D'Amato, Antonio, Assistant Professor, University of Salerno, Italy

Dr. D'Amato, Vittorio, Professor, University Carlo Cattaneo, Italy

Dr. Daraio, Cinzia, Associate Professor, Sapienza University of Rome, Italy

Dr. Darmer, Per, Associate Professor, Copenhagen Business School, Denmark

Dr. Darwish, Saad, Professor, Applied Science University, Bahrain

Dr. Das, Roshni, Research Scholar, Indian Institute of Management Indore, India

Dr. De Martino, Marcella, Researcher, National Research Council, Italy

Dr. De Vita, Luisa, Assistant Professor, Sapienza University of Rome, Italy

Dr. Dedeoglu, Bekir Bora, Research Assistant, Nevsehir Haci Bektas Veli University, Turkey

Dr. Dishon-Berkovits, Miriam, Assistant Professor, Ono Academic College, Israel

Dr. Du, Julian, Associate Professor, Chinese University of Hong Kong, Hong Kong (S.A.R.)

Dr. Egilsson, Vilhjalmur, Chancellor, Bifrost University, Iceland

Dr. Eisel, Joyce, Assistant Professor, Harris Stowe State University, USA

Dr. Fassari, Letteria Grazia, Assistant Professor, Sapienza University of Rome, Italy

Dr. Federici, Daniela, Associate Professor, University of Cassino and Southern Lazio, Italy

Dr. Feng, J.Z., Professor, South China Normal University, China

Dr. Ferrari, Sonia, Associate Professor, University of Calabria, Italy

Dr. Ferreira-Lopes, Alexandra, Assistant Professor, University Institute of Lisbon, Portugal

Dr. Fonseca, Marcia, Associate Professor, Federal University of Paraiba, Brazil

Dr. Frascaroli, Bruno, Associate Professor, Federal University of Paraiba, Brazil

Dr. Gabbianelli, Linda, Research Fellow, University of Urbino, Italy

Dr. Garcia - Alvarez, Maria Teresa, Associate Professor, University of A Coruna, Spain

Dr. Garcia Muniz, Ana Salome, Associate Professor, University of Oviedo, Spain

Dr. Genc, Ruhet, Professor, Turkish-German University, Turkey

Dr. Genova, Angela, Professor, University of Urbino, Italy

Dr. Giacomini, Emanuela, Assistant Professor, University of Macerata, Italy

Dr. Giusti, Carlo Alberto, Associate Professor, eCampus University, Italy

Dr. Gokhale, Jayendra, Assistant Professor, Embry-Riddle Aeronautical University, USA

Dr. Goldschmidt, Nadav, Assistant Professor, Center for Academic Studies, Israel

Dr. Gospodinova, Anna, Other, University of Economics Varna, Bulgaria

Dr. Gregus, Michal, Professor/Head of Department, Comenius University in Bratislava, Slovakia

Dr. Guillo, Maria D., Associate Professor, University of Alicante, Spain

Dr. Guo, Jang-Ting, Professor, University of California, USA

Dr. Hashemi, Shohreh, Associate Professor, University of Houston-Downtown, USA

Dr. Holck, Lotte, Researcher, Copenhagen Business School, Denmark

Dr. Hugl, Ulrike, Associate Professor, University of Innsbruck, Austria

Dr. Ivantchev, Boyan, Associate Professor, University for National and World Economy, Bulgaria

Dr. Kahil, Magd, Associate Professor, Modern Sciences and Arts University, Egypt

Dr. Kamboj, Shampy, Assistant Professor, Amity University Noida, India

Dr. Kaucic, Massimiliano, Assistant Professor, University of Trieste, Italy

Dr. Kim, Hee Youn, Senior Researcher, University of Florida, USA

Dr. Kim, Sun-Hwa, Assistant Professor, Montana State University, USA

Dr. Krasna, Francesca, Associate Professor, University of Trieste, Italy

Dr. Khataybeh, Mohammad, Assistant Professor, The Hashemite University, Jordan

Dr. Kryvinska, Natalia, Associate Professor, University of Vienna, Austria

Dr. Ku, Fred, Assistant Dean, Chinese University of Hong Kong, Hong Kong (S.A.R.)

Dr. Kuczewska, Joanna, Assistant Professor, University of Gdansk, Poland

Dr. Lanzini, Pietro, Assistant Professor, Ca' Foscari University of Venice, Italy

Dr. Latino, Agostina, Assistant Professor, University of Camerino, Italy

Dr. Lee, HyeRyeon, Assistant Professor, Wilkes University, USA

Dr. Leshoro, Temitope, Associate Professor, University of South Africa, South Africa

Dr. Ieva, Marco, Research Fellow, University of Parma, Italy

Dr. Lita, Ratni Prima, Lecturer, Andalas University, Indonesia

Dr. Liu, Tsong-Zen, Professor, National Kaohsiung University of Hospitality and Tourism, Taiwan

Dr. Liu, Xuefeng, Assistant Professor, Loyola University Maryland, USA  
 Dr. Lok, C K, Lecturer, The University of Hong Kong, Hong Kong (S.A.R.)  
 Dr. Lopes, Ana, Assistant Professor, Leiria Polytechnic Institute, Portugal  
 Dr. Lorca, Pedro, Associate Professor, University of Oviedo, Spain  
 Dr. Maimone, Fabrizio, Lecturer, Assunta University of Rome, Italy  
 Dr. Martelli, Duccio, Assistant Professor, University of Perugia, Italy  
 Dr. Martinelli, Elisa, Associate Professor, University of Modena and Reggio Emilia, Italy  
 Dr. Martins, Ana, Professor, Algarve University, Portugal  
 Dr. Matos, Nelson, Assistant Professor, Algarve University, Portugal  
 Dr. Mendes, Luis, Assistant Professor, University of Beira Interior, Portugal  
 Dr. Merella, Vincenzo, Assistant Professor, University of Cagliari, Italy  
 Dr. Mester, Liana-Eugenia, Associate Professor, University of Oradea, Romania  
 Dr. Miguel, Antonio, Assistant Professor, University Institute of Lisbon, Portugal  
 Dr. Migueles, Carmen, Professor, Fundacao Getulio Vargas University, Brazil  
 Dr. Min, Jihye, Assistant Professor, University of North Texas, USA  
 Dr. Moissello, Anna maria, Professor, University of Pavia, Italy  
 Dr. Morandi, Francesco, Professor, University of Sassari, Italy  
 Dr. Moshiri, Saeed, Associate Professor, University of Saskatchewan, Canada  
 Dr. Mourelle, Estefania, Assistant Professor, University of Coruna, Spain  
 Dr. Nmadu, Job, Professor, Federal University of Technology, Nigeria  
 Dr. Parello, Carmelo Pierpaolo, Associate Professor, Sapienza University of Rome, Italy  
 Dr. Park, Kunsoo, Assistant Professor, South Dakota State University, USA  
 Dr. Paskelian, Ohannes, Associate Professor, University of Houston Downtown, USA  
 Dr. Pathak, Durgesh, Assistant Professor, Birla Institute of Technology and Science, India  
 Dr. Peng, Lihong, Professor, Renmin University, China  
 Dr. Pestana, Maria Helena, Assistant Professor, Lisbon University, Portugal  
 Dr. Pezzuto, Ivo, Professor, International School of Management of Paris, France  
 Dr. Phalin, Amanda, Lecturer, University of Florida, USA  
 Dr. Pizzurno, Emanuele, Assistant Professor, University Carlo Cattaneo, Italy  
 Dr. Previtali, Daniele, Lecturer, Liberal International University of Social Studies Guido Carli, Italy  
 Dr. Proterogeros, Nicolaos, Associate Professor, University of Macedonia, Greece  
 Dr. Queiroz, Regina, Associate Professor, Nova University of Lisbon, Portugal  
 Dr. Ramos, Celia, Assistant Professor, University of the Algarve, Portugal  
 Dr. Rebelo, Sandra, Assistant Professor, University of the Algarve, Portugal  
 Dr. Rehman, Faiz Ur, Assistant Professor, Quaid-i-Azam University, Pakistan  
 Dr. Reynolds, Joel, Assistant Professor, Niagara University, USA  
 Dr. Rezvanian, Rasoul, Associate Dean, Ithaca College, USA  
 Dr. Ricci, Andrea, Assistant Professor, University of Urbino, Italy  
 Dr. Rija, Maurizio, Associate Professor, University of Calabria, Italy  
 Dr. Romero, Jorge, Associate Professor, Towson University, USA  
 Dr. Rossi, Paola, Assistant Professor, University of Trento, Italy  
 Dr. Rotaris, Lucia, Associate Professor, University of Trieste, Italy  
 Dr. Said, Hassan, Professor, Austin Peay State University, USA  
 Dr. Salem, Islam, Assistant Professor, Alexandria University, Egypt  
 Dr. Sanchez, Evangelina, Professor, Leyte Normal University, Philippines  
 Dr. Sanfelici, Simona, Associate Professor, University of Parma, Italy  
 Dr. Sangi, Nazir Ahmed, Professor, Allama Iqbal Open University, Pakistan  
 Dr. Santos, Jose, Assistant Professor, University of Algarve, Portugal  
 Dr. Schiffer, Eileen, Assistant Professor, Marylhurst University, USA  
 Dr. Schroeder, Ashley, Managing Director, Tourism Crisis Management Initiative, University of Florida, USA  
 Dr. Serdeira Azevedo, Paula, Associate Professor, University of Algarve, Portugal  
 Dr. Sheina, Marina, Associate Professor, National Research University Higher School of Economics, Russia  
 Dr. Simeoni, Francesca, Assistant Professor, University of Verona, Italy  
 Dr. Simoes, Nadia, Assistant Professor, University Institute of Lisbon, Portugal  
 Dr. Sousa, Filipe, Assistant Professor, University of Madeira, Portugal  
 Dr. Stefanelli, Valeria, Professor, University of Salento, Italy  
 Dr. Stefaniak, Joanna, Assistant Professor, University of Gdansk, Poland  
 Dr. Sumedrea, Silvia, Associate Professor, Transilvania University of Brasov, Romania  
 Dr. Sweis, Khalid, Associate Professor, Palestine Technical University, Palestine  
 Dr. Tabari, Salomeh, Assistant Professor, Sheffield Hallam University, UK  
 Dr. Taliento, Marco, Professor, University of Foggia, Italy  
 Dr. Tekin, M.J. Ni. Ilknur, Professor, Bocconi University, Italy  
 Dr. Testa, Pierpaolo, Assistant Professor, University of Naples Federico II, Italy  
 Dr. Tofan, Cezarina Adina, Associate Professor, University of Pitesti, Romania  
 Dr. Torre, Teresina, Associate Professor, University of Genoa, Italy  
 Dr. Tucker, Mary, Professor, Ohio University, USA  
 Dr. Turon, Alberto, Associate Professor, University of Zaragoza, Spain  
 Dr. Tutino, Marco, Associate Professor, Roma Tre University, Italy  
 Dr. Valentinuz, Giorgio, Assistant Professor, University of Trieste, Italy  
 Dr. Valles-Gimenez, Jaime, Professor, University of Zaragoza, Spain  
 Dr. van Niekerk, Mathilda, Assistant Professor, University of Central Florida, USA  
 Dr. Varela Candamio, Laura, Assistant Professor, University of A Coruna, Spain  
 Dr. Ventura, Luigi, Professor, Sapienza University of Rome, Italy  
 Dr. Vetrova, Elena, Professor, Saint-Petersburg State University of Economics, Russia  
 Dr. Vieira, Isabel, Assistant Professor, University of Evora, Portugal  
 Dr. Vincent, Jennifer, Professor, Champlain College, USA  
 Dr. Vohra, Anupama, Associate Professor, University of Delhi, India  
 Dr. Vouzas, Fotios, Associate Professor, University of Macedonia, Greece  
 Dr. Waldo, R. Douglas, Assistant Professor, Liberty University, USA  
 Dr. Wang, Shuye, Professor, Renmin University of China, China  
 Dr. Wang, Yao-Chin, Assistant Professor, University of Arkansas, USA  
 Dr. Wen, Xiaoqin, Assistant Professor, Shanghai University, China  
 Dr. Yagci, Kamil, Professor, Pamukkale University, Turkey  
 Dr. Yang, Bo, Professor, Zhongnan University of Economics and Law, China  
 Dr. Yekini, Kemi, Associate Professor, Nottingham University, UK  
 Dr. Yildirim, Cansu, Assistant Professor, Dokuz Eylul University, Turkey  
 Dr. Yilmaz, Burcu Selin, Professor, Dokuz Eylul University, Turkey  
 Dr. Yong, Chen Chen, Associate Professor, University of Malaya, Malaysia  
 Dr. Yu, T. Robert, Assistant Professor, University of Wisconsin-Whitewater, USA  
 Dr. Zakharenko, Roman, Associate Professor, National Research University Higher School of Economics, Russia  
 Dr. Zambujal-Oliveira, J., Professor, University of Madeira, Portugal  
 Dr. Zeng, Runxi, Professor, Chongqing University, China  
 Dr. Zhang, Gui, Professor, Hebei University of Technology, China  
 Dr. Zhou, Zehai, Associate Professor, University of Houston-Downtown, USA

### **International Director of Conferences and Events:**

Cavusoglu, Muhittin, M.S., College of Education, University of South Florida, USA

### **Media Manager:**

Corbaci, Onur Emre, Dokuz Eylul University & University of South Florida Sarasota-Manatee

### **Scientific Relations Coordinators:**

Heckle, Claire, College of Hospitality and Tourism Leadership, University of South Florida Sarasota-Manatee

Nanu, Luana, College of Hospitality and Tourism Leadership, University of South Florida Sarasota-Manatee

# Table of Contents

<b>Part 1: Consumer Behavior .....</b>	<b>1</b>
<b><i>The Types and Motivation of Social Network Users: A Qualitative Study of Young Adults .....</i></b>	<b>2</b>
Jamil Hebali .....	2
<b><i>New Digital Currency and Technological Transformation .....</i></b>	<b>12</b>
Massimiliano Minaudo .....	12
<b>Part 2: Economics .....</b>	<b>20</b>
<b><i>Valuation of Public Goods in Agricultural Landscape: The Case of Slovakia .....</i></b>	<b>21</b>
Veronika Nambuge, Artan Qineti, Miroslava Rajcaniova, and Dimuth Nambuge .....	21
<b>Part 3: Education &amp; Training .....</b>	<b>30</b>
<b><i>Developing Global Leaders: A Study of MBA Programs in the Caribbean and Central America .....</i></b>	<b>31</b>
Paul Pounder and Rachael Ross .....	31
<b>Part 4: Finance &amp; Banking .....</b>	<b>43</b>
<b><i>One-Sided Linking of Mortgage Loans to the Price of Foreign Currencies .....</i></b>	<b>44</b>
Nahum Biger .....	44
<b><i>Market Related and Market Independent Components of Company Stock Return in Bangladesh: Which is Stronger? .....</i></b>	<b>55</b>
Sumaiya Zaman .....	55
<b>Part 5: Hospitality &amp; Tourism .....</b>	<b>65</b>
<b><i>Demystifying Gender Bias Intensity in Service Based Organizations .....</i></b>	<b>66</b>
Noel Criscione-Naylor and Jane Bokunewicz .....	66
<b><i>Self-Efficacy and Job Outcomes Among Tour Guides .....</i></b>	<b>77</b>
Jennifer C. H. Min .....	77
<b><i>Determination of the Contributions of Local Authorities to Develop Gastronomy Tourism: Adana Sample .....</i></b>	<b>88</b>
Hulya Tastan, Kemal Enes, and Elanur Sahin .....	88

<b><i>The Effects of Personality Traits of Employees on Their Socialization Levels: A Research in Hospitality Establishments</i></b> .....	<b>97</b>
Eda Ozgul Katlav <sup>1</sup> , Nilufer Sahin Percin <sup>1</sup> , and Muhittin Cavusoglu <sup>2</sup> .....	97
<b><i>The Evaluation of Influence Tactics Perception of Hospitality Establishment Employees in Terms of Demographic Variables</i></b> .....	<b>106</b>
Gaye Deniz <sup>1</sup> , Nilufer Sahin Percin <sup>1</sup> , and Muhittin Cavusoglu <sup>2</sup> .....	106
<b><i>Part 6: Human Resource Management</i></b> .....	<b>112</b>
<b><i>Demystifying the Antecedents of Presenteeism in Hospitality Industry</i></b> .....	<b>113</b>
Kayode K. Eluwole, Taiwo T. Lasisi and Turgay Avci .....	113
<b><i>Part 7: Innovation &amp; Entrepreneurship</i></b> .....	<b>119</b>
<b><i>Strategic Flexibility as a Key to Innovativeness: Theoretical Framework</i></b> .....	<b>120</b>
Dmytro Shestakov .....	120
<b><i>Part 8: International Trade &amp; Management</i></b> .....	<b>132</b>
<b><i>Firm’s Competitiveness in Global Economy and Cost (Structure) Management</i></b> .....	<b>133</b>
Mehmet Hanifi Ayboga <sup>1</sup> , Asaf Murat Altug <sup>2</sup> , and Ersem Karadag <sup>3</sup> .....	133
<b><i>Part 9: Strategy &amp; Global Trends</i></b> .....	<b>142</b>
<b><i>Organizational Complexity and Uncertainty: A Conceptual Evaluation of Proactive Environmental Strategy on Organizational Competitiveness</i></b> .....	<b>143</b>
Taiwo T. Lasisi, Kayode K. Eluwole, and Ali Ozturen .....	143
<b><i>Part 10: Technology, E-Business &amp; Social Media</i></b> .....	<b>153</b>
<b><i>Customer Engagement With Social Commerce: A Motivation Analysis</i></b> .....	<b>154</b>
Tingting Zhang and Po-Ju Chen.....	154
<b><i>Part 11: Chapter of Abstracts</i></b> .....	<b>161</b>
<b><i>Accounting</i></b> .....	<b>162</b>
<b><i>Necessary and Sufficient Conditions for Liquidity Management</i></b> .....	<b>163</b>
José Antonio de França <sup>1</sup> and Wilfredo Sosa Sandoval <sup>2</sup> .....	163

<b><i>Asset Misappropriation in Hospitality Industry as a Result of Weak Internal Control: A Content Analysis of 53 Cases</i></b> .....	<b>164</b>
Ersem Karadag <sup>1</sup> , Sezayi Dumanoglu <sup>2</sup> , and Gulsah Sahin <sup>3</sup> .....	164
<b><i>Consumer Behavior</i></b> .....	<b>165</b>
<b><i>A Cross-Cultural Study on Tourism: Strategies and Implications of Findings</i></b> .....	<b>166</b>
Sushant Kumar, Vishalwat Giridhar, Pradip H Sadarangani, and Bidyut J Gogoi .....	166
<b><i>What Does the Customer of Café-Corner Expect From a Service Delivery?</i></b> .....	<b>167</b>
Salomeh Tabari <sup>1</sup> , Joanna Kuczevska <sup>2</sup> , Anne Conneally <sup>1</sup> , and Joanna Stefaniak <sup>2</sup> .....	167
<b><i>Privacy Protection Proclivity and Trust: No Longer Concerns of Today’s International M-Commerce Users?</i></b> .....	<b>170</b>
Brent J. Cunningham, James L. Thomas, and Jianping Coco Huang .....	170
<b><i>Consumer Evaluation of Celebrity Brand Extensions: An Affect Transference Perspective</i></b> .	<b>177</b>
Tracy H. Kizer.....	177
<b><i>The Comparison of Asian and Non-Asian Business Travelers' Hotel Service Preferences</i></b> ...	<b>180</b>
Faranak Memarzadeh <sup>1</sup> and Sulekha Anand <sup>2</sup> .....	180
<b><i>Economics</i></b> .....	<b>183</b>
<b><i>Do Superfund Sites Cause Superwages?</i></b> .....	<b>184</b>
Jeff Felardo .....	184
<b><i>The Impact of Bankruptcy Law on Entrepreneurship (Self-Employment)</i></b> .....	<b>187</b>
Sylvia Morawska <sup>1</sup> , Joanna Kuczevska <sup>2</sup> , and Błażej Prusak <sup>3</sup> .....	187
<b><i>Education &amp; Training</i></b> .....	<b>190</b>
<b><i>Hospitality Education Program Student Operated Restaurants: A Practical Education Component</i></b> .....	<b>191</b>
Angad Singh Dang and Patrick Moreo .....	191
<b><i>Keeping Hospitality, Travel, and Tourism Students on the Pathway: A Guided Learning Journey to Success With ePortfolio</i></b> .....	<b>193</b>
Leslie G. Scamacca and James Giordano.....	193
<b><i>Who Wants Business and Economics Diploma via Open Education: Example of Anadolu University, Turkey</i></b> .....	<b>196</b>
Hasan Durucasu <sup>1</sup> and Fikret Er <sup>2</sup> .....	196



<b><i>Innovation of Online Training Program With the Implementation of High-Impact Integrative Learning Structure for the Hospitality Faculty.....</i></b>	<b>198</b>
Murat Kizildag <sup>1</sup> , Nan Hua <sup>1</sup> , Ahmet Bulent Ozturk <sup>1</sup> , Baiyun Chen <sup>2</sup> , and Beth Nettles <sup>2</sup> .....	198
<b><i>Finance &amp; Banking .....</i></b>	<b>201</b>
<b><i>To What Extent Does Franchise Decision Affects Restaurant Firm's Financial Performance? .....</i></b>	<b>202</b>
Ayşegül Acar <sup>1</sup> and Mehmet Erkan <sup>2</sup> .....	202
<b><i>Factors Affecting Usage Intention of Mobile Banking: Empirical Evidence From Turkey ..</i></b>	<b>206</b>
Aytac Erdem, Ufuk Pala, Ugur Sevim, and Mustafa Ozkan.....	206
<b><i>Trends and Performance of Travel and Leisure Indices .....</i></b>	<b>209</b>
Tuba Sevil <sup>1</sup> , Usman M. Umer <sup>2</sup> , and Güven Sevil <sup>2</sup> .....	209
<b><i>Revisiting the Spot-Future Relationships: Case of Emerging Stock Markets .....</i></b>	<b>213</b>
Güven Sevil <sup>1</sup> , Melik Kamlı <sup>2</sup> , Serap Kamlı <sup>2</sup> , Tuba Sevil <sup>3</sup> , and Fatih Temizel <sup>4</sup> .....	213
<b><i>The Enforcement of the Rule of Law in the Financial Sector: The Strategic Synergies Among Judicial Authority and Financial Supervisory Authorities .....</i></b>	<b>217</b>
Carlo Alberto Giusti .....	217
<b><i>Hospitality &amp; Tourism.....</i></b>	<b>220</b>
<b><i>Analyzing Online Reviews on Hotels by Humans Versus Artificial Intelligence .....</i></b>	<b>221</b>
Fevzi Okumus <sup>1</sup> , Ahmet Ozturk <sup>1</sup> , Anil Bilgihan <sup>2</sup> , and Chenge Jia <sup>1</sup> .....	221
<b><i>How Much Does the Consumer-Based Brand Equity Affect the Financial Performance of the Company? .....</i></b>	<b>222</b>
Ayşegül Acar <sup>1</sup> and Mehmet Erkan <sup>2</sup> .....	222
<b><i>How Alcoholic Beverage Etiquette Can Increase Sales .....</i></b>	<b>224</b>
Adam Carmer.....	224
<b><i>Corporate Environmental Policy Adoption and Environmental Disclosure: The Impact of Board Characteristics and Executive Compensation .....</i></b>	<b>225</b>
Rose Sebastianelli and Nabil Tamimi.....	225
<b><i>Licensing for Cooks and Bakers in the State of Florida .....</i></b>	<b>228</b>
Garry Colpitts.....	228
<b><i>How Do Millennials Select Restaurants? .....</i></b>	<b>229</b>
Bendegul Okumus, Sevil Sonmez, and Ahmet B. Ozturk.....	229
<b><i>Chinese Cruise Customers Loyalty: The Impact of Customer Participation and Service Personal Values .....</i></b>	<b>230</b>

Hui Wu <sup>1</sup> , Xiaoxiao Lv <sup>2</sup> , Muhittin Cavusoglu <sup>3</sup> , and Cihan Cobanoglu <sup>4</sup> .....	230
<b><i>'Fake News' in the Travel and Tourism Domain: An Investigation of the Phenomenon and Challenges for the Industry</i></b> .....	<b>231</b>
Giancarlo Fedeli .....	231
<b><i>Cruise Ships' Safety Measures and Their Influence on Passengers' Sense of Security and Purchase Intention</i></b> .....	<b>233</b>
Shadi Bahattab, Shiang-Lih Chen McCain, Jeff Lolli, and Joy Dickerson .....	233
<b><i>An Investigation of the Relationship Between Noise Level and Customer Satisfaction in the Restaurant Industry</i></b> .....	<b>234</b>
Tak Ming Yeung, Shiang-Lih Chen McCain, and Jeff Lolli .....	234
<b><i>Are Corruption and Insurgency Nemesis of Tourism Development? Evidence From Nigeria</i></b> .....	<b>235</b>
Uju Violet Alola <sup>1</sup> , Turgay Avci <sup>2</sup> , Ali Ozturen <sup>1</sup> , and Andrew Adewale Alola <sup>2</sup> .....	235
<b><i>Hotel Comment Card Reviews: A Model Proposal for Predicting Aspect Rating</i></b> .....	<b>236</b>
Abdullah Tanrısevdi <sup>1</sup> , Gözde Öztürk <sup>1</sup> , and Ahmet Cumhur Öztürk <sup>2</sup> .....	236
<b><i>Why Do German Tourists Still Come Despite Security Problems? A Case Study in Kusadasi, Turkey</i></b> .....	<b>240</b>
Büşra Hafçı and Abdullah Tanrısevdi .....	240
<b><i>Photographs in the Field of Sustainability: Some Preliminary Findings</i></b> .....	<b>245</b>
Lorenzo Gelmini .....	245
<b><i>Peace Agreement Affecting Risk Perception and Travel Intention</i></b> .....	<b>246</b>
Natalia Zapata Cuervo and Paula Florez-Gomez .....	246
<b><i>Human Resource Management</i></b> .....	<b>247</b>
<b><i>Assessing the Barriers to Effective Hospitality Internship in China</i></b> .....	<b>248</b>
Caiwei Ma <sup>1</sup> , Po-Ju Chen <sup>2</sup> , Lianping Ren <sup>3</sup> , and Tingting Zhang <sup>2</sup> .....	248
<b><i>The Measure of Emotional Intelligence in Leaders</i></b> .....	<b>249</b>
R. Douglas Waldo, Madison Clark, and Robert B. Wharton.....	249
<b><i>Workplace Violence: Awareness and Prevention</i></b> .....	<b>251</b>
Suzanne Crampton .....	251
<b><i>The Relationship Between Perceived Organizational Support, Organizational Commitment, and Job Satisfaction</i></b> .....	<b>254</b>
Christine Bellido <sup>1</sup> , Sonya Bosanko <sup>1</sup> , Laurie Burcaw <sup>1</sup> , Kelly De Freitas <sup>1</sup> , William Paczkowski <sup>2</sup> , and Russell Clayton <sup>1</sup> .....	254

<b><i>Innovation &amp; Entrepreneurship</i></b> .....	<b>257</b>
<b><i>Using the 2030 Goals to Create Global Perspective When Teaching in Business and Innovation</i></b> .....	<b>258</b>
Paul M. Lane <sup>1</sup> and Ryan Lafferty <sup>2</sup> .....	258
<b><i>Implementing Project Management Methodologies in Social Entrepreneurship Initiatives in Developing Nations: Methodology for Training SE Project Managers and Two Case Studies</i></b> .....	<b>261</b>
Raul Chavez.....	261
<b><i>International Trade &amp; Management</i></b> .....	<b>264</b>
<b><i>Business Relations in the Global Economy “What is Good Corporate Citizenship?”</i></b> .....	<b>265</b>
Ernest E. Pegram.....	265
<b><i>Lessons From the Project Management Field: The Search for Most Effective Methods for Successful Turn-Key Project Execution</i></b> .....	<b>266</b>
Ildiko K. Nyeste and Ramakrishna Govindu.....	266
<b><i>Design for Participation: Modular Service Approach</i></b> .....	<b>268</b>
Syed Aamir Ali Shah <sup>1</sup> and Muhammad Shakeel Sadiq Jajja <sup>2</sup> .....	268
<b><i>Marketing</i></b> .....	<b>270</b>
<b><i>The Impacts of Merchant Photos on Consumers’ Purchase Probability on P2P Short-Term Rental Platform: Based on the Mediated Effect of Initial Trust</i></b> .....	<b>271</b>
Hui Wu <sup>1</sup> , Jing Chen <sup>1</sup> , Muhittin Cavusoglu <sup>2</sup> , and Cihan Cobanoglu <sup>3</sup> .....	271
<b><i>The Effect on Consumer Attitude of SMS Advertising</i></b> .....	<b>273</b>
Remzi Reha Durucasu.....	273
<b><i>Reviewing CSR Promotional Communication Strategy in Hospitality Industry: Analyzing A Case Study</i></b> .....	<b>274</b>
Aysegul Songur.....	274
<b><i>Strategy &amp; Global Trends</i></b> .....	<b>277</b>
<b><i>Effects of Perceived Authenticity on Festival Attendees’ Loyalty: The Moderating Role of Motivation</i></b> .....	<b>278</b>
Hyeongjin Jeon <sup>1</sup> and Juwon Choi <sup>2</sup> .....	278
<b><i>International Collaboration Management</i></b> .....	<b>280</b>
Brent J. Cunningham and Dan Mertens.....	280

<b><i>Can New Strategies Keep Universities from Going Bust? .....</i></b>	<b>282</b>
Chandra Aleong .....	282
<b><i>Factors Influencing Outbound Medical Travel From the USA .....</i></b>	<b>282</b>
Ayse Collins <sup>1</sup> , Anita Medhekar <sup>2</sup> , Ho Yin Wong <sup>3</sup> , and Cihan Cobanoglu <sup>4</sup> .....	282
<b><i>Technology, E-Business &amp; Social Media .....</i></b>	<b>286</b>
<b><i>Investigating the Impact Factors to Influence Online Room Rebooking Intentions in Taiwan .....</i></b>	<b>287</b>
Tsong-Zen Liu <sup>1</sup> , Tai-Yi Huang <sup>2</sup> , and Hui-Hsin Kuo <sup>1</sup> .....	287
<b><i>The 5th Science &amp; Technology Foresight in South Korea: Discovering Future Technologies to Solve Major Issues of Future Society.....</i></b>	<b>289</b>
Jonghwa Park .....	289
<b><i>Collective Intelligence and Decision Making: Method and Its Application in Preliminary Feasibility Analysis of Public R&amp;D Program in Korea.....</i></b>	<b>294</b>
Sung-Ho Cho .....	294
<b><i>The Power of Engagement: Uncovering Social Media’s Return on Investment .....</i></b>	<b>299</b>
Elizabeth Yost, Tingting Zhang, and Ruoxi Qi .....	299

# *Part 1: Consumer Behavior*

# The Types and Motivation of Social Network Users: A Qualitative Study of Young Adults

Jamil Hebali

Ecole hôtelière de Lausanne, HES-SO  
University of Applied Sciences Western Switzerland

## Abstract

The objective of this research is to understand the motivation of social network users aged 18-24. Based on qualitative research and content analysis, this study proposes to understand their behavior and what motivates them to use social networks. Our main finding in this research is a motivation-based typology of social networks users and their psychological profile.

**Keywords:** users networks typologies, consumer behavior, qualitative research

## Introduction

Social networks have grown significantly as users interact more and more. Social networks are considered an extremely powerful tool for communicating and managing customer relationships. The number of users and amount of content generated through interacting, sharing and publishing on social networks have grown considerably in the last few years (Boyd & Ellison, 2008). Worldwide, there are over 2.16 billion monthly active Facebook users for Q4 2017 which is a 14 percent increase year over year. (Statista, 2018). Every 60 seconds on Facebook: 510,000 comments are posted, 293,000 statuses are updated, and 136,000 photos are uploaded. (The Social Skinny, 2017). Twitter has recorded more than 330 million users since its inception in 2006 and has more than 1.6 billion searches per day (Statista, 2018).

For businesses, this offers a huge opportunity to develop customer relationships through marketing and communication strategy involving social networks. In marketing, multiple research papers have highlighted the role of social networks in developing companies' business and better understanding their environment (Pookulangara and Koesler, 2011; Tsimonis and Dimitriadis, 2013; Ghazali and Cai, 2014). In brand management, some research has tried to understand the role and the impact of social networks on brand perception and how consumers develop their opinion about the brand (Reyneke, Pitt and Berthon, 2010, Both and Ann Matic, 2011, Lipsman, Mudd, Rich and Bruich 2012, Botha, Farshid, and Pitt, 2011). Other studies have tried to understand the role of social networks as a source of innovation and creativity in terms of product development and service quality improvement (Ernst Brem, and Voigt, 2013). In the field of consumer behavior, research has focused on users' motivation to use social networks (Kim, Shim and Mo Ahn, 2011). These studies have focused on one social network (Facebook, Twitter, LinkedIn, etc.) at a time while overlooking users' motivation with a global vision independently of the type of social network.

Our research will focus on social networks users' motivation. Two main points differentiate this research. On the one hand, our research will be conducted among young people between 18 and 24 years of age. We choose this age group because it is the biggest group of social network users and, at the same time, it is the group with highest time spent on social networks with an average

of 5 to 6 hours per day (Statista, 2018). On the other hand, our research will not be limited to one specific social network but all of them.

## **Literature Review**

For many researchers, motivation is an important factor to understand and to explain consumer behavior (Deci and Ryan, 1987). Defined as the direction and intensity of the effort to earn a recompense (Weinberg and Gould, 1997), motivation is a driving force for an individual to perform an action. Two types of motivation can be identified in self-determination theory (Deci & Ryan, 1985). Intrinsic motivation, which refers to doing something because it is inherently interesting or enjoyable and for the pleasure that can be derived from it (Lee, Cheung and Chen, 2005). The second type is extrinsic motivation, which refers to doing something because it leads to a separable outcome such as obtaining a reward, improving one's performance at work or having economic promotions (Davis et al., 1992; Lee, Cheung and Chen, 2005). Most research on motivation has shown that the performance obtained and the quality of involvement can be very different when we adopt intrinsic or extrinsic motivations. When we are intrinsically motivated we are moved to act for the fun or challenge involved rather than because of external prods, pressures, or rewards. In theory, we identify intrinsic motivation between individuals, but in another sense, an intrinsic motivation exists between individuals and activities. In fact, people are not motivated to do the same activity or to be interested to perform the same tasks. On the other hand, when we are extrinsically motivated we seek separable rewards after an activity.

To conclude, there are two types of motivation that impact individuals' behavior. Intrinsic motivation related to an emotional value to do an activity and extrinsic motivation which is related to an instrumental value. Both intrinsic and extrinsic motivation can be applied to the utilitarian-hedonic model in consumer behavior theory. The model suggests that hedonic behavior is a consequence of intrinsic motivation; however, utilitarian behavior is a consequence of extrinsic motivation (Heijden, 2004). The utilitarian-hedonic model suggests that the consumer may adopt utilitarian motivation or hedonic motivation based on the nature of the product (Babin, Darden and Griffin 1994, Guiltinan and Monore 1980). Consumers with utilitarian motivation follow a rational behavior. From the beginning, they have a specific goal and will try to achieve it conscientiously. For example, when consumers search for information in the decision making process, they adopt utilitarian motivation because the objective is to maximize the usefulness of their decision and therefore reduce the associated risk (MacInnis and Jaworski, 1989). Thus, a utilitarian system involves goal-oriented behavior characterized by a focus on a specific objective defined in advance by the consumer. On the other hand, hedonic motivation aims at seeking stimulation, excitement, gratification, pleasure and discovering new feelings (Babin, Darden and Griffin, 1994). The hedonic system is characterized by experiential, personal, and subjective behavior (Holbrook and Hirschman, 1982).

### *Social Networks and Motivation*

Despite the fact that the number of social media users continues to grow to over 1.5 billion worldwide, research to understand users' motivation for using social media is still limited. Indeed, the little research carried out to date has mainly focused on specific issues. Hsieh, Yang and Fu (2012) studied the role of motivation as a variable impacting the switching behavior within different social networks. The aim for the authors was to explain the intention to change from one

network to another, taking into account the cost generated as a moderating variable between the antecedent variables that are the relative utility, the effectiveness of the expression and playfulness. In information system theory, some research has shown that social networks users with intrinsic motivation expect more emotional rewards compared to users with extrinsic motivation (Kim, Shim and Mo Ahn, 2011). Regarding the youth population, some research has shown that the motivation of high school students to use social networks was mainly to communicate and exchange with colleges, friends and family (Lenhart and Madden 2007). This type of motivation is supported by the ease of use of social networks (Kim, Shim, & Ahn, 2011). For the authors, using social networks is a new manner for people to manage their relationships.

On the other hand, another motivation of young people is their need to develop their career after their studies. In fact, social networks for them are a very simple tool to develop their network, to search for a job opportunity and to be continuously informed about the job market (Schaefer, 2008). Social networks, by their simplicity and their high level of interactivity and socialization, has changed the way in which people communicate, exchange, participate and discuss with others on a specific forum (Kim, Shim, & Ahn, 2011). For users, social networks are an opportunity to express themselves through the creation of their own pages, personalized website, or to create their own video channel on social media (Pelling & White, 2009). This activity will bring them recognition (Miller, Parsons, & Lifer, 2009), allow them to create and to be a part of a community. At the same time, social networks provide an opportunity to "escape" reality, boredom and relieve stress by sharing emotions (Kim, Shim, & Ahn, 2011). It is relevant to note that motivations are different among women and men. As an example, man looking to meet friends, appreciate the interactivity of social networks, while easily identifying with a group. A woman will appreciate the relational side of social networks, which will allow her to keep in contact with her close friends and family (Barker, 2009)

### *Research Question*

This research has two main objectives. The first objective is to identify the motivations of young people aged 18-24 related to their use of social networks. The second objective is to develop a typology of social network user according to their motivations. Therefore, a psychological profile of each group will be defined. Thus, we will try to answer the following questions: What are the motivations of 18-24 year olds when it comes to using social networks? Are there different types of users? In this research, we chose to study 18-24 year olds for many reasons. On the one hand, this population is considered the largest users of social networks which represent around 30% of total users. Furthermore, they have to spend an average of 4 to 6 hours per day on social networks. On the other hand, this age group is part of the Y generation, which represents more than 50% of the world's population and therefore forms a future market for companies. For all these reasons, it is urgent to study it and understand its behavior.

### **Methodology**

As our aim is to explore the motivations of social network users aged between 18 and 24. This research will be based on a qualitative approach by conducting face-to-face, semi-structured interviews. Qualitative research is a relevant approach as it puts emphasis on the depth of the analyses which will lead to rich descriptions of participants' meanings based on in-depth interviews (Denzin & Lincoln, 2003).



## *Sampling*

In our recruiting process, we chose participants that they are in the 18-24 age group. This type of profile is described as the most active social network user, and also has a high motivation to explain and share their social network experience (Hargittai and Hsieh, 2010). Our recruitment process was done using social networks such as Facebook and LinkedIn. Using our own accounts on those two social networks, an announcement was posted asking people having our target profile with a high interest to participate to our research. Through our network we received 27 positive answers to participate. By the end, 24 face-to-face interviews were conducted include 12 men and 12 women with an average age of 22 years. After 20 interviews, answers collected became redundant and some repetitions were identified. We added four other interviews in order to confirm data saturation in line with the standards of qualitative research (McCracken, 1993).

## *Data Collection*

All interviews were done face-to-face. With each participant an appointment was fixed. A meeting room was booked for all interviews. The researcher paid the transportation for all participants and a symbolic gift was given. The interviews lasted between 30 and 45 minutes on average and were recorded with the consent of the participants. An interview guide was developed to conduct the discussion with open-ended questions. The interview guide was structured by theme based on our research objectives. The interview guide was structured by topic of discussion. The motivation for the use of social networks was the main theme addressed during the interview. Added to this are other themes such as:

- Usage behavior of social networks (frequency of use, number of hours of use on average, main activities, etc.) The objective here is to define different user profiles according to their degree of use.
- Self-image: Each participant in our research has to describe his self-image. i.e. what he or she thinks of him/herself. The objective is to analyze if there is a relationship between self-image and the motivation. The objective is to identify if the self-image or self-esteem have an impact on the behavior of social network users and on their motivation (Barker, 2009) and the role of the self-image to facilitate interactions and communication between users (Ferguson, 2017). The results will allow us to develop the psychological profile of each group based on their main motivation, behavior and self-image.
- The socio-demographic profile: since the entire sample has almost of the same age, the main objective here was to check whether there is a difference in the motivations and the behavior of use of the social networks mainly between women and men. A confidentiality letter was signed by the researcher and a copy was given to the participants in order to guarantee the anonymity of all data collected.

## *Data Analysis*

The data analysis method was carried out through traditional interactive and systematic content analysis (Churchill and Wertz, 1985; Clairbrone and Ozanne, 1990). Specifically, data analysis consisted in the following stages: We started by scanning interview transcripts. The objective was to develop an initial understanding for the formulation of our research hypothesis through a process

of induction (Bardin, 1977). A traditional structural analysis of the content was then conducted on the basis of all data collected. This analysis give us an initial understanding of the motivations of social network users and consequently identify the main dissimilarities. Based on different motivations and reasons given by participants we developed a motivation-based typology. Following this analysis, the core categories extracted from the literature review such as intrinsic and extrinsic motivation or hedonic or utilitarian motivation were compared to the data obtained in order to identify if there is a gap between the theory and our analysis. The second phase of data analysis was focused to identify a motivation-based typology of social networks users. The third step of our data analysis was focused on developing a psychological profile of each type of social network user identified before. This profile included mainly three points: Main motivation, the specific behavior and the self-image. In order to facilitate the explanation of results, we proceeded in the tradition of qualitative research by using verbatim statements to illustrate each part of our findings (Wolcott, 1990)

## **Findings**

Our analysis confirmed, as developed in our literature review, that there were two main motivations that push young people to use social networks. The first one is intrinsic motivation where people seeking pleasure, discovery and enjoyment when they use social networks. For this type of motivation, we can identify one group that they are more interested by creating relationships. For them, social networks are a new way to socialize and to exchange with people in a virtual manner. Another group of our participants perceive social network as a tool to flee the real world. For them, social networks are a manner to discover and to have a good time. The second is extrinsic motivation where people look to gain from their activities on social networks such as developing their network, find a job, be informed about something, etc.

Thus, three types of social network users are identified. The first group identified as "social" is motivated by developing, maintaining and manage their relationships with friends, family and other contacts. They always look to have news from their contacts, exchange with them about different subjects such as family, culture, sports, etc. They are very interested in sharing information about their situations or the activities they have done or plan to do in the future. For them, social networks can be viewed as an important tool for building relationships with new friends. One participant confirmed that "Social networks are really an extraordinary invention, it allows me to be in touch with my friends and family all the time. It's easy and it allows me to hear continuously about what they are doing. Whenever a member goes on vacation, he shares those photos, videos and information with us". For this group, social networks are also a tool to socialize in the same way as the off line environment. Another participant confirmed that "I have some family members who work in different countries, and despite the distance that separates us, we are always in contact and we exchange news, everyone knows what the other is doing...as if we were together, I would even say that if we were together we will not be close in this way, it's the magic of Facebook I think." For this group, social relationships are extremely important and they are always looking to maintain their contact as in the real world. Another participant confirmed that "Social networks allow me to share news with my family and friends in a different format, such as, image, text and video. Personally, I am very close to my sister working in the United States, before we had a lot of contact by phone, but since we have Facebook we share everything on the network, in fact it is more convenient, it allows me to see what that she is up to, what she does through images and videos, it's really cool, exactly the same as we're together. "

**Table 1.** Psychological Profile of the Segment «Social»

<i>Main Motivation</i>	Manage, interact and exchange with their private relationships
<i>Behavior</i>	Exchange private information and share content such as pictures, video, music, etc. Organize events with friends through social network They spend between 3 and 4 hours connected and interact with their friends on social networks.
<i>Self-image</i>	They describe themselves as social people, open-minded, optimistic and very sensitive
<i>Social Networks</i>	Facebook, Twitter, Instagram.

The second group identified as "Functionalists". Their main motivation is to develop and manage professional contacts and career networking. Thus, their objectives are, on the one hand, to improve a professional network and to develop their contacts. On the other hand, it is about being always active on their own career development by looking for new opportunities through the contacts they have developed on the networks. One participant confirm that "I have a friend who managed to get a job through a social network, at first I did not believe much in this solution, but since then I'm really starting to get interested. I think social networks offer a new job search opportunity in a more interactive way and with new methods such as posting a CV in video form, I find it very original. «Another one add that «For me social networks and mainly the professional ones are an excellent opportunity to develop my career ambitions. I connect every day on LinkedIn, I do not spend a lot of time, but I try to find out about new job offers and manage my network that I think one day will be useful in my development careers. We never know how the opportunity can arise, that's why I heal every word I put on my profile". Functionalists take care about their image and try to be perceived as professional and efficient. Their interaction on social networks are more focus on professional exchange, participate in some discussion and give their opinion about some topics such as technology, economy and politics, etc.

**Table 2.** Psychological Profile of the Segment «Functionalists»

<i>Main Motivation</i>	Develop a professional network
<i>Behavior</i>	No communication and no exchange about private life. Social networks is considered a tool to promote their career and their professional image They try to be continuously informed about the changes in the job market and the career evolution of their network They take more time to do any comments or to post any information because they are aware that this will reflect their own image Average time of connection per day: between 1 and 2 hours
<i>Self-image</i>	Describe themselves as hardworking people, ambitious with a lot of willpower.
<i>Social network</i>	LinkedIn, Viadeo, facebook

The third group is "hedonists". The main motivation of this group is seeking entertainment, fun and pleasure. For them, social networks are a way to entertain themselves by sharing information in different formats such as images, videos and texts that generally include funny content. It is a very active group on social networks as they seek to be the first to share or comment on entertaining and fun content. Using social networks and spending time for it is a manner to reduce stress, to discover, to have emotional experience, etc. One participant confirmed that "I am continuously connected. For me it is very important to be in touch with my friends all the time. Nowadays it is very difficult to find time to see my friends and to share some fun moments. Social networks reduce a lot my frustration, because it is another manner for me to interact with my friends and my family. It is very easy to share information and to have a nice moment, even it is virtual, but it is better than nothing. It doesn't replace the real world but it is for me a good way to be continuously in touch." Another participant confirmed: "It is really a good way to reduce the stress after a

workday. For me it is like another world in parallel, when I connect I am always excited to find a funny publication and humoristic video or image, etc.” For this segment, social networks are also a new manner to help them to make a decision before buying something. Their interactions with their friends and share opinion about their own experience help them to make the good decision.

**Table 3.** Psychological Profile of the Segment «Hedonists»

<i>Main Motivation</i>	Seeking entertainment, fun, discovering and pleasure
<i>Behavior</i>	They exchange and communicate on entertaining and fun multimedia content. They are very active users and try to be the first to comment on others' publications and share them. Connecting to social networks for them is a way to reduce stress, to discover and create emotional experience with others The average connection time for this group is 3 to 4 hours per day.
<i>Self-Image</i>	They perceive themselves as a sociable people, dynamic and very important in their social networks.
<i>Social Networks</i>	Facebook, Twitter, digg

This research gives us an in-depth understanding regarding the motivations of the 18-24 year old segment and their behavior on social networks. Our analysis identifies three groups of users with the same demographic profile but with different behaviors in terms of social networks use. The first one is the social cluster, they are motivated by staying in contact and maintaining their relationships with their friends and family. The second one is the hedonists’ cluster who are mainly motivated by entertainment and delight. These two groups have an intrinsic motivation with an experiential behavior. Both clusters are seeking emotional sensations and discovery. Through their interaction they try to explore new experiences and adventures. They are in search of entertainment, fantasy, arousal, sensory stimulation, and enjoyment, fun and pleasure through social networks. On the other hand, the functionalists are mainly motivated by professional objectives such as the development of their careers and their networks. This cluster has an extrinsic motivation which supposes that they have a utilitarian behavior when they use social networks. They are seeking to develop their networks and their professional contacts. Users are concerned with their career development and their professional image in an efficient and timely manner to achieve their goals with a minimum of irritation. The results obtained in our research are perfectly in line with many other researchers (Hoffman and Novak's; 1996; Hirschman and Holbrook, 1982; Sherry, McGrath and Levy, 1993). Indeed, the authors evoke an experiential behavior and a behavior directed towards a goal. The first is driven by a hedonic and exploratory motivation, while the second is driven by a utilitarian motivation.

### **Conclusions, Limitations and Further Research**

Social networks provide young people with the opportunity to identify within group members who look and act similarly to each other. In our research, three main groups of social networks users based on their motivation are identified, social, functionalist and hedonic groups. This typology gives us a better understanding of their motivation and their behaviors with regard to social network use. The majority of the participants in our research show a real attachment to social networks with a high level and frequency of use, which can be considered a business opportunity for many companies. Indeed, this population is a strategic target for marketing actions and therefore building strong relationships and developing positive attitudes toward the brand is important. Identifying how this market segment interacts with the social networks and how they

describe themselves it can be a good opportunity for many companies to develop a very efficient customer acquisition strategy and to better manager customer relationships.

The focus of this research is to understand young people's motivation and their post-adoption behavior with regard to social network use. Many limits can be identified in our research. Firstly, our concept of psychological profile is limited with three main variables such as motivation, behavior and self-image. This profile do not take in consideration other psychological variables such as perception, involvement or attitude. As an example, the role of perceived risk as a source of resistance to innovation or new product adoption and the risk related to the use of social networks such as personal image and reputation were not studied in this research. On the other hand, this research did not take into account the impact of the atmosphere variables such as the ease of use, the ergonomic, the design and the structure of the social network website on the users' behavior (Donthu, 2001; Tam Tsui Wa, 2001; Koufaris, 2002; Roy, Montoya-Weiss, Voss and Grewal 2003). As defined in our methodology this research focused on the young adults from 18 to 24 years old. Our sample is from the same geographical region (Switzerland and France) and the results obtained cannot be generalized for the whole population of 18-24 years old and our results implications were limited. This is can be explained with the difference in the culture and social environment between many regions in the world and consequently between this segment of the population.

## References

- Babin, B., Darden, W., & M, G. (1994). Work and/or fun: Measuring hedonic and utilitarian Shopping Value. *Journal of Consumer Research*, 20(2), 644-656.
- Bardin, L. (1977). *L'analyse de contenu*. Presses Universitaires de France.
- Barker, V. (2009). Older adolescents' motivations for social network site use: The influence of gender, group identity, and collective self-esteem. San Diego: School of Journalism and Media Studies, San Diego State University.
- Booth, N., & Ann Matic, J. (2011). Mapping and leveraging influencers in social media to shape corporate brand perceptions. *Corporate Communications: An International Journal*, 16(3), 184-191.
- Botha, E., M, F., & L., P. (2011). How sociable? An exploratory study of university brand visibility in social media. *South African Journal of Business Management*, 42(2), 43-51. .
- Boyd, D., & Ellison, N. (2008). Social Network Sites: Definition, History, and Scholarship. *Journal of Computer-Mediated Communication*, 13, 210-230.
- Churchill, S. D., & Wertz, F. J. (1985). An Introduction to Phenomenology for Consumer Research: Historical, Conceptual and Methodological Foundations. *Advances in Consumer Research*, 12, 550-554.
- Clairbone, A., & Ozanne, J.-L. (1990). The meaning of Custom-Made Homes: Home As a Metaphor For Living. *Advances in Consumer Research*, 17, 367-374.
- Davis, F., Bagozzi, R., & P.R., W. (1992). Extrinsic and intrinsic motivation to use computers in the workplace. *Journal of Applied Social Psychology*, 22(14), 1111-1132.
- Deci, E. L., & Ryan, R. M. (1985). *Intrinsic motivation and self-determination in human behavior*. New York: Plenum.
- Deci, E. L., & Ryan, R. M. (1987). The support of autonomy and the control of behavior. *Journal of Personality and Social Psychology*, 53(6), 1024-1037.
- Denzin, N. K., & Lincoln, Y. S. (2003). Introduction: The discipline and practice of qualitative research. In C. Sage. (Ed.). Thousand Oaks: Denzin & Y. S. Lincoln (Eds.), (2nd ed.).
- Denzin, N. K.-4. (n.d.). Thousand Oaks.
- Donthu, N. (2001). Does Your Web Site Measure Up? *Marketing Management*, 10(4), 29 – 33.
- Ernst, M., Brem, A., & Voigt, K. I. (2013). Innovation Management, Lead-Users, and Social Media,. In *Introduction of a Conceptual Framework for Integrating Social Media Tools in Lead-User Management*. Social Media in Strategic Management Advanced Series in Man.

- Ferguson, J. R. (2017). Journal of Managerial Issues. Self-Image Congruence: An Empirical Look at Consumer Behavior in Door-to-Door Sales!, XXIX(3), 262-277.
- Ghazali, R. M., & Cai, L. (2014). Social Media Sites in Destination Image Formation. *Tourism Social Science Series*, 18, 73–86.
- Guiltinan, J., & Monroe, K. (1980). Identifying and analyzing consumer shopping strategy. *Advances in Consumer Research*, 25, 372- 378.
- Hargittai, E., & Hsieh, Y. L. (2010). Predictors and consequences of differentiated practices on social network sites. *Information, Communication, & Society*, 13(4), 515–536.
- Heijden, D. (2004). User Acceptance of Hedonic Information Systems. *Management Information Systems Quarterly*, 28(4), 695-704.
- Hoffman, D., & Novak, T. (1996). Marketing in hypermedia computer-mediated environments: Concepts foundations. *Journal of Marketing*, 60(3), 50 – 68.
- Hoffman, D., Novak, T., & Chatterjee, P. (1997). Commercial Scenarios for the Web: Opportunities and Challenges. In R. K. in *Readings in Electronic Commerce* (Ed.). (Addison-Wesley, Reading).
- Holbrook, M., & Hirschman, E. (1982). The Experiential aspects of Consumption: Consumer fantasies, feelings and fun. *Journal of Consumer research*, 9(2), 132 – 140.
- Hsieh, C., K., Y., & K.J, F. (2012). Motivational Bases and Emotional Labor: Assessing the Impact of Public Service Motivation. *Public Administration Review*, 72(2), 241–251.
- Kim, J., Shim, J., & Mo, A. K. (2011). Social Networking Service: Motivation, Pleasure, and Behavioral Intention to Use. *Journal of Computer Information Systems*, 51(4), 92-101.
- Koufaris, M. (2002). Applying the technology acceptance model and flow theory to online consumer behavior. *Information Systems Research*, 13(2), 205 – 223.
- Lee, M. K., Cheung, C. M., & Chen, Z. (2005). Acceptance of internet-based learning medium: the role of extrinsic and intrinsic motivation. *Information & Management*, 42(8), 1095-1104.
- Lenhart, A., & Madden, M. (2007). Social Networking Websites and Teens, Pew Research Center. Retrieved from <http://www.pewinternet.org/2007/01/07/social-networking-websites-and-teens/>.
- Lipsman, A., Mudd, G., M., R., & Bruich, S. (2012). The Power of “like”: How Brands Reach (and Influence) Fans through Social-Media Marketing. *Journal of Advertising Research*, 52(1), 40-52.
- MacInnis, D., Jaworski, B., & J Mark. (1989, October). Information processing from advertisements: Toward an integrative framework. *Journal of Marketing*, 53, 1–23.
- McCracken, G. (1993). The Value of the Brand: An Anthropological Perspective in Brand Equity and Advertising. (D. A. (eds.), Ed.) Hillsdale, NJ: Lawrence.
- Miller, R., Parsons, K., & Lifer, D. (2009). Students and social networking sites: the posting paradox. *Behaviour & Information Technology Journal*, 377-382.
- Montoya-Weiss, M. M., Glenn, B. V., & Dhruv, G. (2003). Determinants of Online Channel Use and Overall Satisfaction with a Relational Multichannel Service Provider. *Journal of the Academy of Marketing Science*, 31(4), 448-458.
- Noyes, D. (2018). The Top 20 Valuable Facebook Statistics. *The Social Skinny* . Retrieved from <https://zephoria.com/top-15-valuable-facebook-statistics/>
- Pelling, E., & White, K. (2009). The theory of planned behavior applied to young people's use of social networking Web sites. *Cyberpsychology & Behavior*, 12(6), 755-9. .
- Pookulangara, S., & Koesler, K. (2011). Cultural influence on consumers' usage of social networks and its' impact on online purchase intentions. *Journal of Retailing and Consumer Services*, 18, 348–354.
- Reyneke, M., Pitt, L., & Berthon, P. R. (2010). Luxury wine brand visibility in social media: an exploratory study. *International Journal of Wine Business Research*, 23(1), 21-35.
- Roy, M., Dewit, O., & Aubert, B. (2001). The impact of interface usability on trust in the web retailers. *Electronic Networking Applications and Policy*, 11(5), 388 – 398.
- Schaefer, C. (2008). Motivations and Usage Patterns on Social Network Sites. *ECIS 2008 Proceedings*, (p. Paper 143). Retrieved from <http://aisel.aisnet.org/ecis2008/143>
- Schiffman, L. G., & Kanuk, .. (2007). *Consumer Behavior* (9ème édition ed.). Pearson education.
- Sherry, J., McGrath, M., & Levy, S. (1993). The Dark Side of the Gift. *Journal of Business Research*, 28, 225-244.
- Statista. (2018). Active social network and active app users, Worldwide; GlobalWebIndex; 3rd quarter 2014; 16-64 years. Retrieved from <https://www.statista.com/statistics/274829/age-distribution-of-active-social-media-users-worldwide-by-platform/>
- Statista. (2018). Number of monthly active Facebook users worldwide as of 4th quarter 2017 (in millions). Retrieved from <https://www.statista.com/statistics/264810/number-of-monthly-active-facebook-users-worldwide/>

- Steuer, J. (1992). Defining virtual Reality: Dimensions Determining Telepresence. *Journal of Communication*, 5(5), 21 – 39.
- Tam Tsui Wa, C. (2001). An integrated online customer loyalty model. The Honk Kong Polytechnic University, Department of Business Studies, , Hung Hom, Kolwoon, Honk Kong. . Retrieved from [http://www.sba.muohio.edu/abas/2003/Brussels/tam-pb-6310christinetam.pdf].
- Tsimonis, G., & Dimitriadis, S. (2013). Brand strategies in social media. *Marketing Intelligence & Planning*, 32(3), 328-344.
- Vanden, B., Bruce, G., M., L., Quilliam, E., & T., H. (2001). The multidimensional nature and brand impact of user-generated ad parodies in social media. *International Journal of Advertising*, 30(1), 103-131.
- Weinberg, R., & Gould, D. (1997). *Psychologie du sport et de l'activité physique*. (É. Vigot., Ed.) Paris.
- Wolcott, H. (1990). *Writing Up Qualitative Research* (20). (A. S. Paper., Ed.) Qualitative Research Methods Series.

# New Digital Currency and Technological Transformation

Massimiliano Minaudo

University of Palermo, Italy

## Abstract

In 2009 the cryptocurrency was born, a digital currency, re-launched in the world as "BitCoin" (although now there are about 30) which is the "mother", the original one. The problem that I want to highlight is the absence of some authorities able to control cryptocurrencies, so, for transactions and for the release of new coins because everything happens according to uncontrolled exchanges, moreover, the sale through the Internet 'anonymity not ad hoc protection on an online transaction. The alarm that wants to launch the cryptocurrency and therefore the BitCoin system. The purpose of this research started from the issue of the pages, in fact, since the creation of the digital currency has been used a completely new and, in some ways, unknown called "mining" (technically equal to the first non-trivial and not negligible), a "brute force". To avert the probability that the CPU (a central processing system) of a computer is exposed, perhaps with the inclusion in some pages of dangerous scripts, I will give some advice on 'a code for the code for the title that is going on.

**Keywords:** digital currency, bitcoin, transactions, dangers, wallet.

## Introduction



Figure 1. BitCoin

In 2009 the cryptocurrency was born, a digital currency (1MB blocks), known in the world as "**BitCoin**" (now there are about 30 all recognized and regulated) that is the "mother" (symbolized in figure 1). In the past it had been demonized due to the illegal trade that took place in the Deep / Dark Web (until the triumph in 2017). To validate exchanges (since it is recognized as an *equivalent currency*) and therefore to create it, the principles of cryptography are adopted in order to make online payments secure (quickly and anonymously).

To get a profit, just create a digital "**wallet**", which is always recommended to backup and encrypt it (among the software wallets we mention <https://bitcoincore.org/>; <https://greenaddress.it/it/> or <https://greenaddress.it/en/>; <https://btcarmory.com/>; for the well-known hardware wallet it is Ledger Nano S that stores more than 10 types of currencies (thanks to an LCD screen) as you can directly see on the site: <https://www.ledgerwallet.com/>), that is a file where you can save or store coins with programs available on the net as "Bitcoincore" (<https://bitcoin.org/en/download>), a sort of IBAN code (which is the hash of the public key that, together with the private key, gives access to the funds transferred to the wallet), formed by a string of 26-35 characters that those who want can generate it. To perform a transaction - non-cancelable - it takes a private key from the recipient that is converted into public and transformed into an address / IBAN sent to whom must make the payment. The transaction is placed in a block waiting to be confirmed by the miners and at the end of the process the receiver will be the owner of the currency sent by the sender.

The problem is that we are in the absence of any authority able to control the cryptocurrencies (since there are no precise checks, the only trick is that the monetary transfers are defined as



"change of ownership"), the transactions and even the release of these new coins because everything happens according to free trade, indeed, the "laissez-faire" and the sale through the Internet allow to remain anonymous, moreover, it reduces the exposure to confiscations that the police could possibly implement.

The trend is rather favorable, in the current year the value of 10,200 dollars has been exceeded and some startappers and startups (companies and joint-stock companies) are dedicated to this.

There is a **Bitcoin Foundation** that gathers several respected members and program developers to get money, however, without any direct power over relative value (or operation). The "official" site (under the MIT license) seems to be represented by "**Bitcoin**" (as you can see in figure 2).



Figure 2. "Official" Bitcoin site (<https://bitcoin.org/en/> or <https://bitcoin.org/it>)

To obtain this currency, just accept it as a form of payment (goods and services) or buy it even with a direct exchange made with your financial intermediary / bank account, in addition, the "**Bitcoin ATMs**" (with the "change" function) were created, for example, on Coin ATM Radar (<https://coinatmradar.com/>).

## Methodology

Observation of the phenomenon, survey of the population (survey), single case study, research, meta-analysis.

### *Issues: Empirical Data and Analysis*

During 2016/2017, **based on data collected on the net**, these coins have been a huge success especially thanks to the financial campaigns known under the name of "**ICO**" (Initial Coin Offering), that is, projects through which they were issued shares in exchange for virtual currencies (in December 2017 the value of a BitCoin has risen up to 20,000 dollars: 3,000% compared to 2016), which is why so many investors have been attracted to this innovative source of income. Today we are facing a new land where we can speculate.

However, there are also other crypts called "**Altercoins**". Let's talk about a coin that can be changed in legal tender currency (from the dollar to the yen and others) and converted, for this we must find a seller of BTC (which in return receives "fiat" / "legal" currency), thus, some automated Exchange services have arisen for trades; for example:

- <https://www.bitstamp.net/>
- or <https://www.coinbase.com/>
- and alternatively <https://www.coinbase.com/>
- or <https://www.binance.com/>.

The alarm to be launched (beyond independence) is that the cryptocurrency and consequently in the BitCoin system, to emit money, we use a whole new way of creation called "**mining**" that, technically, corresponds to a non-trivial note operation as "brute forcing", in other words, it refers to a specific algorithm able to solve a certain problem, specifically, it is a verification of three hundred sixty degrees of possible remedies or solutions that can be implemented until the correct set up or working. Wanting to make a summary of the research carried out, we can say that the intention is to be able to insert data (header of the block) whose double hash (mathematical algorithm that performs the mapping of data and allows the transformation of the same in a new string binary or message, known as "hash value", usually used for cryptography) is numerically lower than the target / objective calculated on the basis of the difficulty coefficient (a smaller target corresponds to a greater number of attempts to search for the number (if you want to invert a function, you must be able to recreate the input data from the output and this can be done through the already-known brute force). Basically, the computer on which the mining program is started receives the header in which a "nonce" number is added - and the double hash of the block to be closed has been calculated with an effectively configured client (operation known as " only "mining", alternatively, we proceed with the network or a server where it is sent (the header) for approval (phenomenon known as "pool" mining). Operations, of course, occur millions of times per second (as many as the MHash / sec reported by the mining program) and any hashing attempt may be the good one. It happens that transactions in a data structure are normally called "blocks" and stored by the aforementioned BitCoin network, however, to ensure that a block can be added to the rest of the block chain (to the public database containing all the trades) it takes a sophisticated hardware, that is, a good computer that can close everything with a code (rediscovered or uniquely successful with numerous attempts).

The operation described makes the block crystallized and therefore prevents any future changes, but be careful: those who find the code is rewarded with an undoubted amount of currency along with the transaction fees included in the block as a natural incentive to a donation of time machine dedicated to the cause of the cryptocurrency. This operation is called, in the jargon, "mining" and this name derives from the BitCoin-gold parallelism whose reciprocation consists of miners (those who tenaciously seek the gold nuggets in the rock).

In conclusion, to avoid the likelihood that the CPU (Central Processing Unit) of your computer is now exposed (by visiting some streaming sites for example) to the secret exploitation of computing capacity by inserting, in some pages, a JavaScript code for mining is advisable to run away with specific tools, many of which, which I could recommend, are free and powerful enough to monitor and record their execution.

Some *Mining Pool* services are listed on "*Bitcoin Wiki*" (figure 3) along with links and features; as software, the one most compatible with all platforms could be represented by "**BFGMiner**" (compatible with Windows / Linux: <http://bfgminer.org/files/latest/>) easy to use by anyone.

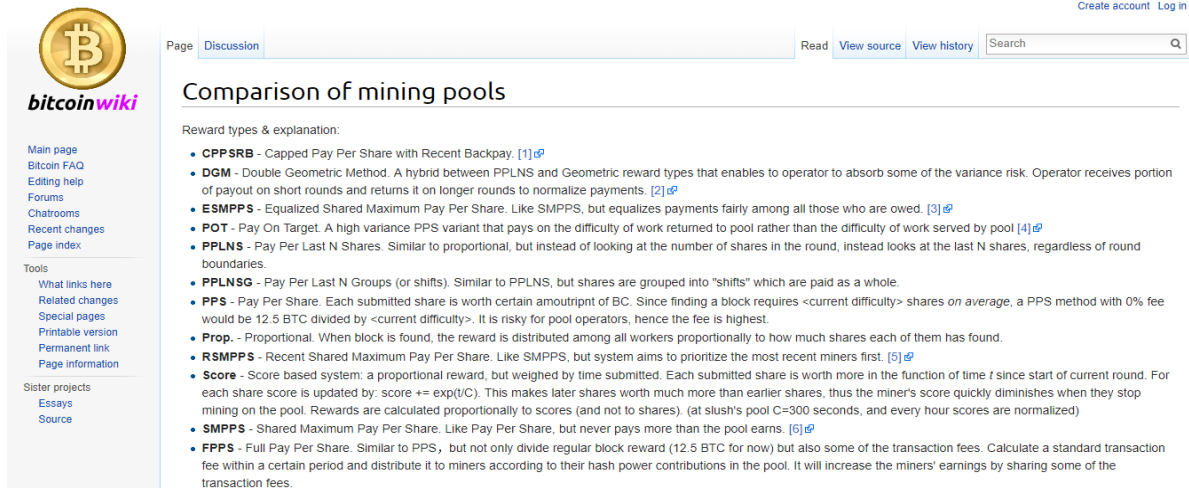

Figure 3. Bitcoin Wiki ([https://en.bitcoin.it/wiki/Comparison\\_of\\_mining\\_pools](https://en.bitcoin.it/wiki/Comparison_of_mining_pools))

In addition to the above we find "*Slushpool*" which, with the use of clients, acts by dividing the workload of the mining along with the coins "extracted" from the network with the other machines connected remotely (figure 4).

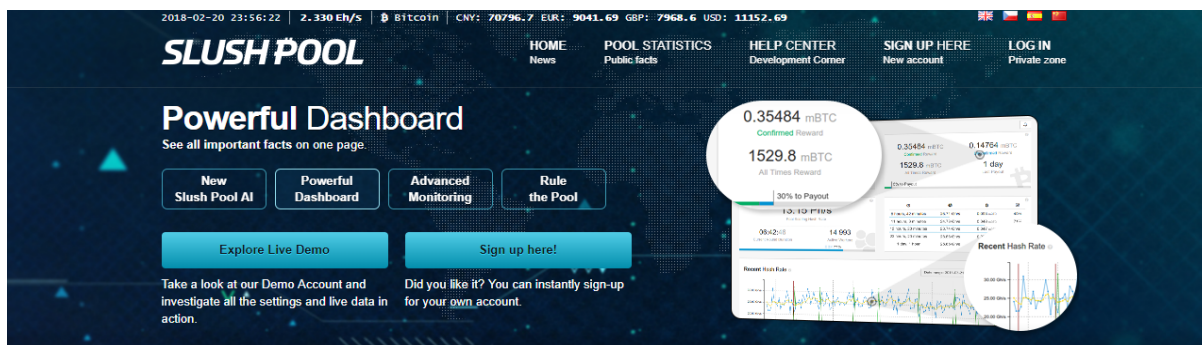

Figure 4. Slushpool – (<https://slushpool.com/home>)

A further system consists in using the **ASIC** (Application-Specific Integrated Circuit), that is, integrated circuits designed to quickly solve calculations (in this case, energy consumption are reduced).

It must be remembered that the instrument analyzed is not, however, to be "condemned", the use that has been made of it is however to be weighted.

To curb some of the many raids that we talked about and that can occur during navigation you can install and activate small but powerful extensions, among many we remember two, just as an example, both available on Chrome Web Store: **minerBlock** (blocks miners of cryptocurrency in the web with a double action, first, based on requests / scripts, subsequently, detecting abnormal behavior of the same) and **No Coin** (blocks miners who want to use the resources of the user, using as bridge the browser, without asking for consent and leave them a short period of time after which you must enter a captcha / shortlink).

- *The first one is available at this link*
  - [https://chrome.google.com/webstore/detail/minerblock/emikbbbebcdfohonlaifafn oanocnebl?utm\\_source=chrome-ntp-icon](https://chrome.google.com/webstore/detail/minerblock/emikbbbebcdfohonlaifafn oanocnebl?utm_source=chrome-ntp-icon)
- *The second one is available at this link*
  - [https://chrome.google.com/webstore/detail/no-coin/gojamcfopckidlocpkbelmpjcgmbgjcl?utm\\_source=chrome-ntp-icon](https://chrome.google.com/webstore/detail/no-coin/gojamcfopckidlocpkbelmpjcgmbgjcl?utm_source=chrome-ntp-icon)
- *Alternatively there is also the add-on for Firefox at this link*
  - <https://addons.mozilla.org/en-US/firefox/addon/no-coin/?src=userprofile>
- *or for those who use Safari.*
  - <https://itunes.apple.com/cz/app/1blocker/id1025729002?mt=8>

**Table 1.** Extensions List

Google Chrome	Mozilla Firefox
1. Tg Miner Block	2. CoinBlock
3. AntiMiner – Coin Miner Blocker	4. CryptoStop
5. CryptoStop	6. NoMiners
7. MinerBlock – Block Coin Miners	8. MineBlock
9. No Bitcoin miners	
10. No Mining – Block coin mining websites	
11. MinerStop	
12. Crypto Miner Blocker	
13. Miner Away	
14. Coin-Hive Blocker	

- *Source:*
  1. [https://chrome.google.com/webstore/detail/tg-miner-block/iomcmnojbebmjionkboendkbahihhaj?utm\\_source=chrome-ntp-icon](https://chrome.google.com/webstore/detail/tg-miner-block/iomcmnojbebmjionkboendkbahihhaj?utm_source=chrome-ntp-icon)
  2. <https://addons.mozilla.org/en-US/firefox/addon/coinblock/?src=search>
  3. [https://chrome.google.com/webstore/detail/antiminer-coin-miner-bloc/abgnbkcdbiafipllamhhmikhgjolhdaf?utm\\_source=chrome-ntp-icon](https://chrome.google.com/webstore/detail/antiminer-coin-miner-bloc/abgnbkcdbiafipllamhhmikhgjolhdaf?utm_source=chrome-ntp-icon)
  4. <https://addons.mozilla.org/en-US/firefox/addon/cryptostop/?src=search>
  5. [https://chrome.google.com/webstore/detail/cryptostop/amncjblhpopmnmcliddnlghifglabb?utm\\_source=chrome-ntp-icon](https://chrome.google.com/webstore/detail/cryptostop/amncjblhpopmnmcliddnlghifglabb?utm_source=chrome-ntp-icon)
  6. <https://addons.mozilla.org/en-US/firefox/addon/nominers/?src=search>
  7. [https://chrome.google.com/webstore/detail/minerblock-%D0%B1%D0%BB%D0%BE%D0%BA%D0%B8%D1%80%D0%BE%D0%B2%D1%89%D0%B8%D0%BA-%D0%BC%D0%B0/jdkbipcangaabpffdcffceneekilajh?utm\\_source=chrome-ntp-icon](https://chrome.google.com/webstore/detail/minerblock-%D0%B1%D0%BB%D0%BE%D0%BA%D0%B8%D1%80%D0%BE%D0%B2%D1%89%D0%B8%D0%BA-%D0%BC%D0%B0/jdkbipcangaabpffdcffceneekilajh?utm_source=chrome-ntp-icon)
  8. <https://addons.mozilla.org/en-US/firefox/addon/themineblock/?src=search>
  9. [https://chrome.google.com/webstore/detail/no-bitcoin-miners/boeoabmkdhmjbbdhocnopfkikcpdff?utm\\_source=chrome-ntp-icon](https://chrome.google.com/webstore/detail/no-bitcoin-miners/boeoabmkdhmjbbdhocnopfkikcpdff?utm_source=chrome-ntp-icon)
  10. [https://chrome.google.com/webstore/detail/no-mining-block-coin-mini/hoafonbifbcbhdconhnmcpnpnplaekb?utm\\_source=chrome-ntp-icon](https://chrome.google.com/webstore/detail/no-mining-block-coin-mini/hoafonbifbcbhdconhnmcpnpnplaekb?utm_source=chrome-ntp-icon)
  11. [https://chrome.google.com/webstore/detail/minerstop/ackjaljejiacdiiipdckacennamgadp?utm\\_source=chrome-ntp-icon](https://chrome.google.com/webstore/detail/minerstop/ackjaljejiacdiiipdckacennamgadp?utm_source=chrome-ntp-icon)
  12. [https://chrome.google.com/webstore/detail/crypto-miner-blocker/fekkecoifalagdiiibmfmmjfmngmpblogb?utm\\_source=chrome-ntp-icon](https://chrome.google.com/webstore/detail/crypto-miner-blocker/fekkecoifalagdiiibmfmmjfmngmpblogb?utm_source=chrome-ntp-icon)
  13. [https://chrome.google.com/webstore/detail/miner-away/fogeciakcpgnbjnacoddpofimlebhnn?utm\\_source=chrome-ntp-icon](https://chrome.google.com/webstore/detail/miner-away/fogeciakcpgnbjnacoddpofimlebhnn?utm_source=chrome-ntp-icon)
  14. [https://chrome.google.com/webstore/detail/coin-hive-blocker/ccagdbjcbhmedcbbknfebhhdobolnimo?utm\\_source=chrome-ntp-icon](https://chrome.google.com/webstore/detail/coin-hive-blocker/ccagdbjcbhmedcbbknfebhhdobolnimo?utm_source=chrome-ntp-icon)

We can still add that the increase in the value of the various cryptocurrencies has in fact happened during the past year and has started to affect many people who have already invested in advanced computer stations aimed at *mining*, of course, there are alternatives to this way of earn and without undermining (among other things for everyone) that take the name of "*faucet*" or faucet sites (portals in which access can be a profit, like the site "*Free Bitcoin*" where there are winnings of about 0.00000226 BTC and where there is a jackpot and a *referral* or further profit by invitation to the game extended to others, see figure 6).

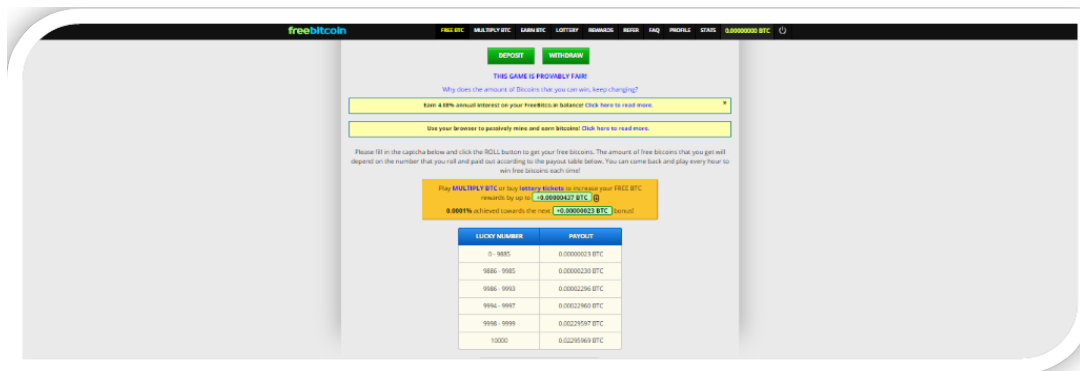

Figure 5. Free Bitcoin site (<https://freebitco.in>)

Among the expenses, the graphics cards are the most requested and installed because more computing power is available and much less time will be needed to get to earn a nice nest egg and enrich the wallet, the historical moment is therefore not negligible to world level, not only, but it is also urgent to point out that the technology created and developed with cryptocurrencies is progressing more and more every day, even in the raw materials sector, that is, the one in which the "old" (including dollar).

The *blockchain* is therefore the new Columbus' egg; it works like a big electronic register that, however, does not present risks of any counterfeiting, besides it cuts the intermediation costs. Here is the future take the first steps: in the field of energy, as in the case of Italy, there have been strong and proven experiences in the exchange of electricity via blockchain (which is a list in constant and continuous growth of records called "*blocks*" connected to each other in safety through precisely the cryptography), with Enerchain, the platform implemented by Ponton that has obtained funding from twenty European utilities and it is not a little!

Also on the Italian peninsula, Alan Silvestri (a Livigno dealer) together with his entire family, has even opened a shop for the sale of sporting goods (accessories) with the possibility of paying with the cryptocurrency currency, guaranteeing the anonymous transfer of coins with a consequent positive balance.

One way to know the prices is the technical analysis at the market level that, naturally, would require specific technical skills and that is why online services like "*TradingView*" (<https://uk.tradingview.com/> or <https://it.tradingview.com/>) were born, which collects expert analysis and provides aid for the sales and purchases.

## Results and Discussion

Even if we are close to utopia it is worth saying that, despite everything, it seems we are about to come forward with a prophecy on the digital currency, in fact, many ask to pay with BitCoin to exchange money and pass the banks, remember that even in United States, exactly in the poor (and devastated by hurricanes) island of Puerto Rico, some men have recently enriched themselves with this coin and have not failed to openly manifest their dream, that is, found a criptocity and not pay any taxes (and this thanks to the decentralization and lack of competent authorities). It is a utopian reality that, however, re-proposes the thought behind the blockchain (to be clear: the decentralized

and distributed peer-to-peer network that allows the recording of data and agreements or contracts).

Perhaps we are not far from hypothetical new tax havens, especially if we take into consideration possible facilitations and capital gains.

The first step was the purchase of real estate for the purpose of building the new city by the founders of *TokenCoin*.

The cryptocolonizers have then confirmed in the New York Times the intention to erect "Puertopia", so it should at least be called the *BitCoin City*.

By now, you can also earn money from the smatphone playing with different Apps and the appearance of short commercials (among these there is "*Blockchain Game*" that makes money during the game by aligning the blocks).

The virtual currency may not replace the classic payments, certainly, will assume ever greater importance in our future: just a year ago a BitCoin, in Europe, had a value of 900 euros and in December 2017 it had even reached 16,000 (even if at this time it fell to less than 10,000), however, to know and convert or calculate a small unit of currency "*Satoshi*" (as the pseudonym of Satoshi Nakamoto the unknown character creator of the cryptocurrency) in BTC I recommend visiting this site: <http://satoshitobitcoin.co/>



Figure 6. Satoshi site

Among the sites to exchange currency visited is "*Bitcoin Charts*"(<https://bitcoincharts.com/>) because it shows the evaluation of Bitcoin on the main and most popular exchange sites, equally interesting is finally "*Bitstamp*"(<https://it.bitstamp.net/>) that allows the exchange ("*Buy / Sell*") with real coins and the opening of an account / a new account by selecting the button for registration (by mail you will then receive the credentials Client ID and Password to log in (a customer documentation will still be required).

Remember that every day you can collect money online with a simple registration to some sites (for example: <https://qoinpro.com/>).

There are several alternatives to BitCoin that are called, as already anticipated at the beginning, "Altercoins" and that work very similar to the first coin, among these "*Litecoin*" can be considered as a relative (almost a small brother) even if lower level but quite active, follows "*Ripple*" because treated by many lenders (just remember Unicredit) for transactions, therefore, "*Monero*" (whose

name in Esperanto indicates the currency), "*Stellar Lumens*" (used for transfers between different currencies) and "*Iota*" (which derives from a Berlin startup).

## **Conclusion**

At the end of the presentation, we ask ourselves: which predictions or prophecies can be satisfied in 2018? Bitcoin certainly does not set limits and in the meantime some already have a slogan: "To the moon"! This reveals the great optimism that can not, however, hide probable and unpredictable fluctuations.

Some say that online transactions are based on the honesty of the same, however, without specifying who or what we are actually talking to or who we refer to, then hope for hypothetical incentives that should be based on maximum profit (for this purpose we remember the theory of games).

Among various factors, we must bear in mind that if we are able to do these things that we have analyzed and on which we have made our reflection, precisely, if the blockchain is a transaction log, how can we accurately determine the criteria valid for everyone? The databases, in fact, are connected to the type of cryptography applied and, consequently, to the true native digital resources but all this will not be feasible.

There is currently a real online trading platform that, which can be accessed as a public or private customer, these are now willing to lose, but you remember that basically it is not real (here there is no fixed value and only a small part it is used for payments) and we can not consider these new coins as a real or a concrete commodity (it is also valid in bonds / shares: no one responds to the value).

We will see in the near future who will therefore assume full responsibility for the new forms of online transaction.

## **References**

- Capoti, D., Colacchi, E., Maggioni, M. (2015). Bitcoin revolution: La moneta digitale alla conquista del mondo. Milano: Hoepli.
- Pepe, S. (2014). Investire Bitcoin. Palermo: Flaccovio, D.
- Birindelli, C., Coco, G. (2018). Addio vecchie monete: ...è l'ora di Bitcoin. Treviglio: Facco, L., Goware.
- Tonelli, S. (2017). Dall'oro al bitcoin. Youcanprint Self-Publishing.
- Caetano, R. (2016). Bitcoin. Milano: Apogeo.
- Pagano, M. (2017). Blockchain. Cyberwar e strumenti di intelligence. Viterbo: Nuovi Equilibri.
- Amato, M., Fantacci, L. (2016). Per un pugno di bitcoin: rischi e opportunità delle monete digitali. Milano: UBE.
- Amato, M., Fantacci, L. (2014). Moneta complementare. Milano: Mondadori, B.
- Florindi, E. (2016). Deep web e bitcoin: Vizi privati e pubbliche virtù della navigazione in rete. Reggio Emilia: Imprimatur.

## **Acknowledgements**

I thank my family for their patience and encouragement.

## *Part 2: Economics*



# Valuation of Public Goods in Agricultural Landscape: The Case of Slovakia

Veronika Nambuge, Artan Qineti, Miroslava Rajcaniova, and Dimuth Nambuge

Faculty of Economics and Management  
Slovak University of Agriculture in Nitra, Slovakia

## Abstract

For decades economists have devoted attention to issues of valuing public goods. However, such studies do not exist in case of Slovak economy. The aim of this paper is to evaluate willingness to pay (WTP) for agricultural landscape in Slovakia by using the Contingent valuation method. The research objectives prioritize how the public values agricultural landscape held by small and large farms. Majority of Slovak farms are identified large in size compared to the EU28. As shown by the results the WTP for landscape offered by large farms is 23.88 Euros per individual per calendar year. These results provide important insights for decision makers, policy makers and social scientists.

**Keywords:** contingent valuation method, willingness to pay

## Introduction

Market failure has enthused many administrations to design support programs which aim to improve the provision of agricultural public goods. Several countries, particularly developed ones, implement policies which support farmers in maintaining rural environment, landscape and other societal benefits. In the EU context, since the 1990s there has been a significant shift in the emphasis of the Common Agricultural Policy (CAP) in this direction. Instead of supporting commodity prices, the policy reforms have been redirected to integrate environmental aspects into the agricultural support programs. Different measures have been introduced (e.g. cross-compliance, agro-environmental schemes; less favored area payments, Natura 2000) in order to give incentives to farmers to reduce farming practices which may have a negative impact on nature and landscape conservation. The recent European Commission communication on the future CAP, "The CAP towards 2020", aims to further strengthen and enhance these environmental objectives of the CAP (European Commission 2010).

Landscape is one of the key public goods produced by agriculture. Farmers, by being involved in the production of traditional commodities, confer benefits on society by maintaining and creating rural landscapes through a combination of activities covering land use decisions, crop composition, and farming practices. Agricultural landscape is a complex good. The European Landscape Convention defines landscape as "an area, as perceived by people, whose character is the result of the action and interaction of natural and/or human factors" (Council of Europe 2000). Agricultural landscape is the visible outcome of the interaction between agriculture, natural resources and the environment, and encompasses amenity, cultural and other societal values. According to the OECD (2000), landscape can be considered as consisting of three key elements (i) landscape structures or appearance: including environmental features (e.g. flora, fauna, habitats and ecosystems), land use types (e.g. crop types and systems cultivation), and man-made objects or cultural features (e.g. hedges, farm buildings); (ii) landscape functions: such as places to live, work, visit, and provide various environmental services; and (iii) landscape values: concerning the costs for farmers of maintaining landscapes and the value society places on agricultural landscape,

such as recreational and cultural values. The value of the landscape is determined by different components, such as: biological diversity (e.g. genetic species and ecosystem diversity, agrobiodiversity); cultural and historical components (e.g. management of the natural landscape, buildings, traditions, handicrafts, stories and music), amenity value of the landscape (aesthetic value); recreation and access (e.g. outdoor recreation, skiing, biking, camping) and scientific and education interests (e.g. from archaeology, history and geography to plant and animal ecology, economy and architecture) (Romstad et al, 2000; Vanslembrouck and van Huylenbroeck 2005).

In last few decades there has been a great deal of research attempting to value (to place a price on) agricultural landscape (e.g. Drake, 1992; Garrod and Willis, 1995; Hanley and Ruffell, 1993; Pruckner, 1995; Campbell, Hutchinson and Scarpa 2005). As landscape is a non-traded good its monetary value cannot be observed and thus is not available from traditional statistical sources. The literature therefore most often applies a stated preference (SP) approach by using survey-based methods to uncover consumers' willingness to pay (WTP) for landscape. The vast majority of these studies find that society positively values agricultural landscape. However, an important shortcoming of these studies is that nearly all studies on landscape valuations are concerned with valuing specific landscape in a particular location and this study focuses on Slovak republic therefore the results are comparable.

## **Objectives and Methodology**

The main objective of the paper is: Appraisalment of economic value of agriculture landscape by willingness to pay (WTP) method in Slovakia. Specifically the aim is to evaluate the landscape held by small and large farms in Slovakia and their value to respondents. How much respondents are willing to pay for agriculture landscape and countryside and which farms have higher preferences: small or large.

The contingent valuation method (CVM) is widely used to measure the value of environmental public goods. The CVM uses surveys questions to elicit people's preferences for public goods by finding out what they would be willing to pay for them. It presents consumers with hypothetical opportunities to buy public goods, thus circumventing the absence of real market for them. The method is thus aimed to eliciting their willingness to pay (WTP). Respondents to CV surveys may also be asked what level of compensation they would be willing to accept for a loss.

During the personal interview conducted face to face, respondents are presented with materials, which consists of three parts:

- A detailed description of the goods being valued and the hypothetical circumstance under which it is made available to the respondent. The researcher construct a model market in considerable detail which is communicated to the respondent in the form of a scenario that is read by the interviewer during the course of the interview. The market is designed to be as plausible as possible. It describes the goods to be valued, the baseline level of provision, the structure under which the good is to be provided, the range of available substitutes, and the method of payment. In order to trace out a demand curve for the good, respondents are usually asked to value several levels of provision.

- Questions which elicit the respondents' willingness to pay for the goods being valued. These questions are designed to facilitate the valuations process without themselves biasing the respondent's WTP amounts.
- Questions about respondents' characteristics (for example, age, income, occupation etc...), their preferences relevant to the goods being valued, and their use of the goods. This information, some of which is usually elicited preceding and some following reading of the scenario, is used in regression equations to estimate a valuation function for the good. Successful estimations using variables which theory identifies as predictive of people's willingness to pay are partial evidence for reliability and validity.

The aim of the questionnaire is to find out value of the agricultural land to the public. Maintenance of agricultural land is carried out mainly by farms (family farms, cooperatives, or large agricultural farms). Slovak agriculture is characterized by large enterprises (cooperatives) to cultivate large areas of farmland. The total agricultural land in Slovakia is around 2 million hectares. Questionnaire consists of 23 questions which are divided into 4 parts. The first question is focused to find out the priority of respondents, to which areas the Government should spend money from the state budget. Interviewees must sort the list of the following areas, health, education, agriculture and rural development, prevention of criminals, environmental protection, art and infrastructure according to their preference that should be the most subsidized by the state. The second part contains 4 questions which refer to opinion on the agriculture and rural development in general. In these questions, respondents must choose one of five options which are as follows: strongly disagree, disagree, strongly agree, agree, and do not know. The following third section evaluates the agricultural land. Section contains 5 questions.

The aim of the questionnaire is to value agricultural land which includes the following elements:

- scenic value of agricultural land
- preservation of agricultural land for future generations

### *Empirical Model*

In this paper, it is shown that it is possible to consistently estimate mean WTP by using ordinary least squares (OLS), which do not need to specify the probability distribution of WTP. The estimation model proposed in this paper does not risk making specification errors. Moreover the linear projection is very simple and easy to handle.

Let  $y = 1$  (resp.  $y = 0$ ) if a respondent says "yes" (resp. "no") to each bid  $t$  and  $S(t) \equiv \Pr(WTP \geq t)$  be a survival function of WTP. We define  $S(0) \equiv 1$ ,  $S(B) \equiv 0$ , and WTP is continuously distributed in  $[0, B]$ . In this setting,  $E(y | t) = \Pr(y = 1 | t) = \Pr(WTP \geq t) = S(t)$  because  $y$  is a Bernoulli random variable. Using this relation, mean WTP can be calculated as

$$E(WTP) = \int_0^B S(t) dt = \int_0^B E(y|t) dt \quad (1)$$

Let's consider the following linear projection (2).

$$\frac{1}{f(t)}y = x'\beta + v, \quad E(v) = 0, \quad E(xv) = 0 \quad (2)$$

where  $\beta$  is the projection parameter vector  $(\beta_0, \beta_1)'$ ,  $v$  is the projection error, and  $f(t)$  is the density of bid  $t$ . Suppose  $t$  is distributed in  $[0, B]$  and  $f(t) \neq 0$  in this area. This assumption is acceptable because the distribution of a bid can be controlled. Because  $E(y | t) = x'\beta f(t) + E(v | t)f(t)$  by (2),  $E(WTP)$  is calculated by (1) as the following (3).

$$E(WTP) = \int_0^B x'\beta f(t)dt + \int_0^B E(v|t)f(t)dt = \int_0^B x'\beta f(t)dt \quad (3)$$

By changing  $\beta$  in (3) to  $\hat{\beta}$  which is a estimator by regressing  $\frac{1}{f(t)}y$  on  $x$ , we can estimate  $E(WTP)$  as the following

$$\hat{E}(WTP) = \int_0^B x'\hat{\beta} f(t)dt \quad (4)$$

Where  $\hat{\beta}$  is a OLS estimator by regression  $\frac{1}{f(t)}y$  on  $x$ ;

$$\beta = (n^{-1} \sum_{i=1}^n x_i x_i')^{-1} \left( n^{-1} \sum_{i=1}^n x_i \frac{y_i}{f(t_i)} \right) \quad (5)$$

Index  $i$  shows a observation  $i$  and  $n$  is the total number of a sample. Because  $\hat{\beta}$  is a consistent estimator of  $\beta$ ,  $\hat{E}(WTP)$  is also a consistent estimator. Generally, we cannot calculate (4) as closed form, so we have to calculate (4) numerically to get  $\hat{E}(WTP)$ .

In this simulations, the non negative dependent variable  $y_i$  is generated so that  $\Pr(y_i = 0)$  is substantial and

$$E(y_i/x_i) = \exp(x_i'\beta) \quad (6)$$

where  $x_i$  is vector of regressors. In particular,  $y_i$  is generated as a finite mixture model of the form

$$y_i = \sum_{j=1}^{m_i} z_{ij} \quad (7)$$

where  $m_i \geq 0$  is the number of components of the mixture, and  $z_{ij}$  is a continuous random variable with support in  $R^+$  and distributed independently of  $m_i$ .

Besides being computationally convenient, this data generation scheme has a natural interpretation in the context of trade data. Indeed,  $m_i$  can be understood as the number of respondents  $z_{ij}$  and the answers by amount of money willing to pay by inhabitant  $j$ .

It is possible to conclude that

$$E\left(\frac{y_i}{x_i}\right) = E\left(\frac{m_i}{x_i}\right)E\left(\frac{z_{ij}}{x_i}\right) \quad (8)$$

Therefore, if  $E(m_i/x_i) = \exp(x_i'\gamma)$  and  $E(z_{ij}/x_i) = \exp(x_i'\delta)$ , we have that  $E(y_i/x_i) = \exp(x_i'\beta)$  with  $\beta = \gamma + \delta$

Draws of  $z_{ij}$  can be obtained from any continuous distribution with support in  $R^+$ , like the gamma, lognormal or exponential distributions. However, due to it's additively, the gamma distribution is particularly suited for simulations and it is used here.

#### Determinants of the Stated Willingness-to-pay

Variables expected to determine the stated willingness-to-pay include: the respondent's income, the frequency of visiting the environmental goods, environmentally and spatially-related preferences expressed by the respondent and the respondent's attitude to environmental goods, respondent's age, gender, education and employment.

**Table 1.** Summary Statistics

Variable	Description	Units	Obs	Mean	Std. Dev.	Min	Max
big_farms	WTP for large farms	Euros	406	1.633	6.317	0.000	50.000
small_farms	WTP for small farms	Euros	406	1.542	6.947	0.000	80.000
Income	monthly income	Euros	406	545.824	364.303	50.000	1950.000
Education	educational level; 5 categories	categories	406	4.121	0.839	1.000	5.000
Family size	Number of family members	individuals	406	3.65	1.36	1.000	7.000
Age	Respondent's age; 6 age cohorts	categories	406	2.872	1.400	1.000	6.000
Employment	Respondent's working status; 1 if working and 0 otherwise	dummy	406	0.700	0.459	0.000	1.000
Place	1 if urban household and 0 otherwise	dummy	406	0.468	0.500	0.000	1.000

The model is specified as follows:

$$WTP = \beta_0 + \beta_1age + \beta_2gender + \beta_3education + \beta_4income + \beta_5employment + \beta_6place + \beta_7familysize + ei \quad (9)$$

The dependent variable shows the questionnaire participants desire to pay money to secure the existing large size farmlands. Non economics variable as mentioned in the equation are discussed. The model specification was based on similar studies in accordance to compare results (e.g. Bergstrom and Ready, 2009). Participants were categorized into six segments. The age categories are 18-29, 30-39, 40-49, 50-5, 60-69 and above 70. The education of the respondents were divided into 5 categories. Namely, without education, elementary education, secondary education, vocational training and university education. The incomes of participants were categorized using their average income levels and further each category of earnings used the center point of their earnings. With respect to their type of employment the participants were firstly put in to two groups. First, group of participants who are employed wither full or part time. Secondly, the participants who are unemployed due to many reasons in nature such as health issues, retirees, studying in fulltime education. Binaries were used with respect to the areas of participants' living.

People who lived in towns and cities were binary 1 whereas people who lived in village rural area as 0.

The questionnaire survey was taken in the cities of Nitra and Topolcany and in surrounding villages. The interviews were taken in two stages and all together were interviewed 406 respondents. In the first stage 202 people answered the questionnaire and in the second stage it was 204 people who answered the questionnaire.

## Findings

In the first part of the interview respondents were asked hypothetical question. They were supposed to assume that agriculture will stop existing and how it can affect certain areas in agricultural landscape.

**Table 2.** Distribution of Respondents According the Answers

	<b>Country would be less attractive</b>	<b>Rural economy suffers</b>	<b>The rural population suffers</b>	<b>Fewer people visit the countryside</b>	<b>Environmental quality will improve</b>	<b>Conditions for wildlife will improve</b>
Strongly disagree	5%	1%	2%	4%	18%	14%
Disagree	18%	7%	9%	26%	43%	27%
Agree	53%	47%	47%	31%	12%	19%
Strongly agree	16%	39%	35%	14%	8%	9%
Do not know	9%	6%	6%	25%	20%	31%

Majority of respondents (53%) agree with the statement that countryside would be less attractive. Another 16% of respondents strongly agree with the above statement. Only 5% of respondents strongly disagree that countryside would be less attractive and 18% disagree with this statement. Another question considers that rural economy would suffer. With this statement again most of the respondents agree 47% and strongly agree 39%. Just 1% of respondents strongly disagree and 7% agree. Even in third part most of the respondents agree 47% that rural population would suffer plus 35% strongly agree. Again low percentage of respondent strongly disagree 2% and disagree 9%. Respondents were not so sure about less visits to the countryside. Even though again most respondents agreed 31% only 14% strongly agree but 26% of respondents disagreed with this possibility and 25% didn't know. In next part first time appeared higher percentage of respondents who disagree 43% and 18% strongly disagree that environmental quality will improve. Lower percentage or people agreed 12% and 8% strongly agreed, plus 20% don't know about environmental part. The last section of this hypothetical question considered that conditions of wildlife will improve. But in this case respondents were bit confused and that is why most of them 31% answered don't know.

Regarding the willingness to pay for the large farms, participants were willing to pay 23.88 euro/per person/per year. Most of the respondents 70% were not willing to pay anything for agriculture landscape. 28% of respondents were willing to pay 12 - 240 euro/per person/per year. The smallest amount of respondents only 2% were willing to pay more than 240 euro/per person/per year.

Willingness to pay for the small farms was 24.60 euro/per person/per year. Most of the respondents 71% were not willing to pay anything for agriculture landscape. 27% of respondents were willing to pay 12 - 240 euro/per person/per year. The smallest amount of respondents only 2% were willing to pay more than 240 euro/per person/per year.

By comparing previous results respondents who were interviewed are willing to pay 0.72 euro/per person/per year more for the small farms than for large farms. After gathering data and summarizing the results of the questionnaire we conducted a regression analyses of the willingness to pay for large and small farms. The results are provided in the tables 3 and 4, respectively. Table 3 illustrates the regression results with robust standard errors for the estimated willingness to pay for large farms of all respondents.

**Table 3.** Regression Results for Large Farms

Variable	OLS		Poisson		Negative bin. Reg.	
	Coef.	Std. Err.	Coef.	Std. Err.	Coef.	Std. Err.
ln_income	0.18**	0.09	0.48**	0.23	0.47**	0.22
Education	-0.02	0.04	-0.08	0.13	-0.07	0.13
Familysize	-0.01	0.03	-0.03	0.08	-0.03	0.08
Age	-0.12***	0.04	-0.36***	0.10	-0.35***	0.10
Employment	-0.10	0.12	-0.12	0.31	-0.15	0.34
Place	0.11	0.08	0.32	0.23	0.33	0.22
_cons	-0.25	0.52	-2.74*	1.57	-2.67**	1.30
/lnalpha	-	-	-	-	0.49	0.25
Alpha	-	-	-	-	1.64	0.41
R-squared (Pseudo)	0.057	-	0.062	-	-	-

Note: \* $P(<0,1)$ ; \*\* $P(<0,05)$ ; \*\*\* $P(<0,01)$ .

All of the variables have small effect. Model is statistically significant (p-value  $<0.05$ ). The variable income is statistically significant at alpha 0.05. This means that for each one-unit increase in income, the expected log count of the amount of money the person is willing to pay for the current agricultural landscape increases by 0,47. The variable age is statistically significant at alpha 0.01. This means that for each one-unit increase in income, the expected log count of the amount of money the person is willing to pay for the current agricultural landscape decreases by 0.35.

Table 4 illustrates the regression results with robust standard errors for the estimated willingness to pay for small farms of all respondents.

**Table 4.** Regression Results for Small Farms

Variable	OLS		Poisson		Negative bin. Reg.	
	Coef.	Std. Err.	Coef.	Std. Err.	Coef.	Std. Err.
ln_income	0.04	0.08	0.08	0.22	0.07	0.20
Education	0.04	0.04	0.14	0.15	0.16	0.14
Familysize	-0.04	0.03	-0.11	0.09	-0.09	0.08
Age	-0.11***	0.03	-0.35***	0.09	-0.36***	0.09
Employment	-0.02	0.10	0.09	0.30	0.15	0.32
Place	-0.06	0.08	-0.19	0.24	-0.21	0.23
_cons	0.45	0.51	-0.85	1.36	-0.94	1.12
/lnalpha	-	-	-	-	0.54	0.23
Alpha	-	-	-	-	1.72	0.39
R-squared (Pseudo)	0.05	-	0.16	-	-	-

Note: \* $P(<0.1)$ ; \*\* $P(<0.05)$ ; \*\*\* $P(<0.01)$ .

Again all of the variables have small effect. Model is statistically significant (p-value <0.05). The variable age is statistically significant at alpha 0.01. This means that for each one-unit increase in income, the expected log count of the amount of money the person is willing to pay for the current agricultural landscape decreases by 0.36.

## **Conclusions**

The research assumes and tries to prove that individuals living in towns and cities are more prone to pay for landscape. The research anticipates that participants residing in towns and cities will express their willingness to pay for cultivation land nevertheless they are large or small in size.

After running a regression the research concludes that where participants place of home is also a factor that influence their likeness to pay for landscape. Further, the town and city citizens are extremely willing to pay for farmlands which are with high hectares. The earnings of the participants and their attained schooling level makes a considerable correlation for their willingness to pay. The research anticipates the participant who carries a higher level of knowledge due to his/her education will be highly willing to pay as opposed to those individuals who have gained basic or no education. The same consequences expected with individuals with higher earnings and lower earnings.

After looking at various geographic regions in Slovakia it is eminent that Nitra is more established region in terms of cultivation. The protection of land in this area is often attached to cultural and ecological aspects. The research data analysis concludes the most prominent factor for WTP is the earnings of the individual participants. Even though Slovakia is not a poor country due to low levels of earnings by people living in rural areas they are very careful of spending. This is due to the fact of tight disposable income levels. Some other researches however said earnings are not correlated to WTP. In addition higher knowledge individual appreciate the view than people with no or little education. The research anticipates these two factors have some interconnectedness. Which means people who had university or other high knowledge accumulation are likely to have higher earnings.

From the analysis of this paper it is eminent that there are no significant changes in socio-demographic items of the respondents. Age of the participants were around the age of 50 and been woman. Mainly the participants were from village areas.

Even though there are several different opinions on the planed tax rate increase in according to increase the quality of agriculture, the research could estimate the normal willingness to pay for landscape. As mentioned in the research majority of the farm size been large and the WTP for those large lands are 23.88 Euros per individual per calendar year. However, over 2/3 of the participants said they are unwilling to pay for agricultural landscape. 28% almost all the rest mentioned willingness to pay between 12-240 Euros annually. The 2% of the participants were delighted and willing to pay over 240 Euros per year. There are several prominent factors affected the WTP of individuals. The most prominent factor been age. Young participants were willing to pay more than the elderly. Further, respondents with higher earnings had the motivation and willingness to secure landscape and was willing to pay more. Additionally people living in cities and town who were missing the relax atmosphere were much more WTP.



To conclude the results and observations it is imminent citizens of Slovakia do not concern the value of public goods and preservation of agricultural landscape.

## References

- Bergstrom, J. C., and Ready, R. C. (2009). What Have We Learned from Over 20 Years of Farmland Amenity Valuation Research in North America? *Review of Agricultural Economics*—Volume 31, Number 1—Pages 21–49
- Campbell, D. & Hutchinson, W. Riccardo, S. (2008). Incorporating Discontinuous Preferences into the Analysis of Discrete Choice Experiments. *Environmental & Resource Economics*.
- Drake, L. (1992). The non-market value of the Swedish agricultural landscape, *European Review of Agricultural Economics*, vol. 19 pp. 351-364.
- EC (2016). Cross compliance, Agriculture and Rural development, [Online], Available at: [https://ec.europa.eu/agriculture/direct-support/cross-compliance\\_en](https://ec.europa.eu/agriculture/direct-support/cross-compliance_en)
- Garrod, G.D. and Willis, K.G, Methodological issues in valuing the benefits of environmentally sensitive areas, *Journal of Rural Studies*, 15, 1, (111), (1999).
- Hanley, N., Colombo, S., Mason, P. and Johns, H. (2007). The reform of support mechanisms for upland farming: paying for public goods in the Severely Disadvantaged Areas of England, *Journal of Agricultural Economics*, vol. 21 pp. 433-453.
- Hanley, N., Wright, R.E. and Adamowicz, V. (1998). Using choice experiments to value the environment, *Environmental and Resource Economics*, vol. 11 no.3-4 pp. 413-428.
- Hodge, I. (2008). To what extent are environmental externalities a joint product of agriculture? Overview and policy implications, in: *Multifunctionality in agriculture: evaluating the degree of jointness, policy implications*, OECD Publications: Paris
- Huylenbroeck, V. G., Vandermeulen, V., Mettepenningen, E., Verspecht, A. (2007). *Multifunctionality of Agriculture: A Review of Definitions, Evidence and Instruments*.
- JRC (2009). Final report on the project ‘sustainable agriculture and soil conservation (SoCo)’, European Commission Joint Research Centre: Brussels.
- IPCC (2002) Climate change and biodiversity: Technical Paper V, Intergovernmental Panel on Climate Change, [Online], Available at: <http://www.ipcc.ch/pdf/technical-papers/climate-changes-biodiversity-en.pdf>
- Mitchell R.C. and Carson R.T. (1989). *Using Surveys to Value Public Goods: The Contingent Valuation Method, Resources for the Future*, Washington D.C., 1989, ISBN: 0-915 707-32-3
- OECD and FAO (2009). *Agricultural Outlook 2009-2018*, [Online], Available at: <http://www.agri-outlook.org/dataoecd/2/31/43040036.pdf>
- Pruckner, G.J. (1995). Agricultural Landscape Cultivation in Austria. An application of the CVM. *European Review of Agricultural Economics* 22(2):173-90.
- Romstad E., Vatn A., Rorstad PK., Soyland V., (2000). *Multifunctional Agriculture: Implications for Policy Design*. Ås: Agricultural University of Norway. Report no. 21
- Vanslebrouck, I. and Huylenbroeck, V. G. (2005). *Landscape amenities*. Publisher Springer Netherlands, 1. Edition, 202 p. ISBN: 9781402031342.

## Acknowledgements

This work was supported by the Slovak Research and Development Agency under the contract No. APVV-15-0552 and VEGA 1/0797/16.

## ***Part 3: Education & Training***

# **Developing Global Leaders: A Study of MBA Programs in the Caribbean and Central America**

Paul Pounder and Rachael Ross

School of Arts and Sciences  
St. George's University, Grenada

## **Abstract**

MBA programs are key to developing effective global leaders. After carefully examining and defining global leader and global leadership, this study explores the characteristics of MBA programs in the Caribbean and Central America. It focuses on assessing programs based on availability, program quality, program length, entry requirements, cost, target markets and courses in the curriculum. The aim is to determine how effective the MBA programs are at preparing participants for leading change and making a positive impact on international businesses. The methodology examines 34 MBA programs in the Caribbean and Central America. An analysis was conducted to determine the similarities and differences in characteristics of each program. The findings highlight that a Master of Business Administration (MBA) comes in many forms and fashions. The MBA degrees show specific teaching and learning in core areas like accounting and finance, marketing and market research, leadership and human resources management, and operation and logistics management; with specializations and concentrations designed to meet unique fields of study. The conclusion highlights similarities in entry requirements across the board, with some organizations providing full-time and/or part-time options of study. It was recognized that the courses offered in the respective 34 programs do not differ significantly in course loads and course descriptions. However, more needs to be done to ensure that leadership education is more prevalent in the MBA programs in the Caribbean and Central America. The authors proposed two approaches to integrating leadership into MBA programs; the Workshop Model and the Achieving Styles Inventory.

**Keywords:** education, Americas, leadership, integration, ranking, model

## **Introduction**

In their article *What is Global Leadership?* the authors posited that although there has been a clarion call for global leaders to address challenges faced by many international organisations, and despite several scientific contributions made to understanding the term 'global', 'global leader' and more so the scope of 'global leadership', there is still no common conception of the three terms. This therefore suggests that there may be a risk of knowledge development in that area (Reiche, Mendenhall, Bird, & Osland, 2013).

Leading others globally is a complex task, requiring one to possess certain qualities and skills such as flexibility, cultural awareness, among others. In addition to the complexity of the job, a global leader also needs to develop the mindset and skill set required to succeed in this complex environment, be effective in leading people across cultures, time zones, distances and complex organizational structures like matrix and have the understanding that they play a role in transforming not only their companies, but also the societies in which they operate. Moreover, in their definition of 'global leader', Reiche, Mendenhall, Bird, & Osland (2013) highlighted that

“research shows that global leaders share three common characteristics: they have a global mindset which allows them to connect across boundaries, they are global entrepreneurs driven to create new solutions and seize opportunities, and they are global citizens inspired to contribute to the communities they touch.” With this, our definition of global leadership is leading others (teams or individuals) who are based in international and multicultural contexts, engaging with many groups of diverse stakeholders and individuals, to complete tasks and to meet goals (Financial Times, n.d.). The question now becomes how does one acquire the requisite skills of a global leader?

## **Literature Review**

### *MBA Education*

The MBA degree originated in the United States in the early 20th century. Some of the drivers to the MBA programs include: demographic changes, information technology communication, globalization, new venture creation opportunities, and competition among management education (Thomas, 2007). The MBA programs usually comprise of core courses and elective courses/concentrations for further specialization. Graduate business course work addresses issues through: theoretical, analytical, and practical discourse (Kachra & Schnietz, 2008). Key to the development and selection of MBA programs are based on the program relevance to students, businesses and society (Muff, 2012). This was further supported by Temtime & Mmerekki (2011) who posited that MBA students were interested in programs that offer management skills and career development opportunities. While Contreras & Ruff (2002) investigated whether the demand for MBA graduates in a Latin American environment was being satisfied by existing MBA programs. Whereas, Ma & Trigo (2011) highlighted that the significance of MBA education is linked to producing participants that can operate in a multi-cultural context. Which was further developed by Thomas, Martin, & Riggio (2013) when they highlighted strategic leadership as a need for participants of MBA programs, who are more and more being required to operate in a globalized environment.

### *Higher Education and MBA Programs*

Higher education is a key sector in any nation, as it contributes to the success, prosperity and economic development of that country by nurturing professionals on all levels; i.e. it is associated with the quality of its human resource and their intellectual capabilities. One essential element of higher education is that of the popular Master of Business administration (MBA). This degree program functions as a postgraduate qualification in business management and is internationally recognized, especially in the UK, US, Australia, and Asia. Furthermore, acquiring an MBA in many quarters is seen as a ticket to senior managerial positions and the possibility of promotion opportunities and earning higher salaries than their counterparts (Gander, 2015). Research conducted on the impact of MBA programme attributes on post-MBA salaries, support that persons enroll in an MBA program with the hope of earning a higher salary. Their findings demonstrated that higher post-MBA salaries are associated with pre-MBA salaries (Elliot & Soo, 2016).

In its general sense, higher education entails training from a post-secondary institution, to prepare individuals for employability. Employers seek persons with certain professional skills like critical

and analytical thinking skills, decision-making skills, communication skills, teamworking skills, ethical judgment, etc. However, research on higher education and professional graduates' employability status in India, found that in many cases, when corporate personnel visit colleges for campus placements, "the students of professional courses do not meet the requisite skills desirable for the professional world, thus making them unemployable in several sectors of the corporate industry"; i.e. they lack employability skills (Dhingra, 2017). Further, Wellins & Sinar (2016) conducted a study of how MBA programs make great leaders and where they fail, by assessing 15,000 leaders across 300 companies in 15 countries, both undergraduate and MBA, on different leadership skills: financial acumen, business savvy, compelling communications, driving execution, driving for results, entrepreneurship, influence, and inspiring excellence. Their findings indicated that although both groups did well on several leadership skills, the MBA graduates consistently outperformed undergrads in classical business skills: financial acumen (+12%), business savvy (+6%), and strategic decision making (+6%). However, they fell short on interpersonal and inspirational skills including: coaching (-3%), results orientation (-6%) and visionary leadership skills (-7%).

Additionally, most employers consider the average graduate to be deficient in many professional skills previously mentioned. With a focus on more core business activities, many employers forgo training their employees, with the expectation that the higher education institutions would produce "oven ready" graduates to be adequately placed in corporate workplaces (Dhingra, 2017).

In considering the value of the MBA to employers, Gander (2015) notes that the MBA aids in recruitment, in that "... they provide a framework to vet applicants easily and quickly and provide a guarantee of standards in the level and scope of education." Additionally, they provide firms/business with human capital like knowledge, skills and capabilities that are to be used for corporate gain.

Therefore, given the function of higher education, institutions of the like can contribute to bridging the skills gap to producing quality, highly skilled/trained professionals who would enter the labour market and in addition to improving the company's turnover rate, would also contribute to the country's overall success and prosperity.

### *The Status of MBA Programs*

With the significant increase in the number of MBA academic programs, much debate has erupted over the quality of these programs. The literature has highlighted a barrage of criticism and questions regarding the academic quality of such programs which has come about due to the influx of new MBA programs. This study compares various MBA programs in the Caribbean and Central America; and discusses the level of effectiveness of these programs in preparing Caribbean and Central American students for leading change and making a positive impact in the international business arena. While past experiences in leadership roles is essential for business executives, directly teaching leadership has often been overlooked in MBA education (Datar, Garvin, & Cullen, 2010).

A general overview of MBA programs highlights that they are being offered through various options: full-time MBA, part-time MBA, executive MBA, and online MBA modes; with varying entry levels such as cost, qualifications, and other parameters to gain entry into the program

(Heslop & Nadeau, 2010). The recognized core curriculum in the MBA programs is a set of common courses required by all graduates and considered the necessary general education for students. These core curriculum courses expose students to various areas of business such as accounting and finance, marketing and market research, leadership and human resources management, and operation and logistics management. With concentrations and tracks allowing for more focused studies in specialized areas, indicating a shift from traditional MBA programs to specialized programs (Goldgehn & Kane, 1997; Johnson, Thomas, & Peck, 2010). However, Bennis & O'Toole (2005) posits on the failure of business schools to produce graduates with competencies that allow for successful functionality in a global business environment. A case was also made for the enhancement of MBA curriculum with multi-disciplinary content which is more in-keeping with the needs of graduates (Bennis & O'Toole, 2005).

This consideration of the state of higher education as it relates to MBA programs is since limited research exists in this field for Caribbean and Central American nations. The expectation is that such research can inform the educational sector's policymaking and practice. The dynamics across these realms has also been informed to some extent by identification of the challenges and opportunities facing MBA graduates worldwide.

#### *MBA Education in Caribbean and Central America*

The Caribbean and Central American Region is commonly recognized as an area of islands and mainland countries touching the Caribbean Sea. The Caribbean is the region roughly south of the United States, east of Mexico and north of Central and South America, consisting of the Caribbean Sea and its islands. While Central America is the southernmost part of North America on the Isthmus of Panama, that links the continent to South America and consists of the countries south of Mexico: Belize, Guatemala, El Salvador, Honduras, Nicaragua, Costa Rica, and Panama (Blouet & Blouet, 1997). They share a common geographical and climatic area as well as a complex cultural background. The region is considered part of the developing world and as such has formed the basis of this study, to explore the MBA programs in the Region that are geared towards developing global leaders that can successfully take the Region and its businesses into the next century. This study is important as many parts of this Region still suffer from educational exclusion, with many youths having high risk of dropping out at all levels of educational attainment, thus creating a very small pool for leaders to emerge.

However, there are still many reasons why students choose to pursue MBAs in the Region. Dailey, et al. (2006) in their study set out to determine the reasons why students pursue an MBA, and recognized themes such as "need for knowledge," "general business knowledge," "valuable business credential". While Carrel & Schoenbachler (2001) in their examination of students considering an EMBA based decisions on considerations as personal, academic, and financial.

A further trend observed in MBA education in the Caribbean and Central America is that of tertiary institutions and other smaller training institutions offering MBAs and other graduate degrees based on a contractual relationship with foreign universities and institutions. These franchise like or licensing arrangements have grown in popularity and are seen to offer greater flexibility (online options), lower costs (reduced overheads), a wider Faculty arrangement (more specialist teaching), lot more resources (greater journal access) and time advantages (allow for part-time work) to students of business.

## *MBA Program Ranking*

Much has been discussed in the literature about MBA Program rankings; with many institutions praising and criticizing methods. However, it is recognized that typical criteria used to cross reference similarities and differences among programs is based on factors linked to the quality of business school, the diversification of the faculty, and the relevance of the course offerings. It is observed that many of the methods for generating information for the rankings differ: the U.S News and World Report (NWR), Best Colleges Ranking criteria and weights ranking collected information from Deans, Program Directors and Senior Faculty (Best Colleges Ranking Criteria and Weights, 2017); the Business Week ranking conducts surveys of students and recruiters (Nasiripour, 2017); The Financial Times survey Alumni and take into consideration information from the business school (Business Education, 2017); and the Economist surveys business schools, students and recent graduates (Which MBA?, 2018). The criteria and factor weights for ranking was also observed to vary significantly across rankings: the U.S NWR used a weighted formula with graduation and retention rates (22.5%), academic reputation (22.5%), faculty resources (20%), student selectivity (12.5%), financial resources (10%), and graduation rate performance (7.5%), (Best Colleges Ranking Criteria and Weights, 2017); the Bloomberg Business Week used a weighted formula with employer survey rank (35%), alumni survey rank (30%), student survey rank (15%), salary rank (10%), and job placement rank (10%), (Nasiripour, 2017); The Financial Times considered information on salary and employment statistic (Business Education, 2017) and the Economist focused on, open new career opportunities (35%), personal development/educational experiences (35%), increase in salary (20%), potential to network (10%) (Which MBA?, 2018). While this list of Program rankings is not exhaustive, it represents some of the key rankings considered by schools and students alike. It should also be noted that other criteria that should be considered for ranking should include exposure to students of relevant materials, relevant faculty research, number of spin-offs and research funds awarded. Thus, the focus on how well the programs prepare graduates for job success is of paramount importance.

## **Methodology**

For this study, the authors examine the MBA programs in the Caribbean and Central America. As many of these MBA programs are not ranked, other criteria for selection was used. Criteria for Business schools, Centers or Institutes was based primarily on the organization being focused on higher education teaching, research, policy analysis, or related activities. Other criteria included being recognized as a credible organization with full time faculty and an assigned budget. The organizations identified were cross referenced with information provided by Keystone Academic Solutions (2018), which is a reputable organization with 13 years of experience in international student recruitment. In parallel with this approach to scanning the landscape for higher education organizations offering MBAs, the author considered expert opinions of other educators and publication listings in the selection of programs around the Caribbean and Central America to include as many relevant higher education organizations, in as many languages as possible.

## *Sample*

An assessment was done to filter the most popular programs in the Region and their respective features. The sample was made up of 34 MBA programs: 18 MBA programs part-time and 16 EMBA programs as shown in Table 1.

**Table 1: MBA Programs in Caribbean and Central America**

<b>Program Name</b>	<b>University Name</b>
<b>MBA (18)</b>	
MBA International Business	UNIVERSIDAD METROPOLITANA (UMET)
MBA Management	UNIVERSIDAD METROPOLITANA (UMET)
MBA Finance	UNIVERSIDAD METROPOLITANA (UMET)
UCC MBA	UNIVERSITY OF THE COMMONWEALTH CARIBBEAN
MBA	INTER AMERICAN UNIVERSITY OF PUERTO RICO
MBA with Specialization in Marketing and Sales	UNIVERSIDAD ANA G. MÉNDEZ
MBA	KEISER UNIVERSITY LATIN AMERICAN CAMPUS
IMBA	LA UNIVERSIDAD LATINA DE COSTA RICA
MBA	LA UNIVERSIDAD LATINA DE COSTA RICA
MBA	UNIVERSITY OF THE VIRGIN ISLANDS
MBA - Master in Administration	IESA - INSTITUTO DE ESTUDIOS SUPERIORES DE ADMINISTRACIÓN
MBA	UNIVERSITY OF PUERTO RICO RIO PIEDRAS
MBA	THE UNIVERSITY OF THE WEST INDIES - MONA SCHOOL OF BUSINESS & MANAGEMENT
MBA	THE UNIVERSITY OF THE WEST INDIES - CAVEHILL SCHOOL OF BUSINESS & MANAGEMENT
IMBA	THE UNIVERSITY OF THE WEST INDIES - CAVEHILL SCHOOL OF BUSINESS & MANAGEMENT
IMBA	THE UNIVERSITY OF THE WEST INDIES - ARTHUR LOK JACK SCHOOL OF BUSINESS & MANAGEMENT
Global MBA	IESA - INSTITUTO DE ESTUDIOS SUPERIORES DE ADMINISTRACIÓN
MBA	ST. GEORGES UNIVERSITY
<b>EMBA (16)</b>	
European Executive Officer MBA	ADEN CAMPUS GUATEMALA
Flexible Executive MBA	ADEN CAMPUS REPUBLICA DOMINCANA
European Executive Officer MBA	ADEN CAMPUS REPUBLICA DOMINCANA
European Executive Officer MBA	ADEN CAMPUS PANAMÁ
European Executive Officer MBA	ADEN CAMPUS SALVADOR
Executive Master of Business Administration Degree-Jamaica	UNIVERSITY OF NEW ORLEANS COLLEGE OF BUSINESS ADMINISTRATION
Flexible Executive MBA	ADEN COSTA RICA
Master in Management For Executives	IESA - INSTITUTO DE ESTUDIOS SUPERIORES DE ADMINISTRACIÓN
European Executive Officer MBA	ADEN COSTA RICA
Flexible Executive MBA	ADEN CAMPUS PANAMÁ
Commonwealth EMBA	UNIVERSITY COLLEGE OF THE CARIBBEAN
Flexible Executive MBA	ADEN CAMPUS GUATEMALA
Flexible Executive MBA	ADEN CAMPUS SALVADOR
EMBA	THE UNIVERSITY OF THE WEST INDIES - CAVEHILL SCHOOL OF BUSINESS & MANAGEMENT
EMBA	THE UNIVERSITY OF THE WEST INDIES - MONA SCHOOL OF BUSINESS & MANAGEMENT
EMBA	THE UNIVERSITY OF THE WEST INDIES - ARTHUR LOK JACK SCHOOL OF BUSINESS & MANAGEMENT

Further, an analysis was conducted to determine the similarities and differences in characteristics of each program. Finally, the study discusses the level of usefulness of these programs in preparing Caribbean and Central American students for leading change and making a positive impact in the international business arena.



## Findings

The study shows that a Master of Business Administration (MBA) comes in many forms and fashions. It is a graduate degree attained at the tertiary level that provides theoretical and practical training to prepare graduates with a better understanding of the general business management functions. A review of the programs show that the organizations provide full-time and part-time options of study: 12 full-time only, 12 full-time and part-time, and 10 part-time only.

The entry requirements in the 18 MBA programs observed highlighted the majority (61%) need a Bachelor's degree with GPA in good standing (above 2.5) or the equivalent of at least 3-5 years' work experience to enter as a matured student with related experience; while the entry requirements of the 16 EMBA programs observed highlighted having a degree and being a professional with a minimum of 3 – 7 years' experience in senior positions was required by the majority (75%) of the organizations. While only one of the 34 programs stipulated the need for GMAT or GRE scores. GRE is a recognized admissions test for most typical graduate programs both MBA and non-MBA; while GMAT scores are viewed as a commitment to pursuing an MBA.

The MBA degrees show specific teaching and learning in accounting and finance, marketing and market research, leadership and human resources management, and operation and logistics management. Based on the sample of 34 programs observed, the research findings of the MBA Program give credence based on the syllabi to the development of Caribbean and Central American leaders; with 26 (76%) programs offering courses in leadership. Within these classes, students learn how to challenge perceptions about being a leader & values that shape them while thinking differently; basically, preparing them for the international arena. Further, students are more prepared and in-depth with problem-solving skills and social judgment skills.

It was recognized that the courses offered in the respective 34 programs do not differ significantly in course loads and course descriptions. Most (94%) of the 34 programs had a standard strategic focus geared towards empowering participants, while providing quality education, research and leadership. While one of the main peculiarities of the MBA programs was linked to number of supporting workshops to be covered and the number of non-credit courses, which are deemed necessary to support the development of practical and academic skills crucial for MBA graduates. It was observed that 34% of the programs offered three or more specializations or concentrations. While on average, the programs required completion of 42-45 credits.

### *Approaches to Integrating Leadership in MBA Programs*

The findings show that as higher education institutions in the Caribbean and Central America strive to educate students to meet the needs of an increasingly complex world, there is great importance in finding suitable frameworks to enhance preparation of global leader ready graduates. This section highlights two possible models for integrating leadership into MBA programs. In light of the findings, this study which explores leadership development and how institutions of higher education can enhance their leadership capacities of students continues to be a challenge; thus two possible models for integrating leadership into MBA programs are highlighted below.

### *The Workshop Model*

Leadership is a very essential element of any MBA program; however, providing the training in an effective way has proven to be challenging for many higher education institutions. Based on extensive research of business education and interviews with deans of business schools, executives and MBA students, Datar, Garvin, & Cullen, (2010) argue that in order for business education to remain relevant, they should consider emphasising the development of leadership skills and utilize new pedagogies, including experiential learning. They proposed a peer-led team learning coined the Workshop Model.

The Workshop Model was first implemented at the Simon School of Business at the University of Rochester in 2009 for two core courses in their full-time MBA program. The Model as explained by Dobson, Frye, & Mantena, (2013) has different elements including the weekly leader-training seminars, the workshops and the feedback sessions. The main objectives are to help the leaders develop leadership skills, enhance their critical, analytical and conceptual thinking and problem-solving skills.

The leader-training seminar allows for an interactive and collaborative session whereby students meet in small groups to solve challenging problems related to the course content. The students are led by a specially trained peer leader; and are encouraged to apply theory learned in the classroom into real world problems. Moreover, it provides leaders with an opportunity to learn a new skill, practice that skill, reflect individually on the implementation of that skill via a journal, and finally to discuss their success or difficulty with implementing that skill with the other leaders in the weekly seminar.

A mechanism for giving and receiving feedback is included in the Model so that the leaders can obtain comments on what worked well and how they need to improve their leadership behaviours. Subsequently, the leaders meet weekly with other fellow leaders to discuss course workshop problems. After being fully trained during the weekly seminars, the leaders are now competent in leading their groups in the workshop sessions.

Given that the Workshop Model is an effective, research supported learning and teaching practice (Gosser, et al., 2001; Roth, Goldstein, & Marcus, 2001); higher education institutions should consider implementing similar pedagogy in MBA programs, not only as an approach to integrating leadership into the program but also for student engagement and learning, in particular to improve students' problem solving skills involving modeling business situations that differ from the standard, introductory ones they normally experience in the lectures (Dobson, Frye, & Mantena, 2013).

### *The Achieving Styles Inventory (ASI)*

Another approach to integrating leadership into MBA programs is by helping students to understand themselves and their own drives and motivations. Understanding yourself can aid in addressing individual situations as expected of a leader, and to lead people in a healthy and sustainable way (The Washinton Post, n.d.). Through the Connective Leadership Institute, the Achieving Styles Inventory (ASI) is a tool that is used to meet this objective.

The ASI measures nine (9) leadership achieving styles or behavioural strategies that individuals characteristically employ to achieve their goals (Lipman-Blumen, 1998 and 2000). The way how the model is constructed makes it all-encompassing to apply to students in a higher education program. The ASI has three primary leadership sets. With each set having three sub-sets of achieving leadership styles. The primary leadership sets are: direct leadership styles, employed by participants who want to master their own tasks when presented with a challenge; instrumental leadership styles, employed by people who reach out and include others when presented with a task or challenge; and relational leadership styles, employed by those who prefer to work through or with others on tasks and challenges (Lipman-Blumen, 1996). The rationale behind using the model is to elevate the role and performance of the students through the development of a pervasive and wide-ranging leadership capability. The strength of the model is based on the fact that it is built on the identification and measurement of characteristics or behaviors found effective in leading followers through complex situations (Lipman-Blumen et al., 1983; Connective Leadership Institute, n.d.).

Previous studies have been conducted showing the pervasiveness of multiple leadership styles in leaders in varying teaching environments. Some of these studies include student organizations (Posner & Brodsky, 1994); first year undergraduates (Mendez-Grant, 2001), hospitality management students (Arendt, 2004), and leadership development on retention rates (Mendez-Grant, 2001). These studies all point to the prevalence of multiple achieving styles in leaders in specific roles. They also showed that those leaders most likely to meet the complex challenges of the future, need to employ the broadest and most flexible leadership styles.

Further, the research has shown that ASI has many benefits to leaders including determining their own leadership profiles and the leadership expectations and reward structure of their organization, their view of themselves and other people's perceptions of them, their own leadership profile and those of their colleagues, the leadership demands of any given task, project, or situation and the leadership capabilities that they and others bring to the table (Connective Leadership Institute, n.d.).

The connective leadership institute further highlights that the results for the individual inventory (ASI) are presented as a polar graph with narrative feedback that describes an individual's connective leadership profile. The feedback details the behavioral styles that the individual calls upon most frequently, as well as those that the individual uses less often. The narrative describes the strengths and drawbacks of the frequently used styles, as well as the benefits the individual foregoes by failing to use the remaining styles (Connective Leadership Institute, n.d.).

## **Conclusions**

Not all the business schools offer both full-time and part-time options. Some of the institutions only feature full-time coursework, while others specialize in part-time programs. With 22 of the organizations offering a part-time MBA Program, shows that Universities have considered the adult learner who is employed. This part-time option allows students to have a lighter weekly workload by taking only one or two classes. This is beneficial to help students balance full-time work, family and school commitments. Whereas, full-time programs expect students to treat their studies as the focus in their lives.

There is seen to be a diversity of entry requirements, which are basically the results of prior academic or work performance which likely impacts on the acceptance into MBA programs, as such performance is believed to be linked to future academic performance. The findings revealed that most MBA institutions tend to admit students based on completion of an under-graduate degree, transcript evaluation, recommendation letter, personal interview or reflection paper, and aptitude or achievement test scores. Further flexibility in entry requirements included years of work experience and consideration for other professional designations equivalent to under-graduate degrees.

Core courses in the MBA programs are those that are the most fundamental for a well-rounded management education and are often the backbone to the program. In this study, we consider the core courses selected to be accounting and finance, marketing and market research, leadership and human resources management, and operation and logistics management; which is supported by (Temtime & Mmerekki, 2011) as these courses satisfy the basic needs of MBA students looking to be global leaders. Course loads and credits vary slightly between MBA programs. The minimum credit hours for graduate students varies, depending on the semester and the context of the Program.

The findings from the study show that there is more to be done to ensure that leadership education is more prevalent in the MBA programs in the Caribbean and Central American. Programs offer leadership skills and theories to support, however, there is a need for programs to be better equipped with strategic insights, and a deeper understanding of global business context needed to drive growth and profitability in international business operations.

Some recommendations include future work to be done in examining the broader role of leadership education in MBA programs. Further, the factors they need to consider are curriculum design, cost of program, duration of the program, and location of the university and the reputation of the university.

Some limitations to the study have been observed by the authors. It must be acknowledged that mapping the MBA programs in the Caribbean and Central America is not a simple task. There are many ways in which this research could have been organized. The information used may not have captured every criterion that deserves to be recognized, for example, many Universities ask that students make request for sensitive information like Program costs. The authors are also sensitive to the fact that leadership was only highlighted through courses that had “leadership” in their title; however, it is recognized that other courses may speak to various aspects of leadership and may have been missed as the course syllabi were not catalogued.

Another limitation to the study is linked to the fact that the research was conducted using only secondary information to satisfy the aim of the study. However, future research could consider obtaining information from participants regarding a) How has the MBA Program helped you professionally, b) What leadership roles/capacities have you worked in since graduating, c) What is your current profession and location. In turn, analysis of the responses can help deduce whether the participants have/are in fact leading change and making a positive impact globally.

## References

- Arendt, S. (2004). Leadership behaviors in undergraduate hospitality management and dietetics students. Unpublished doctoral dissertation, Iowa State University.
- Bennis, W., & O'Toole, J. (2005). How business schools lost their way? *Harvard Business Review*, 83(5), 96-105.
- Best Colleges Ranking Criteria and Weights. (2017). Retrieved from <https://www.usnews.com/education/best-colleges/articles/ranking-criteria-and-weights>
- Blouet, B., & Blouet, O. (1997). Population: Growth, distribution and migration (3rd ed.). (B. W. Blouet, & O. M. Blouet, Eds.) New York, NY, USA: Wiley.
- Burbank, G. (2018, April 19). Assessment of Achieving Styles Inventory. (R. Ross, Interviewer)
- Business Education. (2017). Retrieved from Business Education: <http://rankings.ft.com/businessschoolrankings/global-mba-ranking-2018>
- Carrel, A. E., & Schoenbachler, D. D. (2001). Marketing executive MBA programs: A comparison of student and sponsoring organisation decision considerations. *Journal of Marketing for Higher Education*, 11(1), 21-38.
- Connective Leadership Institute. (n.d.). Retrieved from Connective Leadership: <https://www.connectiveleadership.com/application-and-usage/>
- Contreras, J. L., & Ruff, E. S. (2002, September-October). MBA education in Latin America: The case of Chile. *Journal of Education for Business*, 51-55.
- Dailey, L., Anderson, M., Ingenito, C., Duffy, D., Krimm, P., & Thomson, S. (2006). Understanding MBA consumer needs and the development of marketing strategy. *Journal of Marketing for Higher Education*, 16(1), 143-158. doi:[https://doi.org/10.1300/J050v16n01\\_07](https://doi.org/10.1300/J050v16n01_07)
- Datar, S. M., Garvin, D. A., & Cullen, P. G. (2010). Rethinking the MBA: Business education at a crossroads. In *Rethinking the MBA: Business education at a crossroads*. Boston, MA, USA: Harvard Business Press.
- Dhingra, M. (2017). Higher Education and Professional Graduates' Employability Status - An Alarming Situation in India. *Amity Global Business Review*, 4.
- Dobson, G., Frye, R., & Mantena, R. (2013). Leadership training in an MBA program - Using peer-led team learning. *American Journal of Business Education*, 6(2), 177-190.
- Elliot, C., & Soo, K. T. (2016). The impact of MBA programme attributes on post-MBA salaries. *Education Economics*, 1.
- Financial Times. (n.d.). Retrieved April 16th, 2018, from Financial Times: <http://lexicon.ft.com/Term?term=global-leader>
- Gander, M. (2015). Higher education business management staff and the MBA: A small study analysing intrinsic and extrinsic benefits. *Journal of Education for Business*, 3.
- Goldgehn, L. A., & Kane, K. R. (1997). Repositioning the MBA: Issues and implications. *Journal of Marketing for Higher Education*, 8(1), 15-24.
- Gosser, D. K., Cracolice, M., Kampeier, J. A., Roth, V., Strozak, V., & Varma-Nelson, P. (2001). *Peer-led team learning: A guidebook*. Upper Saddle River, New York, NY, USA: Prentice Hall.
- Heslop, L. A., & Nadeau, J. (2010, June). Branding MBA programs: The use of target market desired outcomes for effective brand positioning. *Journal of Marketing for Higher Education*, 20(1). doi:10.1080/08841241003788110
- Johnson, J. W., Thomas, V., & Peck, J. (2010). Do specialised MBA programs cultivate alumni relationships and donations? *Journal of Marketing for Higher Education*, 20(1), 119-134.
- Kachra, A., & Schnietz, K. (2008). The capstone strategy course: What might real integration look like? *Journal of Management Education*, 32(4), 476-508.
- Keystone Academic Solutions. (2018). Retrieved from Keystone Academic Solutions: <http://www.maseterstudies.com>
- Lipman-Bluman, J. (1998, January/February). Connective Leadership: What business needs to learn from academe. *Change Magazine*, 49-53
- Lipman-Bluman, J. (2000). The age of connective leadership. *Leader to Leader*, 17(summer), 39-45
- Ma, S., & Trigo, V. (2011). Internationalisation of China's MBA education: Failing to walk the talk? *Journal of Teaching in International Business*, 22, 149-167.
- Mendez-Grant, M. (2001). A study of freshman interest groups and leadership practices at Texas Women's University. Unpublished doctoral dissertation, University of North Texas.
- Muff, K. (2012). Are business schools doing their jobs? *Journal of Management Development*, 31(7), 648-662.
- Nasiripour, S. (2017). Business Education. Retrieved from Business Education: <http://www.bloomberg.com/graphics/2017-best-business-schools/>

- Posner, B., & Brodsky, B. (1994). Leadership practices of effective student leaders: Gender makes no difference. *NASPA Journal*, 31(2), 113-120.
- Reiche, B. S., Mendenhall, M. E., Bird, A., & Osland, J. S. (2013, March). Retrieved from <http://www.worldfinancialreview.com/?p=859>.
- Roth, V., Goldstein, E., & Marcus, G. (2001). *Peer-led team learning: A handbook for team leaders*. Upper Saddle River, New York, NY, USA: Prentice Hall.
- Temtime, Z., & Mmereki, R. (2011). Challenges faced by graduate business education in Southern Africa: Perceptions of MBA participants. *Quality Assurance Education*, 19(2), 110-129.
- The Washinton Post. (n.d.). Retrieved April 19, 2018, from The Washington Post: <http://www.washingtonpost.com/sf/brand-connect/wp/enterprise/how-mba-leadership-training-can-bring-out-the-best-in-you/?noredirect=on>
- Thomas, G., Martin, R., & Riggio, R. E. (2013). Leading groups: Leadership as a group process. *Group Process and Intergroup Relations*, 16, 3-16.
- Thomas, H. (2007). An analysis of the environmental and competitive dynamics of management education. *Journal of Management Education*, 26(1), 9-21.
- Wellins, R. S., & Sinar, E. (2016, April 29). Retrieved from <http://fortune.com/2016/04/29/mba-programs-business-skills/>
- Which MBA? (2018). Retrieved from Which MBA?: <https://www.economist.com/whichmba/methodology-2017>

## ***Part 4: Finance & Banking***

# One-Sided Linking of Mortgage Loans to the Price of Foreign Currencies

Nahum Biger

Faculty of Management  
University of Haifa, Israel

## Abstract

Complex securities that are based on combinations of bonds and derivatives have become very common. The translation of such inventions to loans to private household borrowers changes the rules of the game of derivatives and this practice becomes potentially unfair. This paper demonstrates this contention by reference to one particular arrangement of home mortgage loans where the monthly payments are one-sided linked to a currency exchange rate. A real world example is described, and a pricing model is applied. The complexity of the valuation process is beyond comprehension even to intelligent rational borrowers. Hence, these types of loans are potentially unfair to naive borrowers.

**Keywords:** currency linked loans, one-sided linkage, put options, valuation model

## Introduction

In several countries, and in particular in countries with a 'weak currency', it is customary for banks and other lending institutions to offer their customers who wish to borrow funds, especially mortgage loans, an arrangement by which the payments or the servicing of the loan is linked to the price of a particular foreign currency. The loan is offered in terms of the local currency. The initial loan amount is translated into the designated foreign currency at the spot exchange rate and the monthly mortgage payment is computed in accordance with the interest rate that is contractually agreed upon with the borrower. The payments are in the form of 'blended payments' where each monthly amount contains both interest and principal, and determined in terms of the foreign currency. Then, the actual monthly amount is paid in the local currency where the amount payable in each month is determined by the local currency price of one unit of the foreign currency, or by the spot exchange rate that is in effect every time a payment is due.

This arrangement is rather customary in many countries, especially in small countries where lending institutions finance their operations by issuing foreign currency denominated securities. Thus, from the vantage point of the lending institution this type of foreign currency linked loans plays a role of a natural hedge against unexpected changes in the exchange rate.

In some cases, a special type of foreign currency linked loans has emerged. This type that became common practice by several lending institutions is a one-sided linkage to the exchange rate.

In many instances the borrower is not offered a choice between a two-sided regular foreign currency linked loan and a one-sided foreign currency linked loan.

We argue that such a loan is in most cases an unfair contract. If lenders (mortgage banks) may be able to assess the economic value of such loans, most borrowers (households) do not have the tools, the skills and the knowledge to assess the true cost of these loans. They fail to realize the loan agreement is unfair.



## *One-Sided Currency Linked Loans*

We describe such loans as contracts that are a combination of a regular foreign currency linked loan combined with a series of European put options on the foreign currency that the lender (the mortgage bank) receives from the borrower. We show the complexities of evaluating the value of these foreign currency options and derive some conclusions regarding the fair treatment of borrowers who agree to borrow under such conditions. We use the original Biger and Hull, 1982 foreign currency option pricing model<sup>1</sup> and indicate the implications of such loans.

### *Description*

The mortgage market and especially the home loan mortgage market have seen tremendous changes in recent years. In Israel, due to the daily changes in the exchange rate between the Israeli Shekel (NIS) and the US dollar, most mortgage lenders offered their customers loans that were fully linked to the dollar exchange rate<sup>2</sup>. The amount of the loan would be translated into US dollars at the spot exchange rate at the time the loan contract is signed. The dollar interest rate is agreed upon (fixed or variable as the case might be), and the monthly dollar payment is computed. Then each month the payment in local currency is determined by reference to the spot US dollar exchange rate. This type of a mortgage loan was very common in Israel until about four years when the US dollar started to weaken against the New Israeli Shekel (NIS).

Mortgage lenders then introduced a twist in the manner of foreign currency linked loans. They instituted a contract whereby the monthly payments were bounded from below, or had a floor. These contracts are the one-sided linked loans to the foreign exchange. In this type of an arrangement the initial spot exchange rate, or the basis rate,  $S_B$ , is recorded in the loan agreement. The monthly payments in terms of the local currency are then determined in the following manner:

$$\text{Monthly payment} = \begin{cases} \text{Foreign currency amount} \times S_T \text{ (the spot exchange rate)} & \text{if } S_T \geq S_B \\ \text{Foreign currency amount} \times S_B \text{ (the basic rate)} & \text{otherwise,} \end{cases}$$

where  $S_T$  is the spot exchange rate at date  $T$  of each monthly payment.

If one were to consider a one year zero-coupon loan that was provided under these terms, then the loan could be described as a combination of two components:

- a. A regular one-year loan where the payment of the principal is fully linked to the exchange rate or the local currency price of one unit of the foreign currency. The lender thus receives from the borrower an IOU that is fully linked to the local price of the foreign currency.
- b. A European put option – an option to sell the principal amount of the foreign currency loan at a price  $S_B$  to the borrower.

Thus, if the spot exchange rate upon maturity,  $S_T$ , is higher than  $S_B$ , the lender doesn't exercise the option. The lender receives  $S_T$  times the foreign currency value of the principal. If  $S_T < S_B$ , then

---

<sup>1</sup> Biger and Hull (1982).

<sup>2</sup> Definition: A bond in which the coupon and/or redemption value are linked to the movement in an exchange rate. Source: IMF, 2003, External Debt Statistics: Guide for Compilers and Users – Appendix 1. Special financial instruments and transactions: Classifications, IMF, Washington DC. See: <http://www.imf.org/external/pubs/ft/eds/Eng/Guide/index.htm>

the lender does exercise the put option, selling the foreign currency value of the principal at a price  $S_B$  to the borrower. Under these conditions the borrower pays the amount, in terms of the local currency, in accordance with the contract.

The arrangement becomes more complicated when the one-sided foreign currency linked loan is in a form of a mortgage loan. Consider such a loan that is to be paid back by monthly installments over a period of twenty years. The manner in which a 'regular' foreign currency linked loan would be tailored is as follows: the initial loan is first translated into the terms of the foreign currency. Assume that the loan is given at a fixed monthly rate of interest for the entire period. Then given the agreed upon monthly rate of interest the monthly foreign currency payment over the entire period is computed. Each month, the local currency payment is determined by multiplying the (fixed) foreign currency monthly amount by the spot exchange rate on the day of payment.

In case where the mortgage loan is given under condition of a one-sided linkage to the price of foreign currency, then the lender is effectively receiving from the borrower a set of 240 European put options. The first one expires in one month, the second in two months and so on, while the last one expires in 240 months. Each of these options provides the lender with the option to sell to the borrower the fixed amount of the foreign currency payment at the exchange rate  $S_B$ .

#### *An Example*

The following is a description of an actual case that took place in Israel. A person received a mortgage loan of NIS 1 million from a mortgage bank to purchase an apartment in Haifa, Israel. It was a 15 year loan, fully linked to the US dollar, both principal and monthly interest.

At the time, the rate of interest on the loan was 4% annually, or 0.327374% per month.

A one million NIS mortgage loan at an annual interest rate of 4% given for 15 years (180 months) with blended monthly payments – interest and principal, implies a monthly payment of NIS7,361.09.

The mortgage loan was contractually linked to the exchange rate of the US dollar. At the time the contract loan was signed, the exchange rate was NIS4.50 per dollar. This was the *BASIC RATE*,  $S_B$ , and this exchange rate was explicitly inserted in the loan contract.

Thus, a 'standard' mortgage loan that is fully linked to the NIS exchange rate of the dollar would be treated as follows:

At the exchange rate on contract date was NIS4.50 per US dollar, the monthly payment are equivalent to \$1635.80.

It follows that if, in a given month, the exchange rate is, say, NIS4.60 per dollar, then the NIS payment should be NIS7,524.67, not NIS7,361.09.

The loan contract explicitly stated the *BASIC RATE* of NIS4.50 per dollar. The monthly payments each month would therefore be NIS7,361.09, times the exchange rate on the day of payment,  $S_t$ , divided by the *BASIC RATE*.

$$[1] \dots \text{Monthly payment} = \text{NIS7,361.09} \times (S_t / S_B)$$

Before signing the mortgage loan agreement, the bank inserted another paragraph to the agreement: The bank insisted that the linkage to the exchange rate will be one-sided.

More specifically, the paragraph stated that if the exchange rate in any given month is higher than the *BASIC RATE*, then the monthly payment will be determined in accordance with the formula [1] above.

Otherwise, the payment will be the original NIS amount of NIS7,361.09

Simply stated, if the NIS price of the dollar rises above 4.50, the borrower pays more.

If the price of NIS price of the dollar falls below 4.50, *the borrower doesn't pay less.*

$$\begin{aligned}\text{Payment in month } t &= (7,361.09 \times S_t/S_B \text{ if } S_t \geq S_B \\ &= (7,361.09 \text{ otherwise}\end{aligned}$$

The lender (the bank) therefore is protected against a rise in the NIS price of the dollar, and doesn't suffer if the NIS price of the dollar falls below 4.50.

Such a loan agreement contains a one-sided linkage of the monthly payment to the exchange rate.

Consider the essence of such a loan and the economic difference between a 'regular' foreign currency denominated loan and a one-sided foreign exchange linked loan.

Furthermore – consider the potential harm to the borrower who agrees to accept such a loan and how should the borrower be compensated?

#### *The Economic Meanings of Such One-Sided Linked Loans*

A one-sided linked loan, or a loan with a floor, is a loan (or a deposit) where the currency linkage comes to a halt in cases where on payment due dates the actual exchange rate is lower than the basic exchange rate. In such cases the actual due payment is based on the basic exchange rate that is stated in the loan contract.

It is thus necessary to clarify the economic meaning of one-sided linkage, the complexity of the arrangement and in particular the difficulties of evaluating the fair value of such loan to the lender and to the borrower.

We start with a one year loan of NIS 4,500, linked to the exchange rate of the US dollar. The spot exchange rate is NIS4.50 (this is the *BASIS EXCHANGE RATE*), and therefore the loan is equivalent to \$1,000.

In one year the borrower must return the loan plus 4% interest. The payment will be the NIS equivalent of \$1,040, where the NIS amount will be determined according the exchange rate in one year.

Also assume that the lender (the bank) insists that the loan will be one-sided dollar linked loan, with a *BASIS EXCHANGE RATE* of NIS4.50 per dollar.

The borrower will then pay the bank at least NIS4,680 (\$1,040x4.50), but if the exchange rate in one year is higher than 4.50 the borrower pays more.

The loan can be describes as a regular dollar-linked loan, but in addition the lender (the bank) receives from the borrower an option to sell to the borrower, on due date, \$1,040 at a price of NIS4.50.

On due date, the borrower pays the lender the NIS equivalent of \$1,040 *according to the then spot exchange rate.*

With regard to the option given by the borrower to the lender, if on due date the exchange rate is higher than NIS4.50, the lender doesn't exercise the option, and receives \$1,040 times the new spot exchange rate. For example, if the exchange rate is NIS4.70, the lender gets NIS4,888

Conversely, if the spot exchange rate is lower than the BASE RATE of NIS4.50, for example if the exchange rate is 4.20, then if the loan were a regular dollar linked loan the lender would receive  $1,040 \times 4.20 = \text{NIS}4,368$ . But now the lender also exercises the option, gives the borrower \$1,040 and will receive NIS4.50 per dollar or NIS4,680.

The bank however purchases the \$1,040 at NIS4.20 per dollar, i.e. for NIS4,368.

As a result of purchasing the 1,040 dollars at 4.20 and exercising the option by selling the dollars at 4.50, the bank gains NIS312.

When the NIS312 gain is added to the direct proceeds from the payment according to the spot rate (NIS4,368), the banks' total proceeds amount to NIS4,680. This is what the borrower actually pays.

#### *Valuation – An example*

The option that is embedded in the one-sided linked loan is a European put option. Prior to expiration the option does have some economic value. The value depends upon several factors, one of which is the uncertainty about the exchange rate that will actually prevail on the day of payment.

Other factors are the spot exchange rate, the exercise price, the time to expiration of the option, the risk - free rates of interest on both currencies and the time to expiration.<sup>3</sup>

In a fair deal if the borrower is required to grant the lender the option, one may assume that the borrower should be entitled to get something in return.

The true exchange rate one year from now around the expected one year rate. The compensation could for instance be a proper reduction in the interest rate on the loan compared to the rate the borrower would be required to pay on a regular dollar linked loan. Alternatively, the value of the option should be subtracted from the initial loan amount and then the agreed upon interest rate will be used in order to determine the monthly dollar payments.

The next chart demonstrates the model to estimate the value of the put option. In the example the present exchange rate and the one year forward rate are both NIS4.50 per dollar. The annual interest rates on both currencies are 4% (or 0.327374% per month).

It is also assumed that the annual volatility of the exchange rate is 8%, reflecting the uncertainty or the 'ignorance' of the market regarding.

---

<sup>3</sup> The first European currency option model was developed by John Hull and Nahum Biger referred to above and published in 1982.

<b>Biger-Hull European Currency Options</b>		
$c = e^{-rT} [Fx N(d_1) - EX x N(d_2)]$		
By put-call parity: $p = c - e^{-rT} [EX - F]$		
where $d_1 = [\text{Ln}(F/EX) + 0.5\sigma^2 T] / \sigma T^{0.5}$		
and $d_2 = d_1 - \sigma T^{0.5}$		
<b>Application of the model for valuation:</b>		
<b>Data:</b>		
Monthly r	0.327374%	
T in months	12	
T in years	1	
Annual $\sigma$	8.00%	
$e^{-rT}$	0.9967	
F (NIS/\$)	≈ 4.50	
EX (NIS/\$)	≈ 4.50	
<b>Computations and results:</b>		
Ln (F/EX)	0.000	
$d_1$	0.0809	
$d_2$	0.0009	
N( $d_1$ )	0.5322	
N( $d_2$ )	0.5004	
Call options value	≈ 0.1430	
Put option value	≈ 0.1430	

F (NIS/\$)	Put Value	P as a % of F
4.45	0.1687	3.79%
4.40	0.1970	4.48%
4.35	0.2280	5.24%
4.30	0.2617	6.09%

Figure 1. Biger-Hull European currency options

The simplistic example just described demonstrates the essence of the one-sided linkage. A one sided foreign currency denominated loan is in actuality a ‘regular’ foreign currency denominated loan and in addition the lender (the bank) receives from the borrower (the household) a put option. The option has a certain value that provides the lender with an opportunity to enjoy both worlds: To receive higher amount when the exchange rate becomes higher than the *BASIC RATE*, and not to ‘suffer’ when the exchange rate is lower than the *BASIC RATE*.

The example demonstrates the complexity of such a loan.

But this example was a simple one dealing with a loan for one year where at the end of the year the borrower must pay back the principal plus interest.

Table 1. Payment of Principal and Interest in One Year (in NIS)

Exchange rate in one year (NIS/\$)	Payment with "Regular" two-sided linkage	Payment with one-sided linkage	Fair payment with consideration for the option
3.50	3,640.0	4,680.0	4,531.3
3.60	3,744.0	4,680.0	4,531.3
3.70	3,848.0	4,680.0	4,531.3
3.80	3,952.0	4,680.0	4,531.3
3.90	4,056.0	4,680.0	4,531.3
4.00	4,160.0	4,680.0	4,531.3
4.10	4,264.0	4,680.0	4,531.3
4.20	4,368.0	4,680.0	4,531.3
4.30	4,472.0	4,680.0	4,531.3
4.40	4,576.0	4,680.0	4,531.3
4.50	4,680.0	4,680.0	4,531.3
4.60	4,784.0	4,784.0	4,635.3
4.70	4,888.0	4,888.0	4,739.3
4.80	4,992.0	4,992.0	4,843.3
4.90	5,096.0	5,096.0	4,947.3
5.00	5,200.0	5,200.0	5,051.3
5.10	5,304.0	5,304.0	5,155.3
5.20	5,408.0	5,408.0	5,259.3

The following Figure displays the NIS payment of the principal and interest as a function of the exchange rate at the date of repayment under the two linkage arrangements:

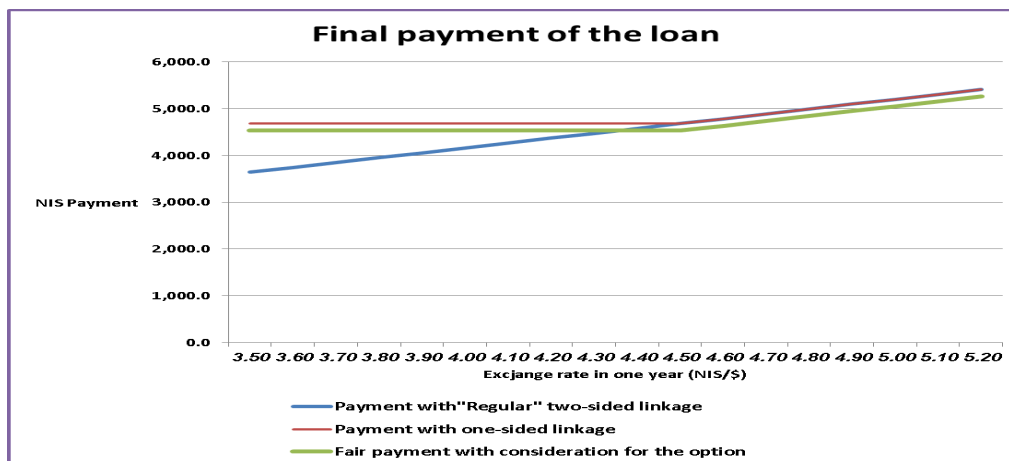

Figure 2. Final payment of the loan

In order to clarify the complexity of one sided foreign exchange denominated loans consider the actual real-world case that was described above.

A 15 year NIS 1.0 million mortgage loan with monthly blended payments, at 0.327374% interest per month, (4% annual rate), linked to the exchange rate of the dollar at the end of each month.

If the loan were to be a regular dollar denominated loan than the monthly payments would be computed by translating the NIS1.0 million into US dollars, i.e., \$222,222 at the spot exchange rate of 4.50, then compute the monthly dollar payment, \$1,635.80.

The payment of each of the 180 monthly payments would then be determined by multiplying the monthly dollar amount by the spot exchange rate in each month.

But since the loan is one sided linked to the exchange rate, the borrower actually received a 'regular' foreign currency denominated loan, but at the same time the borrower granted the lender (the mortgage bank) a bundle of 180 European put options, each of which enables the lender to sell \$1,635.80 at an exchange rate of NIS4.50 per 1 dollar, or for NIS7,361.10.

Each of these options has a different expiration date. The first expires in one month, the second – in two months and so on while the 'last' put option expires 180 months (15 years) from the initial date of the loan contract. It is well known that the longer the expiration period, the higher the value of the put option.

The economic value of the package of these European put options is complex. It is the sum of the values of each of these put options.

In to following table we use the Biger-Hull European currency options model to estimate the value of each of the 180 put options under the following assumptions:

- The spot exchange rate is equal to the forward exchange rate for each of the next 180 months (equivalent to the assumption that the term structure of interest rates on both NIS and the dollar are identical).
- The exchange rate (spot and forward) is NIS4.50 per US dollar.
- The interest rate ("risk free") in both countries is 4% per year.
- The annual volatility of the exchange rate is 8%.

None of these assumptions is more than an assumption, especially the assumption regarding the volatility.

The estimates below refer to the (European) put option to sell one dollar for NIS4.50 in one, two, three months and so on. The value of each of these options of course rises with the time to expiration and can be seen in Table 2.

**Table 2.** The Value of Each Put Option as a Function of the Number of Months to Expiration

Months to Expiration	PV of the option NIS/\$	Months to Expiration	PV of the option NIS/\$	Months to Expiration	PV of the option NIS/\$	Months to Expiration	PV of the option NIS/\$	Months to Expiration	PV of the option NIS/\$
1	0.03903	37	0.21035	73	0.26181	109	0.28349	145	0.28973
2	0.05500	38	0.21245	74	0.26271	110	0.28383	146	0.28975
3	0.06714	39	0.21451	75	0.26360	111	0.28416	147	0.28977
4	0.07727	40	0.21651	76	0.26446	112	0.28448	148	0.28978
5	0.08610	41	0.21847	77	0.26530	113	0.28479	149	0.28978
6	0.09400	42	0.22038	78	0.26612	114	0.28509	150	0.28978
7	0.10119	43	0.22224	79	0.26692	115	0.28538	151	0.28978
8	0.10781	44	0.22405	80	0.26771	116	0.28565	152	0.28981
9	0.11397	45	0.22582	81	0.26847	117	0.28592	153	0.28981
10	0.11973	46	0.22755	82	0.26922	118	0.28618	154	0.28982
11	0.12516	47	0.22924	83	0.26995	119	0.28642	155	0.28982
12	0.13028	48	0.23089	84	0.27066	120	0.28666	156	0.28983
13	0.13515	49	0.23250	85	0.27135	121	0.28689	157	0.28984
14	0.13978	50	0.23408	86	0.27203	122	0.28710	158	0.28984
15	0.14420	51	0.23561	87	0.27269	123	0.28731	159	0.28985
16	0.14843	52	0.23711	88	0.27333	124	0.28751	160	0.28985
17	0.15249	53	0.23858	89	0.27396	125	0.28770	161	0.28986
18	0.15638	54	0.24001	90	0.27457	126	0.28788	162	0.28986
19	0.16013	55	0.24141	91	0.27517	127	0.28805	163	0.28987
20	0.16374	56	0.24278	92	0.27575	128	0.28782	164	0.28987
21	0.16722	57	0.24412	93	0.27631	129	0.28710	165	0.28988
22	0.17058	58	0.24542	94	0.27686	130	0.28851	166	0.28988
23	0.17383	59	0.24670	95	0.27740	131	0.28865	167	0.28989
24	0.17690	60	0.24795	96	0.27792	132	0.28878	168	0.28989
25	0.18001	61	0.24917	97	0.27842	133	0.28890	169	0.28990
26	0.18296	62	0.25036	98	0.27892	134	0.28901	170	0.28990
27	0.18586	63	0.25153	99	0.27940	135	0.28911	171	0.28991
28	0.18860	64	0.25266	100	0.27986	136	0.28921	172	0.28991
29	0.19129	65	0.25378	101	0.28032	137	0.28930	173	0.28992
30	0.19391	66	0.25486	102	0.28076	138	0.28938	174	0.28992
31	0.19646	67	0.25593	103	0.28118	139	0.28945	175	0.28999
32	0.19893	68	0.25696	104	0.28160	140	0.28951	176	0.28993
33	0.20134	69	0.25798	105	0.28200	141	0.28957	177	0.28994
34	0.20368	70	0.25897	106	0.28239	142	0.28962	178	0.28994
35	0.20596	71	0.25994	107	0.28277	143	0.28967	179	0.28994
36	0.20818	72	0.26089	108	0.28313	144	0.28970	180	0.28995

The recipient of the loan, the borrower, gave the lender (the bank) a bundle of 180 European put options, each of which is for the sale of 1 dollar at a price of NIS4.50.

The total value of the 180 put options that the borrower grants the lender is NIS 64.92.

The present value of the 180 payments of \$1.00 payments at an annual rate of interest of 4% is \$135.85.

Translated into dollars at the spot exchange rate that is also the *BASIC RATE*, the dollar value of the 180 put options is \$14.426.

The value of these options is then 10.62% of the value of the loan.

When the loan contract was arranged, the monthly dollar equivalent of the payments was computed based on the agreed upon 4% rate of interest, but these computations were made without due regard to the value of the 180 put options granted by the borrower to the lender.

The determination of the monthly dollar equivalent payments under the condition of one-sided linkage to the exchange rate should have been done with explicit consideration of the value of the options that the lender (the bank) insists on getting from the borrower.

In our example, the value of the options is about 10.62% of the present value of the loan.

Therefore, in a fair deal the determination of the monthly dollar equivalent payment should have been based on the total value of the loan less the value of the options.

In our case, the monthly dollar equivalent payments should have been based not on a total loan of \$222,222, but on a total loan of only \$198,622, and the monthly dollar equivalent payments should have been \$1,445.72 and not \$1,635.80.

The monthly payments should have been only 89.38% of what the borrower was actually charged.

On a loan of NIS 1.0 million the minimum monthly payments were determined to be NIS 7,361.09.

According to the estimates presented above, taking into consideration the value of the 180 options granted by the borrower to the lender, the minimum monthly payment should have only been NIS 5,579.34.

The present value of the 180 options in our example was \$23,600, or NIS 106,200.

This is the damage that the naïve borrower suffers.

It should be noted that what was presented here was only an example, based on a set of assumptions regarding the "input" of the option pricing model. Different insertions would render different values of the bundle of the options. In periods of higher uncertainty regarding the exchange rates of the future, the volatility estimates will probably be higher and the value of the entire package of the put options will be higher as well. It follows that an arrangement of a home mortgage loan that is one-sided linked to the exchange rate is likely to be even less fair to the borrower.

#### *Normative Background and Behavioral Characteristics*

The analysis presented above clearly demonstrates that one-sided linked loans are at least problematic from the vantage point of the borrower. It is clear that in some circumstances where the borrower can't evaluate the economic meaning of the loan contract, the contract harms his interests. However such contracts are common and therefore one should examine the normative background and the behavioral characteristics of such contracts. Several legal issues may also be connected to such loan arrangements.

In the US the central law dealing with loans is the Consumer Credit Act that deals with consumers arrangements related to credits with no specific definition of a loan. In the United States the law dealing with loans in the Truth in Lending Act that deals with the duty to reveal all details regarding the true cost of debt.



Western European countries, mainly Germany, France, Italy and also the Russian Federation with the Civil Code, adopted another approach and enacted laws that regulate legally the essence of the loan contract and the specific arrangements of each contract.

### *The Behavioral Aspects*

From the economic analysis it is clear that a one-sided linked loan contract from the vantage point of the borrower is not purely economically rational. It fails to attain an economic equilibrium in that it is generally biased in favor of the lender.

Explanations of the irrational willingness of borrowers to accept such loans might be found in areas of consumer behavior that are not purely economic but that are related to the principles of behavioral science. This analysis touches upon two disciplines, economics and law. The leading explanation of the borrowers' willingness to accept such contracts is that even when borrowers are cognizant of some binding terms in the loan contract, such as one-sided linkage, they can't weigh the costs versus the benefits and arrive at rational decisions. In some cases borrowers will tend to totally ignore these caveats because they don't have knowledge or the tools to evaluate the costs in order to request proper compensation for granting the put options that are embedded in the loan contract to the lender.

Kahneman and Tversky who studied the psychological biases<sup>4</sup> found that tendency to ignore low probability events (in our case the decline of the exchange rate), over optimism and self assurance create the phenomenon that borrowers tend to ignore specific items in the loan contract. Such behavior is typical when the contract special terms are not part of the regular life of the loan contract, and borrowers will tend to ignore these terms if the past experience was that such events (falling price of the foreign currency) don't really occur.

Another explanation to the seemingly irrational behavior of borrowers is proposed by Becher<sup>5</sup> who suggests that people have strong preference to the present over the future and therefore they tend to underestimate future risk and loss of benefits.

### **Conclusions**

The use of complex securities by financial institutions is wide spread. Financial engineering is common in many transactions between major borrowers and lenders. In many instances it is difficult to actually assess the value of such complex securities but lenders and borrowers agree on terms and conditions embedded in such complex securities. It is conceivable that the acceptance of such complex securities by major lenders and borrowers reflects the fact that these actors operate on the basis of well diversified portfolios and therefore the inability to properly assess the value of each of these complex securities faded away or being diversified.

At variance, when the use of complex securities such as one-sided currency linked loans are offered to individual households or to family borrowers, the implications are different. First, the borrower fails to recognize that by accepting such a loan, she unknowingly gives the lender a valuable bundle

---

<sup>4</sup> Daniel Kahneman and Amos Tversky, (1974), *Judgment under Uncertainty: Heuristics and Biases*, 185 Science 1124.

Daniel Kahneman and Amos Tversky, (1979), *Prospect Theory: An Analysis of Decision under Risk*, 47(2) Econometrica 263.

<sup>5</sup> Shmuel I. Becher, (2007), *Behavioral Science and Consumer Standard Form Contracts*, Louisiana Law Review, Vol. 68, pp. 117-182.

of options. In particular, the borrower has no clue as to the value of the bundle of options that the lender demands and thus fails to request a proper compensation for the options. Second, the borrower has no way to hedge the risk or to undo the gift that she gives to the lender, or to unbundle the package in any way. No currency options for up to 15 years expiration time exists. Third, the demonstration that was presented in the paper is only an example. Even the lending institution that may employ a well-equipped financial economics department with top analysts can't determine the true value of the put option package because future risk-free short term interest rates are at best a reflection of what the market now believes these rates will be in the future, but such beliefs or perceptions may change tomorrow. Furthermore, nobody truly knows or has any reliable clue as to the volatility of exchange rates in the future. After all, these 'volatilities' are nothing but a reflection of our ignorance regarding the extent to which exchange rates in the future will be different from the expected.

It follows that such one-sided currency linked mortgage loans, or household loans, being potentially unfair, should not be offered. This will be very much in line with the Biblical rule of conduct: The Bible states (Leviticus 19:14): "You shall not curse the deaf nor place a stumbling block before the blind; you shall fear your God - I am your Lord."

## References

- Biger, N. and J. Hull, 1982. The valuation of currency options. *Financial Management*, 12(1): 24-28.
- IMF, 2003, *External Debt Statistics: Guide for Compilers and Users – Appendix 1. Special financial instruments and transactions: Classifications*, IMF, Washington DC. See:  
<http://www.imf.org/external/pubs/ft/eds/Eng/Guide/index.htm>
- Consumer Credit Act, 1974. c. 39. § 9 – 10 ( Eng)
- Daniel Kahneman and Amos Tversky, (1974), *Judgment under Uncertainty: Heuristics and Biases*, 185 *Science* 1124.
- Daniel Kahneman and Amos Tversky, (1979), *Prospect Theory: An Analysis of Decision under Risk*, 47(2) *Econometrica* 263.
- Shmuel I. Becher, (2007), *Behavioral Science and Consumer Standard Form Contracts*, *Louisiana law Review*, Vol. 68, pp. 117-182.

# Market Related and Market Independent Components of Company Stock Return in Bangladesh: Which is Stronger?

Sumaiya Zaman

ULAB School of Business  
University of Liberal Arts Bangladesh, Bangladesh

## Abstract

The paper aims to determine the strength of factors that contribute to the stock return of a firm operating in the capital market of Bangladesh. There are 302 companies trading their stocks in the Dhaka Stock Exchange (DSE). Of them, 233 DSE listed companies are chosen for the research owing to data availability for the almost 18-year period of January 2000 to November 2017. The select companies represent 17 industrial sectors. Market related and market independent components of return are selected as explanatory variables. Statistical tools as multivariate regression and descriptive statistics have been applied on the 233 company observations. It is seen that select variables can positively explain average return from equity investment in Bangladesh.

**Keywords:** company stock return, single index model, equity market, multi-variate regression, Dhaka stock exchange

## Introduction

A report from the BMI Research in 2016 has shortlisted the "10 emerging markets of the future" - the countries that are set to become new drivers of economic growth over the next 10 years. According to the report, these countries will cumulatively add US dollar 4.3 trillion to global GDP by 2025, which is roughly equivalent to the economy of Japan in 2016. Bangladesh has been identified as one of the 10 emerging economies along with Egypt, Ethiopia, Indonesia, Kenya, Myanmar, Nigeria, Pakistan, Philippines and Vietnam. The sectors that will drive the economies are mainly manufacturing and construction, with Bangladesh, Myanmar, and Pakistan set to emerge as the new manufacturing hubs. Construction growth is forecasted to be widespread across all the countries, mainly to support increase in urban population and to facilitate the manufacturing sector (BMI research, 2016).

Bangladesh, a South Asian promising economy, has recorded a GDP growth of 7.2% in 2017, the highest in the region (Rapp & Vandermeij, 2018). Like any other economy, its capital market pays a significant role in its economic development and growth. The country has two security exchanges operating in its market: the Dhaka Stock Exchange Limited and the Chittagong Stock Exchange Limited. The necessity to establish a stock exchange in Bangladesh arose in 1952, before the country embraced its independence in 1971. The East Pakistan Stock Exchange Association Limited, the first bourse of the country, was incorporated on 28 April 1954. The formal trading started two years later in 1956 at Narayanganj after certificates of commencement of business were obtained. The name of the security exchange was revised to East Pakistan Stock Exchange Limited on 23 June 1962, two years after which, it was re-revised to its current name "Dhaka Stock Exchange Limited" on 14 May 1964. At the time of incorporation, the authorized capital of the exchange was Pakistan rupees 300,000 divided into 150 shares. In 2017, the total market capitalization of the Dhaka Stock Exchange is worth Bangladesh taka 4,228,945 million

(approximately US dollar 50,705 million) with 302 companies trading their equities in the capital market (Dhaka Stock Exchange Ltd.).

The Chittagong Stock Exchange Limited was incorporated in Chittagong, the second largest city of Bangladesh, on 1 April 1995. The trading in the bourse began on 10 October 1995 with 30 listed securities and with the market capitalization of Bangladesh taka 10,574 million (approximately US dollar 176 million) (Solaiman, 2005). In 2017, the total market capitalization of the Chittagong Stock Exchange is worth Bangladesh taka 3,528,911 million (approximately US dollar 42,312 million) with 271 companies trading their equities in the exchange (Chittagong Stock Exchange Ltd.).

Bangladesh has witnessed two stock market crashes, in 1996 and in 2010. In 1996, the index point of Dhaka Stock Exchange (DSE) jumps from about 800 points in June to around 3,600 points in November starting with a base of 350 points (Ahmed, Uchida, & Islam, 2012). The index reaches the highest on 5 November 1996 with 3,648.75 points, dropping sharply the next day, and reaching to 462 points in May 1999. A probe committee created in December 1996 submits its report to government in March 1997, identifying several companies, big brokers, and influential individuals to be involved in the market rigging (Hoque, 2007; The Daily Star, 2015).

The capital market of Bangladesh experiences a second bubble burst in 2010. The general index reaches its all-time high of 8,918.51 points on 5 December, preceded by a sharp rise in October-November. The index begins to drop dramatically the next day. On 19 December 2010, the market sees the biggest one-day fall in its 55 year history that surpasses the fall in 1996 market (Ahmed et al., 2012; BBC News, 2011). A probe committee (Khaled, 2011 as cited in Islam & Ahmed, 2015) is formed to investigate the stock market scam. The committee finds responsible 60 influential individuals along with an array of irregularities, including the existence of omnibus accounts that allowed key market players to make excessive profits at the cost of the retail investors. Choudhury (2013) points out that lack of restriction on opening beneficiary owner (B/O) accounts, speculation through omnibus accounts, wrong placement of IPOs, violation of banking act, rumor spread by the brokers and the dealers, wrong method used in face value determination and lack of monitoring in the share market are behind the stock market crash in Bangladesh (as cited in Islam & Ahmed, 2015).

The probe panel recommends several actions to protect the capital market from future misfortune, demutualization of the bourses being one recommendation. The demutualization law is passed in parliament in April 2013 to bring transparency to the market. Under demutualization rules, 25 percent shares of the bourses are to be kept in a block account for strategic investors, 35 percent are to be set aside for institutional and individual investors, and 40 percent are to be owned by existing shareholders, commonly known as stockbrokers and stock dealers (The Daily Star, 2016). The DSE's demutualization scheme consists of 1,803,776,500 shares worth a total US dollar 218 million in paid-up capital, given a face value of 12 cents per share. A Chinese consortium, comprising the Shanghai Stock Exchange and the Shenzhen Stock Exchange (SZSE), submits a bid of US dollar 119 million, for 450.9 million shares, that shows their readiness to pay 30 cents per share. The consortium also offers free technical support worth around US dollar 36 million for 10 years. An Indian consortium, comprising the National Stock Exchange (NSE), the USA's NASDAQ and Frontier Bangladesh quote 18 cents per share, amounting to a bid of US dollar 87 million, with no specific plan of technical support (Asia Times, 2018). On 10 February 2018, the

Dhaka Stock Exchange directors decide to accept the proposal of the Chinese Consortium as it look acceptable to them regarding financial and technological aspects (bdnews24.com, 2018).

The past and recent events have given an incentive to author to identify the factors that have an effect on stock return in the capital market of Bangladesh. Return on stocks has two components, dividend yield and capital gain that comes from change in stock price. A study in 2010 shows that variation in returns on stocks cannot be strongly explained by variation in their respective dividend policy in the Dhaka Stock Exchange(Zaman, 2011). The paper, therefore, focuses on stock price change to understand stock return in the equity market of Bangladesh. Several factors including company performance and information, dividends, stock prices of other countries, gross domestic product, exchange rates, and interest rates have an impact on daily stock prices (Kurihara, 2006). The paper attempts to determine the factors that make an impact on stock price change that in turn plays a role in stock return in the capital market of Bangladesh. The objectives of the study are:

- i. Studying return on stocks of companies listed in the Dhaka Stock Exchange during the period of January 2000 to November 2017.
- ii. Measuring the strength of factors that influence the return on stocks of the select institutions during the period of study.

The paper begins with an introduction to the economy of Bangladesh, its bourses, and its capital market. The paper, then, provides with a review of relevant literature on stock return and its determinants. This is followed by the methodology adopted by the research. The next section showcases the empirical model and findings resulting from the analysis. The paper ends with a conclusion on the research conducted.

## **Literature Review**

Numerous studies have been done aiming to understand the factors that have an impact on expected return of equity investment. Different researches have attempted to identify and explain factors that can best estimate expected return. The traditional Capital Asset Pricing Model (CAPM) is known to provide the first framework to explain how risk of an investment should have an effect on its expected return. The model first came into being in the early 1960's. The contributors were William Sharpe (1964), Jack Trynor (1962), John Lintner (1965a, b), and John Mossin (1966). The model calculates expected return of a stock considering two components: the risk premium of the equity market and the beta of the stock. The model, however, does not take into account several factors like, the component of the stock's return that is uncorrelated with market as it can be diversified and the growth rate of the stock's expected future cash flows (Perold, 2004). Another study has suggested that expected return of stock be estimated through stock price, book values, and realized earnings rather than biased earning forecasts (Sommers, 2007). Similarly, a different research has attempted to prove that estimating expected return of equity investment on the basis of price-earnings ratio and-or price-earnings ratio divided by short term earnings growth rate may lead to bias results (Easton, 2004).Expected stock returns of a firm are influenced by shocks to expected cash-flows (i.e., cash-flow news) and/or shocks to discount rates (i.e., expected-return news). Campbell (1991) and Campbell and Ammer (1993) show that alarge number of researches have measured the relative importance of cash-flow and expected-return news for aggregate portfolio returns (as cited in Vuolteenaho, 2002).While selected aggregate cash-flow proxies, like contemporaneous and future dividend growth rates, tend to account for a large portion of aggregate

stock return, at the individual stock level, however, earnings and other cash-flow proxies account for a small portion of annual stock return (Hecht & Vuolteenaho, 2006). The expected stock return of an individual firm seems to have two components: changes in cash-flow expectations (i.e. cash-flow news) and changes in discount rates (i.e. expected-return news). The VAR yields three main results. The firm-level stock returns are primarily influenced by cash-flow news, while cash-flow news can largely be diversified away in aggregate portfolios (Vuolteenaho, 2002). It is, further, seen that high book-to-market firms seem to earn higher expected returns than low book-to-market firms. A strong positive relationship between expected return and market beta is also observed, with a negative relationship between expected return and firm size (Brav, Lehavy, & Michaely, 2005). A major factor inducing stock trades and, therefore, a contributor to equity expected return is Disagreement. Disagreement about variances has systematic and significant effects on price as more disagreement seems to lead to higher prices. Prices are also very sensitive to the degree of disagreement: Even if the average belief about the variance is constant, tiny fluctuations in the disagreement about the variance can lead to substantial price fluctuations (Duchin & Levy, 2010). Investor recognition is another discrete major predictor of stock price movements. While realized stock returns are strongly positively related to changes in investor recognition, expected returns are strongly negatively related to the level of investor recognition. It is seen also that investor recognition, as measured by sentiment, index membership, exchange listing, analyst coverage etc., dominates stock price movements over short horizons, whereas fundamentals dominate over longer horizons (Richardson, Sloan, & You, 2012).

The researches done so far to understand and measure expected return can be summarized in a simplified form in William Sharpe's Single Index Model. The Single Index Model says that expected return has two components: a market related part as indicated by  $\beta$  and a unique part as indicated by  $\alpha$ . The unique part is unrelated or insensitive to market return. These two components tend to explain the expected return on a stock (Elton, Gruber, Brown, & Goetzmann, 2009).

The paper aims to examine if the statistically proven theories hold true for the equity market of Bangladesh. The paper, thus, seeks to study if commonly discussed variables have the capacity to account for the expected return of stocks in the equity market of Bangladesh.

## **Methodology**

This section shows the sample chosen for the study. Data collection and data source are also discussed. Finally, the empirical model that the research comes up with is presented.

### *Sample*

The paper attempts to identify the significant determinants of return on stocks of companies listed in the Dhaka Stock Exchange during the period of January 2000 through November 2017. There are 302 companies listed in the Dhaka Stock Exchange in 2018 trading their stocks. The companies are categorized into 18 sectors. Of 302, 233 companies have been selected for the study on the basis of availability of data. The number of companies chosen from each sector is:

1. Bank: 25 of 30
2. Cement: 7 of 7
3. Ceramics: 4 of 5

4. Engineering: 28 of 36
5. Financial institutions: 22 of 23
6. Food and allied: 11 of 18
7. Fuel and power: 18 of 18
8. Insurance: 32 of 47
9. IT sector: 6 of 8
10. Jute: 2 of 3
11. Miscellaneous: Nil of 12
12. Paper and printing: 2 of 2
13. Pharmaceuticals and chemicals: 25 of 28
14. Services and real estate: 4 of 4
15. Tannery industries: 4 of 6
16. Telecommunication: 2 of 2
17. Textile: 38 of 49
18. Travel and leisure: 3 of 4

The companies selected are listed in the Chittagong Stock Exchange as well.

#### *Data Source*

The study uses mainly secondary data that have originally been and published by the Dhaka Stock Exchange. Literature relevant to the research has been studied and collected from published journals, newspapers, and magazines.

#### *Empirical Model*

The paper studies the determinants of return on stocks of the Dhaka Stock Exchange listed companies during the period of January 2000 through November 2017. The dependent variable, average company stock return, has been measured by:

$$E(R_i) = \text{average of } R_{it} \quad (1)$$

Where,  $E(R_i)$  represents the average return on stock of company “i” and  $R_{it}$  represents the daily return on stock of company “i” on day “t”. The return on stock is composed of capital gain and dividend yield, where capital gain is computed from change in stock price over time (Ross, Westerfield, & Jaffe, 2012). It has been seen that stock return cannot be strongly explained by dividend in the capital market of Bangladesh (Zaman, 2011). The daily return on stock in this study has, therefore, been calculated as:

$$R_{it} = (P_{it} - P_{it-1}) / (P_{it-1}) \quad (2)$$

Where,  $P_{it}$  stands for stock price of company “i” on day “t” and  $P_{it-1}$  represents stock price of company “i” on the day preceding day “t”.

According to Single Index Model, the return on stocks has two components; a market component and a component independent of market. The two explanatory variables of average company stock return are represented by  $C_i$  and  $S_i$ , where  $C_i$  represents the component of return on stock “i” that is independent of the market. It is often termed as the company specific return, meaning the return

on a stock that comes owing to the company's performance and information. S stands for the market component of return on stock "i". It represents the expected change in return on stock "i" with a unit change in the return from market portfolio (Elton et al., 2009). The daily return on market portfolio has been computed as:

$$R_{mt} = (P_{mt} - P_{mt-1}) / (P_{mt-1}) \quad (3)$$

Where,  $P_{mt}$  stands for the Dhaka Stock Exchange General Index on day "t" and  $P_{mt-1}$  represents the Dhaka Stock Exchange General Index on the day preceding day "t".

$C_i$  and  $S_i$  for each company are obtained through time series regression, which is by regressing the daily stock returns of each company on the daily return from market portfolio (Bilbao, Arenas, Jiménez, Gladishl, & Rodríguez, 2006).

The average company stock returns of the select 233 companies are regressed on the company specific returns and market related returns of the sample units using multivariate regression. The objective is to devise a statistically significant model that would explain the average stock return in terms of company specific return and market related return. The equation of the regression is:

$$Y_i = \alpha_i + \sum_{i=1}^n \beta_i X_i + \varepsilon_i \quad (4)$$

Where,  $Y_i$  is the measure of average stock return for company "i".  $\alpha_i$  is the slope.  $\beta_i$  represents parameter of the econometric model for return component " $X_i$ ", while  $\varepsilon_i$  is the error term.

Statistical tools as Wald (z-statistic) and chi-square have been applied to test the significance of the explanatory variables and goodness of fit of the model. Karl Pearson's coefficient of correlation (r) has been applied to test the multi-collinearity among the explanatory variables.

## Findings

Summary statistics of response and explanatory variables show that the sample companies have an average stock return close to 1% as mean with a maximum average return of 2.4% and a minimum of -4%. The sector that has the highest mean of average stock return is Jute, showing a figure close to 6%, while Travel and Leisure industry has the lowest average stock return with a mean close to -0.03%. The component of stock return independent of market shows a negative value (-6%) as mean for all the select companies. Pharmaceuticals and Chemicals record the lowest and a negative mean value for the component of stock return independent of the market, which is -61%, while the sector where market independent return is the biggest contributor to average stock return is Jute industry with a mean of 6%. While the market independent component of return has an inverse effect on the average stock return in the Pharmaceuticals and Chemicals sector, their biggest contributor to average return is the market component with a mean value of 937. The sector where average stock return gets the most negatively affected by the market is Jute, with a mean market component of -4 (See Table A1).

Multivariate regression has been run on the explanatory variables to devise a statistically significant model that would explain the strength of the explanatory variables in explaining average stock return of companies operating in the capital market of Bangladesh. Probability of chi-square statistic, in other words, the p-value, is calculated for the model. As the model gives a



p-value (0.0000) less than  $\alpha$  (0.05), it is chosen to be statistically significant. Output of the model is summarized in Table 3.

**Table 1.** Output of Multivariate Regression Model for Years 2000 - 2017

Average stock return	Coefficient	Standard error	z	P> z	[95% Confidence Interval]	
Market independent	0.8708	0.0213	40.83	0.000	0.8288	0.9128
Market component	0.0006	0.000014	40.97	0.000	0.0005	0.0006
Constant	0.0017	0.0008	2.31	0.022	0.0002	0.0032

Wald statistics (z-values) are determined by dividing coefficients of explanatory variables by their respective standard errors. Probabilities of z-values, which are the p-values, denote if coefficients of explanatory variables are significantly different from “zero” and hence, if null hypothesis can be rejected. P-values of the variables in the model are less than  $\alpha$  (0.05) and thus, are statistically significant. The model can be summarized as:

$$\text{Average stock return} = 0.0017 + 0.87 \text{ Market Independent} + 0.0006 \text{ Market Component} + \varepsilon \quad (5)$$

$$(0.0008) \quad (0.021) \quad (0.000014)$$

$$n = 233, \text{ Adj R-squared} = 0.8791$$

Regression model shows that rise in component of return independent of market by one unit brings about almost a unit increase in average stock return ceteris paribus, while a unit change in the market component of stock return will bring about almost negligible change in the average return on equity investment in the capital market of Bangladesh.

## Conclusions

The purpose of the study is to devise a model that would explain the strength of the components contributing to the return on stocks of companies listed in the Dhaka Stock Exchange during the period of January 2000 to November 2017. It has been seen that both market component and market independent component of returns have positive impact on the average stock return in the equity market of Bangladesh. The component of return independent of the market seems to play a bigger role in the average stock return. It can, therefore, be said that stock price fluctuation occurs mainly owing to company performance and company specific news and comparatively less due to the overall performance of the market in Bangladesh.

The paper opens up scope for further research that will address:

- Role of Industry performance and Industry specific news on the overall stock return of a company operating in Bangladesh.
- How to quantify company specific news and measure its impact on company stock return in Bangladesh.

## References

- Ahmed, S. U., Uchida, S., & Islam, Z. M. (2012, March). Stock Market Crashes: Reasons and Implications. KEIEI TO KEIZAI, 91(4).  
 Asia Times. (2018, February 21). China beats India to slice of Dhaka Stock Exchange. South Asia.

- BBC News. (2011, January 10). Bangladesh stock market fall: Clashes hit Dhaka. BBC News.
- bdnews24.com. (2018, February 2). Dhaka Stock Exchange greenlights China bourses as strategic partners as India, US lose out. Bangladesh.
- Bilbao, A., Arenas, M., Jiménez, M., Gladishl, B. P., & Rodríguez, M. V. (2006, December). An Extension of Sharpe's Single-Index Model: Portfolio Selection with Expert Betas. *The Journal of the Operational Research Society*, 57(12), 1442-1451.
- BMI research. (2016). Ten emerging markets of the future: highlighting key sectors. Kuala Lumpur: BMI Research.
- Brav, A., Lehavy, R., & Michaely, R. (2005). Using Expectations to Test Asset Pricing Models. *Financial Management*, 34(3), 31-64.
- Chittagong Stock Exchange Ltd. (n.d.). Background. Retrieved February 27, 2018, from Chittagong Stock Exchange: <http://www.cse.com.bd/mission.php#bg>
- Dhaka Stock Exchange Ltd. (n.d.). Introduction to DSE. Retrieved February 27, 2018, from Dhaka Stock Exchange Ltd.: <http://www.dsebd.org/ilf.php>
- Duchin, R., & Levy, M. (2010, June). Disagreement, Portfolio Optimization, and Excess Volatility. *The Journal of Financial and Quantitative Analysis*, 45(3), 623-640.
- Easton, P. D. (2004, January). PE Ratios, PEG Ratios, and Estimating the Implied Expected Rate of Return on Equity Capital. *The Accounting Review*, 79(1), 73-95.
- Elton, E. J., Gruber, M. J., Brown, S. J., & Goetzmann, W. N. (2009). *Modern portfolio theory and investment analysis* (9 ed.). New York: John Wiley & Sons.
- Hecht, P., & Vuolteenaho, T. (2006). Explaining Returns with Cash-Flow Proxies. *The Review of Financial Studies*, 19(1), 159-194.
- Hoque, H. A. (2007). Co-movement of Bangladesh stock market with other markets: co-integration and error correction approach. *Managerial Finance*, 33(10), pp. 810-820.
- Islam, K. M., & Ahmed, S. F. (2015, September). Stock Market Crash and Stock Return Volatility: Empirical Evidence from Dhaka Stock Exchange. *Bangladesh Development Studies*, 38(3), 25-34.
- Kurihara, Y. (2006). The Relationship between Exchange Rate and Stock Prices during the Quantitative Easing Policy in Japan. *International Journal of Business*, 11(4), 375-386.
- Perold, A. F. (2004). The Capital Asset Pricing Model. *The Journal of Economic Perspectives*, 18(3), 3-24.
- Rapp, N., & Vandermeij, A. (2018, February 23). These Are the Countries That Have Grown the Most in the Last Year. *Fortune*.
- Richardson, S., Sloan, R., & You, H. (2012, March/ April). What Makes Stock Prices Move? Fundamentals vs. Investor Recognition. *Financial Analysts Journal*, 68(2), 30-50.
- Ross, S., Westerfield, R., & Jaffe, J. (2012). *Corporate Finance* (10 ed.). New York: McGraw-Hill/Irwin.
- Solaiman, S. M. (2005). SECURITIES MARKET IN BANGLADESH: A CRITICAL APPRAISAL OF ITS GROWTH SINCE ITS INCEPTION IN 1954. *Savings and Development*, 29(2), 169-198.
- Sommers, P. D. (2007, December). Effect of Analysts' Optimism on Estimates of the Expected Rate of Return Implied by Earnings Forecasts. *Journal of Accounting Research*, 45(5), 983-1015.
- The Daily Star. (2015, August 5). Tribunal moves on 1996 stock scam. *The Daily Star*.
- The Daily Star. (2016, October 2016). DSE on the lookout for strategic partners. *The Daily Star*. Bangladesh.
- Vuolteenaho, T. (2002, February). What Drives Firm-Level Stock Returns? *The Journal of Finance*, 57(1), 233-264.
- Zaman, S. (2011, July). Is Dividend Policy An Important Determinant Of Market Performance: Focus On Private Banks Of Bangladesh. *World Review of Business Research*, 1(4), 135-144.

## Appendix

### Descriptive Statistics of Response and Explanatory Variables

#### Descriptive Statistics of Response and Explanatory Variables of the Select Dhaka Stock Exchange Listed Companies For Years 2000-2017

		Mean	Median	Standard Deviation	Min	Max	Count
All Companies	Average Return	1%	0.05%	3%	-4%	24%	233
	Market Independent	-6%	0.01%	97%	-1475%	24%	233
	Market Component	101	0.60	1475	-8	22515	233
Bank	Average Return	3%	0.04%	5%	-0.09%	23%	25
	Market Independent	3%	0.03%	5%	-0.14%	23%	25
	Market Component	0.49	0.51	0.55	-0.14	3	25
Cement	Average Return	0.06%	0.06%	0.04%	0.00%	0.09%	7
	Market Independent	0.03%	0.04%	0.05%	-0.06%	0.09%	7
	Market Component	0.46	0.38	0.42	0.01	1.01	7
Ceramics	Average Return	0.96%	0.89%	1.11%	0.00%	2%	4
	Market Independent	0.90%	0.84%	1.10%	-0.07%	2%	4
	Market Component	1.11	1.08	0.11	1.00	1.26	4
Engineering	Average Return	1%	0.04%	1%	-0.27%	4%	28
	Market Independent	1%	0.01%	1%	-0.28%	4%	28
	Market Component	0.64	0.58	0.64	-0.197	3	28
Financial Institutions	Average Return	0.23%	0.00%	2%	-4%	8%	22
	Market Independent	-1%	-0.04%	4%	-17%	8%	22
	Market Component	0.64	0.75	0.71	-0.08	3	22
		Mean	Median	Standard Deviation	Min	Max	Count
Food and Allied	Average Return	3%	0.09%	7%	-0.08%	24%	11
	Market Independent	3%	0.08%	7%	-0.07%	24%	11
	Market Component	0.34	0.00	1.3	-0.69	4	11
Fuel Power	Average Return	0.96%	0.05%	3%	-0.05%	13%	18
	Market Independent	0.92%	-0.002%	3%	-0.14%	13%	18
	Market Component	0.43	0.36	0.43	-0.12	1.09	18
Insurance	Average Return	1.06%	0.06%	3%	-0.17%	14%	32
	Market Independent	1.14%	0.01%	3%	-0.20%	14%	32
	Market Component	0.81	0.82	0.41	-0.30	1.41	32
IT Sector	Average Return	0.06%	0.07%	0.04%	0.00%	0.10%	6
	Market Independent	0.02%	0.02%	0.02%	-0.01%	0.06%	6
	Market Component	0.62	0.57	0.33	0.10	1.04	6
Jute	Average Return	6%	6%	8%	0.41%	11%	2
	Market Independent	6%	6%	8%	0.4%	12%	2
	Market Component	-4	-4	5	-8	0.04	2

		<b>Mean</b>	<b>Median</b>	<b>Standard Deviation</b>	<b>Min</b>	<b>Max</b>	<b>Count</b>
Paper and Printing	Average Return	0.38%	0.38%	0.73%	-0.14%	0.90%	2
	Market Independent	0.37%	0.37%	0.75%	-0.16%	0.89%	2
	Market Component	0.21	0.21	0.18	0.08	0.33	2
Pharmaceuticals and Chemicals	Average Return	1%	0.04%	2%	-0.4%	6%	25
	Market Independent	-61%	-0.04%	295%	-1475%	5%	25
	Market Component	937	0.49	4497	-0.22	22515	25
Services and Real estate	Average Return	0.02%	0.02%	0.06%	-0.03%	0.10%	4
	Market Independent	-0.02%	-0.02%	0.06%	-0.10%	0.05%	4
	Market Component	0.66	0.75	0.32	0.22	0.93	4
Tannery Industries	Average Return	3%	2%	3%	0.82%	7%	4
	Market Independent	3%	2%	3%	0.76%	7%	4
	Market Component	0.70	0.80	0.32	0.25	0.95	4
Telecommunication	Average Return	0.10%	0.10%	0.03%	0.08%	0.12%	2
	Market Independent	0.06%	0.06%	0.01%	0.05%	0.06%	2
	Market Component	0.72	0.72	0.33	0.49	0.96	2
<hr/>							
		<b>Mean</b>	<b>Median</b>	<b>Standard Deviation</b>	<b>Min</b>	<b>Max</b>	<b>Count</b>
Textile	Average Return	0.86%	0.07%	2%	-0.12%	11%	38
	Market Independent	0.84%	0.03%	2%	-0.15%	10%	38
	Market Component	0.50	0.62	0.79	-3	2	38
Travel and Leisure	Average Return	-0.03%	-0.02%	0.04%	-0.07%	0.00%	3
	Market Independent	-0.07%	-0.04%	0.07%	-0.15%	-0.03%	3
	Market Component	0.66	0.50	0.50	0.25	1.21	3

## *Part 5: Hospitality & Tourism*

# Demystifying Gender Bias Intensity in Service Based Organizations

Noel Criscione-Naylor and Jane Bokunewicz

Hospitality and Tourism Management Studies  
Stockton University, United States

## Abstract

Gender inequality and the value of gender diversity are widely acknowledged in the literature. Women experience organizational barriers relative to their success; yet, there are clear links between increases in representation of women in leadership roles to increases in financial results. As service based industries seek for a competitive means in a highly saturated and differentiated market, organizations should not neglect moving women to the top of their strategy focus and activities. Accordingly, this research investigated the intensity of gender bias in service based industries by functional area and examined the linkages between gender, gender bias, leadership rank, and equal opportunity measures to support organizations in using gender as a competitive strategy. This research was conducted with 138 participants and revealed gender bias as a complicated manifestation explained through the lens of Pluralistic Ignorance. Findings of this study demonstrate more women than men experienced gender bias despite both genders reporting equality in the work place. This research contributes to understanding gender bias intensity factors, with the acknowledgement of Pluralistic Ignorance to explain contrary data, to promote organizational awareness and direct efforts.

**Keywords:** gender, gender bias, gender stereotype, gender stigma, pluralistic ignorance, work environment, women, diversity, human resources

## Introduction

Gender inequality and the value of gender diversity are widely acknowledged in the literature. Despite links between women and increases in financial results, gender bias is routinely overlooked and minimized. Although there have been improvements between the wage disparity amongst men and women, the glass ceiling continues to triumph with the support of several other barriers to the success of women including gender bias and gender stereotyping, sexual harassment, the lack of mentors and role models, the lack of formal career development activities and projects, the exclusion from informal networks, the perception of leadership style, and value associated with male dominated behaviors and functional roles. One explanation for the failure to address these barriers is Pluralistic Ignorance which can lead to the perpetuation of unsupported social and workplace norms and limit reporting of such incidents (Halbesleben, 2009; Miller & Nelsen, 2002). Additionally, this social phenomenon is likely to occur when peers are gathered together, such as in the workplace, and may explain why group members often refrain from discussing their ultimate concerns with each other surrounding difficult topics (Grant, O'Neil, & Stephens, 2009; Miller & Nelson, 2002). As a result, organizations must acknowledge Pluralistic Ignorance and the broad environment's reinforcement of gender stereotyping and women's unconscious conformity to gender bias (Evans, 2011; Grant, O'Neil, & Stephens, 2009; Halbesleben, 2009; Miller & Nelson, 2002; Miller & Sisk, 2012).

As service intense organizations seek for a competitive strategy to combat a highly saturated and differentiated market as well as the growing proportion of women spending contribution, service

based industries need to focus on increasing organizational gender balance and leverage women talent. Accordingly, organizations are compelled to address the impact of gender bias and utilize their Human Resources function as a strategic entity to promote increases in organizational awareness and competitive strategies addressing gender bias and encouraging the development and recruitment of women within the industry. Organizations must support gender awareness and uncover systemic perceptions of gender performance and contribution as a condition for doing business to combat organizational, Pluralistic Ignorance (Miller & Sisk, 2012). Blayney and Blotnicky (2010) suggest that these activities must include building a diverse strategic culture in which Human Resources practitioners critically evaluate and review organizational promotion practices, reward and recognition systems offered, and developmental processes that are gender specific. Human Resources practitioners should help their organization's identify signs of diversity problems, emphasizing the importance of documenting employment decisions and helping organizational leaders to create policies that are gender neutral, offer family flexibility, and create a fair work environment regardless of gender (Miller & Sisk, 2012).

Research surrounding gender bias in the workplace exists and literature has begun to move from macro to micro views attempting to identify the manifestation of gender influenced activities in organizations in specific industry domains; more so being popular in the international market. Research has investigated and explored the relationships between women and men and the impact of gender from the perspective of leader and subordinate and the glass ceiling phenomenon. Women leadership has also been contextualized and compared to that of men in the hotel, gaming, and food and beverage segment. However, there is a significant gap in the literature that omits comparatively understanding the manifestation and impact of gender bias across traditional service based disciplines as well as examining it through the lens of Pluralistic Ignorance. Additionally, the research has not investigated this manifestation and the perceived relationship of gender bias to the organization, the leader, and equal opportunity in the workplace. The results of this study indicate a marginal relationship between perceived gender of a leader to subordinate and low acknowledgement of organizational and leader reinforcement of gender bias. However, the data offers contrary positions on the perceptions of gender bias held by men and women which perpetuates the existence and barrier of Pluralistic Ignorance.

## **Literature Review**

Diversity as a whole has been identified as a strategic asset in which the overall existence of diversity promotes opportunities for interaction with diverse peers resulting in the possibility of higher learning, problem solving, creativity, innovation, and commitment to change (Borasi & Finnigan, 2010). Coupling this value in diversity and directing attention to the documented ability of women to increase profits and advance business from unique perspectives and leadership styles needs to become the focus of Human Resource practitioners. Furthermore, organizations must build a diverse environment, realizing that this can only be accomplished when women participate in all levels of management allowing talent to come together regardless of gender differences to affect business decisions (Evans, 2011). Organizations need to develop and promote change to the damaging impact of gender stereotyping and remove this barrier of bottom line performance potential through increasing gender balance in their organization (Blayney & Blotnicky, 2010; Evans, 2011). Clear links to the increased representation of women has already demonstrated positive bottom line results supporting the belief that women drive performance and contribute to

an organization's competitive resources (Blayney & Blotnick, 2010; Evans, 2011; Miller & Sisk, 2012).

Women find themselves trapped in leadership, gender stigmas. Women leaders face higher standards than male leaders and are rewarded less. Women that exhibit traditionally valued masculine leadership behaviors such as assertiveness are perceived as competent but are not well liked while women that exhibit more feminine, stereotypical behaviors are more well liked and perceived as not having the necessary or valued leadership skills to strategically improve the performance of the organization (Evans, 2011). Organizations hold a common belief that masculine leadership characteristics, particularly those related to business acumen and influence, result in better performance while feminine styles of management are evaluated as deficient (Evans, 2011; Miller & Sisk, 2012). Although leadership characteristics and styles between men and women are marginal, women tend to have higher interpersonal behaviors and are more oriented to demonstrate collaborative and inclusive approaches to support and maintain relationships as compared to men (Blayney & Blotnick, 2010; Evans, 2011). Accordingly, these differences may have a direct impact on women as compared to men relative to experiencing gender bias.

Furthermore, women experience organizational barriers to their success including exclusion from informal networks, the lack of role models and mentors and the inability of organizations to support or offer opportunities for development (Evans, 2011). There is a significant lack of women role models as well as men that are comfortable taking on such a role with women (Miller & Sisk, 2012). As a result, women receive less mentoring and have been perceived as misunderstanding mentoring advances as sexual advances (Blayney & Blotnick, 2010; Miller & Sisk, 2012). Additionally, women rely on the organization's formal process for career development and promotion while men tend to use the informal network to support career advancement objectives (Blayney & Blotnick, 2010). This has resulted in female leaders having fewer development assignments and less mobility for career advancement opportunities. Research conducted by Blayney and Blotnick (2010), identified that developmental assignments are highly correlated to career success and women become highly disadvantaged in increasing their capability which marginalizes women to lead smaller functional areas or smaller organizations as compared to men. Accordingly, a framework needs to be put into place to emphasize internal mentoring of staff to promote and develop women professionally and as organizational leaders (Evans, 2011).

As such the authors hypothesize that:

The gender of a direct supervisor impacts equal opportunity for women. Equal opportunity is defined as being selected and participate in informal networks and activities and receiving equal pay.

In the development of an organizational strategy targeting the retention and promotion of women, there have been examples of success and the value of women leadership. These strategies have included developing a culture of retention and recruitment, increasing the number of women in all levels of roles, particularly leadership roles, recognizing women's successes, and enhancing professional development opportunities (Evans, 2011). In one example, an organization was able to significantly improve women partnerships from 31% to 88% based on their efforts. This exemplifies the need to focus on successful employment and retention tactics to overcome barriers



experienced by women and to open the door for improved bottom line performance. Unless organizations take immediate action to address gender bias, organizations will be unable to attract and retain talented women to compete in the market. Surprisingly, 71% of companies do not have programs designed to develop women (Evans, 2011).

As such the authors hypothesize that:

Gender bias intensity varies by functional area, and leadership level.

#### *Clarifying the Nature and Meaning of Pluralistic Ignorance*

In the world of Sociology, the existence of Pluralistic Ignorance has been of great interest as a result of its consequences for employees and organizations. This social phenomenon is defined as the circumstance in which individuals infer that the perceptions, beliefs, and feelings guiding their own actions differ or are opposite from those guiding the identical actions of their peers (Halbesleben, 2009; Miller & Nelson, 2002). This is likely to occur when peers are gathered together and may explain why group members often refrain from discussing their ultimate concerns with each other (Grant, O'Neil, & Stephens, 2009). This is due to group members' lack of mutual visibility, misreading of behavioral cues by members of a reference group, or taking individual's public behavior as diagnostic of their private thoughts and feelings (Grant, O'Neil, & Stephens, 2009; Miller & Nelson, 2002)

For an organization, this is of importance when considering the existence of gender bias as Pluralistic Ignorance can lead to an employee feeling deviant from his or her work group or the organization, reducing retention (Halbesleben, 2009). If employees experience Pluralistic Ignorance, the deviance they experience threatens their social identity; by hiding their true opinion and outwardly supporting the perceived group norm they can appear as though they fit in with others (Halbesleben, 2009) which may increase the longevity and existence of gender bias and discrimination in the workplace. Furthermore, Pluralistic Ignorance suggests that at group gatherings, members will often refrain from discussing their ultimate concerns (religion, politics, discrimination, harassment, etc.) because they are under the false impression that most members of their group are uncomfortable discussing such topics or group members are ignorant of a norm even when in the presence of each other (Grant, O'Neil, & Stephens, 2009). For example, in a gender based scenario of sexual harassment, this suggests that when individuals within a group laugh at sexist jokes or do not adversely respond to sexist comments or behavior, they are conveying to others implicit support for the behaviors in question. This may occur despite their personal rejection of the sexist behavior. Furthermore, the ability to observe the behavioral cues that suggest that others support the sexist behavior will increase Pluralistic Ignorance and limit reporting of such situations (Halbesleben, 2009; Miller & Nelson, 2002).

A consideration worthy in this study is to acknowledge within the bounds of Pluralistic Ignorance, if women feel that a majority of men are comfortable with the current environment, than they are more likely to accept the situation and even fail to report any experiences or concern. Additionally, fear, such as the fear of embarrassment of the individual or someone else, the fear of being materially exploited, and the fear of change or uncertainty—can produce avoidance behavior and hence contribute to Pluralistic Ignorance (Miller & Nelson, 2002). As such, individuals

inadvertently create spirals of silence and avoidance (Grant, O’Neil, & Stephens, 2009). This avoidance will ultimately prohibit gender equal opportunity and the elimination of gender bias.

As such the authors hypothesize that:

Evidence of Pluralistic Ignorance will be demonstrated by contrary respondent data and paradoxical trends.

## **Methodology**

This study used a survey as a measurement instrument with Institutional Review Board approval. A 32 question survey was informed by the literature and developed. The respondents were asked to rate the degree of their agreement or disagreement to a number of statements associated with experiencing gender bias and organizational culture in an attempt to answer the research hypotheses. Specifically, the survey utilized a five point Likert Scale with the exception of questions asking the respondents to select their level within the organization, the gender of their direct supervisor, and demographic information. The Likert Scale ratings included the following options: Strongly agree, agree, neutral/neither agree nor disagree, disagree, or strongly disagree. Only one selection was permitted per question. Limited questions allowed respondents to provide qualitative details of particular experiences or justification of a response. The survey was deployed using SurveyMonkey.com and shared via social media networks including Facebook and LinkedIn.

### *Sample*

A total of 138 individuals responded to the survey. Out of 138 respondents, 110 identified as female and 28 as male. There was an option to select “other” for gender; no respondent identified in this category. 98 respondents obtained a college education including an associate, bachelorette, masters, or terminal degree. 35 respondents earned a high school diploma and the remaining 5 respondents indicated “some college”. 138 respondents reside within the United States. Two of 138 participants identified as having a disability. To capture specific industry information, the survey requested participants to identify their specific industry type including retail, casino/gaming, food and beverage, hotel or other (requesting the respondent to specify). This information is listed in Table 1. Some examples of industry “other” types were Theme Parks, Entertainment, Destination Management, and Health Care. Additionally, the survey captured the specific functional area within the industry. A summary of this data can be found in Table 2.

**Table 1.** Respondents by Industry Area

<b>Industry</b>	<b>Count</b>	<b>Percentage</b>
Retail	6	4.38%
Casino/Gaming	56	40.88%
Food and Beverage	28	20.44%
Hotel	14	10.22%
Other	33	24.09%

**Table 2.** Respondents by Functional Area

Functional Area	Count	Percentage
Accounting	4	2.9%
Administrative	6	4.35%
Customer Service	23	16.67%
Marketing	8	5.8%
Operations	18	13.04%
Human Resources	37	26.81%
Sales	8	5.8%
Finance	6	4.35%
Legal	0	0%
IT	4	2.9%
Engineering	0	0%
Product	1	0.72%
Research and Development	0	0%
International	0	0%
Business Intelligence	1	0.72%
Manufacturing	0	0%
Public Relations	2	1.45%
Other	20	14.49%

**Findings**

A high percentage of both men and women perceived gender equality in the workplace, see Figure 1. 85.7% of men and 68.2% of women responded that their work is valued equally regardless of their gender. Similarly, 75% of men and 59.7% of women responded that they have equal access to opportunities, including promotion, regardless of their gender. Despite this perception of equality, 47.3% of women reported experiencing gender bias, defined in the survey as being treated differently than a woman or man counterpart and 50% of women reported the existence of salary gaps among men and women at the same level in their organization. This contrary data creates a paradox between perception and experience among women.

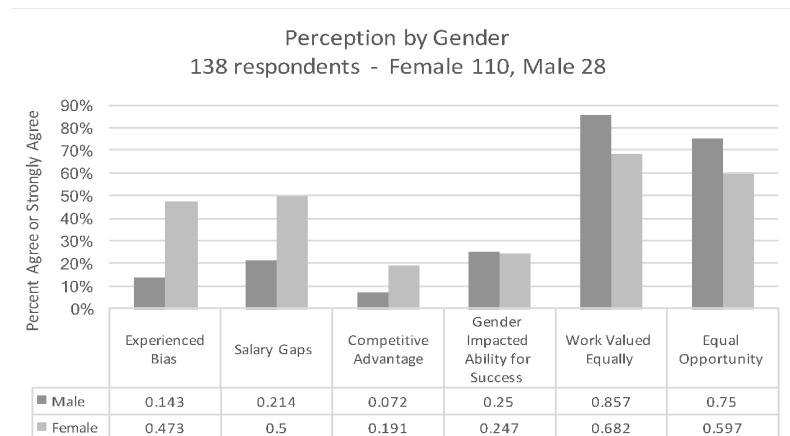
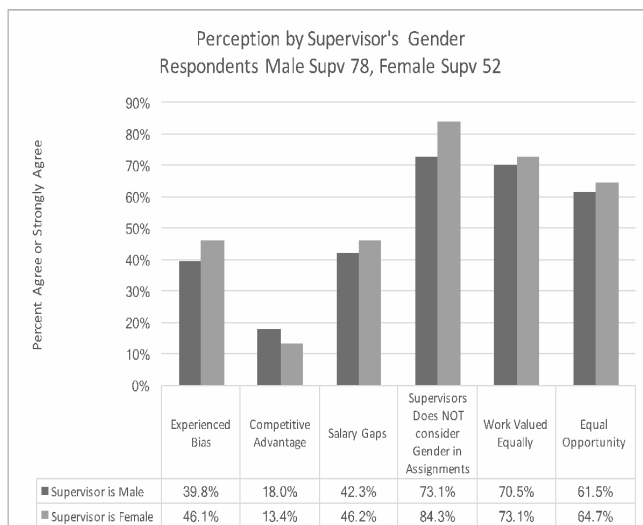

**Figure 1.** Perception by gender. This figure displays “Strongly Agree” and “Agree” data by gender

Men in the study had a more positive perception of workplace equality and reported a lesser percentage of experienced gender bias. Only 14.3% of men reported experiencing bias compared to 47.3% of women. Most men in the study did not acknowledge the existence of gender bias. Only 21.4% of men reported the existence of salary gaps between men and women. Additionally, the men in the study did not acknowledge that their gender provided a competitive advantage while a

higher percentage of women reported that their gender did provide competitive advantage (19.1% of women compared to only 7.2% of men). A higher percentage of men than women had a positive view of the work environment regarding equal opportunity and work being valued equally.

A slightly higher percentage of respondents with women leaders perceived equality in the workplace compared to those with male leaders, see Figure 2. 84.3% of respondents with female leaders indicated that their direct supervisor does not consider gender in task assignments compared to 73.1% of respondents with male leaders. The results were similar regarding the perception of equal opportunity and work being valued equally. 64.7% of respondents with female leaders compared to 61.5% of those with male leaders reported having equal opportunity and 73.1% of respondents with female leaders compared to 70.5% with male leaders reported that their work was valued equally. The percentage of respondents identifying salary gaps was similar with both male and female leaders (46.2% of respondents with female leaders and 42.3% with male leaders). A similar paradox exists in these findings between perception and experience. Despite the high percentage of perceived equality, 46.1% of respondents with female supervisors and 39.8% with male supervisors reported actually having experienced bias.



**Figure 2.** Perception by supervisor’s gender. This figure displays “Strongly Agree” and “Agree” data by supervisor’s gender

Among respondents in this study, the highest percentage of respondents who experienced bias were at the highest levels of management, see Figure 3. 51.4% of respondents at the senior management level and 46.2% at the owner/executive level reported experiencing bias compared to only 24% at the entry level. Similarly, 60% at the level of senior management and 46.2% at the owner/executive level identified salary gaps, compared to only 28% at the entry level. The perception/experience paradox is most apparent at the owner/executive level where despite a high percentage of people experiencing bias, 84.6% reported work being valued equally and 76.9% reported equal opportunity between genders.

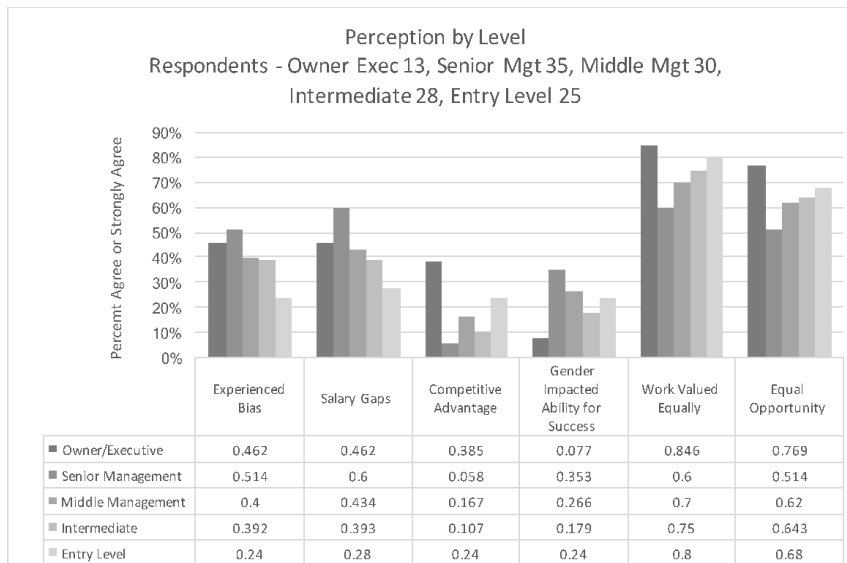

**Figure 3.** Perception by level. This figure displays “Strongly Agree” and “Agree” data by leadership level

The results of the survey revealed wide variation in respondents reporting have experienced bias by functional area, see Figure 4. The highest percentage of respondents reported that they have experienced bias was in the Marketing and Operations areas at 62.5% and 55.5% respectively. The Customer Service area had the lowest percent reported that they have experienced bias at 30.4%. 66% of respondents in the Finance area identified salary gaps compared to only 25% in Accounting, traditionally dominated areas by men.

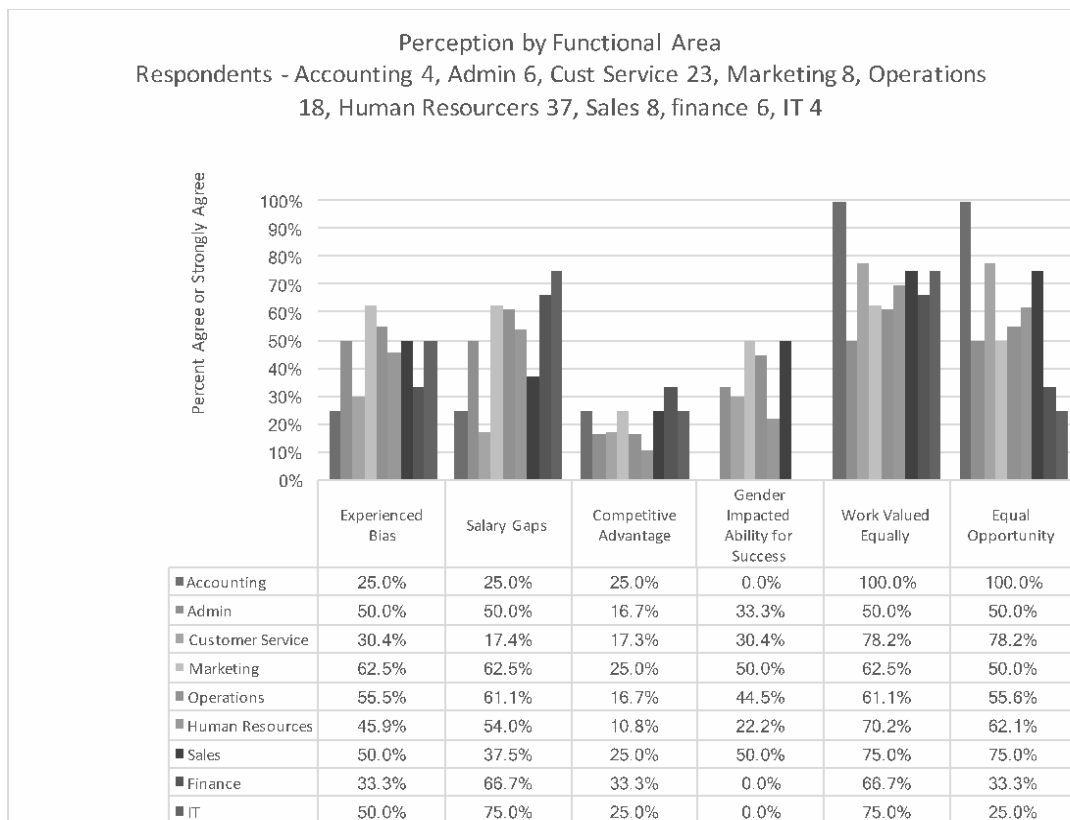

**Figure 4.** Perception by functional area. This figure displays “Strongly Agree” and “Agree” data by functional area

More men than women in the study indicated a willingness to participate in activities, see Figure 5. A high percentage of men and women, 92.8% and 88.2% respectively, said they would participate in activities regardless of the gender of their peers. Only 65.4% of women compared to 85.7% of men said they would participate in activities lead by men. A slightly higher percentage, 69.8%, of women said they would participate in activities lead by women however this is still lower than the 89.3% of men responded that they would participate.

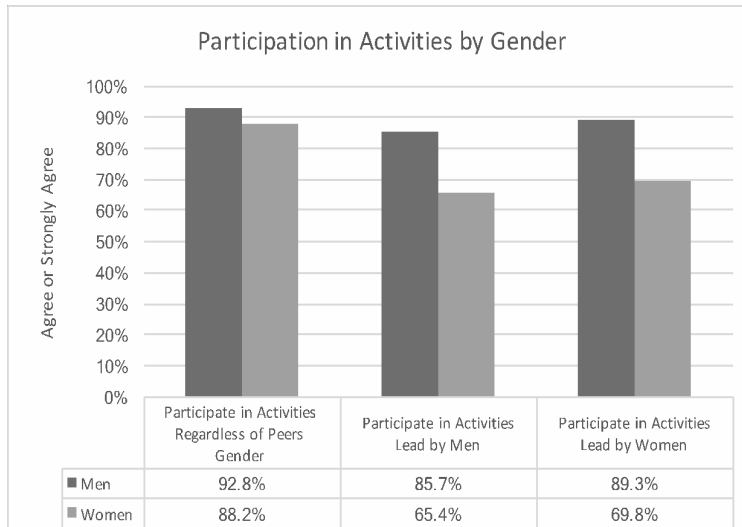

**Figure 5.** Participation in activities. This figure displays “Strongly Agree” and “Agree” data by participation in activities by gender

## Discussion and Conclusion

It is known that women experience barriers in the workplace relative to gender. The degree and significance varies; however, common themes include lack of access to projects, value of work, salary, and after work activities have been identified as top barriers to success. Additionally, with the acknowledgement and lens of Pluralistic Ignorance, an additional and intangible barrier presents itself in the workplace. Accordingly, the purpose of this discussion is to provide the study’s data in support of answering the research hypothesizes and to reconcile the discrepancies between the reported occurrences and reporting of gender bias related variables. Pluralistic Ignorance is used to provide an explanation for contrary responses and paradoxal trends that emerged in the data.

In support of research hypothesis one, the gender of a direct supervisor impacts equal opportunity for women, it is perceived that the gender of an individual’s direct supervisor does not have a significant effect on equality opportunity. Men and women both reported equality in equal opportunity related questions and reported equal access to opportunities, including promotion, regardless of their gender. Despite this response data, nearly half of all women respondents reported experiencing gender bias, defined in the survey as being treated differently than a woman or man counterpart. There is a clear gap in the perception of respondents and their report of having experienced gender bias. Accordingly, respondent data did not identify or recognize the root of gender bias experiences. Based on this paradoxal reporting, gender bias is merely acknowledged as existing and lacks substantial evidence of the source of continued discrimination.

In support of hypothesis three, evidence of Pluralistic Ignorance will be demonstrated by contrary respondent data and paradoxical trends, patterns in the data may be directly linked to group members' lack of mutual visibility, misreading of behavioral cues by members of a reference group, or taking individual's public behavior as diagnostic of their private thoughts and feelings as supported by the literature (Grant, O'Neil, & Stephens, 2009; Miller & Nelson, 2002). This is again supported in the example of men and women respondents identifying similar salary gaps based on gender of their leader; yet, looking at the data by gender, women are significantly more likely to identify gaps while men are highly unlikely to report any disparity in wages.

Reporting in this research study is similar to Pluralistic Ignorance studies surrounding sexual harassment in which individuals convey to others implicit support for behaviors, actions, and the organization culture in question, ultimately limit reporting of such situations or creating avoidance of the topic all together (Halbesleben, 2009; Miller & Nelson, 2002). This avoidance is of great concern for service based industries as it will ultimately prohibit gender equal opportunity and add an additional barrier for women in the workplace. Furthermore, it will have a negative impact on retention, raises in women in leadership, and using women as competitive human capital.

In addressing hypothesis two, gender bias intensity varies by functional area and leadership level, there is variation in gender bias intensity by functional area. Traditionally male dominated areas, such as finance and accounting, demonstrate the highest reported gender bias areas. Accordingly, traditionally female dominated areas like customer service received the lowest reported gender bias experiences. The identification of intensity by functional area supports the need to inform and educate the existing workforce and address organization's culture and norms that may be the result or effect of Pluralistic Ignorance. As such and referencing research hypothesis one, although gender may not have a significant impact on equal opportunity, the functional area in which an individual pursues may, along with the gender of a direct supervisor and willingness to participate in activities.

The lack of acknowledgement of the existence of gender bias by men and by the highest levels of management is concerning. More men than women are in higher level management positions. For example, in this study 78 respondents reported having a male supervisor compared to 52 who reported having a female supervisor despite women comprising the majority of respondents. If individuals in higher leader levels with authority and power to positively impact equality in the workplace do not see this inequality, this will impede efforts to change it. As such, the data supports research hypothesis two not only in gender bias intensity differences by functional area but includes by leadership level. Accordingly, the higher the leadership level, the more likely an individual is likely to experience gender bias, particularly women.

Although there are limitations of this study including sample size, geographic location of respondents, and further evaluation of additional variables such as leadership behavior and organizational structure, this study contributes to existing literature by clarifying linkages between gender, gender bias, leadership rank, and specific industry functions by exposing the dynamism and relationship among these considerations as well as the impact of Pluralistic Ignorance. As a result, findings of this study improves awareness in service intense organizations and promotes organization's ability to more effectively direct efforts leading to improved performance and competitive advantage with equal opportunity and gender diversity. This research offers Human

Resource practitioners a starting point to review organizational culture and norms to prepare to evaluate and generate awareness to address gender bias and Pluralistic Ignorance in the workplace.

## References

- Blayney, C. & Blotnicky, K. (2010). The Impact of Gender on Career Paths and Management Capability in the Hotel Industry in Canada. *Journal Of Human Resources In Hospitality & Tourism*, 9(3), 233-255. doi:10.1080/15332845.2010.487014
- Borasi, R., & Finnigan, K. (2010). Entrepreneurial attitudes and behaviors that can help prepare successful change-agents in education. *New Educator*. 6(1), 1-29.
- Evans, D. (2011). Room at the top: Advancement and equity for women in the business world. *National Civic Review*, 100(2), 62-64. doi:10.1002/ncr.20061
- Grant, D., O'Neil, K., & Stephens, L. (2009). PLURALISTIC IGNORANCE AMONG ASSEMBLED PEERS. *Sociological Perspectives*, 52(1), 59-79.
- Halbesleben, J. B. (2009). The Role of Pluralistic Ignorance in the Reporting of Sexual Harassment. *Basic & Applied Social Psychology*, 31(3), 210-217. doi:10.1080/01973530903058284
- Miller, D. T., & Nelson, L. D. (2002). Seeing Approach Motivation in the Avoidance Behavior of Others: Implications for an Understanding of Pluralistic Ignorance. *Journal Of Personality & Social Psychology*, 83(5), 1066-1075. doi:10.1037//0022-3514.83.5.1066
- Miller, G. L., & Sisk, F. A. (2012). Business Education and gender bias at the 'C-Level'. *Administrative Issues Journal: Education, Practice & Research*, 2(1), 16-25. doi:10.5929/2011.2.1.10



# Self-Efficacy and Job Outcomes Among Tour Guides

Jennifer C. H. Min

Department of International Business  
Ming Chuan University, Taipei, Taiwan

## Abstract

Self-efficacy refers to individuals' levels of confidence in their ability to execute a course of action or achieve specific performance outcomes. Hence, it remains as an integral element in the relationship between ability and performance. This study therefore uses self-evaluation to achieve a better understanding of how self-efficacy relates to job outcomes (job performance, job satisfaction and well-being) among tour guides who significantly influence tourists' impressions of a destination. The Structural Equation Modelling (SEM) is adopted to examine significant relationships between these factors. The results found that self-efficacy is positively associated with these job outcome variables and that job performance was positively related to job satisfaction and well-being. Further, this positive relationship was indicated between job satisfaction and well-being. These results have practical implications for the tour guide population, as they can provide a roadmap for developing self-efficacy interventions which can improve their job performance/satisfaction as well as psychological happiness and well-being.

**Keywords:** self-efficacy, tourism, tour guide, job outcome

## Introduction

The importance of self-efficacy has been the topic of increasing research in the behavior literature (Pan et al., 2011; Chen et al., 2015). In the late 1970s, several researchers turned their attention to assessing self-beliefs in a more task-specific way. Among these efforts, one of the most important focused on self-efficacy (Ramchunder & Martins, 2014). Self-efficacy is a concept developed by Bandura from his social learning theory in 1977, and he defined it as people's beliefs, expectations and self-confidence in their ability to perform tasks to a certain standard. However, self-efficacy does not refer to a person's actual skills, but rather one's beliefs about one's potential accomplishments. The strength of self-efficacy influences people's efforts to overcome obstacles and solve any variety of challenging situations which is the chief construct linking ability to performance. People with high self-efficacy have greater confidence in their ability to mobilize the resources necessary to meet the demands of a given situation and thus successfully complete the task at hand (Wood & Bandura, 1989, p. 408), resulting in greater confidence in successfully completing a task. Those with lower self-efficacy, on the other hand, are associated with lower confidence to complete the task, leading to negative attitudes or escape while facing the difficulties (Bandura, 1977). Numerous studies have demonstrated the positive links between self-efficacy and different behavioral outcomes, such as in educational (e.g. Chesnut & Cullen, 2014), environmentally responsible behavior (e.g. Taberero & Hernández, 2011), and organizational settings (e.g. Khedhaouria, Gurău, & Torrès, 2015).

Job outcomes, such as employees' job performance, job satisfaction, and well-being, have always been a major concern of managers and researchers in the management field (Gountas et al., 2014). Bandura (1977) and Wood and Bandura (1989) indicated that self-efficacy's ability to direct

interests, motivation and perseverance make it the most effective predictor of performance. Beliefs about efficacy have an important influence on employees' behavior and attitude, and efforts to strengthen self-efficacy accordingly have a positive effect on work engagement, job satisfaction and job performance. The level of self-efficacy can thus be seen as a predictor of the effort invested in a particular task or activity, and this will turn clearly influence the employees' job-related factors (McNatt & Judge, 2008). For example, those with higher self-efficacy will be more likely to have high job performance (Judge et al., 2007) and higher job satisfaction and institutional commitment (Aliyev & Tunc, 2015). In addition, they are better at coping with stress (Lubbers et al., 2005), which results in enhancement of achievements and psychological happiness and well-being (Adeyemo, 2008; Salami, 2010).

Some studies suggest that self-efficacy is a learned human characteristic (Vuk et al., 2015). It has additionally been stated that once this skill is acquired, it can be improved effectively and allow individuals to confidently perform required duties. More specifically, when someone encounters a challenge, they may view an obstacle from a more positive stance while retaining a sense of tranquillity. It is interesting to note that there remains scant research regarding the association between self-efficacy and job outcomes of tour guide professionals, who play the front-line service providers in the tourism industry. Additionally, tour guides' performance greatly influences tourists' perceptions of the host destination, and they are thus instrumental in the success or failure of a tour experience (Min, 2011, 2012, 2014, 2016). Therefore, this study examines these relationships using self-evaluation, with the goal of achieving a better understanding of how these factors (self-efficacy, job performance, job satisfaction and wellbeing) interact among guide groups. Structural equation modelling (SEM), a type of multivariate analysis, is adopted to determine if there exists significant relationships among the previously mentioned factors. Such an investigation provides the simultaneous estimation of multiple regressions, ultimately confirming the theoretically built model.

## **Literature Review**

Self-efficacy refers to one's belief in one's ability to successfully execute a certain course of behavior or cope with environmental demands. In order to understand how self-efficacy relates to employee job-related outcomes and well-being, it is important to understand the psychological mechanisms that may explain this relationship. Self-efficacy is linked to task-specific capability, and individuals with high self-efficacy are therefore able to set high goals, put forth greater effort, and perform more effectively. Wood and Bandura (1989) found that people who have confidence in their competencies have a greater likelihood of initiating actions and persisting in their efforts. In occupational terms, employees with competence and confidence in their skills will be more able to achieve their goals and produce successful outcomes in areas such as job performance, job satisfaction and increased well being (Karatepe et al., 2007). There is empirical evidence to support the premise that self-efficacy beliefs play a major role in job, and psychological and physical health outcomes. For example, Hartline and Ferrell (1996) indicated that self-efficacy was positively related to hotel customers' perceptions of service quality (frontline employee performance). Brown et al. (1998) assessed the self-set goal levels and sales performance and found that self-efficacy had strong direct and indirect links on sales performance. The same positive association has been demonstrated in different organizational and academic settings, such as for two different samples of real estate sales agents and billboard advertising salespeople by Wang and Netemeyer (2002), undergraduate students by Prussia et al. (1998), scientists' by Randhawa (2007), and high

school students' music performance by Hewitt (2015). The moderating effect of self-efficacy has also been examined by Pan et al. (2011), who found that self-efficacy moderates the mediated effects of supervisory mentoring on job performance and career satisfaction through personal learning such that the mediated effect on job performance is stronger when employees have higher self-efficacy through path analytic tests. Similar findings of Alessandri et al. (2015) showed that when work self-efficacy beliefs are high or medium, there exists a residual effect of positive orientation on job performance.

In light of the weight of the empirical evidence, the following hypothesis is proposed:

Hypothesis 1: Tour guides' self-efficacy will be positively related to job performance.

Some researchers observed a positive relationship between self-efficacy and job satisfaction. For example, Hartline and Ferrell (1996) found that feelings related to individual efficacy, such as competence and confidence, make a job more enjoyable. Similarly, Judge and Bone (2001) found that those with high self-efficacy will be more likely to receive benefits at their work, which in turn leads to greater job satisfaction. A study by Caprara et al. (2006) investigated over 2,000 teachers in 75 Italian junior high schools and found that teachers' self-efficacy beliefs were determinants of job satisfaction and students' academic achievement. Karatepe et al. (2006) conducted a path analysis, which demonstrated the direct effect of self-efficacy on job satisfaction in the sample of frontline employees in hotels. A significant positive correlation was found in some studies using different sampling, such as employees in a health care firm (O'Neill & Mone, 1998), frontline bank employees (Chebat & Kollias, 2000), nurses (Zellars et al., 2001), tour guides (Idrus et al., 2015) and psychological counselors (Aliyev & Tunc, 2015). Self-efficacy is thus a useful mechanism for explaining individual behavior, as it provides a foundation for motivation, well being and personal accomplishment (Noor et al., 2012; Niu, 2010). For instance, Nielsen and Munir (2009) found that self-efficacy can positively predict one's likelihood of being in a positive state of mind. Nielsen et al. (2009) argue that employees' perceived self-efficacy in coping with work demands is linked to increased job satisfaction and well-being. Evidence of this relationship was also reported by Duggleby et al. (2009) and Salami (2010).

Therefore, based on the empirical evidence outlined above, the following hypotheses are proposed:

Hypothesis 2: Tour guides' self-efficacy will be positively related to job satisfaction.

Hypothesis 3: Tour guides' self-efficacy will be positively related to well-being.

Previous studies regarding job satisfaction and job performance relationships have examined this issue in great depth. Netemeyer, Brashear-Alejandro and Boles (2004) focused on sales representatives from the United States, Puerto Rico and Romania and found that high levels of job performance are linked to a rise in job satisfaction. Karatepe et al. (2007) supported these findings through their empirical study of hotel employees. Researchers have additionally determined a relationship that directly connects job satisfaction and well-being. This link was stated by Begat, Ellefsen and Severinsson (2005) who concluded that nurses' well-being was reflected through their work satisfaction. In addition, the association between job performance and employees' well-being has been examined in the management field. Using emotional exhaustion as an indicator of

affective well-being, Taris (2006) found the average correlation between emotional exhaustion and well-being was  $-.22$ , presenting a moderate relationship.

Given the above arguments, the following hypotheses are proposed:

Hypothesis 4: Tour guides' job performance will be positively related to job satisfaction.

Hypothesis 5: Tour guides' well-being will be positively related to job performance.

Hypothesis 6: Tour guides' job satisfaction will be positively related to well-being.

## **Methodology**

### *Instruments and Procedure*

The present study involves the collection and analysis of quantitative data in order to examine the relationships among self-efficacy and job outcomes (such as job performance, job satisfaction and wellbeing). Four self-report instruments were used to assess the associations of these four variables. All items are measured using the closed ended questionnaires designed to obtain responses on a five-point Likert scale.

General Self-efficacy Scale (GSES) includes 10 items (e.g. "I can always manage to solve difficult problems if I try hard enough" "I can usually handle whatever comes my way"). It was developed by Schwarzer and Jerusalem in 1995. The tour guides were asked to evaluate how capable they felt in carrying out the described action or behavior, and a higher score indicates a higher level of self-efficacy.

Chinese Job Performance Scale developed by Lee et al. (1999) was used to assess job performance among tour guides in the current study. The scale embraces efficiency (4 items), effectiveness (4 items), and quality (3 items), and has been adapted to the Chinese population with good reliability and validity .

Short-form of MSQ (Minnesota Satisfaction Questionnaire) developed by Weiss et al. (1967) measures the tour guides' job satisfaction, which is widely adopted and provides a reliable scale. The 20-item scale includes three dimensions: intrinsic (12 items), extrinsic (6 items), and general satisfaction (2 items). Tour guides were asked to indicate how they feel about different aspects of their present job, such as "being able to keep busy all the time", "the chance to do things for other people" etc. Prior tourism research on the MSQ has successfully demonstrated that the scale's psychometric properties are acceptable (eg. Yeh, 2013; Gunlu et al., 2010).

Chinese Happiness Inventory (CHI) was adopted to assess perceived level of happiness among tour guides. These 10 items' scores represent the respondents' feelings of subjective well-being, and a high score indicated high levels of well-being (Lu, 2006).

In preparation for conducting the current study, it was submitted for review by the Institutional Review Board (IRB), who certified that it meets their requirements. According to the Monthly statistical report (Tourism Bureau, 2018), there is a total of 39, 782 licensed tour guides working in Taiwan, majority of whom are a freelance basis. The Taiwan Tourist Guide Association

therefore provided the assistance on survey distribution, because they would benefit from the findings. A total of 500 surveys were distributed, and the profiles of the respondents are shown in Table 1. The usable cases consisted of 234 males (56.7%) and 179 females (43.3%), which is an accurate reflection of the gender proportions of Taiwan's tour guide population (59% : 41%) (Tourism Bureau, 2018). The majority of respondents were over 40 years old (81.6%), and more than half of the respondents (70.7%) were university graduates (47.9% undergraduate; 22.8% postgraduate). Regarding marital status, 63.9% were married, 32.7% were single, and 3.4% were divorced or widowed. Most (62.3%) respondents had worked as a tour guide for less than 10 years. The most common language used was Mandarin Chinese (70.7%), while fifty-five tour guides (13.3%) indicated that they used more than one language.

**Table 1.** Demographic Profile of Respondents

	Frequency ( <i>N</i> =413)	%
<i>Gender</i>		
male	234	56.7
female	179	43.3
<i>Age group</i>		
20~29 years	28	6.8
30~39 years	48	11.6
40~49 years	99	24.0
50~59 years	171	41.4
60 years and above	67	16.2
<i>Education</i>		
vocational school	33	8.0
college	88	21.3
university	198	47.9
postgraduate	94	22.8
<i>Marital status</i>		
single	264	63.9
married	135	32.7
divorced or widowed	14	3.4
<i>Language</i>		
Chinese	293	70.7
English	39	9.4
Japanese	13	3.1
others	14	3.4
more than one language	55	13.3
<i>Work experience</i>		
under 1 years	71	17.2
1-9 years	269	65.1
10-19 years	51	12.3
20-29 years	13	3.1
30-39 years	6	1.5
40 years above	3	0.7

## Empirical Results

The collected data were analysed using SPSS 20.0 and SmartPLS 3.2.4 for Windows. In terms of intercorrelations, there were significant correlations amongst all the dimensions. Table 2 also revealed, as expected, that tour guides' tour dimensions of self-efficacy were positively and significantly related to job outcomes (such as job performance, job satisfaction and wellbeing). In addition, there were significant correlations amongst all the scales and subscales of job outcomes tested by the Pearson Correlation. The Cronbach alphas, ranging from 0.803 to 0.925, indicate that internal consistency exists.

**Table 2.** Pearson Correlation, Means, Standard Deviations, and Cronbach Alpha Reliability among Model Variables

	SE	JP	JP1	JP2	JP3	JS	JS1	JS2	WB	Cronbach's Alpha
SE	1.000									0.911
JP	.690***	1.000								0.925
JP1	.618***	.899***	1.000							0.845
JP2	.645***	.911***	.750***	1.000						0.803
JP3	.614***	.909***	.710***	.739***	1.000					0.847
JS	.481***	.559***	.534***	.476***	.510***	1.000				0.921
JS1	.403***	.482***	.455***	.426***	.432***	.933***	1.000			0.901
JS2	.493***	.569***	.543***	.474***	.529***	.943***	.778***	1.000		0.818
WB	.513***	.556***	.488***	.493***	.528***	.549***	.477***	.536***	1.000	0.892
Mean	3.985	4.122	4.113	4.037	4.198	3.738	3.520	3.911	4.008	
SD	0.496	0.472	0.536	0.542	0.491	0.582	0.681	0.572	0.552	

Note: SE, self-efficacy; JP, job performance; JE, job efficiency; JE1, job effectiveness; JQ, job quality; JS, Job Satisfaction; EJS; extrinsic satisfaction; IJS, intrinsic satisfaction; WB, wellbeing  
 \*p<.05, \*\*p<.01, \*\*\*p<.001

*Assessment of Measurement Model and Hypotheses Testing*

The indicators of goodness of fit are comparative fit index (CFI) = 0.960, Non-Normed Fit Index (NNFI) = 0.958, Incremental Fit Index (IFI) = 0.960, (acceptably  $\geq 0.90$ ) and root mean square error of approximation (RMSEA) = 0.0732 (acceptably  $\leq 0.08$ ). Based on the results, all of the model-fit indices exceeded the common acceptance levels, thus demonstrating that the hypothesized model fits the empirical data well. Table 3 shows that the CR (construct reliability), the shared variance among a set of observed variables measuring an underlying construct, was above the suggested criterion of 0.70. It demonstrates high reliability for all the constructs. The average variance extracted (AVE) used to assess convergent validity represents the overall amount of variance in the indicators captured by the latent construct. Satisfactory evidence for convergent validity was provided because each AVE value exceeded the threshold values of 0.5.

**Table 3.** Measurement Model Results

Construct	Variables	Standardised loadings	Item reliability	t-Value	SE	CR	AVE
SE	SE	1.000	0.939	n/a	n/a	1.000	1.000
JP	JE	0.905	0.808	74.480***	0.012	0.893	0.823
	JE1	0.915	0.783	91.389***	0.010		
	JQ	0.902	0.837	92.350***	0.010		
JS	EJS	0.934	0.868	103.273***	0.009	0.875	0.889
	IJS	0.951	0.748	99.022***	0.010		
WB	WB	1.000	0.794	n/a	n/a	1.000	1.000

\* p < 0.05, \*\* p < 0.01, \*\*\* p < 0.001

a Construct reliability =  $(\sum \text{Standardized loadings})^2 / [(\sum \text{Standardized loadings})^2 + \sum \epsilon_j]$ .

b Average variance extracted (AVE) =  $\sum (\text{Standardized loadings})^2 / [\sum (\text{standardized loadings})^2 + \sum \epsilon_j]$ , where  $\epsilon_j$  is the measurement error.

*Assessment of Structural Model and Hypotheses Testing*

The present study tested eight hypotheses through SEM in the developed research model. The structural paths were estimated to examine the hypothesised relationships among independent and dependent variables, graphically displayed as Figure 1. The observed variables are enclosed in squares, and the latent variables are enclosed in circles. A one-way path between constructs is indicative of a hypothesised direct effect of one construct on another.

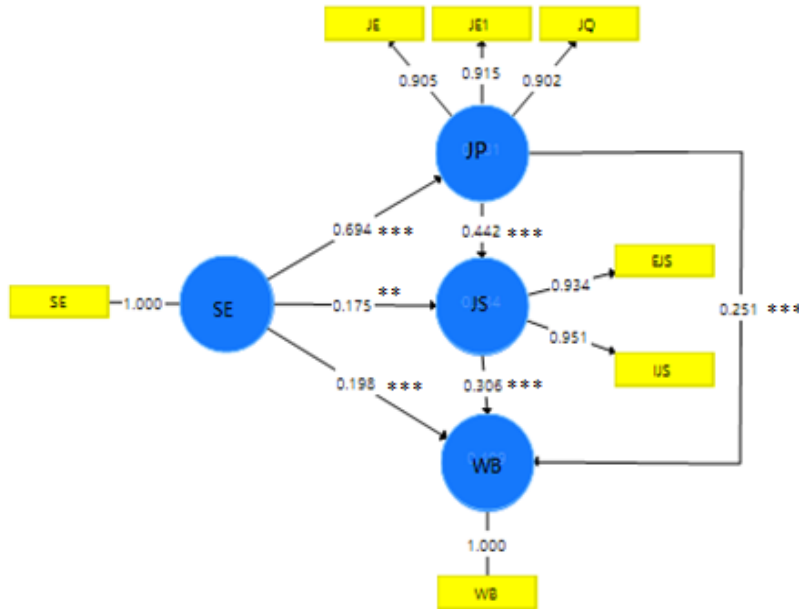

\*\*\*p<.001

**Figure 1.** Results of structural equation model

Within the overall model, the estimates of the structural coefficients provide the basis for testing the proposed hypotheses. Table 4 reports the results of the hypothesis tests, and all paths in the model were significant. The findings fully supported the hypotheses 1-6, with a significant ( $p<0.001$ ), and these findings are consistent with the results in previous studies. In addition, the total effect is therefore recognized based on the structural coefficients.

**Table 4.** Summary of Hypothesis Testing Results

Path	Structural coefficients	SE	t-Value	Test result
SE → JP	0.694	0.028	24.648***	Support
SE → JS	0.175	0.069	2.527*	Support
SE → WB	0.198	0.072	2.759**	Support
JP → JS	0.442	0.066	6.672***	Support
JP → WB	0.251	0.070	3.576***	Support
JS → WB	0.306	0.052	5.914***	Support

\*  $p < 0.05$ , \*\*  $p < 0.01$ , \*\*\*  $p < 0.001$

Previous empirical research has provided a direct relationship between self-efficacy and three work variables, and associations among work outcomes. Therefore, for the purpose of ruling out

the possibility of such direct effects, the mediating effects of job performance and job satisfaction was further assessed by analyzing the indirect effects of self-efficacy-job satisfaction and wellbeing, as well as self-efficacy - well-being. The results showed that the mediating effect of job performance between self-efficacy and job satisfaction reaches 0.307 of the multiplication of two coefficients ( $0.694 \times 0.442 = 0.307$ ), which is more than the direct impact of self-efficacy on job satisfaction (0.175). These findings indicate that job performance does not have a partial mediating role in the relationship between self-efficacy and job satisfaction. The partial mediating role of well-being was also examined, and the results indicated. In addition, job satisfaction plays a partial mediating role in the relationship between self-efficacy and well-being. Table 5 summarises the measured effects of all relationships.

**Table 5.** Direct, Indirect and Total Effects of Relationships

Path	Direct effect	Indirect effect	Total effect
SE → JP	0.694		0.694
SE → JS	0.175	0.307	0.482
SE → WB	0.198	0.321	0.510
JP → JS	0.442		0.442
JP → WB	0.251	0.135	0.386
JS → WB	0.306		0.306

## Conclusions

Self-efficacy refers to individuals' levels of confidence in their ability to execute a course of action or achieve specific performance outcomes. People who have high self-efficacy will believe in their ability to perform a specific task, and this results in greater perseverance, better flexibility at coping with challenges, and an enhanced feeling of self-accomplishment. Conversely, people with low self-efficacy will have less confidence in their ability to perform a specific task, which results in them giving up prematurely and thus failing at higher rates. While there is considerable evidence of the importance of self-efficacy and its relationships with various work related factors have been acknowledged in different organizational settings, there is currently a lack of research in the tourism literature examining its consequences among the tour guide population, who significantly influence tourists' impressions of a destination (Min, 2011, 2012, 2014, 2016).

The obtained results indicated that self-efficacy and the job outcomes were positively correlated; tour guides with higher self-efficacy levels reported having more job performance, job satisfaction and wellbeing. The results are consistent with previous research showing these relationships for other settings. As stated previously, the research has identified that the competencies of self-efficacy can be learned and enhanced through proper training techniques. Such training in turn allows an individual to become more confident in successfully completing tasks when faced with challenging situations, resulting in better work related outcomes. The results of this study can therefore lead to the planning of interventions and training initiatives for the purpose of further developing necessary skills to improve the abilities of efficacy, such as instruction, counseling, positive thinking exercises or practicing of new behavior to increase the abilities of self-efficiency. In practice, this can help tour guides to deal with stress and enhance their work outcomes. In addition, the findings of this study can facilitate the planning and execution of more successful



recruitment or on-the-job practices, which should result in higher levels of productivity and a happier and healthier workforce.

Regarding the limitation and avenue for future research, most of the participants in this study were junior tour guides, with less than 10 years' experience. Sampling extending to guides with different levels of experience will be conducted for future study in order to yield more objective research results.

## References

- Adeyemo, D.A. (2008). Demographic characteristics and emotional intelligence among workers in some selected organizations in Oyo state, Nigeria. *The Journal of business Perspective*, 13(1), 43-48.
- Aliyev, R., & Tunc, E. (2015). Self-efficacy in counseling: The role of organizational psychological capital, job satisfaction, and burnout. *Procedia Social and Behavioral Sciences*, 190, 97-105.
- Bandura, A. (1977). Self-efficacy: Toward a unifying theory of behavioral change. *Psychological Review*, 84(2), 191-215.
- Begat, I., Ellefsen, B., & Severinsson, E. (2005). Nurses' satisfaction with their work environment and the outcomes of clinical nursing supervision on nurses' experiences of well-being- A Norwegian study. *Journal of Nursing Management*, 13(3), 221-230.
- Brown, S., Cron, W.L., & Slocum, J.W., Jr. (1998). Effects of trait competitiveness and perceived intraorganizational competition on salesperson goal setting and performance. *Journal of Marketing*, 62(4), 88-98.
- Caprara, G.V., Barbaranelli, C., & Steca, P. (2006). Teachers' self-efficacy beliefs as determinants of job satisfaction and students' academic achievement: A study at the school level. *Journal of School Psychology*, 44(6), 473-490.
- Chen, S.C., Raab, C., & Tanford, S. (2015). Antecedents of mandatory customer participation in service encounters: An empirical study. *International Journal of Hospitality Management*, 46(1), 65-75.
- Chebat, J., & Kollias, P. (2000). The impact of empowerment on customer contact employees' roles in service organizations. *Journal of Service Research*, 3(1), 66-81.
- Chesnut, S.R., & Cullen, T.A. (2014). Effects of self-efficacy, emotional intelligence, and perceptions of future work environment on preservice teacher commitment. *The Teacher Educator*, 49(2), 116-132.
- Duggleby, W., Cooper, D., & Penz, K. (2009). Hope, self-efficacy, spiritual well-being and job satisfaction. *Journal of Advanced Nursing*, 65(11), 2376-2384.
- Gountas, S., Gountas, J., Soutar, G., & Mavondo, F. (2014). Delivering good service : Personal resources, job satisfaction and nurses' 'customer' (patient) orientation. *Journal of Advanced Nursing*, 70(7), 1553-1563.
- Gunlu, E., Aksarayli, M., & Percin, N. S. (2010). Job satisfaction and organizational commitment of hotel managers in Turkey. *International Journal of Contemporary Hospitality Management*, 22(5), 693-717.
- Hartline, M.D., & Ferrell, O.C. (1996). The management of customer-contact service employees: An empirical investigation. *Journal of Marketing*, 60(4), 52-70.
- Hewitt, M. (2015). Self-efficacy, self-evaluation, and music performance of secondary-level band students. *Journal of Research in Music Education*, 63(3), 298-313.
- Idrus, S., Alhabji, T., Al Musadieq, M., & Utami, H. (2015). The effect of psychological empowerment on self-efficacy, burnout, emotional intelligence, job satisfaction, and individual performance. *European Journal of Business and Management*, 7(8), 139-148.
- Judge, T.A., & Bono, J.E. (2001). Relationship of core self-evaluations traits—self-esteem, generalized self-efficacy, locus of control, and emotional stability—with job satisfaction and job performance: A meta-analysis. *Journal of Applied Psychology*, 86(1), 80-92.
- Judge, T.A., Jackson, C., Shaw, J., Scott, B., & Rich, B. (2007). Self-efficacy and workrelated performance: The integral role of individual differences. *Journal of Applied Psychology*, 92(1), 107-127.
- Karatepe, O.M., Arasli, H., & Khan, A. (2007). The impact of self-efficacy on job outcomes of hote employees: Evidence from northern Cyprus. *International Journal of Hospitality & Tourism Administration*, 8(4), 23-46.

- Karatepe, O.M., Uludag, O., Menevis, I., Hadzimehmedagic, L., & Baddar, L. (2006). The effects of selected individual characteristics on frontline employee performance and job satisfaction. *Tourism Management*, 27(4), 547-560.
- Khedhaouria, A., Gurău, C., & Torrès, O. (2015). Creativity, self-efficacy, and small-firm performance: The mediating role of entrepreneurial orientation. *Small Business Economics*, 44(3), 485-504.
- Lee, Y. D., Lain, J. W., & Chen, C. Y. (1999). A study on the measurement of productivity for white-collar employees: a case of electronic industry in Taiwan. *The Chinese Military Academy Journal*, 14(1), 345-361.
- Lu, L. (2006). Cultural Fit: Individual and societal discrepancies in values, beliefs, and subjective well-being. *The Journal of Social Psychology*, 146(2), 203-221.
- Lubbers, R., Loughlin, C., & Zweig, D. (2005). Young workers' job self-efficacy and affect: Pathways to health and performance. *Journal of Vocational Behavior*, 67(2), 199-214.
- Lucas, R. E. & Diener, E. (2002). The happy worker: Hypotheses about the role of positive affect in worker productivity. In M. R. Barrick & A. M. Ryan (Eds.), *Personality and work: Reconsidering the role of personality in organizations* (pp. 30–59). San Francisco: Jossey-Bass.
- McNatt, D.B., & Judge, T. A. (2008). Self-efficacy intervention, job attitudes, and turnover: A field experiment with employees in role transition. *Human Relations*, 61, 783-810.
- Min, J. (2011). Tour guides and emotional intelligence. *Annals of Tourism Research*, 38(1), 322-325.
- Min, J. (2012). A short-form measure for assessment of emotional intelligence for tour guides: Development and evaluation. *Tourism Management*, 33(1), 155-167.
- Min, J. (2014). The relationships between emotional intelligence, job stress, and quality of life among tour guides. *Asia Pacific Journal of Tourism Research*. 19(10), 1170-1190.
- Min, J. (2016). Guiding the guides: Developing indicators of tour guides' service quality. *Total Quality Management & Business Excellence*, 27(9-10), 1043-1062.
- Netemeyer, R. G., Brashear-Alejandro, T. & Boles, J.S, (2004). A cross-national model of job-related outcomes of work role and family role variables: A retail sales context. *Journal of the Academy of Marketing Science*, 32 (1), 49-60.
- Nielsen, K., & Munir, F. (2009). How do transformational leaders influence followers' affective well-being? Exploring the mediating role of self-efficacy. *Work & Stress*, 23(4), 313-329.
- Nielsen, K., Yarker, J., Randall, R., & Munir, F. (2009). The mediating effects of team and self-efficacy on the relationship between transformational leadership, and job satisfaction and psychological well-being in healthcare professionals: A cross-sectional questionnaire survey. *International Journal of Nursing Studies*, 46(9), 1236-1244.
- Niu, H.J. (2010). Investigating the effects of self-efficacy on food service industry employees' career commitment. *International Journal of Hospitality Management*, 29(4), 743-750.
- Noor, N. Kasim, A., Scarlat, C., & Muhamad, A. (2012). The role of individual differences in promoting front liners to become customer-oriented: A case of the hotel industry in Malaysia. *Journal of Quality Assurance in Hospitality & Tourism*, 13(1), 61-79.
- O'Neill, B.S., & Mone, M.A. (1998). Investigating equity sensitivity as a moderator of relations between self-efficacy and workplace attitudes. *Journal of Applied Psychology*, 83(5), 805-816.
- Pan, W., Sun, L.Y., & Chow, I. H. S. (2011). The impact of supervisory mentoring on personal learning and career outcomes: The dual moderating effect of self-efficacy. *Journal of Vocational Behavior*, 78(2), 264-273.
- Prussia, G.E., Anderson, J.S., & Manz, C. (1998). Self-leadership and performance outcomes: The mediating influence of self-efficacy. *Journal of Organizational Behavior*, 19, 523-538.
- Ramchunder, Y., & Martins, N. (2014). The role of self-efficacy, emotional intelligence and leadership style as attributes of leadership effectiveness. *SA Journal of Industrial Psychology*, 40(1), 1-11.
- Randhawa, G. (2007). Work performance and its correlates: An empirical study. *Vision: The Journal of Business Perspective*, 11(1), 47-55.
- Salami, S. (2010). Emotional intelligence, self-efficacy, psychological well-being and students' attitude: Implications for quality education. *European Journal of Educational Studies*, 2(3), 247-257.
- Schwarzer, R., & Jerusalem, M. (1995). Generalized Self-Efficacy scale. In J. Weinman, S. Wright, & M. Johnston, *Measures in health psychology: A user's portfolio, Causal and control beliefs* (pp. 35-37). Windsor, UK: NFER-NELSON
- Taberero, C., & Hernández, B. (2011). Self-efficacy and intrinsic motivation guiding environmental behavior. *Environment and Behavior*, 43(5), 658-675.

- Taris, T. W. (2006). Burnout and objectively recorded performance: A critical review of 16 studies. *Work & Stress*, 20, 316-334.
- Tourism Bureau (2018). Monthly statistical report. Available at <http://admin.taiwan.net.tw/upload/statistic/20180305/ae787d8a-6251-43b6-8384-20b553ee1efd.xls>
- Vuk, J., Anders, M.E., Mercado, C.C., Kennedy, R.L., Casella, J., & Steelman, S.C. (2015). Impact of simulation training on self-efficacy of outpatient health care providers to use electronic health records. *International Journal of Medical Informatics*, 84(6), 423-429.
- Wang, G., & Netemeyer, R.G. (2002). The effects of job autonomy, customer demandingness, and trait competitiveness on salesperson learning, self-efficacy, and performance. *Journal of the Academy of Marketing Science*, 30(3), 217-228.
- Weiss, D. J., Dawis, R. V., England, G. W. & Lofquist, L. H. (1967). *Manual for the Minnesota Satisfaction Questionnaire*. Minneapolis: University of Minnesota Industrial Relations Center.
- Wood, R., & Bandura, A. (1989). Impact of conceptions of ability on self-regulatory mechanisms and complex decision making. *Journal of Personality and Social Psychology*, 56(3), 407-415.
- Yeh, C.M. (2013). Tourism involvement, work engagement and job satisfaction among frontline hotel employees. *Annals of Tourism Research*, 42, 214-239.
- Zellars, K.L., Hochwarter, W.A., Perrewe, P.L., Miles, A.K., & Kiewitz, C. (2001). Beyond self-efficacy: Interactive effects of role conflict and perceived collective efficacy. *Journal of Managerial Issues*, 8(4), 483-499.

## **Acknowledgements**

This research was funded by a research grant from the Ministry of Science and Technology in Taiwan (MOST 105-2410-H-130 -035 -MY2).

# Determination of the Contributions of Local Authorities to Develop Gastronomy Tourism: Adana Sample

Hulya Tastan, Kemal Enes, and Elanur Sahin

Faculty of Tourism,  
Mersin University, Turkey

## Abstract

The aim of the study is to study the contributions of local authorities to develop gastronomy tourism. Interview method being one of the qualitative research methods is preferred. 10 questions formed by taking interview form literature survey and the studies of Gürbüz, Serçek ve Toprak (2017) as an example, are prepared. The population of the research is formed by tourism sharer of Adana city, research sample is formed by Adana Provincial Directorate of Culture and Tourism and Cukurova Development Agency. Interviews were made on 09th of January 2018 with authorized people working in these institutions. As a result of the interviews, it has been seen that local authorities are aware of gastronomy tourism and they started studies to realize gastronomy tourism potential in Adana. It has been determined that they did plans in the furtherance of Adana gastronomy tourism, gave importance to advertising with activities such as Adana Gastronomy Fest, Gastronomy Market. It has been concluded that the local authorities are the most effective institutions on gastronomy tourism. It has been deduced that they are conscious about gastronomy tourism and they are involved in the activities to develop gastronomy tourism in Adana. The local authorities are suggested to increase studies made on this subject, to study in different populations and sample groups in academic studies and to introduce an integrated study.

**Keywords:** local authorities, gastronomy tourism, Adana

## Introduction

In recent years, tourism has become one of the most researched subjects. Nowadays tourism has economic effects such as increasing the production and providing employment opportunities, providing foreign exchange earnings and stabilizing distribution of income. That's why it is one of the most important service industries for many countries. Because of the reasons such as cities becoming crowded with the increasing populations, job stress and globalization, to be involved in tourism activities has become a social and cultural requirement for people (Keskin, 2015: 144). This situation causes differences in tourism demand. The more tourism demands differentiate, the more new tourism types have been introduced. One of them is gastronomy tourism (Kurnaz, Özdoğan and Akyurt Kurnaz, 2017: 112). Gastronomy tourism has become a tourism type which is attracting a great deal of intention and a growing one with the increasing attention to locality in recent years (Canizares and Guzman, 2012: 229).

Gastronomy tourism which is developing rapidly all around the world is providing an advantage with regards to tourism for countries developed with their gastronomic identities. Since Turkey prevailed in a wide geographical area in Ottoman period, it has a rich food culture as a result of interactions with different ethnic groups. Thus it has a gastronomy tourism potential which can be developed (Türker ve Aksu, 2017: 127). It is more appropriate to go into action starting from local

for the development of tourism in Turkey. In this respect local authorities have important responsibilities for the development of different tourism types (Keskin, 2015: 149).

Local authorities play an important role in the development of tourism and they have a great contribution locally (Cameron, Memon, Simmons and Fairwether, 2001:1). Adana is a city which has a tourism potential open to development with its geographical position, historical and cultural wealth (Ballı, 2016: 5). To enable the realization of this potential is possible with the support of local authorities. The aim of this study is to reveal the contributions of the local authorities to develop gastronomy tourism in Adana and to make a contribution to the literature. In this regard, local authorities and their benefits to develop tourism, gastronomy tourism and Provincial Directorate of Culture and Tourism will be analyzed.

## **Literature Review**

As a result of the literature review made about the subject, firstly local authorities will be mentioned. Then gastronomy tourism will be referred and the contributions of local authorities will be mentioned. Finally some information will be given about gastronomy tourism in Adana.

### *Local Authorities*

There are a lot of studies made on local authorities and different definitions of local authorities are made. Bilgin (2002: 314) defined local authorities as a regime staying out of governmental central organs, administered legally by the state but having its own decision making bodies with its distinctive characteristics and legal entity, elected by local public. In other words; local authorities are the organizations executed by the local organs elected by local public, providing needs of individuals in local society and providing public properties and services (Pustu, 2016: 98). Briefly, local authorities are one of the lower management organs of the state which gives self-governance opportunity to public (Taştekin, 2016: 95).

The origin of the local authorities goes back to the ancient times. Cities in the ancient times, municipalities having local and political jurisdiction in The Roman Empire and city states called “polis” in ancient Greece are one of the first examples of local authorities (Çiçek, 2014: 55). When it is approached sociologically, local authorities are a result of the requirement of communal life. In this respect communities, which is called “commune” where people settle in a place and are organized there, form the basis of present local authorities. Present local authorities are formed as a result of this organization’s executive reconstruction and becoming a legal entity with the addition of some legal authorities (Özel, 2014: 157).

Contemporary local authorities in Turkey emerged in Tanzimat Reform Era. Before Tanzimat, Osmanlı used to have typical organizations which used to give local services. City management in Ottoman was a public work under the central authority and was conducted by the officers appointed by the central authority (Ünal, 2011: 241-242). Present local authorities were founded in the Republic Period. With the Village Law dated 1924 and 1580 Municipal Law dated 1930, the basis for the organizational structure of the local authorities has been formed (Bilgin, 2002: 314-315).

## *Gastronomy Tourism and the Contributions of Local Authorities*

Gastronomy term is a discipline having a long-standing history and many research studies have been made on. On the other hand gastronomy tourism has become a course debated and researched for 10 years. Gastronomy tourism are the journeys that people have, to learn cuisine traditions of different cultures upon their requests to experience foods and beverages belonging to these cultures (Sarıışık and Özbay, 2015: 267). Contribution to the local and regional development is one of the most important factors of gastronomy tourism. It protects local inheritance of foods, develops agricultural production and promotes domestic products (Bucak and Aracı, 2013: 207-208).

Gastronomy tourism is generating motivation to travel with a desire to experience new foods and beverages. Thus the main source of motivation for gastronomy tourism is various gastronomic activities. Food festivals, wine festivals, travels to cuisine museums, tasting local foods and beverages, visiting local producers and restaurants are some of these activities (Kılıç and Gövce, 2017: 68; Alper, Özdoğan and Akyurt Kurnaz, 2017: 115; Türker and Aksu, 2017: 128). These activities carry a local destination onto an international platform and contribute to the development of gastronomy tourism and the destination to gain a competitive advantage against others (Bucak and Aracı, 2013: 205; Üzülmez, Özata, Akdağ, Sormaz and Onur, 2017: 88). Also gastronomy tourism activities contribute to the branding and promoting of cities introducing food culture and gastronomic differences which belong to these cities (Özaltaş Serçek and Serçek, 2015: 23).

Gastronomy tours which have started attracting a great attention across the world are showing up as one of the activities made for gastronomy tourism (Şengül and Türkay, 2016: 89). France, Spain, Italy and Portugal are the countries where gastronomy tours are increasing in Europe. Activities made in these tours are visits to local cheese producers and local bazaars, joining wine festivals, local foods and drinks festivals and etc. (Bitsani and Kavoura: 2012: 304; Güzel Şahin and Ünver, 2015: 6). The Festival of Saint Vincent in France, The Waiheke Wine Festival in New Zeland (Charters, 2009: 374-375), Sheridan's Irish Food Festival in Ireland, Tasting Australia Festival in Australia (Karagiannis & Metaxas, 2017) are some of these events. Thus local foods play an important role in gastronomy tourism since they provide a distinctive experience which belongs to the region (Sims, 2009: 326). When the festivals such as Rice Festival in France Arles, Primi d'Italia in Italy Foligno, Truffle Festival in Alba, and Nantvitch Food Festival in England, were analyzed in his article Thorpe (2008) wrote in The Guardian about 20 Spectacular food festivals, it has been seen that the shareholders and/or sponsors are primarily local authorities and local associations. That's why it is possible to say that gastronomy tourism festivals are being organized thanks to the great contributions of local authorities.

Turkey is an important country for gastronomy tourism with its long-standing history of local food and rich cuisine. Cities such as Adana, Mersin, Gaziantep and Hatay are rich in local products and so have an important potential for gastronomy tourism (Güzel Şahin & Ünver, 2015: 65). Food and drink festivals and local gastronomy tours are held in our country. Watermelon Festival in Adana, Cheese Festival in Balıkesir, Golden Pistachio Festival in Gaziantep, Alaçatı Herbs Festival in Izmir, Cherry Festival in Tekirdağ, (Bucak & Aracı, 2013: 209-210-212); Gourmet Tour in Antakya, Gaziantep Gurmet Tour, Mardin Gurmet Tour (Kızılırmak, Ofluoğlu & Şişik, 2016: 262-263) are only some of the activities made for gastronomy tourism.

When touristic activities in Adana are analyzed, international festivals such as ‘International Adana Film Festival’, ‘Sabancı International Adana Theater Festival’ and ‘The Orange Blossom Carnival’ and events organized by district municipalities such as “Adana Gastronomy Fest’, ‘Cherry Fest” and ‘İmamoğlu Peach Fest’ attract the attention (Adana Kültür Turizm, 2017). Adana Gastronomy Fest which has an important role in the branding and empowering the image of Adana in terms of gastronomy tourism, is an event organized with the support of Governorship and local authorities. With this festival, it is aimed to brand Adana as a gastronomy city and to introduce its local products first nationally and then internationally. The festival is organized with the support of primarily Governor of Adana, Adana Provincial Directorate of Culture and Tourism, Adana Metropolitan Municipality, district municipalities and many local authorities and private sponsors.

Events organized in the scope of gastronomy tourism contribute to the development of local tourism sources and gastronomy tourism. Introduction of local and regional food is an effective way for the development of local economies and tourism (Bucak & Aracı, 2013: 208). To enable this development, local authorities have important responsibilities. Local authorities should develop characteristic projects understanding the importance of gastronomy tourism and should contribute the development of tourism enabling the collaboration between local and central authorities (Keskin, 2015: 149). Local authorities can contribute the development of gastronomy tourism by making strategic plans, having marketing activities and promoting (Ayaz, 2016: 49).

In his study aimed to reveal obstacles in involvement in tourism for municipalities in Turkey, Ayaz (2016) concluded that three important factors cause a challenge against involvement in tourism for municipalities accepted as an important unit of local authorities. Respectively these factors are lack of financial resources, shortage in qualified staff and professional unqualification of present staff. In their study they put forward what the contributions of local authorities are to the local tourism, Karagiannis and Metaxas (2017) local development depends on the implementations of local authorities. They argued that local authorities have control over many aspects of development planning about tourism and so they have a great effect on the development success of tourism. They stated that gastronomy expenditures form one third (1/3) of tourism expenditures and if designed and developed well by local authorities, gastronomy tourism encourages economical and social development. Local gastronomy and tourism implementations can be used as a tool for economical and social development, if they are designed well by local authorities.

### *Gastronomy Tourism in Adana*

Gastronomy tourism is to recognize local cuisine culture, to taste foods and drinks specific to that region and see the growth and/or production of these products. Regions differentiate in terms of the gastronomic products they own. Mediterranean is a region which touristic attraction is high in terms of cuisine culture with many touristic products. Mediterranean Cities have their own distinctive gastronomy potential. “Kunafah” in Hatay, “kebab and turnip” in Adana, “tantuni and cezerye” in Mersin, “tarhana and ice-cream” in Kahramanmaraş, “Piyaz” in Antalya and “walnut spread (ceviz ezmesi)” in Burdur are some of these. Also there are a lot of geographically indicative registered products such as “Finike Orange”, “Anamur Banana”, “Adana Kebab”, “Maras Ice Cream” (Şengül & Türkay, 2016: 89-92).

Adana has a great tourism potential with its geographical position and natural, historical and cultural wealth. The touristic sights such as Stone Bridge and Varda Bridge, the events such as Orange Blossom Fest and Altın Koza International Film Festival have significant contributions to local Tourism (Adana İl Kültür ve Turizm Bakanlığı, 2017). Besides its touristic attraction, with its distinctive cuisine culture, it has a gastronomy tourism potential open to developments (Balı, 2016: 4-10). When we say Adana, the first things that come to our mind are products specific to Adana such as “Kebab”, “şalgam”, “bici bici” and “halka tatlı” (Adana İl Kültür ve Turizm Bakanlığı, 2017). Also Adana takes part in Turkey Tourism Strategy (2023) and at ‘Doğu Akdeniz ve Güneydoğu İnanç ve Gastronomi Turizmi Aksı’ in Action Plan 2007-2013 (Ministry of Culture and Tourism, 2007). In this respect there are several attempts for branding Adana as a gastronomy city and develop gastronomy tourism. “Adana Gastronomy Fest, Kebab and Şalgam fest and Gastronomy Market” are some of these attempts (<http://www.milliyet.com.tr>).

## Methodology

In this study; it is aimed to suggest what the contributions of local authorities are to develop gastronomy tourism. In this respect interviewing method being one of the qualitative research methods is preferred. Interviewing method is the most used one of the qualitative research methods and it allows subject to be considered from the aspects of interviewed individuals. (Yıldırım & Şimşek, 2016). The interview as a part of the study was made on 09th January 2018 in Provincial Directorate of Culture and Tourism where local authorities are most effective on tourism in Adana, with departmental managers and authorities of Cukurova Development Agency. The demographic data about the participants are given in the table below.

**Table 1.** The Demographic Data About the Participants

Working Authority	Gender	Age	Working Year
T.C. Culture and Tourism Ministry/ Adana Province Culture and Tourism Directorate Cukurova Development Agency	Female	35	10
Adana City Council	Male	37	7
Adana Promotion and Development Inc.	Male	29	3

**Table 1.** Questions in the Interview Form

Questions
1 Which studies are being made/must be made for the definition of local cuisine?
2 Have you ever heard about gastronomy tourism?
3 Can Adana be a gastronomy city?
4 What kind of activities should be made to be a city where gastronomy tourism develops?
5 Who do you think should manage the process of being a gastronomy city for developing gastronomy tourism in Adana?
6 What can be the benefits of being a gastronomy city for Adana?
7 What do you advise for the development of gastronomy tourism in Adana?
8 Is there any non-governmental enterprise or community gathering gastronomy employees in Adana?
9 Are there any institution leading gastronomy tourism activities in Adana?
10 Do you have future plans for the development of gastronomy tourism?

Interview form used as a part of the study is formed depending on literature survey and modeling views of experts in data collections and studies of Gürbüz, Serçek and Toprak (2017). In the interview form, 10 questions were asked to learn knowledge of local authorities about gastronomy tourism, to reveal what kind of activities are/may be made in Adana as a part of gastronomy



tourism and to determine the role of local authorities in the activities made. These questions are shown in the Table 1. Answers are noted in the interview form, introduced to expert opinions and interpreted.

## **Findings**

Questions in the research form were asked respectively to the participants. The question “Which studies are being made/must be made for the definition of local cuisine?” was asked to determine what is being done to develop the local cuisine. Participants stated that especially “Salgam”, “Adana Kebap”, “kaynar (the local name of lohusa sherbet)” and “cezerye” were promoted in national and international fairs and presentations were made. Also they mentioned Adana Cuisine promotion was made in brochures and catalogues. Additionally they stated Gastronomy fest made in October 2017 was organized with the participant of Adana Governorship being in the first place and local authorities and it was planned to be traditionalized and repeated every year. One of the participants answered the second question asked to determine whether they had information about gastronomy tourism or not as following; “Of course I have heard. Sea-beach-sun tourism is already out-dated and alternative tourism types such as ecotourism and gastronomy tourism emerged”. Therefore it is possible to say that interviewed individuals have knowledge of gastronomy tourism and they are aware of the related current issues.

When the question “Can Adana be a gastronomy city?” was asked to learn the opinions of participants about Adana’s being a gastronomy city, one of the participants answered that “Adana can be a gastronomy city, we are making studies on it. To promote Adana cuisine, we are coming together once a month with especially gourmets and bloggers writing on Adana. We are planning what we can feature that month about cuisine products, cultural and touristic products”. Starting from this point of view, it will be correct to say that local authorities are aware of that Adana is rich enough for gastronomy tourism and they make their planning accordingly. When they were asked what kind of activities were included or should be made within these planning, they stated that they tried hard to make especially Adana the destination for gastronomy tourism but it could not be a destination by itself alone, it was only possible within ‘Mersin-Adana-Hatay’ Line. They emphasized that the required activities should serve promotion purposes. They pointed out that gastronomy festivals and activities made in social media would have a great contribution to this situation. They answered that all parties of tourism such as municipalities, associations, development agencies and chambers of commerce should be together to the question “Who do you think should manage the process of being a gastronomy city/ studes for developing gastronomy tourism in Adana?” To evaluate the perspective of participants regarding the development of gastronomy tourism in Adana, the question “What can be the benefits of being a gastronomy city for Adana?” was asked. The participants mentioned that the period starting with being a gastronomy city would have a multiplier effect. One of the participants speculated that “after its being a gastronomy city, it would be accompanied by influx of tourists, crafts would grow so the city would grow, when the city grew, the region would grow and finally Turkey grew which would be a multiplier effect.

They suggested that for the development of gastronomy tourism it is a precondition that all parties of tourism should work together. When it was asked whether there were non-governmental organizations in this respect, it was seen that there were many enterprises. Under the Union of Merchants and Craftsmen; Association of restaurateurs (Lokantacılar Derneği), the Federation of

Chefs (Aşçılar Federasyonu), The Federation of Pastry Cooks (Pastacılar Federasyonu) and the Federation of Kebab Shops (Kebapçılar Federasyonu) are some of these enterprises. It was established that Provincial Directorate of Culture and Tourism affiliated to Adana Governorship and Cukurova Development Agency are the institutions working on gastronomy tourism. Finally the question “Do you have future plans for the development of gastronomy tourism?” was asked and one of the participants answered that “By our directorate for tourism, Strategic Action Plan and the Master Plan of our city were made and gastronomy plans take an important place within them.

## **Conclusions**

Gastronomy tourism has become an important subject going on rapidly with the emerging of alternative tourism types day by day, consumers’ becoming more conscious and the increasing tendency towards local authorities. The development of gastronomy tourism can be ensured by beginning action from local as it is for the development of tourism. At this point local authorities are in the most effective position. Provincial Directorates of Culture and Tourism and Development Agencies are the institutions which develop strategies for the development of gastronomy tourism, make regional planning and take actions accordingly sharing these planning with all parties. In this direction, it is aimed to analyze local authorities in Adana to put forward the roles of local authorities in the development of gastronomy tourism with this study. With this aim; using interview method being one of the qualitative research methods, interviews were made with Adana City Culture and Tourism Directorate and Cukurova Development Agency.

In the interviews 10 questions in the research form prepared before, were asked respectively to the participants. When the obtained results are analyzed, it has been seen that local authorities have enough knowledge about gastronomy tourism, are aware of gastronomy tourism potential of Adana and make planning and practices to fulfill this potential. All interviewed participants stated that the initial condition for the development of gastronomy tourism was that all parties of tourism to collaborate. Then they said that festivals and promotions to be made on social media were the most effective practices. They indicated that activities such as Gastronomy Fest and Gastronomy Market are the practices made for the development of gastronomy tourism and they would maintain continuity of these practices.

According to the information obtained as a result of the interviews, it is possible to say that local authorities are effective enough to develop gastronomy tourism. Planning should be formed beginning from local and practices should be started in local with the support of local authorities. All local authorities affiliated to Governorship such as Provincial Directorate of Culture and Tourism in the very first place, municipalities, non-governmental organizations, and development agencies should make planning working collectively and start practices taking action from local. Adana has a high potential for gastronomy tourism and local authorities have enough knowledge about this subject. This situation is very significant for the development of gastronomy tourism.

With this study; it is aimed to put forward how important local authorities to develop gastronomy tourism and to contribute to the literature as a study made on this subject over Adana example. On the other hand the study is limited since it has been made on only Adana example. For future studies; it is advised to study different cities or make an integrated research.

## References

- Atvur, S. (2009). Yerel Gündem 21 ve Çevre: Antalya Kent Konseyi Örneği, C. Ü. Sosyal Bilimler Dergisi, Cilt: 35, Sayı: 2, 231-241.
- Ayaz, N. (2016). Turizmde Yerellik ve Yerel Yönetimlerin Turizme Katılım Engelleri, Çağdaş Yerel Yönetimler, Cilt: 25, Sayı: 1, 47-60.
- Ballı, E. (2016). Gastronomi Turizmi Açısından Adana Sokak Lezzetleri, Journal of Tourism and Gastronomy Studies, Volume: 4, Issue: Special Issue 1, 3-17.
- Bilgin, M. (2002). Yerel Yönetimlerin Bölgesel Kalkınmadaki Etkinliği: Göller Bölgesi Uygulaması, Süleyman Demirel Üniversitesi İktisadi Ve İdari Bilimler Fakültesi, Cilt:7, Sayı:2, 313-330.
- Bitsani, E. ve Kavoura, A. (2012). Connecting Oenological and Gastronomic Tourisms at the Wine Roads, Veneto, Italy, For The Promotion and Development Agrotourism, Journal of Vacation Marketing, Vol: 18, No: 4, 301-312.
- Bucak, T. ve Aracı, Ü. E. (2013). Türkiye’de Gastronomi Turizmi Üzerine Genel Bir Değerlendirme, Balıkesir University The Journal of Social Sciences Institute, Volume: 16, Number: 30.
- Cameron, A.M., Memon, A., Simmons, D.G. ve Fairweather, J.R. (2001). Evolving Role of Local Government in Promoting Sustainable Tourism Development on the West Coast, Tourism Recreation Research and Education Centre, Report No: 28.
- Charters, S. (2009). New World and Mediterranean Wine Tourism: A Comparative Analysis, Original Scientific Paper, Vol:7, No:4, 369-379.
- Çiçek, Y. (2014). Geçmişten Günümüze Türkiye’de Yerel Yönetimler, KSÜ Sosyal Bilimler Dergisi, Cilt:11, Sayı:1, 53-64.
- Çukurçayır, M. A., Eroğlu, T. ve Sağır, H. (2012). Yerel Yönetişim, Katılım ve Kent Konseyleri, ?
- Güzel Şahin, G. ve Ünver, G. (2015). Destinasyon Pazarlama Aracı Olarak “Gastronomi Turizmi”: İstanbul’un Gastronomi Turizmi Potansiyeli Üzerine Bir Araştırma, Journal of Tourism and Gastronomy Studies, Vol: 3, Sayı: 4, 63-73.
- IHA (2017, 14 Eylül). Adana Gastronomi Kenti Oluyor. Milliyet. Erişim Adresi: <http://www.milliyet.com.tr/adana-gastronomi-kenti-oluyor-adana-yerelhaber-2275434/>
- Karagiannis, D.ve Metaxas, T. (2017). Local Authorities Contribution on Gastronomy Tourism Development: The Case of Ontario, Canada, MPRA, Paper No:79325.
- Keskin, A. (2015). Yerel Kalkınmada Yerel Yönetimlerin Rolü: Turizm Örneği, Atatürk Üniversitesi İktisadi ve İdari Bilimler Dergisi, Cilt:30, Sayı:1, 143-154.
- Kılınç, A. (2017). Yerel Ölçekte Siyasal Katılım ve Temsiliyet Açısından Adana Kent Konseyi, ?
- Kızılırmak, İ., Ofluoğlu, M. ve Şişik, L. (2016). Türkiye’de Uygulanan Gastronomi Turları Rotalarının Web Tabanlı Analizi ve Değerlendirmesi, Journal of Tourism and Gastronomy Studies, Vol: 4, Special Issue 1, 258-269.
- Kurnaz, A., Özdoğan, O.N. ve Akyurt Kurnaz, H. (2017). Gastronomi Turizmi İçin Bir Destinasyon Önerisi: Daçça, Detay Yayıncılık, Ankara.
- Özaltaş Serçek, G. ve Serçek, S. (2015). Destinasyon Markalaşmasında Gastronomi Turizminin Yeri ve Önemi, Journal of Tourism Theory and Research, 1/1, 22-40.
- Özel, M.(2014). Yerel Yönetim Bilimi ve Ayrı Bir Disiplin Olarak Gelişme Sorunu, Uluslararası Alanya İşletme Fakültesi Dergisi, Cilt:6, Sayı:3, 153-164.
- Pustu, Y. (2016). Yerel Demokrasinin Kökeni, Sayıştay Dergisi, Sayı: 100, 89-107.
- Sánchez-Cañizares, S.M. ve López-Guzmán, T. (2012). Gastronomy as a Tourism Resource: Profile of the Culinary Tourist, Current Issues in Tourism, Vol:15, No:3, 229-245.
- Sarışık, M. ve Özbay, G. (2015). Gastronomi Turizmi Üzerine Bir Literatür İncelemesi, Anatolia: Turizm Araştırmaları Dergisi, Cilt: 26, Sayı: 2, 264-278.
- Sims, R. (2009). Food, Place and Authenticity: Local Food and The Sustainable Tourism Experience, Journal of Sustainable Tourism, 17:3, 321-336.
- Şengül, S. ve Türkay, O. (2016). Akdeniz Mutfak Kültürünün Gastronomi Turizmi Bağlamında Değerlendirilmesi, Journal of Tourism and Gastronomy Studies, Vol: 4, Special Issue 1, 86-99.
- Taştekin, A. (2016). Kent Konsey’lerinin Yerel Demokrasi Açısında İşlevselliği (Gaziantep Örneği), Gazi Üniversitesi İktisadi ve İdari Bilimler Fakültesi Dergisi, Cilt:19, Sayı:1, 95-109.
- Thorpe, A. (2008). 20 Fabulous Food Festivals, The Guardian. Erişim adresi: <https://www.theguardian.com/travel/2008/sep/07/travelfoodanddrink.foodanddrink>
- Türker, N. ve Aksu, S. (2017). Çerkes Mutfak Kültürünün Gastronomi Turizmi Kapsamında Değerlendirilmesi: Düzce İli Örneği, Detay Yayıncılık, Ankara.

- Ünal, F. (2011). Tanzimattan Cumhuriyete Türkiye’de Yerel Yönetimlerin Yasal ve Yapısal Dönüşümü, Dumlupınar Üniversitesi Sosyal Bilimler Dergisi, Sayı:30, 241-248.
- Yıldırım, A. (2014). Türkiye’de Yerel Yönetişimin Uygulanabilirliği ve Yerel Gündem 21 Örneği Üzerinden Bir İnceleme, Muş Alparslan Üniversitesi Sosyal Bilimler Dergisi, Cilt: 2, Sayı: 1, 75-96.
- Yıldırım, A. & Şimşek, H. (2016). Sosyal Bilimlerde Nitel Araştırma Yöntemleri, Seçkin Yayıncılık, Ankara.

# **The Effects of Personality Traits of Employees on Their Socialization Levels: A Research in Hospitality Establishments**

Eda Ozgul Katlav<sup>1</sup>, Nilufer Sahin Percin<sup>1</sup>, and Muhittin Cavusoglu<sup>2</sup>

<sup>1</sup>Tourism Faculty  
Nevsehir Haci Bektas Veli University, Turkey  
<sup>2</sup>College of Education  
University of South Florida, USA

## **Abstract**

This study aims to determine the effect of personality traits which employees bear on the socialization levels they display. Data was collected from the population composed of employees working at boutique hotel establishments operating in the Province of Nevsehir with questionnaire technique and assessed in terms of statistics. As a consequence of the regression analysis used to test the hypotheses, it was revealed that their personality traits positively and significantly affected the organizational commitment, organizational acceptance, motivation and job satisfaction which are socialization levels. It is expected that the findings regarding the study will contribute to this field as a limited number of researches have been made particularly in terms of tourism literature.

**Keywords:** personality traits, socialization level, boutique hotel, Nevsehir

## **Introduction**

The positive effect of services sector on sustainable economic growth in the world and especially employment and competitive advantage is evident as a talent of the sector. On the other hand, the hospitality establishments, one of the important components of tourism, which take a big share from the sector, have to improve their talents so as to be able to offer service depending upon customer satisfaction. Since it is in the service of a labor-intense sector, how human resources, one of the important talents in the hotel establishments depending on labor force more than other sectors, are administrated, has also importance. The employees' wish to continue to stay in the organization is associated with their job satisfaction. One of the important determiners of this attitude is their socialization levels beginning to form at the onset of their recruitment and changing in time. Therefore, it is essential that according to what socialization levels of employees change, in other words their precursors, be put forth. It is seen in the literature that personality trait is one of the factors affecting socialization level. From this viewpoint, the effect of personality traits that employees have on the socialization level they display is investigated in this study. Firstly, the terms have been defined and their relations with each other have been explained in the light of literature and hypotheses have been developed. Secondly, suggestions have been made for the future studies by using the findings obtained.

## **Literature Review**

### *Personality Traits*

Personality traits determine the attitude of people to the difficulties encountered in life and their efforts to perform a task or sustain it (Karaman et al. 2008: 51). Although there are models for what the characteristics defining personality differences and representing their structure are

available in the literature, it is seen that generally the five-factor model is often used (Barrick & Mount, 1991; Judge et al., 1999; Gosling et al., 2003). The model explains the personality in five basic dimensions as “extroversion”, “neuroticism”, “agreeableness”, “emotional stability” and “openness to experience” (Barrick & Mount, 1991: 1). It is thought that classification of employees according to certain types will be more effective on determining the requirements of people, resolving their problems and getting to know them more closely especially with respect to the employees living in organizational environments. In the same way, the attitude displayed by personality is also significant for the organization. For instance; proactive personality, sociability, self-improvement is important in terms of personal development. The job life spent in harmony with the personality could be effective at the employee’s continuing the present position in spite of the other opportunities offered (Ibrahimoglu, 2008: 94). In this respect, one of the important issues the organizations dwell upon is that employees bearing different personality traits and working in a certain career direction should take part in the organization in order to form socialization.

### *Organizational Socialization*

Organizational Socialization is the process in which newly recruited employees for the organization acquire the knowledge, attitude and behavior required to be able to feel themselves as a permanent member of the organization (Calik, 2003: 163). The main purpose of organizational socialization is the employees’ complying with the same norms and values as the other staff do and to sustain the supervision of their sharing them in the organization (Iplik et al., 2012: 102). Organizations try to make individuals adjust their abilities and qualities to the organization and new employees try to learn the standards of the organization and the way of conducts they include so as to be successful and acceptable organization members. Both the employees’ being satisfied with the work they perform, and the realization of the organizational objectives depend upon the effectiveness of socialization process. It is accepted as one of the primary tools particularly on the subject that employees adopt organizational values, norms and behaviors at hotel institutions (Sokmen & Tarakcioglu, 2008: 37-38). In the study, organizational commitment, organizational acceptance, motivation and job satisfaction have been examined as socialization levels. Organizational commitment is defined as a behavior shaped by the employee’s relation with the organization and enabling them to decide to be a permanent member of the organization (Allen & Meyer, 1996: 255). Organizational acceptance is the behaviors aimed at employees’ obeying the rules in the organization, adopting these rules and trying to make them widespread and it was studied by Smith et al. (1983) for the first time. Motivation is what makes people move and determines the direction of their behaviors, is their thoughts, hopes, faiths, shortly their desire, needs and fears (Findikci, 2000: 373). Job satisfaction has been defined as the feeling of contentment arising in the person and the positive attitude of the employee towards his job as a consequence of the harmony between the person in question and his working conditions or the work life (Ugboro & Obeng, 2000: 254).

The socialization level of the employees they display being high is important in respect to the efficiency of the organization. Hence, it is required that the factors affecting the socialization levels of the employees should be examined. According to the literature concerned, it is seen that one of the factors can be the personality traits (Becker & Strauss, 1956; Hoffman, 1970; Zigler & Child, 1973; Eisenberg et al., 1991; Ibrahimoglu, 2008; Yagci & Ilarslan, 2011; Ozcan & Behram, 2013; Baltes & Schaie, 2013; Buss & Plomin, 2014; Deniz, 2016).

## *Purpose of the Study*

The purpose of this study is to reveal how the personality traits of the employees who work at hotel establishment affect the socialization levels they exhibit. There are studies in the previous researches in which both personality traits and socialization levels were examined separately and in different sectors. However, as both of the variations were not much studied together as a subject of research at hotel establishments and a new one added to the present studies (Pelian, 2008; Lee et al., 2011; Deniz, 2016), this study has a significance.

## **Methods**

### *Participants*

The population in the application field of the study was determined as the employees working at small hotels in the Province of Nevsehir promoted as boutique hotels on web sites and having the status of “Special Establishment with Tourism Management License “from Culture and Tourism Ministry. Data used in the research was collected in May-June months of 2017. According to the information provided by Nevsehir Provincial Culture and Tourism Directorate, about 40 boutique hotels and /or boutique hotel style establishments exist in the region. Yet, the employees working at the boutique hotels with 10 rooms or more of these were targeted since there is” the criteria of at least 10 rooms “in the standard issued by Culture and Tourism Ministry. The population was determined according to the information obtained from the Human Resources departments of the hotels in question, with reference to the total staff number was about 115 and all of this number was available. Accordingly, a total of 115 questionnaires were distributed to the hotels by the author on condition that they should be collected later and 99 of the distributed questionnaires were returned. According to Buyukozturk (2005: 12), it is essential that the number of the returned questionnaires should be 70-80 % in order to be able to make a reliable assessment. In this study, the returned questionnaires rate was 86 %, thus, this rate can be scientifically acceptable.

### *Measures*

The employees were interviewed with sample questionnaire form for the purpose of measuring the perception of the personality traits and socialization levels of the employees working at the hotel establishments. In the first chapter, the statements aimed at the personality traits and socialization levels of the employees and in the second chapter demographic questions are included. Responses are taken with 5 Likert type scale (1=Definitely Disagree, 2=Disagree, 3=Neither Agree nor Disagree, 4=Agree, 5=Definitely Agree) . Two scales used in the study are also the ones the validity of which have been approved in tourism literature. The cultural adaptation of the scale used in the measurement aimed at determining personality traits was made by Alkan (2012). Also the validity analyses of the scale were made in the doctorate thesis in which the relations between “estrangement and five factor personality traits were studied on hotel staff” by Tekin (2012). The validation of the scale used to determine the socialization levels in hospitality sector was made by Sokmen and Tarakcıoglu (2008).

### *Five Factor-Personality Traits Scale*

In the scale, aimed at defining the personality traits of the employees, “Five Factor-Personality Traits Scale”, composed of five sub-dimensions and 44 questions as neuroticism (eight items),

extroversion (eight items), openness to experience (10 items), agreeableness (nine items) and emotional stability (nine items), developed by John et al. (1991), was used. In this study, the reliability coefficient (Cronbach's Alpha) is calculated as .86. According to Nunnally (1978), a scale is supposed to be over 0.70 so as to be accepted as reliable scientifically. Thus, this scale can be claimed to be reliable.

### *Organizational Socialization Degree Scale*

In the scale, aimed at defining the socialization levels of the employees, "Organizational Socialization Levels Scale", composed of four sub-dimensions and 50 questions as organizational commitment (13 items), organizational acceptance (12 items), motivation (13 items) and job satisfaction (12 items), developed by Kartal (2003), was used. In this study, the reliability coefficient is calculated as .94.

### *Theoretical Framework and Hypotheses Development*

A research model was formed, and hypotheses was developed depending on the relevant studies in the literature. In the study, the personality traits of the employees was also examined as a factor affecting the socialization level dimensions of the employees working at the hotel businesses. The suggested research model (fig. 1) and hypothesis (table 1) are as follows.

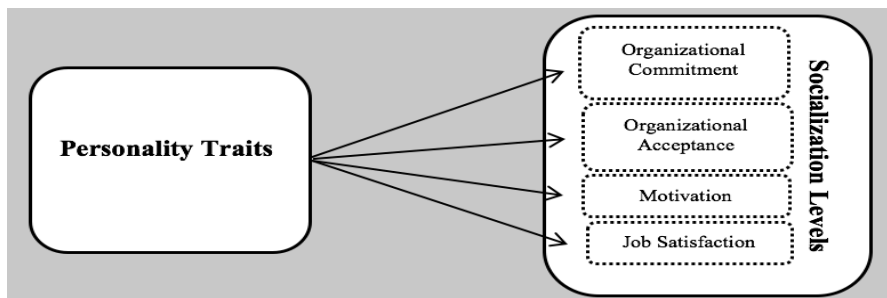

**Figure 1.** The hypothesized model of the study

In the literature the present research results conducted on different sectors indicate that the personality traits of the employees positively and meaningfully affect their organizational commitment, organizational acceptance, motivation and job satisfaction which are the socialization levels they display (Atkinson, 1983; Humphreys & Revelle, 1984; Costa & McCrae, 1992; Organ & Ryan, 1995; DeNeve & Cooper, 1998; Tanoff & Oregon, 1999; Connolly & Viswesvaran, 2000; Judge et al., 2002; Raja & Johns, 2004; Erdheim et al., 2006; Yelboga, 2006; Burke et al., 2006; Ibrahimoglu, 2008; Furnham & Chamoro-Premuzic, 2009; Matzler et al., 2011; Panaccio & Vanderberghe, 2012; Deniz, 2016; Demir et al., 2017). In addition, the researchers conducted at hotel establishments present the same results (Peilan, 2008; Lee et al., 2011; Zou et al., 2011). The following hypotheses concerning the personality traits as a factor affecting the socialization levels of the employees working at hotel institutions are as follows:

### *Hypotheses*

- **Hypothesis 1:** Personality traits have positive effect on organizational commitment dimension of socialization



- **Hypothesis 2:** Personality traits have positive effect on organizational acceptance dimension of socialization
- **Hypothesis 3:** Personality traits have positive effect on motivation dimension of socialization
- **Hypothesis 4:** Personality traits have positive effect on job satisfaction dimension of socialization

## Findings

### *Descriptive Statistics and Correlation Analysis*

Considering the demographic characteristics of the hotel employees participating in the research; 42.4 % of the responders is 26-35 age scale, 55.6 % male, 52.5 % married, 38.4% high school and same level school graduate, 39.4% with an experience of 1-5 years. More than half of the participants have a tourism management degree and most of them are front office, housekeeping and food & beverage department staff.

**Table 1.** Defining Statistics, Correlation Between the Variables and Cronbach's Alpha Values

	1	2	3	4	5
1. Personality Traits	(.86)				
2. Organizational Commitment	.726**	(.82)			
3. Organizational Acceptance	.619**	.663**	(.79)		
4. Motivation	.691**	.820**	.774**	(.79)	
5. Job Satisfaction	.603**	.752**	.743**	.818**	(.82)
Average	3.5967	3.7471	3.7871	3.6646	3.7286
Std. Deviation	.49201	.64531	.61556	.61325	.62842

\*\* p<.01

Average, standard deviation concerning personality traits and socialization levels, correlation coefficient between the variables and Cronbach's alpha values are given in Table 1. When correlation analysis results are examined, it is seen that there is a very strong relation between personality traits and organizational commitment ( $r=.726$ ;  $p<.01$ ), organizational acceptance ( $r=.619$ ;  $p<.01$ ), motivation ( $r=.691$ ;  $p<.01$ ) and job satisfaction dimensions ( $r=.603$ ;  $p<.01$ ) of socialization.

### *Hypotheses Test*

Simple linear regression analysis was made so as to determine the effect of personality traits on socialization levels.

**Table 2.** Regression Analysis Results Regarding Organizational Commitment in Respect to Personality Traits

Independent Variable	Std. $\beta$	Std. Error	t Value	Sig.	R <sup>2</sup>	Adjusted R <sup>2</sup>	F	Durbin-Watson
Invariable	.321	.332	.967	.336				
P.T.	.953	.092	10.404	.000	.527	.523	108.251	2.067

Dependent Variable: Organizational Commitment

\*\*p<.01

As seen in Table 2, it is determined that personality traits have a positive and significant effect on organizational commitment ( $\beta=.953$ ;  $p<.01$ ). It can be said that 52 % of the variations in organizational commitment is explained by personality traits (Adjusted  $R^2=.523$ ) and personality traits are important determiners of organizational commitment ( $t=10.404$ ;  $p=.00$ ). On account of this, Hypothesis 1 is accepted.

**Table 3.** Regression Analysis Results Regarding Organizational Acceptance in Respect to Personality Traits

Independent Variable	Std. $\beta$	Std. Error	t Value	Sig.	$R^2$	Adjusted $R^2$	F	Durbin-Watson
Invariable	1.000	.362	2.763	.007				
P.T.	.775	.100	7.768	.000	.384	.377	60.350	2.260

Dependent Variable: Organizational Acceptance

\*\* $p<.01$

In Table 3, it is seen that personality traits have a positive and significant effect on organizational acceptance ( $\beta=.775$ ;  $p<.01$ ). It can be stated that 38 % of the variation in organizational acceptance is explained by personality traits. (Adjusted  $R^2=.377$ ) ( $t=7.768$ ;  $p=.00$ ). Therefore, Hypothesis 2 is accepted.

**Table 4.** Regression Analysis Results Regarding Motivation in Respect to Personality Traits

Independent Variable	Std. $\beta$	Std. Error	t Value	Sig.	$R^2$	Adjusted $R^2$	F	Durbin-Watson
Invariable	.565	.332	1.702	.092				
P.T.	.862	.091	9.426	.000	.478	.473	88.844	2.054

Dependent Variable: Motivation

\*\* $p<.01$

As seen in Table 4, it is determined that personality traits have positive and significant effect on motivation ( $\beta=.862$ ;  $p<.01$ ). It can be said that 47 % of the variation in motivation is explained by personality traits. (Adjusted  $R^2=.473$ ) ( $t=9.426$ ;  $p=.00$ ). Thus, Hypothesis 3 is accepted.

**Table 5.** Regression Analysis Results Regarding Job Satisfaction in respect to Personality Traits

Independent Variable	Std. $\beta$	Std. Error	t Value	Sig.	$R^2$	Adjusted $R^2$	F	Durbin-Watson
Invariable	.959	.376	2.553	.012				
P.T.	.770	.103	7.443	.000	.363	.357	55.393	1.587

Dependent Variable: Job Satisfaction

\*\* $p<.01$

According to Table 5, it is seen that personality traits have positive and significant effect on job satisfaction ( $\beta=.770$ ;  $p<.01$ ). It can be expressed that 36 % of the variation in job satisfaction is explained by personality traits. (Adjusted  $R^2=.357$ ) ( $t=7.443$ ;  $p=.00$ ). Therefore, Hypothesis 1 is accepted.

## Conclusion

This study aims to be able to define the effect of personality traits on the socialization level. The number of researches examining the relation of dependent variable with independent variable is

limited (Pelian, 2008; Lee et al., 2011; Zou et al., 2011; Deniz, 2016). Therefore, this study aims to fill in the gap to some extent.

In the direction of the findings obtained at the research, a positive and significant relation between personality traits and all levels of socialization is detected and all the hypotheses are supported. Accordingly, the extrovert individuals tend to show loyalty to the organization, to adopt the organization, to be motivated and satisfied by the work done as a consequence of their emotional state as they are warm-hearted, sociable and joyful individuals in interpersonal respect (Barrick&Mount, 1991; Tanoff&Oregon, 1999; Ng et al., 2005; Judge et al., 2008; Demir et al., 2017). Harmonious employees experience all levels of socialization at high points since they bear the characteristics such as flexibility, cooperativeness, forgiveness, kind-heartedness and tolerance (Tanoff&Oregon, 1999; Judge et al., 2001; Burke et al., 2006; Demir et al., 2017). Self-discipline; as it means being disciplined, acting with work-love and responsibility and the self-disciplined employees highlight the ethical aspect of the work more, it is likely that such people exhibit stronger socialization (Barrick&Mount, 1991; Tanoff&Oregon, 1999; Judge et al., 2002; Raja&Johns, 2004; Ng et al., 2005; Winkelmann&Winkelmann, 2008). The individuals open to experience at high level are described as imaginative, adventurous, original, curious, introvert whereas the ones at low level are described as conventional, conservative, indifferent. The individuals open to experience will be able to improve their feelings of commitment, acceptance, motivation and satisfaction concerning their organizations in connection with the approach of the organization to the innovations (Barrick&Mount, 1991; Ng et al., 2005; Demir et al., 2017). The individuals having neurotical character at high level experience emotional instability and are described with attributes such as restless, nervous, irritable, pessimistic, problematic, depressed, anxious, skeptical and tense. Hence, working with emotionally balanced employees will be possible by employing such people at the very beginning. Because neurotical people can only sustain the efforts for socialization aimed at benefitting from financial facilities due to the fact that they can not manage their job relations effectively and have negative feelings to the organization (Tanoff&Oregon, 1999; Judge et al., 2002).

As there is a positive correlation between the notions, the increase in one will affect the other and lift the performance of all the mechanisms in the organization up to higher levels. Because of this effect, the hotel establishments need to be in the effort of developing a policy towards increasing the socialization. The administrators' considering the personality traits of the employees and employing the individuals having appropriate personality traits will be a proper application particularly during the stages of employment and orientation of the human resources management processes. Determination of which personality trait is positively related to socialization can provide significant data for policy makers about this process. By determining the personality dimensions of both the new applicants for the job and the existing employees, how to treat and behave them can be estimated and placing employees having certain personality traits on certain positions can be more beneficial.

The results of this study in which the relation of personality traits with socialization levels are investigated have been obtained in the direction of the data taken from the employees working at the boutique hotels, reputable and well-known in Cappadocia region. That the population is specific and restricted might have affected the results. Consequently, the effect of the sector and establishments mentioned upon the society should be taken into consideration and the relations detected in the research should be repeated on a different sampling while interpreting the findings

of the study. Hence, the perceptions regarding these sectors and the results of these perceptions could be evaluated by researching whether within the sector on an extended sampling or in different sectors. It can be suggested that the dimension of the personality should be included in the research model and its effect on socialization level and various notions be investigated in the prospective studies.

## References

- Alkan, N. (2007). Beş faktör kişilik ölçeğinin geçerlik ve güvenirlik çalışması. *Ankara: Yayınlanmamış Araştırma*.
- Allen, N. J., & Meyer, J. P. (1996). Affective, continuance, and normative commitment to the organization: An examination of construct validity. *Journal of vocational behavior, 49(3)*, 252-276.
- Atkinson, J. W. (1983). *Personality, motivation, and action: Selected papers*. Praeger Publishers.
- Baltes, P. B., & Schaie, K. W. (Eds.). (2013). *Life-span developmental psychology: Personality and socialization*. Academic Press.
- Barrick, M. R., & Mount, M. K. (1991). The big five personality dimensions and job performance: a meta-analysis. *Personnel psychology, 44(1)*, 1-26.
- Becker, H. S., & Strauss, A. L. (1956). Careers, personality, and adult socialization. *American journal of sociology, 62(3)*, 253-263.
- Burke, R. J., Matthiesen, S. B., & Pallesen, S. (2006). Personality correlates of workaholism. *Personality and Individual Differences, 40(6)*, 1223-1233.
- Buss, A. H., & Plomin, R. (2014). *Temperament (PLE: Emotion): Early developing personality traits* (Vol. 3). Psychology Press.
- Büyüköztürk, Ş. (2005). Anket geliştirme. *Türk Eğitim Bilimleri Dergisi, 3 (2)*, 133-151.
- Connolly, J. J., & Viswesvaran, C. (2000). The role of affectivity in job satisfaction: A meta-analysis. *Personality and individual differences, 29(2)*, 265-281.
- Costa, P. T., & McCrae, R. R. (1992). Normal personality assessment in clinical practice: The NEO Personality Inventory. *Psychological assessment, 4(1)*, 5-13.
- Çalık, T. (2003). İşgörenlerin Örgüte Uyumu (Örgütsel Sosyalizasyon).
- Demir, C. G., Demir, E., & Bolat, Y. (2017). Sınıf Öğretmenlerinin Motivasyonları İle Kişilik Özellikleri Arasındaki İlişki/The Relationship Between Characteristics of Primary School Teachers and Their Motivations. *Mustafa Kemal Üniversitesi Sosyal Bilimler Enstitüsü Dergisi, 14(37)*, 73-87.
- DeNeve, K. M., & Cooper, H. (1998). The happy personality: A meta-analysis of 137 personality traits and subjective well-being. *Psychological bulletin, 124(2)*, 197-229.
- Deniz, G. (2016). Kişilik ve Sosyalizasyonun Duygusal Emek Üzerindeki Etkisi: Butik Otel Örneği. *Anatolia: Turizm Araştırmaları Dergisi, 27(2)*, 273-289.
- Eisenberg, N., Fabes, R. A., Schaller, M., Miller, P., Carlo, G., Poulin, R., ... & Shell, R. (1991). Personality and socialization correlates of vicarious emotional responding. *Journal of personality and social psychology, 61(3)*, 459-470.
- Erdheim, J., Wang, M., & Zickar, M. J. (2006). Linking the Big Five personality constructs to organizational commitment. *Personality and individual differences, 41(5)*, 959-970.
- Fındıkçı, İ. (2000). İnsan kaynakları yönetimi. *Alfa Yayınları, İstanbul*.
- Furnham, A., Eracleous, A., & Chamorro-Premuzic, T. (2009). Personality, motivation and job satisfaction: Hertzberg meets the Big Five. *Journal of managerial psychology, 24(8)*, 765-779.
- Gosling, S. D., Rentfrow, P. J., & Swann Jr, W. B. (2003). A very brief measure of the Big-Five personality domains. *Journal of Research in personality, 37(6)*, 504-528.
- Hoffman, M. L. (1970). Moral development. *Carmichael's manual of child psychology, 2*, 261-359.
- Humphreys, M. S., & Revelle, W. (1984). Personality, motivation, and performance: a theory of the relationship between individual differences and information processing. *Psychological review, 91(2)*, 153-184.
- İbrahimoğlu, N. (2008). Kişilik özellikleri açısından örgüt-kariyer bağlılık düzeyini artırmada sosyalizasyon ve mentor etkisi: bir örgüt geliştirme modeli. (Doktora Tezi) *Hacettepe Üniversitesi Sosyal Bilimler Enstitüsü. Ankara*.
- İplik, E., İplik, F. N., & Efeoğlu, İ. E. (2012). İşgörenlerin Örgütsel Sosyalizasyon Düzeylerinin İş Tutumları Üzerindeki Etkisinin Belirlenmesine Yönelik Bir Araştırma. *Çag University Journal of Social Sciences, 9(2)*, 100-115.

- John, O. P., Donahue, E. M., & Kentle, R. L. (1991). The big five inventory: Versions 4a and 54, institute of personality and social research. *University of California, Berkeley, CA*.
- Judge, T. A., Heller, D., & Mount, M. K. (2002). Five-factor model of personality and job satisfaction: A meta-analysis. *Journal of applied psychology, 87*(3), 530-541.
- Judge, T. A., Higgins, C. A., Thoresen, C. J., & Barrick, M. R. (1999). The big five personality traits, general mental ability, and career success across the life span. *Personnel psychology, 52*(3), 621-652.
- Judge, T. A., Klinger, R., Simon, L. S., & Yang, I. W. F. (2008). The contributions of personality to organizational behavior and psychology: Findings, criticisms, and future research directions. *Social and Personality Psychology Compass, 2*(5), 1982-2000.
- Karaman, K., & Dönder, H. (2008). Öğretmen görüşlerine göre, okullardaki bürokrasi ile örgütsel vatandaşlık arasındaki ilişki. *Kuram ve Uygulamada Eğitim Yönetimi, 53*(53), 49-74.
- Kartal, S. (2003). İlköğretim Okulu Yönetici ve Öğretmenlerinin Örgütsel Sosyalleşme Düzeyleri (Basılmamış Doktora Tezi). *Ankara: Ankara Üniversitesi Eğitim Bilimleri Enstitüsü*.
- Lee, D. C., Chen, C. F., Hung, L. M., & Chen, C. C. (2011). Effects of labor conditions, socialization and personality upon student interns' working willingness in hospitality industry. *African Journal of Business Management, 5*(30), 11813.
- Matzler, K., Renzl, B., Mooradian, T., von Krogh, G., & Mueller, J. (2011). Personality traits, affective commitment, documentation of knowledge, and knowledge sharing. *The International Journal of Human Resource Management, 22*(02), 296-310.
- Ng, H. M., & Bornstein, R. F. (2005). Comorbidity of Dependent Personality Disorder and Anxiety Disorders: A Meta-Analytic Review. *Clinical Psychology: Science and Practice, 12*(4), 395-406.
- Nunnally, J. C., & Bernstein, I. H. (1978). Psychometric theory.
- Organ, D. W., & Ryan, K. (1995). A meta-analytic review of attitudinal and dispositional predictors of organizational citizenship behavior. *Personnel psychology, 48*(4), 775-802.
- Özcan, E. D., & Behram, N. K. (2013). A Tipi Kişilik Özelliklerinin İşkoliklik Eğilimi Üzerine Etkisi: Başarı İçin Çabalama Ve Tahammülsüzlük/Asabiyet Boyutları Açısından Bir Değerlendirme. *Sakarya İktisat Dergisi The Sakarya Journal Of Economics, 85*-110.
- Panaccio, A., & Vandenberghe, C. (2012). Five-factor model of personality and organizational commitment: The mediating role of positive and negative affective states. *Journal of vocational behavior, 80*(3), 647-658.
- Peilan, F. H. G. (2008). Review of the Research on Emotion Work: From the Perspectives of Human Resources Management [J]. *Chinese Journal of Management, 6*, 028.
- Raja, U., Johns, G., & Ntalianis, F. (2004). The impact of personality on psychological contracts. *Academy of Management Journal, 47*(3), 350-367.
- Smith, C. A., Organ, D. W., & Near, J. P. (1983). Organizational citizenship behavior: Its nature and antecedents. *Journal of applied psychology, 68*(4), 653-663.
- Sökmen, A., & Tarakçıoğlu, S. (2008). Otel İşletmelerinde Örgütsel Sosyalleşme Düzeyi Boyutlarının Ölçülmesine Yönelik Bir Araştırma. *Yönetim ve Ekonomi Araştırmaları Dergisi, 6*(9), 37-52.
- Tanoff, G. F. (1999). *Job satisfaction and personality: The utility of the Five-Factor Model of personality* (Doctoral dissertation, University of Oregon).
- Tekin, Ö. A. (2012). Yabancılaşma ve beş faktör kişilik özellikleri arasındaki ilişkiler: Antalya Kemer'deki beş yıldızlı otel işletmeleri çalışanları üzerinde bir uygulama. *Akdeniz Üniversitesi Sosyal Bilimler Enstitüsü, Antalya*.
- Ugboro, I. O., & Obeng, K. (2000). Top management leadership, employee empowerment, job satisfaction, and customer satisfaction in TQM organizations: an empirical study. *Journal of quality management, 5*(2), 247-272.
- Winkelmann, L., & Winkelmann, R. (2008). Personality, work, and satisfaction: evidence from the German Socio-Economic Panel. *The Journal of Positive Psychology, 3*(4), 266-275.
- Yağcı, M. İ., & İlarıslan, N. (2011). Reklamların ve cinsiyet kimliği rolünün tüketicilerin satın alma davranışları üzerindeki etkisi. *Doğuş Üniversitesi Dergisi, 11*(1), 138-155.
- Yelboğa, A. (2006). Investigation of the relationship between personality traits and work performance. *Is-Guc, The Journal of Industrial Relations & Human Resources, 8*(2), 196-211.
- Zigler, E. F., & Child, I. L. (1973). Socialization and personality development.
- Zou, W., Zheng, Y., & Zhu, J. (2011). Information seeking as a mediator between proactive personality and adjustment. *Systems Engineering Procedia, 1*, 294-300.

# The Evaluation of Influence Tactics Perception of Hospitality Establishment Employees in Terms of Demographic Variables

Gaye Deniz<sup>1</sup>, Nilufer Sahin Percin<sup>1</sup>, and Muhittin Cavusoglu<sup>2</sup>

<sup>1</sup>Tourism Faculty  
Nevsehir Haci Bektas Veli University, Turkey  
<sup>2</sup>College of Education  
University of South Florida, USA

## Abstract

This study aims to reveal whether the influence tactics usage of four and five –star hotel employees in Nevsehir differs according to their demographic traits. Influence Tactics Scale was used to collect data. The question papers formed as a data collection tool were left at four and five –star hotels which accepted the application of the questionnaire and collected after a while. The question forms were distributed to a total of 281 employees; however, 217 questionnaires were analyzed. It is investigated which tactics the managers of the employees working at four and five star hotels use and whether the situation of being affected by these tactics show any difference according to demographic variables. In consequence of the analyses performed, it was observed that the age of the employees and the length of working in the sector made a difference in their perception of influence tactics.

**Keywords:** tactics perception, influence tactics scale, four & five star hotel employees, Nevsehir

## Introduction

The number of the empirical researches conducted on the managers' influence behaviors has risen since the 1980's. Influence tactics are defined as objective-oriented behaviors which managers make use of in order to obtain the desired results. It is important that managers use influence tactics and comprehend the impacts of these tactics upon the organizational outcomes. Therefore, researchers have been trying to reveal influence tactics ; the types of tactics used by managers , the probable effects of various tactics and the importance of individual and determining tactics according to the situation ( Yukl , Guinan & Sottolano , 1995 ).

While managers resorting to influence tactics, they should be aware of the traits of employees against whom they intend to apply these tactics. The researches done indicate demographic variables, primarily gender ,alter the managers' influence tactics use and employees' influence tactics perceptions. Demographic variables are able to affect the selection of tactics which managers use to influence employees. For instance; male managers apply rational persuasion tactic whereas female ones apply the manipulation tactic. Besides, variables such as gender, age , work experience , educational status could create differences in employees ' perceiving these tactics and being influenced by them. Hence, managers resort to influence tactics to be able to canalize the employees working at hospitality establishments where production and consumption are performed synchronously to the objective and aim of the organization.

This study aims to reveal how the influence tactics , which the four and five – star hotel managers in Nevsehir use , are perceived by the employees and whether or not this perception differs depending upon the employees' demographic traits ( gender , age , educational status , period of

working in the sector and period of working at the organization). At the end of the research survey, it was determined that the perception of influence tactics varies depending on the employees' age and period of working at the organization.

## Literature Review

### *Influence Tactics*

As management means directing people to the desired behavior, influence takes part in the basis of organization operation. Manager fulfills his responsibility assigned to him by influencing others and enabling them to exhibit certain behaviors. Thus, since the managers' affecting their subordinates is highly important, the managers resort to some tactics to be able to affect their subordinates. Influence Tactic is defined as "Behavior types which a person uses in order to influence one another's attitudes and behaviors" (Yukl, Chaves & Seifert, 2005, 705).

Influence at organizations is defined as the process of guidance to direct the activities of organization members properly. By proper direction, enabling the managerial system to reach its goals through influence is meant. Influence includes organization members' focusing on subjects such as people, their high spirit, building good job connections, conflict management. Influence forms the most crucial aspect of managerial position and in fact, the ability to influence others would become the primary determiner to be a successful manager (Certo, 2000: 304).

According to Yukl (2010), influence tactics consist of rational persuasion, consultation, inspiration, personal appeal, ingratiation, exchange, pressure, legitimation, coalition, cooperation and information dimensions. If dimensions need to be shortly defined; *Rational Persuasion*; the target individual is persuaded to do what is asked from him through rational debates and proofs based on facts. *Consultation*; the individual is sought to participate in the planning a strategy, activity or that person's support and aid is asked, or the individual is asked to fulfill a task related to his interest and suggestions.

*Inspiration*; Increasing the person's confidence for his accomplishing successfully any task asked or making proposals or requests inspiring the person's enthusiasm in direction of his values, ideals and wishes. *Personal Appeal*; is resorting to friendship and loyalty feelings which the person has towards the one opposite him when the person is asked to do a task. *Ingratiation*; is putting the person into a positive mood and making him think friendly about the opposite party before he is asked or suggested to do something (compliments, much friendliness). *Exchange*; promising to share the benefits with the person if he fulfills the task or promising that he will be rewarded in the future in return for the favor he does.

*Pressure*; applying threats, frequent checks or insistent reminders for the person to do what is asked. *Legitimation*; making the demand legitimate by confirming what is asked to be in accordance with the rules, policies, applications and traditions of the organization and stating that its fulfillment is within the jurisdiction of authority or right. *Coalition*; demanding aid from other people to convince the targeted person to do the task or using other people's support in order to make the target person accept what is asked. *Cooperation*; the manager helps the target person or offer to provide the required sources. *Information*; the manager explains how advocating the task asked will be beneficial to the target person and will contribute to his promotion in his career.

### *Influence Tactics and Demographic Traits*

Whether influence tactics usage differs according to gender , educational status , age , etc. or not has been the subject of many studies (Carli, 1999; Carothers & Allen, 1999 ; DuBrin, 1991 ; Lamude , 1993 ; White, 1988 ; Burgoon, Dillard & Doran, 1983 ; Tepper , Brown & Hunt ; 1993 ; Barbuto, Fritz , Matkin & Marx, 2007 ; Castro, Douglas, Hochwarter, Ferriz & Frink, 2003 ) . Yet , most of these studies research whether using influence tactics depending upon gender variable differentiate or not ( Smith ,et al. , 2013 ; Castro , Douglas , Hochwarter, Ferriz & Frink , 2003 ;Thacker, 1995 ; Drory & Breaty , 1991 ; Dubrin , 1991) .Most of the studies reveal that women and men use different influence tactics.

### *The Purpose of The Study*

Tourism sector is a service sector where there is a direct communication with the consumer, labor-intensive, the service is consumed the moment it is produced, the one which has idiosyncrasy. Operational administration at hospitality establishments aims to obtain maximal employee performance by using various motivation tools and influence tactics. The ability to influence others underlies the reaching of hospitality establishments to their goals and administrative achievement. This study aims to reveal whether the influence tactics usage of four and five –star hotel employees in Nevsehir differs according to their demographic traits.

## **Methods**

### *Population and Sampling*

The population of the study composes of four and five –star hotel establishments in Nevsehir. The reason for choosing four and five –star hotels in Nevsehir as the population of study is this region being an important destination in respect with tourism and the administration and organizational structures of these establishments are appropriate for the purpose of this study.

Sampling method was made use of due to the time and cost restrictions of the study and as it is not possible to make a complete counting on the population. In the study judgement sampling method, one of non-random sampling methods, was preferred as a sampling method (Burns & Bush, 2014). The question papers formed as a data collection tool were left at four and five –star hotels which accepted the application of the questionnaire and collected after a while. The question forms were distributed to a total of 281 employees; however, 217 questionnaires were analyzed.

### *Data Collection Tool*

With the sample questionnaire form used to measure the influence tactics perception of the employees working at hotels , the employees were asked .The scales belonging to the variables in the research were translated from English into Turkish and from Turkish into English and any semantic shift of the statements were tried to be avoided. In the question paper / questionnaire prepared in compliance with the purpose of the survey, the questions about the influence tactics and demographic variables ( age , sex , marital status , organization type , period of working in sector and organization ) are included. The research data are collected via the following scales.



*Influence Tactics Scale*; the influence tactics scale of 44 questions and 11 dimensions developed by Yukl, Seifert & Chavez ( 2008 ) for the purpose of measuring influence tactics which managers use was applied. The Influence Behavior Questionnaire developed by Yukl, Seifert & Chavez ( 2008 ) has two main versions as the agent ( the person using the influence tactics ) and target ( the person exposed to the influence tactics ). In this study, the target version of the influence tactics questionnaire was used. Because it was assumed that the employees, exposed to influence tactics in this study, could describe better how much they were affected by influence tactics. It was also supposed that the managers could not respond about the influence tactics they used objectively and manipulate the usage of some influence tactics. 44 statements included in the questionnaire constitute 11 dimensions in 4 groups. The statements included in the scale were measured with a 5 Likert type scale. In the measurement of the statements, Likert type scale of 5 answer categories was used as “ 1 = Never , 2 = Rarely 3 = Occasionally 4 = Frequently 5 = Always”

### *Research Hypotheses*

A number of studies investigating influence tactics in terms of demographic traits exist (Smith et al., 2013 ; Castro , et al. , 2003 ; Thacker , 1995 ; Drory & Beaty , 1991 ; Dubrin , 1991 ) . In these studies, influence tactics used by managers were investigated in terms of demographic dimensions. Nevertheless, in this study, how the influence tactics applied by the managers are perceived by the employees and whether demographic variables differ in this perception or not is investigated. Thus the hypotheses of the research have been formed as follows;

- H<sub>1</sub>: The perceived influence tactics differ according to the employee’s gender.
- H<sub>2</sub>: The perceived influence tactics differ according to the employee’s age.
- H<sub>3</sub>: The perceived influence tactics differ according to the employee’s job type.
- H<sub>4</sub>: The perceived influence tactics differ according to the employee’s length of working in the organization.
- H<sub>5</sub>: The perceived influence tactics differ according to the employee’s length of working in the sector.

### **Findings**

It is seen that the participants of the research compose of 70.1 male and 29.9 % female employees. The employees compose of 40.1 % 18 -28 age group, 30.2 % 29 – 39 age group , 29.7 % 40 and over age group. When seen in terms of the hotel establishment type, 62.4 % composes of 4 star hotels. When seen in terms of the employees’ length of working in the sector , it is found that 51.9 % has worked for 2- 5 years in the sector and when seen with respect to the length of working in the organization , 21.9% has worked for a year and less , 26.2 % has worked for 2 -5 years in the organization.

When the overall average of the influence tactics which the managers use is examined, it is seen that the employees evaluate the frequency of the managers’ influence tactics use is as medium. When influence tactics are examined in terms of dimensions , it is seen that the average rate of rational persuasion (3.81) , cooperation (3.76) , legitimation (4.01), ingratiation (3.81) , exchange (4.00) , information (3.99) , inspiration (3.95) tactics is “ I agree “ (4.00).

Hereby, it can be claimed that these tactics the managers use are more influential on the employees. It is possible to state that the answers given about the use of pressure (3.56), Consultation (3.20), Personal Appeal (3.15) and Coalition (2.53) tactics are relatively lower than the other dimensions. It is seen that of these eleven dimensions coalition tactic has particularly the lowest average rate. Afterwards, the reliability of influence tactics, variables of the survey, was tested. Although there are various analysis types, related to the assessment of the validity, the most commonly used one is Cronbach's Alpha coefficient (Özdamar, 2004:622; Kalaycı, 2010: 405).

That Cronbach's Alpha coefficient belonging to the influence tactics and dimensions is between 0.90 – 0.82 indicates that the scale is reliable. When the results of Confirmatory Factor Analysis, performed regarding to influence tactics, are viewed, it is seen that  $\chi^2/df$ : 2.490; RMSEA: 0.065; GFI: 0.866; CFI: 0.916; NFI: 0.890. According to these results, it is seen that all compliance indexes are between the acceptable range. As it shows compliance to the model, this scale used to measure the frequency of influence tactics use can be said to have structural validity.

#### *Analysis Results Regarding Research Hypotheses*

To test the difference between the demographic variables and influence tactics, the main aim of the research, t-test and ANOVA tests were applied. According to analysis results,  $p > 0,05$  (gender:  $p = 0.751$ ;  $F = 0.101$ ; organization type:  $p = 0.163$ ;  $F = 1.955$ ), it is determined that there is not any difference in the employees' perception of influence tactics with reference to the gender and operation type variables. According to ANOVA test results, conducted in respect to age variable, as  $p < 0,05$  is ( $p = 0.021$ ;  $F = 11.451$ ), the influence tactics perceived according to age variable differ. According to Post – Hoc tests, done on which group the difference belongs to, 18- 28 and 40 and over age group employees' perception of influence tactics is different. 18- 28 age group employees are more affected by influence tactics than 40 and over age group ones.

When the difference between the influence tactics according to the length of working in the organization is investigated,  $p > 0,05$  is identified as ( $p = 0,941$ ;  $F = 0,06$ ). According to these results, there is no difference between influence tactics and the length of working in the organization. However, when the difference between influence tactics and the length of working in the sector is examined, as  $p < 0,05$  is ( $p = 0.028$ ;  $F = 4.857$ ), influence tactics vary. According to Post – Hoc tests, done on which group the difference belongs to, the perception of influence tactics of the employees working in the sector for 2- 5 years is different from that of the employees working in the sector for over 10 years. The employees working in the sector for 2 – 5 years are affected more by influence tactics. Besides, when it is examined with respect to influence tactics dimensions, it is possible to say that the employees who have been working for 14 years and over are more affected by personal appeals and pressure tactics than the other employees.

#### **Conclusions**

Managers need employees to perform their tasks efficiently. Yet, as managers who are unable to lead employees properly could have difficulties in reaching organizational objective and target, they are supposed to influence employees and make them work in line with their aims. Therefore, managers need some tactics. Influence tactics indicate in which way managers need to influence while directing their staff for one task.

In this study , it is investigated which tactics the managers of the employees working at four and five star hotels use and whether the situation of being affected by these tactics show any difference according to demographic variables. In consequence of the analyses performed, it was observed that the age of the employees and the length of working in the sector made a difference in their perception of influence tactics. It was determined that the employees, in 18 -28 age group and the ones who had worked in the sector for 2 -5 years, were more affected than the others by the influence tactics their managers used.

When the age group and the length of working in the sector are investigated , it is possible to state the newly recruited and young employees are more affected by these tactics. It can be claimed that when fulfilling a task , the experienced and senior employees do not take heed of the tactics their manager use so much. Another significant finding is that the employees who have worked at the establishment for 14 years and over are more affected by consultation , personal appeals and pressure tactics. This study has been merely applied on the staff working at the four and five star hotels in Nevşehir due to the restrictions of time and cost. In the prospective studies comparison could be made while applying on employees working in different regions or hotels.

## References

- Barbuto, J. E., Scholl, R. W., Hickox, C. F., & Boulmetis, J. (2001). A field study of the relation between leaders' anticipation of targets' resistance and targets' report of influence tactics used by leaders in dyadic relations. *Psychological Reports, 88*, 835–944.
- Burgoon, M., Dillard, J. P., & Doran, N. E. (1983). Friendly or unfriendly persuasion: The effects of violations by males and females. *Human Communication Research, 10*, 283–294.
- Burns, A. C., Bush, R. F., & Sinha, N. (2014). *Marketing research*(Vol. 7). Boston, MA, USA: Pearson.
- Carli, L. L. (2017). 3 CHAPTER Social Influence and Gender. *The Oxford Handbook of Social Influence, 33*.
- Carothers, B.J. & Alen, J.B. (1999), Relationships of Employment Status, Gender Role, Insult, and Gender with Use of Influence Tactics, *Sex Roles, 41*(5-6): 375-387.
- Castro, S. L., Douglas, C., Hochwarter, W. A., Ferris, G. R., & Frink, D. D. (2003). The Effects-of Positive Affect and Gender on the Influence Tactics-Job Performance Relationship. *Journal of Leadership & Organizational Studies, 10*(1), 1-18.
- Drory, A., & Beaty, D. (1991). Gender differences in the perception of organizational influence tactics. *Journal of Organizational Behavior, 12*(3), 249-258.
- DuBrin, A. J. (1991). Sex and gender differences in tactics of influence. *Psychological Reports, 68*(2), 635-646.
- Kalaycı, Ş. (2010). *SPSS uygulamalı çok değişkenli istatistik teknikleri* (Vol. 5). Ankara, Turkey: Asil Yayın Dağıtım.
- Lamude, K. G. (1993). Supervisors' upward influence tactics in same-sex and cross-sex dyads. *Perceptual and Motor Skills, 77*, 1067–1070
- Özdamar, K. (2004). Paket programlar ile istatistiksel veri analizi (Genişletilmiş 5.baskı). Eskişehir: Kaan Yayınevi.
- Smith, A. N., Watkins, M. B., Burke, M. J., Christian, M. S., Smith, C. E., Hall, A., & Simms, S. (2013). Gendered influence: A gender role perspective on the use and effectiveness of influence tactics. *Journal of Management, 39*(5), 1156-1183.
- Tepper, B. J., Brown, S. J., & Hunt, M. D. (1993). Strength of subordinates' influence tactics and gender congruency effects. *Journal of Applied Psychology, 23*, 1903–1919.
- Thacker, R. A. (1995). Gender, influence tactics, and job characteristics preferences: New insights into salary determination. *Sex Roles, 32*(9-10), 617-638.
- White, J. W. (1988). Influence tactics as a function of gender, insult, and goal. *Sex Roles, 18*, 433–448.
- Yukl, G., Seifert, C. F., & Chavez, C. (2008). Validation of the extended influence behavior questionnaire. *The Leadership Quarterly, 19*(5), 609-621.

## *Part 6: Human Resource Management*

# Demystifying the Antecedents of Presenteeism in Hospitality Industry

Kayode K. Eluwole, Taiwo T. Lasisi and Turgay Avci

Faculty of Tourism  
Eastern Mediterranean University, North Cyprus

## Abstract

This conceptual study develops a model through which hospitality stakeholders especially business owners can minimize the deleterious impact of presenteeism in their organizations. Specifically, our extensive review of literature suggest that knowledge management systems, human capital, organizational climate and talent management are key predictors of presenteeism however, hospitality literature has paid next to no attention to this issue. Our study thereby provides the initial bridge for this identified gap in literature and call for empirical studies to validate the importance of the resulting model based on social cognitive and social learning theories.

**Keywords:** presenteeism, KMS, human capital, talent management, organizational climate

## Introduction

The job demand of the service-oriented organization is enormous. These demands are often associated with the nature of service delivery which includes the intangibility of service, the involvement of customer in the service creation experience amongst others (Elmadağ & Ellinger, 2017). While faced with these job-demands, service employees are also faced with other demands external to the job such as family-related concerns as well as their physiological and psychological well-being. Customer contact employees as they are often referred to; are “at the heart of service provision” (Surprenant & Solomon, 1987) due to their role in delivering quality service to the (An & Noh, 2009; Parasuraman, Zeithaml, & Berry, 1985).

According to Teng and Liu, (2014), these job demand and or stress —have a particularly damaging influence on customer contact employees’ ability to deliver high quality service that satisfies customers. In a similar view, Fisk and Neville, (2011) provided empirical support for the pervasive influence of job-demand on service employees’ occupational health. It is therefore unlikely that when service employees or customer contact employees are committed to delivering quality services that they succumb to the pressure of the job and other related pressures.

Presenteeism in literature has been conceptualized as the impact of being sick on employees’ productivity at work (e.g. Neto, Ferreira, Martinez, & Ferreira, 2017; Zhou, Martinez, Ferreira, & Rodrigues, 2016). It is the loss of productivity by sick employees who has chosen to continue to work with sickness. Although, presenteeism might be considered a positive phenomenon signifying employees’ commitment to the organization, its impact is high detrimental to the overall objective of business organizations if condoned or permitted. It possesses a high risk factor for future poor mental well-being and health (Gustafsson & Marklund, 2011), sickness absenteeism (Demerouti, Le Blanc, Bakker, Schaufeli, & Hox, 2009), and even may represent long-term resource loss for organ (Kivimäki et al., 2005; Taloyan et al., 2012).

It is therefore paramount to investigate the prevalent causes of presenteeism in hospitality industry and attempt to offer preventive mechanism for business owners to avoid increasing occurrence in their establishments. To achieve this objective, the current study based on the review of extant literature develop a model which incorporates organizational-level constructs to propose the influence of organizations on individual employee's behavioral outcome of presenteeism. This study employs Bandura's (1986) social cognitive theory and Social Learning theory to investigate the mechanism through which knowledge management systems, Human capital and organizational climate influences presenteeism directly and indirectly via talent management.

## **Literature Review and Proposition Development**

### *Knowledge Management Systems and Presenteeism*

Nowadays, information technology is reshaping the way businesses are conducted. Many organizations are beginning to realize the importance of "knowledge" to the delivery of high quality services and gaining competitive advantage. To this end, organizations are adopting knowledge management systems to aid their acquisition and use of knowledge to gain competitiveness. When knowledge within the organization is used effectively, management and decision-makers are easily able to underscore the performance capabilities of their employees without requiring the employees to pretend to be active in order to gain positive performance appraisal. Thus we propose that implementing a functional knowledge management system may increase the trust of employees in their employer there by helping the employees to be assured of their position in the organization. Accordingly,

*Proposition 1:* Adequate implementation of KMS in hospitality business organization will negative influence the occurrence of presenteeism such that employees will be more comfortable to express their ailment when necessary and improve productivity.

### *Human Capital and Presenteeism*

Global businesses such as obtainable in the hospitality industry are shifting the focus of their strategies from external source profit orientation to internally generated competencies for competitive edge. To achieve this, organizations are turning their attention to human capital management in which the human assets of the organization are managed and coordinated to achieve organizational performance (Harrop, 2017). Human capital management involves leadership practices (such as inclusiveness, communication, executive and supervisory skills), employee engagement (like job design, commitment and systems), knowledge accessibility (like collaboration, information sharing and availability), workforce optimization (like processes, conditions, accountability and hiring) and learning capacity (like innovation, training and development)(Harrop, 2017).

According to Jiang, Lepak, Hu, and Baer, (2012), firms use HR practices as criteria and methods for managing their employees. The human capital perspective suggests that HR practices affect human capital by prompting the skills, knowledge, and abilities of employees(Cabello-Medina, López-Cabrera, & Valle-Cabrera, 2011; Yang & Lin, 2009; Youndt & Snell, 2004). The implementation of adequate human capital management in firm will ensure that employees work in appropriate positions that will stir up their interest and abilities. Also, human capital

management helps managers to modify trainings and workload of their employees to help them maximize their potentials (Lau, Tong, Lien, Hsu, & Chong, 2017; Lin, Yu-Ping Wang, Wang, & Jaw, 2017).

With organizational focus on internalized management of resource, human capital management helps narrow the gap between top management, supervisors and their subordinates; thus effectively creating avenue for proper communication among member of staff which will prevent the occurrence of presenteeism. Hence,

*Proposition 2:* Hospitality organizations implementing human capital management will better curb the occurrence of presenteeism than their counterparts that are not implementing the same strategy.

### *Organizational Climate and Presenteeism*

Workplace stress and other work-related stressors have been identified in literature as predictor of presenteeism. For instance, the findings of Neto et al., (2017) and Karatza, Prezerakos, Zyga, & Tziaferi, (2016) indicated that bullying in the workplace usually result in negative perception of the workplace and impacts the wellbeing of employees who might therefore be losing their productive energy to presenteeism. In similar studies, Janssens et al., (2016) and Conway, Clausen, Hansen, and Hogh, (2016) found that the frequency occurrence of presenteeism is a function of workplace mistreatment such as bullying and incivility.

Following these outlined research findings, it is therefore important for top managers and supervisors who will appreciate optimal return or inputs from their employees to create a working atmosphere that is conducive for employees' growth, performance and wellbeing. Organizational climate is the work atmosphere which has the potential of motivating and influencing the willingness of the employee to remain with an organization, particularly in service industries. It frequently represents the interface between organization and customers (Manning, Davidson, & Manning, 2005). Beyond its role in influencing employees' intent to remain or quit the organization, organizational climate has been found to be precursory to several other employees' behaviors and attitudes such as absenteeism, deviant behaviors, proactive customer service performance and organizational citizenship behavior (Kangas, Muotka, Huhtala, Mäkikangas, & Feldt, 2017; Lau et al., 2017; Li, Chiaburu, & Kirkman, 2017). Invariably, organization should create an inclusive climate that shuns mistreatment and encourages communication. Specifically, we posit that through its structure, culture and norms organizations can create a befitting climate that will deter bullying and promote employee trust. Thus the next proposition is developed as:

*Proposition 3:* Hospitality organizations with strong organizational structure, culture and norms that deters employees' mistreatment will effectively limit organizational loss to presenteeism.

### *Presenteeism, Talent Management, KMS, Human Capital and Organizational Climate*

Talent management is perhaps the most important tool that organizations often deploy for employee attraction and retention. In mainstream literature, talent management has been study from varieties of angles. In a meta-analytic study conducted by Thunnissen, Boselie, and Fruytier, (2013) using "talent" and "talent management" as keywords, the results indicated that talent management has not been the main focus of hospitality research. However, Dries, (2013) argued that "attracting and retaining talented people is becoming increasingly difficult as a result of

specific demographic and psychological trends”(Dries, 2013, p.273). Hence, Deery and Jago, (2015) in their work on revisiting talent management, work-life balance and retention strategies make the need to investigate issues relating to talent management such as emotional exhaustion, stress and personal employees’ dimension the focal point of their studies.

In relation to presenteeism, talent management’s importance is beyond just identifying, attracting and retaining talented employees but extend to understanding their personal concerns which may affect their wellbeing and thus, their perception of the job. As suggested by Barnes (2016), information gathering and analysis can be a crucial approach to managing the occurrence and effects of presenteeism in organizations. Although Barnes focused on information gathering through the use of technological innovations such as cloud-based systems, we argue that talent management can be a great avenue for organizations to elicit important information regarding their employees.

With the aid of functional knowledge management systems, information gathering, processing, use and storage is expected to be more accurate and effective.

As such, talent management may be a bridge that connect KMS, organizational climate and human capital management to presenteeism. Thus, we develop the next proposition as:

Proposition 4: Talent management mediates the relationship between presenteeism and (1) organizational climate, (2) human capital management, and (3) knowledge management.

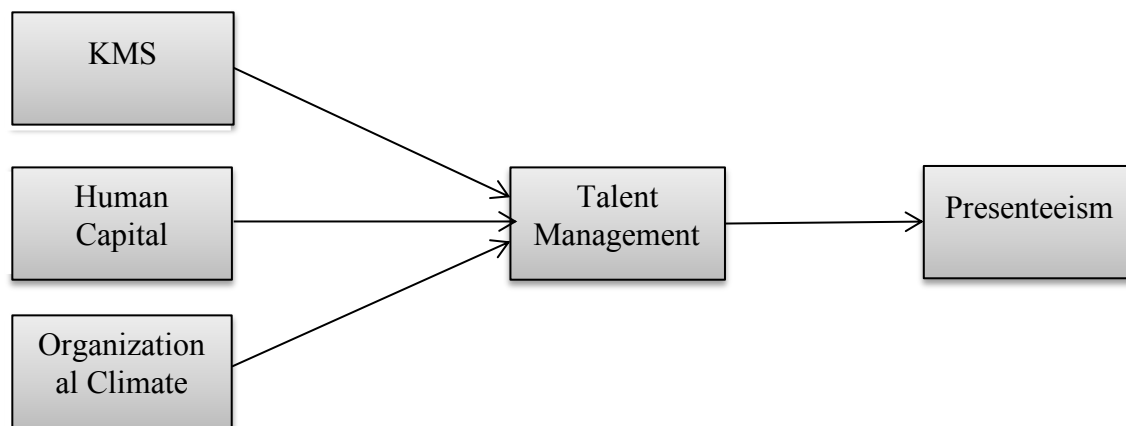

Figure 1. Conceptual model

## Conclusion

Presenteeism is a subtle but salient factor contributing significantly to productivity loss in organizations. Specifically, hospitality business which is characterized with high demand and low pay, it is expected that the pressure of the job and emotional stress from bad working environment may result in employees’ increasingly present but not being productive at work. To systematically examine key mechanisms delimited in the predominant theoretical framework that accounts for the complex relationships among knowledge management systems, organizational climate, human capital management and presenteeism, we propose a model that can bridge social psychological processes with organizational research on the global phenomenon of presenteeism (Cooper & Lu, 2016).



The current study provides a unique pathway for managing the effect of presenteeism in hospitality settings. Previous studies on employee relations and human resource management have often focused on the effects of organizations' HR practices in predicting employees on the job vis-à-vis of the job performance, attitudes and behaviors. However, as highlighted by Deery and Jago, (2015), there has been dearth of research focusing on talent management and its importance in employees' satisfaction and performance. Through our proposed model, hospitality firms can better manage their employees not only through computer programs by via emotional interactions that will communicate value, trust and openness in the organization thereby minimizing resource loss to presenteeism. Thus, this study contributes to the current body of knowledge on human related issues by:

Developing a model that integrates knowledge management, human capital management, organizational climate and talent management into the mechanism that effectively manage presenteeism in hospitality firm.

We also answer the question- how can presenteeism and its related cost to organization be minimized?

Our study only unveils the subtle effect of presenteeism but speaking out of it deleterious effect on organizational performance as many studies on the subject has been conducted mainly in the medical field.

## References

- An, M., & Noh, Y. (2009). Airline customer satisfaction and loyalty: impact of in-flight service quality. *Service Business*, 3(3), 293–307.
- Barnes, S. (2016). Presenteeism--how it can be managed and even used to the benefit of the unwell who want to work and the employer organization. *Strategic HR Review*, 15(2), 95–97.
- Cabello-Medina, C., López-Cabrales, Á., & Valle-Cabrera, R. (2011). Leveraging the innovative performance of human capital through HRM and social capital in Spanish firms. *The International Journal of Human Resource Management*, 22(4), 807–828.
- Conway, P. M., Clausen, T., Hansen, Å. M., & Hogh, A. (2016). Workplace bullying and sickness presenteeism: cross-sectional and prospective associations in a 2-year follow-up study. *International Archives of Occupational and Environmental Health*, 89(1), 103–114.
- Cooper, C., & Lu, L. (2016). Presenteeism as a global phenomenon: Unraveling the psychosocial mechanisms from the perspective of social cognitive theory. *Cross Cultural & Strategic Management*, 23(2), 216–231.
- Deery, M., & Jago, L. (2015). Revisiting talent management, work-life balance and retention strategies. *International Journal of Contemporary Hospitality Management*, 27(3), 453–472.
- Demerouti, E., Le Blanc, P. M., Bakker, A. B., Schaufeli, W. B., & Hox, J. (2009). Present but sick: a three-wave study on job demands, presenteeism and burnout. *Career Development International*, 14(1), 50–68.
- Dries, N. (2013). The psychology of talent management: A review and research agenda. *Human Resource Management Review*, 23(4), 272–285.
- Elmadağ, A. B., & Ellinger, A. E. (2017). Alleviating job stress to improve service employee work affect: the influence of rewarding. *Service Business*, 1–21.
- Fisk, G. M., & Neville, L. B. (2011). Effects of customer entitlement on service workers' physical and psychological well-being: a study of waitstaff employees. *Journal of Occupational Health Psychology*, 16(4), 391.
- Gustafsson, K., & Marklund, S. (2011). Consequences of sickness presence and sickness absence on health and work ability: a Swedish prospective cohort study. *International Journal of Occupational Medicine and Environmental Health*, 24(2), 153–165.
- Harrop, J. J. (2017). Assessment and recommendations for effective HR service delivery model implementation for organizations. *Middle East Journal of Business*, 12(1), 23–27.

- Janssens, H., Clays, E., De Clercq, B., De Bacquer, D., Casini, A., Kittel, F., & Braeckman, L. (2016). Association between psychosocial characteristics of work and presenteeism: a cross-sectional study. *International Journal of Occupational Medicine and Environmental Health*, 29(2), 331–344.
- Jiang, K., Lepak, D. P., Hu, J., & Baer, J. C. (2012). How does human resource management influence organizational outcomes? A meta-analytic investigation of mediating mechanisms. *Academy of Management Journal*, 55(6), 1264–1294.
- Kangas, M., Muotka, J., Huhtala, M., Mäkikangas, A., & Feldt, T. (2017). Is the ethical culture of the organization associated with sickness absence? A multilevel analysis in a public sector organization. *Journal of Business Ethics*, 140(1), 131–145.
- Karatzas, C., Prezerakos, P., Zyga, S., & Tziaferi, S. (2016). Workplace bullying and general health status among the nursing staff of Greek public hospitals. *Annals of General Psychiatry*, 15(1), 7.
- Kivimäki, M., Ferrie, J. E., Brunner, E., Head, J., Shipley, M. J., Vahtera, J., & Marmot, M. G. (2005). Justice at work and reduced risk of coronary heart disease among employees: the Whitehall II Study. *Archives of Internal Medicine*, 165(19), 2245–2251.
- Lau, P. Y. Y., Tong, J. L. Y. T., Lien, B. Y.-H., Hsu, Y.-C., & Chong, C. L. (2017). Ethical work climate, employee commitment and proactive customer service performance: Test of the mediating effects of organizational politics. *Journal of Retailing and Consumer Services*, 35, 20–26.
- Li, N., Chiaburu, D. S., & Kirkman, B. L. (2017). Cross-level influences of empowering leadership on citizenship behavior: Organizational support climate as a double-edged sword. *Journal of Management*, 43(4), 1076–1102.
- Lin, C., Yu-Ping Wang, C., Wang, C.-Y., & Jaw, B.-S. (2017). The role of human capital management in organizational competitiveness. *Social Behavior and Personality: An International Journal*, 45(1), 81–92.
- Manning, M. L., Davidson, M., & Manning, R. L. (2005). Measuring tourism and hospitality employee workplace perceptions. *International Journal of Hospitality Management*, 24(1), 75–90.
- Neto, M., Ferreira, A. I., Martinez, L. F., & Ferreira, P. C. (2017). Workplace bullying and presenteeism: the path through emotional exhaustion and psychological wellbeing. *Annals of Work Exposures and Health*, 61(5), 528–538.
- Parasuraman, A., Zeithaml, V. A., & Berry, L. L. (1985). A conceptual model of service quality and its implications for future research. *The Journal of Marketing*, 41–50.
- Surprenant, C. F., & Solomon, M. R. (1987). Predictability and personalization in the service encounter. *The Journal of Marketing*, 86–96.
- Taloyan, M., Aronsson, G., Leineweber, C., Hanson, L. M., Alexanderson, K., & Westerlund, H. (2012). Sickness presenteeism predicts suboptimal self-rated health and sickness absence: a nationally representative study of the Swedish working population. *PLoS One*, 7(9), e44721.
- Teng, C.-I., & Liu, T.-W. (2014). How do personality interactions affect service quality? the perspective of processing efficiency theory. *Service Business*, 8(2), 375–397.
- Thunnissen, M., Boselie, P., & Fruytier, B. (2013). Talent management and the relevance of context: Towards a pluralistic approach. *Human Resource Management Review*, 23(4), 326–336.
- Yang, C.-C., & Lin, C. Y.-Y. (2009). Does intellectual capital mediate the relationship between HRM and organizational performance? Perspective of a healthcare industry in Taiwan. *The International Journal of Human Resource Management*, 20(9), 1965–1984.
- Youndt, M. A., & Snell, S. A. (2004). Human resource configurations, intellectual capital, and organizational performance. *Journal of Managerial Issues*, 337–360.
- Zhou, Q., Martinez, L. F., Ferreira, A. I., & Rodrigues, P. (2016). Supervisor support, role ambiguity and productivity associated with presenteeism: a longitudinal study. *Journal of Business Research*, 69(9), 3380–3387.

## ***Part 7: Innovation & Entrepreneurship***

# Strategic Flexibility as a Key to Innovativeness: Theoretical Framework

Dmytro Shestakov

Kyiv-Mohyla Business-School, Ukraine

## Abstract

The article reveals the main strategic changes of the competitive environment, the necessity of flexibility in the new competitive conditions are determined. Flexibility in its various forms has long played an important role in the organizational change and strategy literature. The theoretical approaches to the definition of the concept of "flexibility", "strategy", "strategic flexibility" are revealed. Various kinds of flexibility of the company and levels of strategic flexibility are reviewed. With the changed dynamics in the new competitive landscape, firms face multiple discontinuities that often occur simultaneously and are not easily predicted. The article substantiates that managers and government policy makers are encountering major strategic discontinuities that are changing the nature of competition. Firms must be flexible to manage discontinuities and unpredictable change in their environments. Flexibility has been a characteristic of an organization that makes companies less vulnerable to unforeseen external changes or puts it in a better position to respond successfully to change. Strategic flexibility may increase innovation performance of a firm.

**Keywords:** globalization, strategy, flexibility, strategic flexibility

## Introduction

Despite the importance of strategies for organizational success and despite decades of research, academics have not yet agreed on what strategy really is and various approaches of strategy have evolved over the years (Das, 1995).

In 1980 Porter's seminal work "Competitive Strategy" was published. In this book Porter took a more deterministic view of strategy that still dominates the strategic management literature today. He refers to "strategic choice" where the company has a finite selection of strategies to choose from, based upon study of its external environment. Porter also supports a "single best option" approach to strategy. This was based upon the need to make strategic choices between options having varying degrees of strategic and financial risk (Sushil X. , 1997).

According to (Sarbah & Otu-Nyarko, 2014) strategy provides the systematic way for identifying and evaluating factors external to the firm and fixing them with the organization's abilities.

Strategy formulation consists of two basic components one is situation analysis which is the process of finding a strategic fit between external opportunities and internal strengths while working around external threats and internal weaknesses (Hadighi & Mahdavi, 2011). And the other component is presenting strategies based on predetermined goals.

Early research about strategic flexibility includes (Gotcher, 1977) who suggested that long range planning required flexibility. Eppink related the term "adaptiveness" as the ability of the organization to respond to unforeseen change. He added: "...flexibility can be seen as a characteristic of an organization that makes it less vulnerable to unforeseen external changes or

puts it in a better position to respond successfully to such a change.” (Eppink, 1978). Eppink argued strategic flexibility was necessary to compensate for strategic changes in the “indirect” environment of the company that reached it via the components of its “direct” environment. He suggested such changes required a high degree of unfamiliarity and could therefore be very dynamic and urgent (Sushil X. , 1997).

Shimizu and Hitt argue that maintaining strategic flexibility is one of the most important yet most difficult tasks of managers and companies in dynamic environments (Shimizu & Hitt, 2004). An effective strategy allows managers to use their organization’s resources and capabilities to exploit opportunities and limit threats in the external environment in order to achieve competitive advantage (Quaye, Osei, Sarbah, & Abrokwah , 2015).

The conceptualization of strategic flexibility has been described and studied by numerous authors. As a result of these studies notion of strategic flexibility is the ability to do something other than that which had been originally intended (Evans, 1991)

## **Literature Review**

In today's conditions the new competitive landscape, driven by the technological revolution and significant globalization, is moving towards hyper competition.

The time frames of all strategic actions are being reduced; firms exist in highly turbulent environments that produce disorder, disequilibrium and substantive uncertainty.

Some of the most important strategic discontinuities of the competitive environment include:

- Elimination of industry boundaries.
- Fewer distinctions between industrial and service businesses.
- Major advances in logistics, computer aided design and communication.
- Opening of global markets.

Firms encounter these changes at the same time they are experiencing intense foreign competition in domestic markets. These changes rival those experienced with the industrial revolution and their impact is likely to rival that of the major advances of the light bulb, telephone, printing press, and the personal computer.

In such conditions it is more complicated for companies to maintain their competitiveness. Firms have to create innovative products and services of high quality and at low prices to satisfy increasingly informed customers with distinct needs. Managers are motivated to reduce the uncertainty by identifying new sources of competitive advantage.

It requires that they:

- Continue to develop and use innovative technology.
- Actively participate in global markets.
- Structure themselves to gain advantages.
- Develop and maintain strategic flexibility.

- Build a long-term vision that allows managers to balance short-term performance with long-term needs.

Firms must develop the ability to effectively navigate in the new competitive landscape. To do so, requires significant revision of standard management thinking and strategic process.

The processing and communication of information have facilitated the rapid diffusion of technology as well as produced an information rich, computational rich and communications rich organizational environment. These changes have shortened product life cycles, made patents less effective in protecting modern technology and thus less useful, and reduced the time required to develop and bring new products to the market.

These conditions call for firms to develop radically enhanced techniques for processing and integrating information and also provide a catalyst for further technological development. An organizational learning becomes critical importance for the firm to gain and maintain a competitive advantage.

Random events cannot be forecasted. Companies need to be flexible to control unpredictable changes in their competitive environment. The disequilibrium caused can only be managed at the time it occurs. The enhanced competition and increasing demands from consumers require from firms dynamic core competences – act rapidly in response to competitors or to proact by beating competitors to the market (Das, 1995). These require flexible strategy that allows firms to reduce periods of instability by making rapid and effective changes.

Dynamic core competences help firms remain flexible and able to respond quickly to unpredicted and unexpected changes in the environment and partially shape the environments in which they operate and compete. If firms do not continue to invest in and develop their core competences over time, the competences may become outdated, and limit future strategic alternatives for the firm (Das, 1995).

Companies use strategies as a tool for planning common actions to manage environmental changes (Sushil K. , 2000; Markides, 2004). Formulating and implementing appropriate organizational strategies are nowadays recognized as one of the most crucial determinants of successful management and business. Since environmental changes and uncertainty have significant influence on managers' and organizations' ability to formulate and implement successful strategies, it is important for organizations to handle changes by possessing flexibility.

The environment includes external factors such as regulatory, economic, political, and social changes affecting the company's primary and secondary task environments (Achrol & Kotler, 1999). Changes in the company's environment resulted in the reassessment of strategy among a given array of strategic alternatives (Porter, 1980; Porter, 1985; Harrigan, 1986; Parnell, 2003). Thus, strategic choice was based on how a company evaluated its position in the environment.

Today there are three main fundamental approaches to definition of strategy: strategy as plan, strategy as pattern and strategy as practice (Sushil K. , 2000).

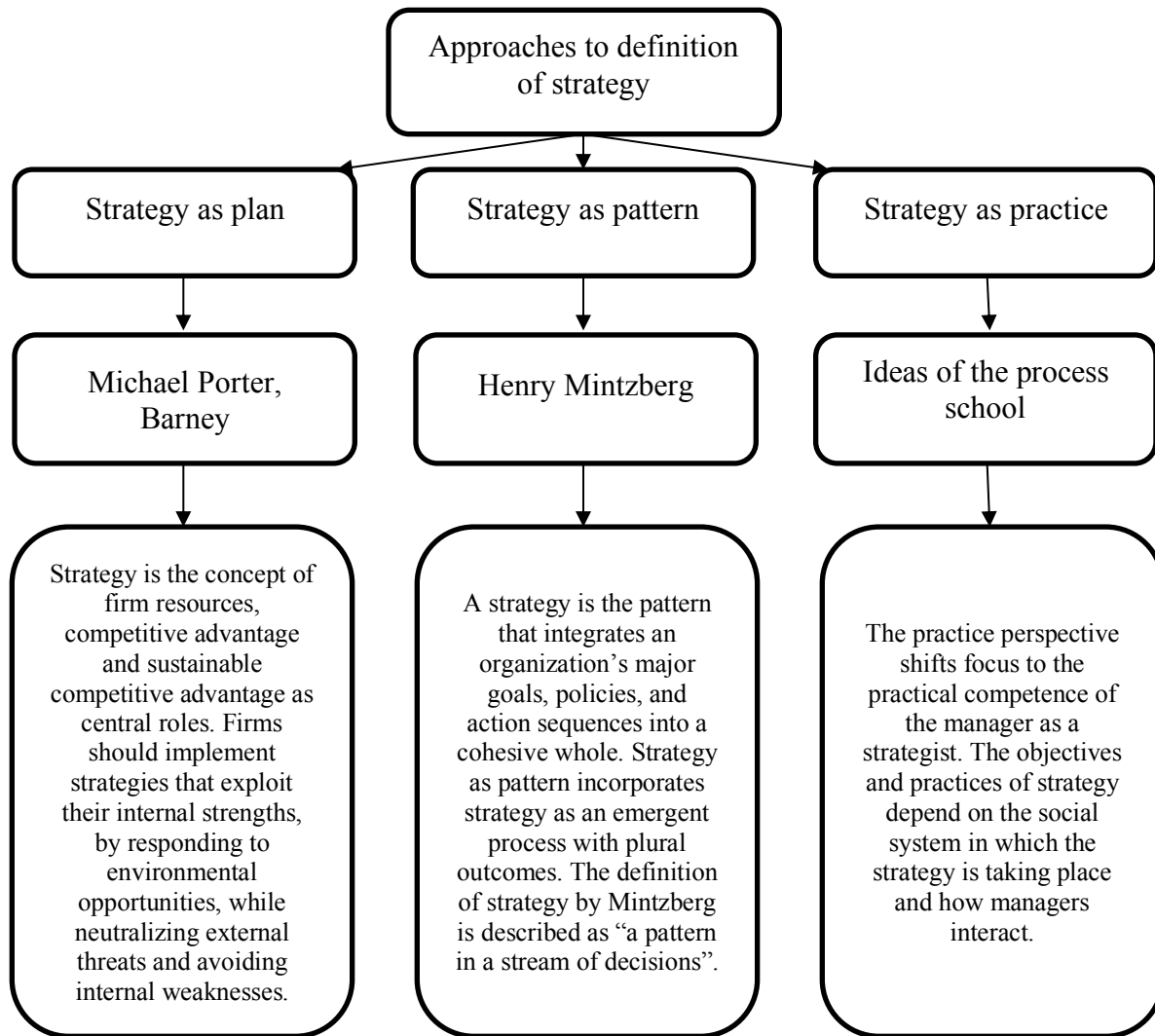

Figure 1. Approaches to strategy definition

Burnes identified three types of strategy according to the level of strategic decision making (Burnes, 1992):

- Corporate Level Strategy - concerned with the direction, composition and coordination of the various business units within a large and diversified organization.
- Business Level Strategy - related to the operation and direction of individual business units within a group of companies.
- Functional Level Strategy - related to individual business functions (Sushil X. , 1997).

Corporate level strategy deals with the question in what business a company shall compete. Business level strategy concerns the question of how to attain a position to achieve its business objectives. Operational level strategy concerns how individual business functions manage a unit's operations (Sushil K. , 2000).

For firms to manage uncertainties, strategies are not enough. It is necessary to achieve flexibility in different operations and organizational processes. As it enables organizations to manage changing environments, understanding flexibility is critical (Sushil K. , 2000).

Flexibility is the ability to do something other than originally intended. It is a response to environmental change and uncertainty (Sushil K. , 2000). There are many interpretations of the scientific concept of flexibility.

**Table 1.** Scientists Approach to the Definition of “Flexibility”

Author	Definition of “flexibility”
(Eppink, 1978)	Flexibility is a characteristic of an organization that makes it less vulnerable to unforeseen external changes or puts it in a better position to respond successfully to such a change
(Aaker & Mascarenhas, 1984)	Flexibility is the ability of the organization to adapt to substantial, uncertain and fast-occurring environmental changes that have meaningful impact on the organization’s performance.
(Harrigan, 1985)	Flexibility is the ability of firms to reposition themselves in a market, change their game plans, or dismantle their current strategies when the customers they serve are no longer as attractive as they once were.
(Bahrami, 1992)	Flexibility is the ability to precipitate intentional changes, to continuously respond to unanticipated changes, and the ability to adjust to unexpected consequences of predictable changes
(Das, 1995)	Flexibility is the ability of an organization to respond to changes in the environment in a timely and appropriate manner with due regard to competitive forces in the marketplace.
(Hitt, Keats, & DeMarie, 1998)	Flexibility is the capability of the firm to proact or respond quickly to changing competitive conditions and thereby develop and maintain competitive advantage.
(Volberda, 1996)	Flexibility is the degree to which an organization has a variety of managerial capabilities and the speed at which they can be activated, to increase the control capacity of management and improve the controllability of the organization.

Thus, scientists have multiple connotations with the notion of “flexibility” as per the situation; some of the important ones are:

- Adaptiveness to the changes in the environment.
- Adjustment to situation.
- Agility in action.
- Amiability in relationships.
- Autonomy in functioning.
- Balance in competing opposites.
- Broadening of mind.
- Compromising for betterment.
- Contingency in planning.

It also implies customizing solutions, elasticity under tension, freedom of thought and expression, informal attitude, liberalization from controls, openness in thinking, resilience in implementation, responsiveness to customers’ requirements, variability in parameters and specifications, mobility



in transactions, and versatility in solutions and operations (Alarcon & Caruso, 2013; Sushil K. , 2014).

Flexibility is created in enterprises via a variety of new strategic initiatives so as to adapt and respond to global change. It is imperative that maturity models of enterprises should define flexibility of various types at different maturity levels. This will facilitate organizations to become more competitive and to effectively manage risk of uncertainty in business environment (Hatch & Zweig, 2001).

Hatch and Zweig emphasize the flexibility advantages of small companies. The lack of highly formalized systems and processes results in reduction of time needed for decision-making and implementation. This allows them to respond promptly to market development and adjust their competitive position. The potential for rapid change and evolution offers them a chance to gain competitive advantage and survive (Shimizu & Hitt, 2004; Georgzén & Palmér, 2014).

There are various types of flexibilities in an enterprise, such as strategic flexibility, organizational flexibility, financial flexibility, manufacturing flexibility, information systems (IS) flexibility, marketing flexibility, operational flexibility, and technology management flexibility.

Under each category, there are many types of flexibilities. For example, the manufacturing flexibility encompasses product flexibility, process flexibility, volume flexibility, routing flexibility, tooling flexibility, labor flexibility, static flexibility, dynamic flexibility, and so on (Sushil X. , 1997).

Financial flexibility would incorporate outlay flexibility, investment flexibility, flexible budgets, and flexible exchange rates to hedge the risk and uncertainty around.

The organizational flexibility deals with flexible structure and flexible work processes like flexi-time and flexi-place (Sushil X. , 1997).

In theory, it becomes easy to distinguish and classify the different types of flexibility. In reality they can have overlapping characteristics.

**Table 2.** Types of Organization's Flexibility

<b>Author</b>	<b>Types of flexibility</b>
Eppink	Operational, competitive and strategic (Eppink, 1978)
Krijnen	Strategic, organizational and operational (Krijnen H. , 1984)
Volberda	Operational, structural and strategic (Volberda, 1996)

Depending upon the variety and speed combination, the flexibility could be of four types, namely:

- Static flexibility (low variety-low speed).
- Operational flexibility (low variety-high speed).
- Structural flexibility (high variety-low speed).
- Strategic flexibility (high variety-high speed) (Sushil K. , 1999).

Allowing flexibility to pervade every level of the organization becomes a vital component for competitiveness (Sushil K. , 2000).

Strategy formulation requires careful analyses. But forecasts of market development and environmental changes are burdened with high-level uncertainty (Shimizu & Hitt, 2004). Raynor suggests that one of the ways to cope with the paradox of strategy is to implement strategic flexibility in a proactive manner, as a set of ex ante actions (Cingoz & Akdogan, 2013).

Strategic flexibility in particular has gained significant importance in management practice and literature. Eppink in his research of flexibility stated that strategic flexibility as a concept will grow significantly in the future (Eppink, 1978).

Strategic flexibility is treated as more important among the other aspects of flexibility because it is a long-term perspective of flexibility. It is emphasizing a firm's managerial capability to identify, generate and maintain real options in positioning itself in response to environmental changes and uncertainties (Eppink, 1978).

Strategic flexibility is a concept that is associated with environmental dynamism, the rate and the unpredictability of changes in a firm's external environment. Firms with strategic flexibility tend to effectively and successfully manage economic and political risks by responding in a proactive manner to market threats and opportunities (Zheng Zhou & Wu, 2010).

Developing strategic flexibility is a beneficial practice for companies. Reassessing strategies in a flexible manner provides firms with possibilities for successful businesses and simultaneously creating flexible operations to manage a changing environment.

Strategic flexibility suffers from the same inconsistency in conceptualization just as the broader concept of flexibility. There is no unified definition or conceptualization exists of strategic flexibility among scientists (Sushil K. , 2000).

Strategic flexibility suggests the ability to take some action in response to external environmental changes and thus can be viewed as a strategic capability. Consequently, strategic flexibility can be conceptualized in two ways:

- Variation and diversity of strategies.
- The degree at which companies can rapidly shift from one strategy to another (Sushil X. , 1997).

Other terms that offer a similar conceptualization include the terms “strategic maneuverability” (Sushil K. , 2014), “organizational flexibility” (Volberda, 1996), and “dynamic capabilities” (Teece, Pisano, & Shuen, 1997). (Aaker & Mascarenhas, 1984) argued “organizational flexibility” was a strategic option that could be exercised by an organization.

The term strategic flexibility can be applied at two levels:

- At the level of the firm, where it is used to denote the ability of firms to respond and successively adapt to environmental change (Evans, 1991).
- At the level of decision makers, where it is the extent to which new and alternative options in strategic decision making are generated and considered (Aaker & Mascarenhas, 1984).

These two applications are not mutually exclusive, because the creation of different options by decision makers is a prerequisite for firms adapting to environment change (Sanchez , 1995; Sharfman & Dean Jr, 1997). In other words, for strategic flexibility to exist at the level of the firm, decision makers themselves must possess capabilities for strategic flexibility (Hadighi & Mahdavi, 2011).

**Table 3.** Scientists' Approaches to Definition of “Strategic Flexibility”

Author	Definition of “strategic flexibility”
Evans, Bahrami, Sanchez	Strategic flexibility is the ability to precipitate intentional changes and adapt to environmental changes through the continuous rethinking of current strategies, asset deployment, and investment strategies (Evans, 1991; Sanchez , 1995).
Hitt	Strategic flexibility is the capability of the company to proact or respond quickly to changing competitive conditions and thereby develop and maintain competitive advantage (Hitt, Keats, & DeMarie, 1998; Radomska, 2015).
Sanchez	Strategic flexibility is the flexibility of the resources available to the company (resource flexibility) and the company’s flexibility in applying those resources to alternative courses of action (coordination flexibility) (Sanchez , 1995).
Evans	Strategic flexibility is a function of the event that impacted on the company, by necessity of choice, being used to denote the company’s deliberate or emerging capabilities to maneuver offensively or defensively (Evans, 1991)
Anderson	Strategic flexibility is a company’s ability to restructure itself internally as well as its relationship with the external environment including competition originating from almost anywhere, even from outside a company’s industry (Sushil X. , 1997).
Volberda, Rutges	Strategic flexibility – is a non-routine steering capacity, managerial capabilities related to the goals of the organization or the environment (Sushil X. , 1997).
Grewal, Tansuhaj	Strategic flexibility - is the organizational ability to manage economic and political risks by promptly responding in a proactive or reactive manner to market threats and opportunities (Grewal & Tansuhaj, 2001)
Johnson	Strategic flexibility – is the firm’s capabilities to generate firm-specific real options for the configuration and reconfiguration of appreciably superior customer value propositions (Johnson, Lee, Saini, & Grohmann, 2003)
Combe, Greenley	Strategic flexibility is an organization’s capability to identify major changes in the external environment, to quickly commit resources to new courses of action in response to change, and to recognize and act promptly when it is time to halt or reverse such resource commitments (Markides, 2004).
Kapasuwan	Strategic flexibility is a firms’ capability to realize and generate options and to position/reposition themselves in response to environmental changes in a reactive or proactive manner (Kapasuwan, Rose, & Tseng, 2007)

This internally driven strategic flexibility split into three levels is similar to (Krijnen H. , 1979) division of the strategic decision-making process:

- The strategic level (strategic policy, economic, social goals, and product market mix).
- The organizational level (organizational structure, decision making, and communication processes).
- The operational level (production volumes) (Krijnen H. , 1984).

Sanchez argued that two critical components of strategic flexibility were “resource flexibility” and “coordination flexibility”, which are both controlled from a company’s internal environment (Sanchez , 1995). So, an inward focus is directed on the company’s internal environment, and

different strategic options are possible depending on the nature of the change and the internal company influence.

Combining strategy and flexibility, (Roberts & Stockport, 2014) and (Sharma, Sushil, & Jain, 2010) identified that strategic flexibility has three levels of strategy analysis:

- High-level - is the organizational direction.
- Medium-level - is the organizational structure.
- Low-level - is operations related to individual business units.

(Burnes, 1992) and (Johnson G. , 2011) emphasized the need for analyzing strategies on various levels in organizations and the need for integration between them (Sushil K. , 2012).

High-level strategic decision-making has been named corporate level or organizational direction. This concept aims at explaining the overall corporate strategy e.g. direction, composition and coordination of the firm (Burnes, 1992).

Based on (Sharma, Sushil, & Jain, 2010; Burnes, 1992; Roberts & Stockport, 2014) classifications, high-level strategic flexibility in this study concerns changing of overall strategies, renewal and diversity of products and services, switching to new markets or technologies and directions (Cingoz & Akdogan, 2013).

Medium-level decision-making has been referred as organizational level, competitive level, organizational structure or business level (Volberda, 1996; Eppink, 1978; Sharma, Sushil, & Jain, 2010; Burnes, 1992). From a contemporary perspective, organizational flexibility concerns activities such as co-ordination flexibility, locational flexibility and resource flexibility (Hadighi & Mahdavi, 2011; Ruiner, Wilkens, & Küpper, 2013). Measurements for medium-level strategic flexibility can be summarized as: competences, decision and communication processes, innovation, how to tackle competition and other value-adding activities (Sushil K. , 2000).

Low-level is more or less jointly termed operational level (Georgzén & Palmér, 2014; Krijnen H. , 1984; Volberda, 1996; Sushil K. , 2012). According to (Burnes, 1992), the operational level strategy concerns strategic decisions regarding processes, people and resources. Firms can be perceived to be flexible when they with ease can change production to match fluctuations, efficiently shift production between locations, withdraw production from unprofitable markets, customize products or move resources to profitable markets (Krijnen H. , 1984; Sharma, Sushil, & Jain, 2010; Kandemir & Acur, 2012). Measurements for low-level strategic flexibility can be summarized as: changing production volumes connected to supply and demand fluctuations, allowing customization of products, easily shifting production between locations and allowing people in a decentralized structure to make operational decisions (Sushil K. , 2000).

The resource-based view focuses on those assets and capabilities that provide competitive advantage. Strategic flexibility depended jointly on resource flexibility and the company's flexibilities in applying those resources to alternative courses of action (Sushil X. , 1997).

Within the competence-based view of the company, strategic flexibility characterizes the ability to respond advantageously to a changing environment. The competence-based view of the company came to the forefront of strategic management literature with Prahalad and Hamel's

“Core Competence” (Prahalad & Hamel, 1990). Core competences were identified as “...the collective learning in the organization, especially how to coordinate diverse production skills and integrate multiple streams of technologies.” (Sushil X. , 1997).

## **Conclusions**

In a stable environment, traditional management concept helps organizations to attain success. But it is limited to prepare organizations for uncertainty. As an alternative approach to managing for an uncertain future, new management theory and practice have begun to focus on developing on organizations` strategic flexibility.

Flexibility can be seen as a characteristic of an organization that makes it less vulnerable to unforeseen external changes or puts it in a better position to respond successfully to change. So, flexible firms exhibit both diversity in strategic responses and rapid shifts from one strategy to another (Zheng Zhou & Wu, 2010).

Increasing globalization is reshaping the competitive landscape and will continue to do so for the foreseeable future. The dynamism, uncertainty and unpredictability in the new competitive landscape require substantive changes in many firms to be competitive. The most important attribute that firms must achieve to operate effectively in the new competitive landscape is that of strategic flexibility (Das, 1995).

Managers constantly face uncertainty in terms of rapidly changing economic and political trends, increasing global competition, shortening technology cycles, transformations in societal values, and shift in customer demands. A firm`s ability to adapt quickly to such conditions is crucial to its success in obtaining and maintaining sustainable competitive advantages (Zheng Zhou & Wu, 2010).

A firm has to develop flexible capabilities for speed and surprise. These capabilities derive from broad knowledge bases, generalizable resources, and core competencies that can be applied in various ways (Volberda, 1996).

The various definitions of strategic flexibility have tended to reflect the different perspectives taken by strategic management researchers. There are differences in both the meaning and application of the term. Strategic flexibility provides a means by which companies can become more successful. Thus, strategic flexibility can be described as the strategic choices available to a company and the company`s ability to take advantage of those choices (Sushil X. , 1997).

Strategic flexibility enables firms to lead or respond to change (Quaye, Osei, Sarbah, & Abrokwah , 2015; Najmaei & Sadeghinejad, 2009). Flexible firms rapidly shift from one strategy to another, become more proactive.

Strategic flexibility may improve to innovation performance of a firm in a dynamic environment. Strategic flexibility can influence innovation performance by providing more flexible processes and structure. Innovation is the most important source of competitive advantage (Zheng Zhou & Wu, 2010). This is because innovation can result in new products that better satisfy customer needs, can improve the quality of existing products, or can reduce the costs of making products that customers want (Hill & Jones, 2004).

Any definition of strategic flexibility must combine both the external and internal perspectives. Therefore, strategic flexibility is about:

- The ability to manage strategic risk.
- The ability to respond to environmental change, i.e., both opportunities and threats.
- The ability of a company to use its resources in both a proactive and a reactive way (Sushil X. , 1997).

Successful adaptation through strategic flexibility will likely generate superior performance, exacerbating the imitation problem for competitors. Consequently, it is becoming increasingly important for decision makers to possess the capabilities for strategic flexibility in its various forms (Hadighi & Mahdavi, 2011).

Strategic flexibility is necessary for firms to break down the institutional routines. Because strategic flexibility emphasizes the flexible use of resources and reconfiguration of processes, it reflects one type of dynamic capability that enables firms to achieve a competitive advantage in turbulent markets. It is complementary organizational capability that can help the firm achieve the full potential of its key resources when used in combination (Krijnen H. , 1984).

## References

- Aaker , D., & Mascarenhas, B. (1984). The need for strategic flexibility. *Journal of Business Strategy* , 74-82.
- Achrol, R., & Kotler, P. (1999). Marketing in the Network Economy. *Journal of Marketing* , 146-163.
- Alarcon, J., & Caruso, J. (2013). Put Some Flexibility into Your Planning. *Pennsylvania CPA Journal* , 36-39.
- Bahrami, H. (1992). The emerging flexible organization: Perspectives from Silicon Valley. *California Management Review* , 33-52.
- Burnes, B. (1992). *Managing Change: A Strategic Approach to Organizational Development and Renewal*. London: Pitman Publishing.
- Cingoz , A., & Akdogan, A. (2013). Strategic flexibility, environmental dynamism, and innovation performance: An empirical study. *Procedia - Social and Behavioral Sciences* , 582-589.
- Das, T. K. (1995, March 1). Managing Strategic Flexibility: Key to Effective Performance. *Journal of General Management* , pp. 60-75.
- Eppink, J. (1978). Planning for Strategic Flexibility. *Long Range Planning* , 9-15.
- Evans, S. (1991). Strategic Flexibility for High Technology Manoeuvres: A Conceptual Framework. *Journal of Management Studies* , 69-89.
- Flexible systems management: An evolving paradigm 1997 *Behavioral Science* 259-275
- Georgzén, P., & Palmér, H. (2014). *Managing Strategy and Flexibility: A Trade-Off For Swedish Companies*. Uppsala University .
- Gotcher, J. (1977). Strategic Planning in European Multinationals. *Long Range Planning* , 7-13.
- Grewal, R., & Tansuhaj, P. (2001). Building Organizational Capabilities for Managing Economic Crisis: The Role of Market Orientation and Strategic Flexibility. *Journal of marketing* , 65-80.
- Hadighi, A., & Mahdavi, I. (2011). A New Model for Strategy Formulation Using Mahalanobis-Taguchi System and Clustering Algorithm. *Intelligent Information Management* , 198-203.
- Harrigan, K. (1985). Vertical Integration and Corporate Strategy. *The Academy of Management Journal* , 397-425.
- Hatch, J., & Zweig, J. (2001). Strategic flexibility: The key to growth. *Ivey Business Journal* , 44.
- Hitt, M., Keats, B., & DeMarie, S. (1998). Navigating in the new competitive landscape: Building strategic flexibility and competitive advantage in the 21st century. *Academy of Management Executive* .
- Johnson, G. (2011). *Exploring Strategy* .
- Johnson, J., Lee, R.-W., Saini, A., & Grohmann, B. (2003). Market-focused strategic flexibility: Conceptual advances and an integrative model. *Journal of the Academy of Marketing Science* .
- Kandemir, D., & Acur, N. (2012). Examining proactive strategic decision-making flexibility in new product development. *Journal of Product Innovation Management* , 608-622.

- Kapasuwan, S., Rose, J., & Tseng, C.-H. (2007). The Synergistic Effects of Strategic Flexibility and Technological Resources on Performance of SMEs. *Journal of Small Business & Entrepreneurship* , 257-272.
- Krijnen, H. (1979). Flexible Firm. *Long Range Planning* , 63-75.
- Krijnen, H. (1984). Organization Responsiveness. *International Studies of Management & Organization* , 64-90.
- Markides, C. (2004). What is Strategy and How Do You Know If You have One? *Business Strategy Review* , 5-12.
- Matching vertical integration strategies to competitive conditions 1986 New York John Wiley & Sons, Ltd.
- Najmaei, A., & Sadeghinejad, Z. (2009). How Does Knowledge Management Matter in Enterprise Strategic Flexibility? Multiple Case Study Approach Based on SMEs in Malaysia. *Ibima Business Review* .
- Parnell, J. (2003). *Strategic Management: Theory and Practice*. Dreamtech Press.
- Porter, M. (1980). *Competitive Strategy: Techniques for Analyzing Industries and Competitors*. New York: Free Press.
- Porter, M. (1985). *The Competitive Advantage: Creating and Sustaining Superior Performance*. New York: Free Press.
- Prahalad, S., & Hamel, G. (1990). *The Core Competence of the Corporation*. London Business School .
- Quaye, I., Osei, A., Sarbah, A., & Abrokwah, E. (2015). The Applicability of the Learning School Model of Strategy Formulation (Strategy Formulation as an Emergent Process). *Open Journal of Business and Management* , 135-154.
- Radomska, J. (2015). Strategic Flexibility of Enterprises. *Journal of Economics, Business and Management* .
- Roberts, N., & Stockport, G. (2014). Defining Strategic Flexibility. *The Flexible Enterprise, Flexible Systems Management* , 37-45.
- Ruiner, C., Wilkens, U., & Küpper, M. (2013). Ménage à trois: Die Relevanz des Kunden in der psychologischen Vertragsbeziehung bei projektformiger Wissensarbeit. *Zeitschrift für Personalforschung* , 354-372.
- Sanchez, R. (1995). Strategic Flexibility in Product Competition. *Strategic Management Journal* , 135-159.
- Sarbah, A., & Otu-Nyarko, D. (2014). An Overview of the Design School of Strategic Management. *Open Journal of Business and Management* , 231-249.
- Sharfman, M., & Dean Jr, J. (1997). Flexibility in Strategic Decision Making: Informational and Ideological Perspectives. *Journal of Management Studies* , 191-217.
- Sharma, M., Sushil, & Jain, P. (2010). Revisiting Flexibility in Organizations: Exploring its Impact on Performance. *Global Journal of Flexible Systems Management* , 51-68.
- Shimizu, K., & Hitt, M. (2004). Strategic flexibility: Organizational preparedness to reverse ineffective strategic decisions. *Academy of Management Executive* , 44-58.
- Shimizu, K., & Hitt, M. (2004). Strategic flexibility: Organizational preparedness to reverse ineffective strategic decisions. *Academy of Management Executive* , 44-58.
- Strategic management: An integrated approach 2004 Boston Houghton Mifflin
- Sushil, K. (2000). *Cornerstones of enterprise flexibility: strategic, organizational, financial, information systems and manufacturing flexibilities*. New Delhi: Vikas Publishing House.
- Sushil, K. (1999). *Flexibility in management*. New Delhi: Vikas Publishing House.
- Sushil, K. (2012). *Flowing stream strategy: leveraging strategic change with continuity*. New Delhi: Springer.
- Sushil, K. (2014). The Concept of a Flexible Enterprise. *The Flexible Enterprise, Flexible Systems Management* , 3-26.
- Teece, D., Pisano, G., & Shuen, A. (1997). Dynamic capabilities and strategic management. *Strategic Management* , 509-533.
- Volberda, H. (1996). Toward the Flexible Form: How to Remain Vital in Hypercompetitive Environments. *Organization Science* , 359-374.
- Zheng Zhou, K., & Wu, F. (2010). Technological Capability, Strategic Flexibility And Product Innovation. *Strategic Management Journal* , 547-561.

***Part 8: International Trade &  
Management***



# Firm's Competitiveness in Global Economy and Cost (Structure) Management

Mehmet Hanifi Ayboga<sup>1</sup>, Asaf Murat Altug<sup>2</sup>, and Ersem Karadag<sup>3</sup>

<sup>1</sup>School of Social Sciences  
Marmara University, Turkey

<sup>2</sup>School of Business  
Marmara University, Turkey

<sup>3</sup>School of Business  
Robert Morris University, USA

## Abstract

The notion of competitiveness is to present a state of being in an economy in the sense that an environment exists that can promote the activities of economic entities to achieve the potential to create value. Competitiveness can suggest the notion that there are winners and losers. Competitive forces drive firms to seek new areas of growth, with either portfolio expansion or penetration and expansion in new markets. Although the forces that weigh heavily on a firm are recognized, their influence in determining a firm's action in choosing a particular strategy is not well understood (Gehlhar et al., 2006). On the other hand firms either in local or international markets need to understand the product costs as well as other costs associated with marketing, transportation and other costs. To do so, the strategic cost management (SCM) is the tool that firms can utilize to stay competitive in the market. The cost management refers to a simultaneous focus on reducing cost and strengthening an organization's strategic position (Eldenburg & Wolcott, 2005, p. 9). Firms competing in international markets need to find a sustainable, long-term strategy, that is, a set of policies, procedures, and approaches to business to produce success. Finding a strategy begins with determining the purpose and long-term direction, and therefore the mission of the company.

**Keywords:** competitiveness, strategic cost management, cost analysis, value chain.

## Introduction

At its most basic level, an economic foundation of competitiveness relates to the ability of an economic entity to create value to achieve sustained growth. This necessarily involves the ability to manage assets and processes as the firm increases the value (or wealth) of its activity through growth and productivity (Gehlhar et al., 2006). Such improvements and global changes not only affected firms and enforce them to change their strategies, but also had direct impacts on the competitiveness of an economy as a whole. As firms increase their global competitiveness, the economic value created by those firms contribute to the success of a country's economy and increase a nation's standard of living.

The notion of competitiveness is to present a state of being in an economy in the sense that an environment exists that can promote the activities of economic entities to achieve the potential to create value. Competitiveness can suggest the notion that there are winners and losers. When products can be differentiated and markets can grow, competitiveness is not always a zero-sum game. From a policy perspective, there are interventions that can propel an economic entity to become and remain competitive. From a business policy perspective, investments in productive capacity and production potential are encouraged. From a government policy perspective,

interventions are intended (ostensibly) to promote a competitive environment to maintain a level playing field (or remedy information asymmetries due to market failure). These interventions can be regulatory in nature or can provide or support public infrastructure and capacity (Gehlhar et al., 2006).

According to the “House of Lords on Overseas Trade Committee” competitiveness is synonymous with a firm's long-run profit performance and its ability to compensate its employees and provide superior returns to its owners. The Competitiveness Advisory Group (1995) proposes that competitiveness entails "elements of productivity, efficiency and profitability." Competitiveness, however, "is not an end in itself or a target... [but] a powerful means to achieve rising living standards and increasing social welfare -a tool for achieving targets". Accordingly, international competitiveness is achieved, "by increasing productivity and efficiency in the context of international specialization, [this is so, because] competitiveness provides the basis for raising peoples' earnings in an non-inflationary way." In short, as the World competitiveness Yearbook (IMD World Competitiveness Center, 2014) highlights, prosperity is the fundamental outcome of international competitiveness.

#### *Traditional Cost Management and Strategic Cost Management*

Cost management refers to a simultaneous focus on reducing cost and strengthening an organization's strategic position (Eldenburg & Wolcott, 2005, p. 9). For an effective cost management cost analysis is performed at product level and firm level. Cost analysis traditionally is viewed as the process of assessing the financial impact of alternative managerial decisions. Cost analysis is a broader contexts and cost data is used to develop superior strategies en route to gaining sustainable competitive advantage. The complexity of the cost structure of a firm can lead to a long way in creating the competition strategy. In firms' accounting function exists primarily to facilitate to development and implementation of business strategy (Shank & Govindarajan, 1993, p. 6). In the strategic cost management (SCM) framework, managing cost effectively requires a broad focus, external to the firm (Porter, 1998; p.43). Porter has called this focus “the value chain” (Altug, 2016, p. 129). Many managers view cost too narrowly and concentrate on manufacturing only.

Successful cost leaders draw cost advantage from throughout the value chain. The value chain for any firm in any business is the linked set of value-creating activities all the way from basic raw material sources for component suppliers through to the ultimate end-use product delivered into the final consumers' hands. This focus is external to the firm, seeing each firm in the context of the overall chain of value-creating activities of which it is only a part, from basic raw material components to end use consumers (Shank & Govindarajan, 1993, p. 13, 14).

In SCM, the role of cost analysis differs in important ways depending on how the firm is choosing to compete. Following Porter's (1980) delineation of basic strategic choices, a business can compete either by having lower costs (cost leadership) or by offering superior products (product differentiation). That these two approaches demand very different conceptual frameworks and has been widely accepted in the strategy literature. In strategic cost management it is acknowledged that cost is caused, or driven, by many factors that interrelated in complex ways. First category is “structural cost drivers”. From this perspectives there are at least five strategic choices by the firm, as follows (Shank & Govindarajan, 1993, p.19).

- *Scale*: how big an investment to make in manufacturing, in R&D, and in marketing resources.
- *Scope*: degree of vertical integration. Horizontal integration is more related to scale.
- *Experience*: how many times in the past the firm has already done what is doing again.
- *Technology*: what process technologies are used at each step of the firm's value chain?
- *Complexity*: how wide a line or products of services to offer to customer.

Second category of cost drivers, “*executional drivers*”, are those determinants of firm's cost position that hinge on its ability to execute successfully.

The list of basic executional drivers include at least the following (Shank & Govindarajan, 1993, p. 22):

- *Work force involvement* (participation) - the concept of work force commitment to continual improvement
- *Total quality management* (beliefs and achievement regarding product and process quality)
- *Capacity utilization* (given scale choices on plant construction )
- *Plant layout efficiency* (how efficient, against current norm, is the layout?)
- *Product configuration* (is the design or formulation effective?)
- *Exploiting linkages with supplier and or customers*, per firm's value chain

While it may not always be true that a higher level of these *executional factors improves cost position*. Operationalizing each of these drivers also involves specific cost analysis. Many strategy consultants maintain that the strategic cost analysis field is moving very quickly towards executional drivers because the insights from analysis based on structural drivers too often old fashioned.

### *Global Competitiveness*

A firm by finding a sustainable, long-term strategy, that is, a set of policies, procedures, and approaches to business to produce success. Finding a strategy begins with determining the purpose and long-term direction, and therefore the mission of the company. The mission is developed into specific performance objectives, which are then implemented by specific corporate strategies, that is, specific actions to achieve the objectives (Blocher et al., 1999, p. 28). Firms in the contemporary business environment use strategic management to focus primarily on strategic measures of success, many of which are non-financial measures of operations, such as market share, product quality, customer satisfaction, and growth opportunities (Blocher et al., 1999, p. 29). Business strategy literature provides a number of models for firm's strategy. A well-known model is provided by the five forces model and suggested by Porter (1998, p.35) which highlights;

- Rivalry among existing firms,
- Threat of new entrants,
- Threat of substitute products or services,
- Bargaining power of suppliers,
- Bargaining power of buyers.

Porter's 'five forces' of competition can be used to examine and analyze the competitive structure of an industry by looking at five forces of competition that influence and shape profit potential. Furthermore, Porter's 'five forces' of competition have become a central concept to business theory.

An alternative model suggested by Kay (1995), presents the notion of sustained competitive advantage in organizations obtained through (a) relational architecture, (b) reputation, (c) innovation and (d) strategic assets. At the core of Kay's model is the resource based theory of the firm which focuses on the internal attributes or the resources and capabilities of the firm where, in order for the resources and capabilities of a firm to provide superior performance. Kay states that organizations have a strong architecture where there is an expectation of long-term relationships both within the firm and among its members, a commitment to sharing the rewards of collective achievement and a high but unstructured degree of informality. He contends that this architecture adds value to individual contributions of its members through the creation of organizational knowledge, through the establishment of a cooperative ethic within the organization and by the implementation of organizational routines. Reputation enables a company to charge higher prices, or gain a larger market share at competitive price for functionally equivalent product. Innovation and being the first in the market place is a very strong source of competitive advantage. Firms find it very difficult, however, to sustain this advantage because of the potential for replication, but strategic assets which are more difficult to replicate.

A new theory of competition has been proposed in which "lean manufactures become locked in a head to-head race to create most innovative products at lowest price". This is described as a "confrontation strategy" (Altug, 2014, p. 65) in contrast to the generic strategy of the low-cost producer and differentiation. But Porter argued that (Porter, 1996, p. 62), operational effectiveness has replaced strategy at the forefront of management's concern and so attention has been refocused on the main components of strategy: performing unique activities; choosing a strategic position.

Two of the critical determinants of competitiveness in an economy are "*productivity improvements*" and "*technological innovations*" (Tyson, 1988, p. 97). When inputs become more productive, cost decline and producers can pay higher wages and charge competitive prices without sacrificing profits. Behind productivity improvements, in turn, lie both human and technological forces (Tyson, 1988, p. 97). Managerial and labor skills foundation for productivity performance - the better trained and more flexible the work force. Technological improvements also directly affect the competitiveness. Improvements in product quality or serviceability and product innovations are often. A central goal of a government policy toward the economy is to deploy a nation's resources (labor and capital) with high and rising level of productivity (Romano, 2006, p.617). To achieve productivity growth, an economy must be continually upgrading. This requires relentless improvement and innovation in existing industries and the capacity to compete successfully in new industries. Government's aim should be to create an environment in which firms can increase productivity and innovation by introducing more sophisticated technology and methods to (i) upgrade competitive advantages in established industries and (ii) develop the capacity to compete successfully in new industries (Porter, 1998, p. 616,618).

The scope for competition is no longer limited by national boundaries nor by the definition of a particular industrial sector hence the term "*global*". Competition, is about internalizing on a worldwide scale key assets such as knowledge, finance, production experience and market access

that can lead to the development and to the effective commercialization of a wide variety of products and services (Ernst & O'Connor, 1989, p.25). Government policies that succeed are those that create an environment in which firms can gain competitive advantage (Shenkar, et al., 2014, p.182). Government's most powerful roles are indirect rather than direct ones. State/ government policies can create competitiveness at both the macroeconomic and the microeconomic levels (Tyson, 1988, p.97).

At the macroeconomic level, policies can affect competitiveness over time by influencing the quantity and quality of labor, capital, and technology and should also support the ability of the nation's firms to enter new industries where higher productivity can be achieved than in position ceded in less productive industries and segments (Porter, 1998, p.128). Skill shortages in a nation's workforce can act as barrier to the introduction of new technologies and lead to reduction of a nation's competitiveness (Foley, et al., 1993, p.131). Skilled workforce associated with new technologies can be divided broadly into three group. These are (a) professional scientists/engineers, (b) technicians and (c) craft workers. Skill shortages act as constraint on adaption new technologies in local labor markets.

*The public-private (P-P) partnership* describe cooperative venture between the state and private business which is provide government support for firm competitiveness. And many type of public-private technology partnerships have been implemented, direct public funding of industry-led R&D projects, to public funding of private research consortia (Stiglitz & Wallsten, 2000, p. 38). At the microeconomic level, government using policy to create competitive advantage at the economy-wide level, government can use policy to create competitive advantage in individual industries or activities. Government policy influences firm strategy, structure, and rivalry, through such devices as capital market regulations, tax policy, antitrust law (Porter, 1998, p. 128).

### *Strategic Trade Theory*

Traditionally competition policy and international trade policy have been treated as separate fields despite the fact that they are closely related. Whilst the classical and neoclassical trade theory has been developed on the premise of "*perfect competition*" prevailing on all markets, the theory of strategic trade policy took cognizance of numerous markets being served by "*oligopolies*" (Neuman, 2001, p. 8). New trade theory has concentrated on demonstrating that under certain conditions, national policies to promote or protect domestic producers in international competition can improve national welfare. There are two different type of condition that give rise to result of this kind (Tyson, 1988, p.111).

- First, industry that are "*imperfectly competitive*", often as result of economies of scale, earn higher returns than those available rest of economy and national welfare may be improved by government policies to win larger market shares for domestic producers in World market.
- A second, conditions that provide *externality* or *spillover effects*. Certain industries may be more important than others because they generate benefits for the rest of economy. And governments' policy to promote them can improve welfare by fostering these spillover effects. The industries are defined "*strategic*". Government policy creates advantage at the micro level has focused on high technology sector.

Each of the firms continually seeks to find competitive advantage and recognize that the markets it sells are highly competitive. The degree of competition they face relates not to the number of rivals against which they compete but rather to the ever present possibility that their rivals may innovate and gain a decisive cost or product- quality advantage (Metcalf & Boden, 1993, p. 83).

*Causes of International Collaboration: Growing Costs, Entry to the New Technology and Foreign Markets*

Recently tendency of firms to *clusters, strategic alliances, cooperative R&D programs, acquisition in foreign countries and constellation* in distinct communities about the extent and pace at which technological knowledge diffuses across national boundaries (Tayyeb, 2001, p. 1).

“*Alliance*” is broad term capturing many inter-firm cooperation that go beyond mere market transactions. It includes “*vertical*” alliance between buyers and suppliers (subcontracting). “*Horizontal*” alliance between competitors, and “*diagonal*” alliances between firms in different industries. It covers the whole range of forms from incidental cooperation between independent firms, through licensing, more systematic and lasting forms of cooperation, equity swaps and equity joint venture all the way to mergers and acquisition (Noteboom, 1999, p. 1). This have include international coalition, strategic networks in addition to the more common “*strategic alliance*”. A nation’s successful industries are usually linked through vertical (buyer- supplier) which provides *cost reduction* and tap into technology (Porter, 1990, p. 305) or horizontal (common customers, technology, channels, better access to market information etc.) relationships which provide *strong market position* (Oster, 1999, p. 240).

Inter-organizational cooperation can potentially assist in reduction of transaction cost.

Alliances are agreements between different organizations, but they tend to be less formalized. They usually involve less investment (Weston & Weaver, 2001, p. 131). Various terms have been used to describe many different form of strategic alliance (Altug, 2016, p. 99). *Coalitions* between two or more firms, either formal or informal, who share compatible goals, acknowledge a level of mutual interdependence, and a reformed for strategic reasons (Stiles, 2001, p. 23, 24).

Joint ventures are separate business entities that are formed with other organizations that allow firms to share unique skills and spread risk among participating firms. Licensing is the granting of know-how and sometimes the physical equipment required to produce specified products is return for a royalty fee arrangement (Weston & Weaver, 2001, 2001, p. 128). Licensing can rapidly expand the market and achieve a high return on investment. Franchise agreements are contracts between the franchisor (parent) and the franchisee that grant the rights to use the parent’s name, reputations, and business model at specified location within a designated market area.

Merger and acquisition (M&A) are undertaken by companies to achieve certain strategic and financial objectives (Sudarsanam, 1995, p. xiii). *Cross-border acquisitions* that firm sees profitable opportunities in serving an overseas market with its own products or services. Firms acquire unique advantage; to exploit the company brands, reputation, design, production and management capabilities, and firms to access raw materials, technology, latest innovations and cheap-productive labor (Sudarsanam, 1995, p. xiii).

A *clusters* is a geographically proximate group of interconnected companies and in associated institutors in particular field, linked by commonalities and complementarities. Clusters also often involve a number of institution, governmental and otherwise, that provide specialized training, education, information, research, and technical support (such as universities, think tanks, vocational training providers), and standards - setting agencies. Government departments and regulatory agencies that significantly influence a cluster can be considered part of it (Porter, 2003, p. 254).

*Consortia* focus on generic precompetitive technology, neither type of arrangement, either alone or together (Procassani, 1995, p. 284). Alliance occur, such as technology, world markets and competition and implications for their purpose. It includes the role of scale, scope, experience and learning, information and communication technology, shortening life-cycles of products and pressure towards “*radical product differentiation*”. This leads to the conclusion that firms need to concentrate on core competencies, to outsource more activities and use outside partners as sources of complementary knowledge and competence. Alliances serve a variety of additional purposes: to spread fixed cost ( in production, distribution, R&D ), circumvent entry barriers, achieve speed of market entry, and learning about local business conditions, adapt products to markets, acquire sources of materials, components, labor, technology or learning, facilitate technology transfer, and they can shorten the time from product conception to commercialization, set market standards, provide stable, secure, long time supplier relations which a major source of competitive advantage (Blaine, 1994, p. 81,82), pre-empt or attack competition (Nooteboom, 1993, p. 43).

*Strategic alliances* are a dominant form of business organization and new forms of inter-firm cooperation. Strategic alliances are continuation of competition (Dieter & O’Connor, 1989, p. 25). Various form of inter-firm cooperation, contractual- collaborative arrangements usually result from growing cost and complexity of doing business in a global environment. Cost of developing new technologies and product, and the need to simultaneously enter the world’s major markets account for the popularity of new forms of arrangements (Blaine, 1994, p. 77). These arrangements offer the firms a number of additional strategic benefits as well. And strategic alliances involve production of knowledge or the sharing of activities, may include production of new products or process and involve activities (Shyam & Waverman, 1997, p. 128) that are dynamic in nature such as innovation or competition. Technologic cooperation or the integration of technology into the firm’s business operations is crucial to its successful management and hence it’s competitive advantage.

Taking into account all of these factors that provide to firm; competitiveness and cost reduction.

## **Conclusion**

Two of the critical determinants of competitiveness in an economy are “productivity improvements” and “technological innovations”.

The national economic system effectiveness, needs use of macroeconomic controls for achieving competitiveness. State interventions and regulates the national economic environment in which firms operate. The state is involved in micro and macroeconomic interventions to ensure this effectiveness. Since competition is no longer at national borders, government interventions are interventions that will ensure the competitiveness of national firms in the international

environment, especially in the high-tech marketplace. For this reason, the state reduces their costs by entering into cooperation with the firms and gives support to the firm as the biggest buyer (government procurement).

On the other hand, business strategy is being able to identify, attain and sustain competitive advantage (Oldman & Tomkins, 1999, p. xi). It is argued that superior value from the customer's perspective (sustainable competitive advantage) is achieved by focusing upon critical dimension of cost, technological capability, and procurement of raw materials. So firms focus on cost structure in a broad perspective rather than focusing on cost in narrow context. Michael E. Porter named this strategy as a value chain. From raw material intake to deliver of the product to the consumer. In the light of increasing intensity and velocity of competition, to meet the demands of this complex and dynamic environment, managers need new tools and perspective which to formulate and implement competitive strategies. Global competitiveness caused to collaboration of firms and act cost drivers (structural or executional). The creative destruction defined by Schumpeter means that the emergence of new products leads to a shortening of the existing product life cycles. For this reason global competitiveness has become more costly and has led companies to enter global collaborations. Failure to meet R & D costs due to product shortages leads to the main cause of cooperation. But this is not the only reason for cooperation.

While vertical cooperation provide to reduce the cost and horizontal cooperation provide monopoly power. And collaborations it is possible to reduce the R & D costs, entering new markets, exceeding entry barriers and using brand power, reputation, reducing distribution channel costs, entering new products, entering new technologies. Inter-organizational cooperation can potentially assist in reduction of transaction cost.

## References

- Altug, M.A. (2014). *Yalın Üretim Çevresinde Maliyet Yönetimi*, Türkmen Kitabevi, 2014.
- Altug, M.A. (2016). *Global Oyuncu Çokuluslu Şirketlerin (MSEs) Rekabet Stratejileri ve Maliyet Yönetimleri*, Türkmen Kitabevi, 2016.
- Blaine, J.M. (1994). *Co-operation in International Business*, Avebury, 1994.
- Blocher, E. J., Kung H. Chen., & Lin, T.W. (1999). *Cost Management: A Strategic Emphasis*, Irwin McGraw-Hill, 1999.
- Dieter, E. & O'Connor, D. (1989). *Technology and Global Competition. The challenge for newly Industrialising economies*, Paris, OECD, 1989.
- Eldenburg, L., G., Wolcott, S.K. (2005). *Cost Management - Measuring, Monitoring, and Motivating Performance*, Wiley, 2005.
- Ernst, D., & O'Connor, D. (1989). *Technology and Global Competition: The Challenge for Newly Industrializing Economies*. Paris: DECD Development Centre.
- Foley, P. D., Watts, D.H. & Wilson, B. (1993). *New Technologies, skills and shortages and training strategies-* in: *New Technologies and the firm- Innovation and competition*, Edited by Peter Swan, Routledge.
- Gehlhar, M.; Regmi, A.; Stefanou, S.E.; Zoumas, B. (2006). In: *Competitiveness in Agriculture and the Food Industry: US and EU Perspectives / Fanfani, R., Ball, E., Gutierrez, L., Ricci Maccarini, E., Bologna, Italy : Bononia University Press - p. 289 - 304.*
- IMD World Competitiveness Center, International Institute for Management Development (IMD), (Accessed: April 2, 2018). <https://www.imd.org/wcc/world-competitiveness-reflections/international-competitiveness/>
- Kay, J.(1995). *Why Firms Succeed*. Oxford: Oxford University Press.
- Neumann, M. (2001). *Competition Policy. History, Theory and Practice*. Edward Elgar, Cheltenham, UK.
- Metcalfe, J. S., & Boden, M. (1993). *Paradigms, strategies and the evolutionary basis of technological innovation*. In: Swann, P. (Ed.), *New Technologies and the Firm: Innovation and Competition*. Routledge, London, pp. 83–102



- Nooteboom, B. (1999). *Inter-firm Alliances, Analysis and Design*, London: Routledge.
- Oldman, A. & Tomkins, C. (1999). *Cost Management and Its Interplay with Business Strategy and Context*, Ashgate Publishing Limited.
- Oster, S.M. (1999). *Modern Competitive Analysis*, Third Edition, Oxford University Press.
- Porter, M. E. (1980). *Competitive Strategy: Techniques for Analyzing Industries and Competitors*. New York: Free Press, 1980. (Republished with a new introduction, 1998.)
- Porter, M.E. (1990). *The Competitive Advantage of Nations*, The Free Press, New York, U.S.A., 1990.
- Porter, M. E. (1996). What Is Strategy? *Harvard Business Review*, November-December.
- Porter, M. E. (1998). *The Competitive Advantage of Nations*, Macmillan Press LTD.
- Porter, M. E. (1998). *Competitive Strategy: Techniques for Analyzing Industries and Competitors*, 1st Free Press ed, New York: Free Press, 1998.
- Porter, M. E. (2003). Location, Clusters, and Company Strategy in: *SMEs in the Age of Globalization*, edited by David B. Audretsch, Edward Elgar Publishing Ltd.
- Procassani, A.A. (1995). *Competitors in Alliance- Industry Associations - Global Rivalries and Business-Government Relations*, Quorum Books
- Romano, F. (2006). *Clinton and Blair: The Political Economy of the Third Way*, New York: Routledge, 2006.
- Shank, J.K., & Govindarajan, V. (1993). *Strategic Cost Management- New Tool for Competitive Advantage*, The Free Press, New York, USA.
- Shenkar, O., Luo, Y., & Tailan, C. (2014). *International Business*, Rouledge, 2014
- Shyam, K., & Waverman, L. (1997). *Strategic Alliances- A threat to competition? – Competition Policy in the Global Economy*, edited by Leonard Waverman, William S. Comanor and Akira Goto, Routledge, 1997.
- Stiglitz, J.E. and Wallsten S.J. (2000). Public-Private technology Partnerships: Promises and Pitfalls, in Vaillancourt Rosenau, Pauline (ed.), *Public-Private Policy Partnerships*, Cambridge, MA, The MIT Press, pp. 38.
- Stiles, J. (2001). Partner selection: Motivation and objectives, In: M. H. Tayeb (Ed.), *International business partnership: Issues and concerns* (pp. 23-24). Strategic Emphasis. Mc Graw-Hill, Inc. USA.
- Sudarsanam P.S. (1995). *The Essence of Mergers and Acquisitions*, Prentice Hall, 1995 *Supply and Services*, Canada, Ottawa, 1991.
- Tayyeb, M. (2001). International Business Partnership, Palgrave “Technological competition”, in *New Technologies and the Firm: Innovation and*
- Tyson, L. D. (1988). *Competitiveness: An analysis of the problem and perspective on future policy*, Global Competitiveness, Martin K. Starr, ed., New York: W. W.. Norton & Company
- Weston, J. F. & Weaver, S.C. (2001). *Mergers and Acquisitions*, McGraw-Hill

## ***Part 9: Strategy & Global Trends***

# **Organizational Complexity and Uncertainty: A Conceptual Evaluation of Proactive Environmental Strategy on Organizational Competitiveness**

Taiwo T. Lasisi, Kayode K. Eluwole, and Ali Ozturen

Faculty of Tourism  
Eastern Mediterranean University, North Cyprus

## **Abstract**

This study develops a conceptual model that try to provide maximum organizational competitiveness in hotel sector of hospitality industry. Building on social systems theory and uncertainty reduction theory, the current study proposes that uncertainty and complexity are directly antecedents of organizational complexity and the relationship can be mediated by proactive environmental strategies and moderated by hotel affiliations. Considering the increasing competition in the industry, organizations are constantly seeking to maintain their competitive edge over their competition and the findings of this study offers a bright spot for building competitiveness through organizational readiness for uncertainties and complexities.

**Keywords:** organizational competitiveness, proactive environmental strategies, uncertainty, complexity, hotel industry

## **Introduction**

Industry and organizational competitiveness has been one of the most important research focuses not only in business and economic studies but also in tourism and hospitality. Porter(1990), a famous economist was the first to introduce the concept of national competitiveness and the concept has however in the past decade gained a lot of relevance among management scholars (Roy, 2011). Most researches carried out on industrial competitiveness has been connected to manufacturing industry and interrelated sectors, however in recent years, researches are being carried out to examine the competitiveness of service sector at international level focusing on tourist destinations and hotel industry (Andrades & Dimanche, 2017; Fraj, Matute, & Melero, 2015; Iraldo et al., 2017).

As tourism and hotel industry persistently thrive globally, the competition within the industry is also fiercer. The tourism and hospitality industry over a prolonged time has been operating in instability, complexity and uncertainty; the hotel industry also operating in consumer-led and interconnected environment is also exposed to dynamism and interferences. According to Joshi, Poudyal and Larson (2017); Maria, Madalina, Catalina and Diana(2008); Tsui, Yuen and Fung(2017) some of the most important factors influencing and affecting competitiveness in the tourism and hospitality industry some of which are learning organization, interaction abilities, and technology and information technology and human resources. Learning organization was defined by Bayraktaroglu and Kutanis (2003) as the process where hotel organizations utilize novel global strategies while Rodríguez-Díaz and Espino-Rodríguez (2006) defined interaction abilities as the grander aptitudes organizations possess to manage resources.

Hotels with affiliation based on Ingram and Baum's (1997) opinion are said to have more innovation and knowledge resources as well as better brand image and competitiveness. Consequently, affiliated hotels are better prone to utilizing knowledge for their organizational

innovations because learning will occur not only at the hotel but with other affiliated organizations (Fraj et al., 2015). Most literatures and researches evaluating the competitiveness in hotel industry often evaluate some of factors and they also fail to create a framework that captures the relationship or explain the mediating and moderating influences of these factors on hotel organizational competitiveness. Therefore this research is aimed at understanding the moderating influence of affiliation on the relationship between uncertainty, complexity and organizational competitiveness

## **Literature Review and Proposition Development**

### *Uncertainty and Organizational Competitiveness*

The industrial environment has increasingly become dynamic and turbulent following internalization and globalization; new technologies and customer needs/demands have also become unpredictable, denser and changing rapidly (Tan, Zhang, & Wang, 2015). An environment that is highly uncertain can be characterized by short product development cycles and services; also, social capital will be requisite in order to sustain the external relationships that exist between the environmental factors that influence the organizational performance and the management (Acquaah, 2007). Accumulation of social capital can give organizations access to external sources of information and knowledge; also help them in transferring and adjusting to commercialized systems (Shrivastava, Pazzaglia, Sonpar, & McNamara, 2016).

The last aforementioned authors also stated that this accumulation process is strongly linked with innovative ability of organizations which can help them benefit from market opportunities and consequently increase their competitiveness. With the uncertainty in environment and the internalization/globalization trends, tourism managers are forced to improve their innovation capability and intellectual capital (Liu, 2017) in order to meet their customers' changing demands; also maintain their ties with suppliers and their competitors which will give them the opportunity to observe and adapt quickly to the environmental changes that will enable them to modify their operations to suit the needs and uncertainty of the environment.

There are different responses of organizations to environmental uncertainties according to Miles and Snow typology (Miles, Snow, Meyer, & Coleman, 1978). If organizations respond as prospectors and become innovative as well as take risk for growth opportunities, this will lead to higher organizational competitiveness. Invariably, the disposition of organizations towards the daunting uncertainty within their environment will greatly influence their competitive capability in the industry. Thus, building on the above argue, we propose that:

- *Proposition 1:* Uncertainty exerts a positive influence on organizational competitiveness

### *Complexity and Organizational Competitiveness*

Complexity refers to the total elements that make up an organization or its environment as well as the connections between the said elements. According to McElroy(2003), the complexity differential explain the complexity of a system and its environment; and posit that if the elements that make up an organization and their interrelations are directly proportional to each other in that the higher the number of elements and their interrelations, the higher the degree of complexity of the organization.

However, contrasting complexity definitions, social systems theory theorizes that “the environment is an organization-relative situation” Luhmann (1995, p. 181) because the complexity of an environment is totally dependent on the observing organization. An organization with high complexity often perceives its environment less complex (McElroy, 2003), however if an organization observes its environment as complex, it’s because the complexity of such organization is low. According to social systems theory, this indicates that the complexity an organization ascribes to its environment depends on the level of the organization’s complexity (Schneider, Wickert, & Marti, 2017).

According to Schreyögg and Steinmann (1987), social systems theory usually select only their aspect of their environment relevant to their existence/survival and disregard those regarded to as irrelevant. The selection process of social systems theory creates a peculiar environment, focus on distinct tasks, thereby maintaining their operational efficiency and effectiveness (Baraldi & Corsi, 2017). Nevertheless, if the organization’s complexity however remains low with respect to environment, Duncan (1972) believes the organization jeopardizes its survival because of its lack of ability to grasp its environmental complexity. With regards to political, economic, physical and technological conditions, organizational environment is constantly changing (Child & Rodrigues, 2011) and this constantly challenges organizations to uncover new and novel elements that might be crucial to their survival and they must constantly alter their complexity for them to remain competitive and viable. Following the above argument, hypotheses 2(a) and 2(b) are developed as:

- *Proposition 2a:* Organizational internal environmental complexity exerts positive influence on the observing organization’s Organizational Competitiveness
- *Proposition 2b:* Industry environmental complexity also exerts positive influence on the observing organization’s Organizational Competitiveness.

#### *Proactive Environmental Strategies (PES)*

Building on Hart's (1995) ‘Natural-resource-based view of the firm’, Aragón-Correa and Sharma (2003) claimed that PES is a dynamic capability that enable organization to develop and adjust their strategies to the uncertain and dynamic environment. PES entails implementing innovative and novel environmental reforms dependent on detectible process such as reverse logistics, prevention technologies or eco-design which implies that organizations employing PES are committed to resolving its environmental hitches via the establishment of novel practices (Buyse & Verbeke, 2003; Christmann, 2000). It is also related to complementary capabilities (Fraj et al., 2015) such as continuous innovation, stakeholders' integration ability or generative learning. PES as affirmed by Hart (1995) offers organizations competitive advantage due to the fact that it allows them to deploy complex, rare and unique capabilities that are difficult to imitate.

PES as a dynamic capability enables organizations to ‘sense and shape’ the nature and existence of environmental opportunities and threats (that is) seizing opportunities and maintaining competitiveness by enhancing and reconfiguring organizational resources (Teece, 2007). Therefore, organizational excellence in coordinating and integrating core competencies offers sustainable advantages. Proactive organizations, according to Hanna, Rocky Newman and Johnson, (2000) are able to internally ‘sense and shape’ opportunities frequently through innovative processes to prevent environmental ineffectiveness in operational procedures.

Goll and Rasheed (2004) opined that in order for organizations to manage uncertainty, they must heighten their social legitimacy by participating in social responsibilities. Managers often adopt PES by developing environmental protection program when uncertainty is characterized by flexible environmental legislation issues (Majumdar & Marcus, 2001). Additionally, complexity and uncertainty in the hotel industry will encourage managers and decision makers to take greater risks (Li & Tang, 2010) because they perceive environmental responsible behaviors as a means of improving their organizations reputations (Koh, Qian, & Wang, 2014), gain environmental legitimacy (Lewis, Walls, & Dowell, 2014) and competitiveness (López-Gamero & Molina-Azorín, 2016). Therefore, the aforementioned reasoning lends basic foundation for the argument that PES has integral relationship with uncertainty, complexity and competitiveness within hospitality organization. Hence, hypothesis 3, 4 and 5 are developed as follows:

- *Proposition 3:* Uncertainty is positively related to Proactive Environmental Strategy
- *Proposition 4:* Complexity is positively related to Proactive Environmental Strategy
- *Proposition 5:* Proactive Environmental Strategy is positively related to competitiveness

#### *Mediating Role of Proactive Environmental Strategy*

As previously mention in the literature, organizations employing PES as a dynamic capability are able to sense and shape. Sensing help organizations to understand the uncertainty in its environment which will avail them the opportunity of continuous innovation (Fraj et al., 2015) while shaping encourages flexibility and adaptability to the uncertainty and dynamism in the environment; organizations are able to adapt their strategies to align with the changes which could be from task environment (competitors, regulators, suppliers, etc.) or from the general environment (political, economic, technological, etc.) (Duncan, 1972).

PES is dependent on managers' interpretation and discretion of environmental matters such as opportunities (Majumdar & Marcus, 2001) and complexity (Leonidou, Leonidou, Fotiadis, & Zeriti, 2013). Due to the fact that PES is non-imitable and non-replicable in that it requires both involvement, commitment and coordination of staff (Sharma & Vredenburg, 1998) and logical sequential process in reconfiguring resources (Fraj et al., 2015), this will aid hotel managers in having better understanding of the environmental complexity to be able to effectively and efficiently reconfigure resources for organizational competitiveness (Cheraghalizadeh & Tümer, 2017).

- *Proposition 6:* PES mediates the relationship between uncertainty and organizational competitiveness
- *Proposition 7:* PES mediates the relationship complexity and organizational competitiveness

#### *Affiliation as a Moderator*

According to Benito, Román and Guillén (2015), brand equity literature suggests that affiliation aids in offsetting competition and obtain competitiveness through customer loyalty. It also reduces the marketing action effects of competitors, improves profit margin in comparison to their competitors as well as effectiveness of marketing communication activity (Keller, 2002). In lieu of this, there is a difference in the competitiveness of affiliated and unaffiliated hotels (Blal

&Sturman, 2014; Zhang, Ye, & Law, 2011) as well as their motivations, initiatives and ability to respond or act (Smith, Menon, & Sivakumar, 2005; Wang, Chen, & Chen, 2012). Uncertainty Reduction Theory (URT) was created by Berger and Calabrese (1975) to explain the communication process that takes place when there is interaction between two strangers. They also claimed that when interaction proceeds, there is information flow and this reduces uncertainties (Lin, Kolobov, Kamar, Horvitz, & Redmond, 2015).

According to Kramer (1999) environmental uncertainty can be abridged through cognitive process while effective cognitive process will help in understanding the complexity of the organization and its element. However, cognitive development can be achieved by many factors such as affiliation (Gerson, Simpson, Paukner, Sommerville, & Decety, 2016). A research carried out by Ayuso (2006) shows that hotels having affiliations are better informed about important information about code of conducts and best environmental practices which is in congruence with research carried out by (Claver-Cortés, Molina-Azorí, Pereira-Moliner, & López-Gamero, 2007). During affiliation, opportunities are seized through new products/service, business model or technologies (Graci & Dodds, 2008) which was done by Fairmont Hotels by collaborating with WWF and US Environmental Protection Agency to create “Green Partnership” for a sustainable business model.

PES can be facilitated by organizational configurations of strategic affiliations for competency-oriented affiliations and environmental improvements that is characterized by explorative learning (Lin, 2012). As mentioned earlier, the perspective of dynamics capabilities to PES necessitates integrating the perspective of the divergent stakeholders (Aragón-Correa & Sharma, 2003; Sharma & Vredenburg, 1998). Furthermore, adoption of PES can result in organizations valuable competitive capabilities such as stakeholder integration and this can ultimately influence establishing affiliations to reduce uncertainty, better understand the complexity of the organization/industry, product and technology development (Fraj et al., 2015) for competitiveness. Therefore we posit that

*Proposition 8a: Affiliation fully moderates the mediation of PES in the relationship between uncertainty and organizational competitiveness.*

*Proposition 8b: Affiliation partially moderates the mediation of PES in the relationship between complexity and organizational competitiveness.*

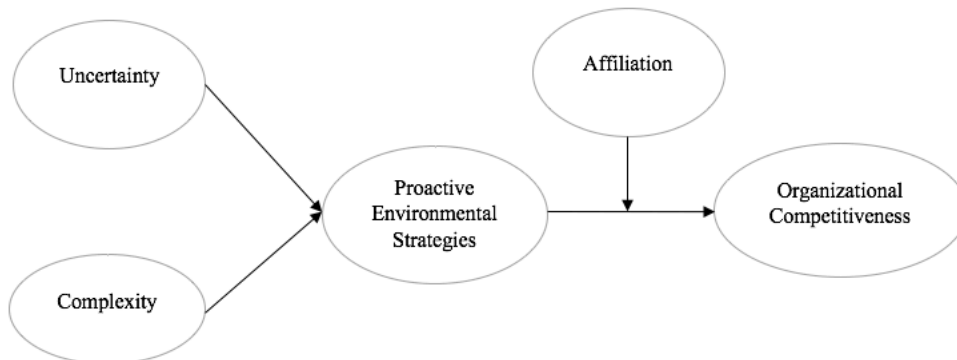

**Figure 1.** Conceptual model

Proactive environmental strategy in literature is often measured using a 16-items scale developed by (Gil, Jiménez, & Lorente, 2001; Sharma, 2009). The 16 items in the scale covers a divergent range of activities that exerts environmental influence on hospitality organizations. Some of such activities include organizational design, purchasing policy, environmental benchmarking, operations, customer involvement in environmental activities, implementation of environmental certification programs, environmental benchmarking, etc. This scale also indicates the depth of issues covered by the proactive environmental strategy construct.

Similarly, organizational competitiveness construct have been measured in recent literature using 5-item scale. Since competitiveness is often seen in the light of the competitions, the evaluation of organizational competitiveness requires managers to provide a candid assessment of their organization's competitive positioning with respect to their key competition as it touches gross profit, current profitability, achievement of corporate goals and long-term profitability outlook. Fraj et al.'s (2015) scale for measuring competitiveness stipulates the importance of requesting candid opinion of the managers since according to González-Benito and González-Benito (2005), managing executives have preference for providing subjective evaluation of their organization performance, the current study align with the previous studies to elucidate subjective opinions of hotel managers pertaining to their competitiveness.

Further, complexity construct considers the business environment in which business operates which may include the government and regulatory agencies. Mezner and Nigh's (1995) scale adequately address the concept and provides robust ground for determining organizational complexity. Also, uncertainty construct is robustly grounded in Hoque's (2004) scale. This scale provides specific focus on competitors, suppliers, customers; regulations, production and globalization roles in creating organizational uncertainty. Lastly, hotel's affiliation to chain, may alter their disposition towards uncertainty and complexity (Morgan, Kaleka & Katsikeas, 2004) such that collaboration with internal and external partners may influence the completion of market competition and invariably its impact on the business.

## **Discussion**

There is a positive relationship between uncertainty and competitiveness only if the organization respond to uncertainty as prospectors which is in congruence with findings from Köseoglu, Topaloglu, Parnell and Lester's (2013) research. Prospectors are highly innovative and proactive, ascribing much importance to flexibility. They also constantly observe their environment and carry out vast R & D activities (Allen & Helms, 2006; Tan, Fischer, Mitchell, & Phan, 2009) which increases their competitiveness. Organizational internal environmental complexity according to analysis of the data has a positive effect on the observing organization's Organizational Competitiveness because if an organization is able to grasp its own internal environment's complexity, its survival is protected and increases its competitiveness (Duncan, 1972). An organization that understands its internal environmental will better understand the external environment and consequently improves its competitiveness as well.

PES also fully mediated the relationship between uncertainty and competitiveness; and also the relationship between complexity was fully mediated by PES and this can be justified because when organizations perceives PES as a dynamic capability, they are able to use their cognitive



capabilities to sense their external and internal environment (Helfat & Peteraf, 2015) which helps them to understand allocation of resource to manage uncertainty and reduce complexity.

The result of the moderation analysis of the affiliation shows that affiliation fully moderates the mediation of PES in the relationship between uncertainty and organizational competitiveness because when the four and five star hotels are affiliated with other hotels or major stakeholders in the industry, the uncertainty will be reduced to the barest minimum (Bettencourt, 1997; Calveras & Orfila, 2014); affiliation however partially moderate the mediation of PES in the relationship between complexity and organizational competitiveness.

## Conclusion and Recommendations

The finding of this research shows that for four and five star hotels in Nigeria to improve in their competitiveness, they must take into cognizance the role of affiliation and PES in eliminating uncertainty and complexity of both the internal and external environment. This research is also applicable to other sectors within the tourism and hospitality industry as well as other industries.

The implication of this for managers is to firstly, adopt PES capabilities in their organizations to be able to sense and shape opportunities within the industry to reduce the uncertainty and complexity; secondly, this research will help managers understand the importance of affiliation in their competitiveness.

For future research, the role of knowledge sharing during affiliation and its impact of organizational competitiveness can be looked into. Also, leadership role can be examined in relation to using PES as a dynamic capability.

## References

- Acquaah, M. (2007). Managerial social capital, strategic orientation, and organizational performance in an emerging economy. *Strategic Management Journal*, 28(12), 1235–1255.
- Allen, R. S., & Helms, M. M. (2006). Linking strategic practices and organizational performance to Porter's generic strategies. *Business Process Management Journal*, 12(4), 433–454.
- Andrades, L., & Dimanche, F. (2017). Destination competitiveness and tourism development in Russia: Issues and challenges. *Tourism Management*, 62, 360–376.
- Aragón-Correa, J. A., & Sharma, S. (2003). A contingent resource-based view of proactive corporate environmental strategy. *Academy of Management Review*, 28(1), 71–88.
- Ayuso, S. (2006). Adoption of voluntary environmental tools for sustainable tourism: Analysing the experience of Spanish hotels. *Corporate Social Responsibility and Environmental Management*, 13(4), 207–220.
- Baraldi, C., & Corsi, G. (2017). *Niklas Luhmann: Education as a Social System*. Springer.
- Baron, R. M., & Kenny, D. A. (1986). The moderator--mediator variable distinction in social psychological research: Conceptual, strategic, and statistical considerations. *Journal of Personality and Social Psychology*, 51(6), 1173.
- Bayraktaroglu, S., & Kutanis, R. O. (2003). Transforming hotels into learning organisations: A new strategy for going global. *Tourism Management*, 24(2), 149–154.
- Benito, N. R., Román, N. V., & Guillén, M. J. Y. (2015). Measuring Store Brand Equity from the Formative Perspective: Differences between Heavy and Light Store Brand Buyers.
- Berger, C. R., & Calabrese, R. J. (1975). Some explorations in initial interaction and beyond: Toward a developmental theory of interpersonal communication. *Human Communication Research*, 1(2), 99–112.
- Bettencourt, L. A. (1997). Customer voluntary performance: Customers as partners in service delivery. *Journal of Retailing*, 73(3), 383–406.

- Blal, I., & Sturman, M. C. (2014). The differential effects of the quality and quantity of online reviews on hotel room sales. *Cornell Hospitality Quarterly*, 55(4), 365–375.
- Buysse, K., & Verbeke, A. (2003). Proactive environmental strategies: A stakeholder management perspective. *Strategic Management Journal*, 24(5), 453–470.
- Calveras, A., & Orfila, F. (2014). Intermediaries and quality uncertainty: Evidence from the hotel industry. *Tourism Economics*, 20(4), 727–756.
- Cheraghalizadeh, R., & Tümer, M. (2017). The effect of applied resources on competitive advantage in hotels: Mediation and moderation analysis. *Journal of Hospitality and Tourism Management*, 31, 265–272.
- Child, J., & Rodrigues, S. (2011). Social identity and organizational learning. *Handbook of Organizational Learning and Knowledge Management*, 2, 305–329.
- Christmann, P. (2000). Effects of “best practices” of environmental management on cost advantage: The role of complementary assets. *Academy of Management Journal*, 43(4), 663–680.
- Claver-Cortés, E., Molina-Azorí, J. F., Pereira-Moliner, J., & López-Gamero, M. D. (2007). Environmental strategies and their impact on hotel performance. *Journal of Sustainable Tourism*, 15(6), 663–679.
- Duncan, R. B. (1972). Characteristics of organizational environments and perceived environmental uncertainty. *Administrative Science Quarterly*, 313–327.
- Fornell, C., & Larcker, D. F. (1981). Evaluating structural equation models with unobservable variables and measurement error. *Journal of Marketing Research*, 39–50.
- Fraj, E., Matute, J., & Melero, I. (2015). Environmental strategies and organizational competitiveness in the hotel industry: The role of learning and innovation as determinants of environmental success. *Tourism Management*, 46, 30–42.
- Gerson, S., Simpson, E. A., Paukner, A., Sommerville, I. J., & Decety, J. (2016). Drivers of social cognitive development in human and non-human primate infants. *Social Cognition: Development Across the Life Span*, 98.
- Gil, M. J. A., Jiménez, J. B., & Lorente, J. J. C. (2001). An analysis of environmental management, organizational context and performance of Spanish hotels. *Omega*, 29(6), 457–471.
- Goll, I., & Rasheed, A. A. (2004). The moderating effect of environmental munificence and dynamism on the relationship between discretionary social responsibility and firm performance. *Journal of Business Ethics*, 49(1), 41–54.
- González-Benito, J., & González-Benito, Ó. (2005). Environmental proactivity and business performance: an empirical analysis. *Omega*, 33(1), 1–15.
- Graci, S., & Dodds, R. (2008). Why go green? The business case for environmental commitment in the Canadian hotel industry. *Anatolia*, 19(2), 251–270.
- Hanna, M. D., Rocky Newman, W., & Johnson, P. (2000). Linking operational and environmental improvement through employee involvement. *International Journal of Operations & Production Management*, 20(2), 148–165.
- Hart, S. L. (1995). A natural-resource-based view of the firm. *Academy of Management Review*, 20(4), 986–1014.
- Helfat, C. E., & Peteraf, M. A. (2015). Managerial cognitive capabilities and the microfoundations of dynamic capabilities. *Strategic Management Journal*, 36(6), 831–850.
- Hoque, Z. (2004). A contingency model of the association between strategy, environmental uncertainty and performance measurement: impact on organizational performance. *International Business Review*, 13(4), 485–502.
- Iacobucci, D., Saldanha, N., & Deng, X. (2007). A meditation on mediation: Evidence that structural equations models perform better than regressions. *Journal of Consumer Psychology*, 17(2), 139–153.
- Ingram, P., & Baum, J. A. C. (1997). Chain affiliation and the failure of Manhattan hotels, 1898-1980. *Administrative Science Quarterly*, 68–102.
- Iraldo, F., Iraldo, F., Testa, F., Testa, F., Lanzini, P., Lanzini, P., ... Battaglia, M. (2017). Greening competitiveness for hotels and restaurants. *Journal of Small Business and Enterprise Development*.
- Joshi, O., Poudyal, N. C., & Larson, L. R. (2017). The influence of sociopolitical, natural, and cultural factors on international tourism growth: a cross-country panel analysis. *Environment, Development and Sustainability*, 19(3), 825–838.
- Keller, K. L. (2002). Branding and brand equity. *Handbook of Marketing*, 151.
- Koh, P.-S., Qian, C., & Wang, H. (2014). Firm litigation risk and the insurance value of corporate social performance. *Strategic Management Journal*, 35(10), 1464–1482.

- Köseoglu, M. A., Topaloglu, C., Parnell, J. A., & Lester, D. L. (2013). Linkages among business strategy, uncertainty and performance in the hospitality industry: Evidence from an emerging economy. *International Journal of Hospitality Management*, 34, 81–91.
- Kramer, M. W. (1999). Motivation to reduce uncertainty: A reconceptualization of uncertainty reduction theory. *Management Communication Quarterly*, 13(2), 305–316.
- Leonidou, L. C., Leonidou, C. N., Fotiadis, T. A., & Zeriti, A. (2013). Resources and capabilities as drivers of hotel environmental marketing strategy: Implications for competitive advantage and performance. *Tourism Management*, 35, 94–110.
- Lewis, B. W., Walls, J. L., & Dowell, G. W. S. (2014). Difference in degrees: CEO characteristics and firm environmental disclosure. *Strategic Management Journal*, 35(5), 712–722.
- Li, J., & Tang, Y. I. (2010). CEO hubris and firm risk taking in China: The moderating role of managerial discretion. *Academy of Management Journal*, 53(1), 45–68.
- Lin, C. H., Kolobov, A., Kamar, E., Horvitz, E., & Redmond, W. A. (2015). Metareasoning for Planning Under Uncertainty. In *IJCAI* (pp. 1601–1609).
- Lin, H. (2012). Strategic alliances for environmental improvements. *Business & Society*, 51(2), 335–348.
- Liu, C.-H. (2017). The relationships among intellectual capital, social capital, and performance-The moderating role of business ties and environmental uncertainty. *Tourism Management*, 61, 553–561.
- López-Gamero, M. D., & Molina-Azorín, J. F. (2016). Environmental management and firm competitiveness: the joint analysis of external and internal elements. *Long Range Planning*, 49(6), 746–763.
- Luhmann, N. (1995). *Social systems*. Stanford University Press.
- Majumdar, S. K., & Marcus, A. A. (2001). Rules versus discretion: The productivity consequences of flexible regulation. *Academy of Management Journal*, 44(1), 170–179.
- Maria, I., Madalina, T., Catalina, B., & Diana, I. (2008). The factors of competitiveness in the hospitality industry and the competitive strategy of firms. *Annals of the University of Oradea, Economic Science Series*, 17(2), 213–218.
- McElroy, M. W. (2003). *The new knowledge management: Complexity, learning, and sustainable innovation*. Routledge.
- Meznar, M. B., & Nigh, D. (1995). Buffer or bridge? Environmental and organizational determinants of public affairs activities in American firms. *Academy of Management Journal*, 38(4), 975–996.
- Miles, R. E., Snow, C. C., Meyer, A. D., & Coleman, H. J. (1978). Organizational strategy, structure, and process. *Academy of Management Review*, 3(3), 546–562.
- Morgan, N. A., Kaleka, A., & Katsikeas, C. S. (2004). Antecedents of export venture performance: A theoretical model and empirical assessment. *Journal of Marketing*, 68(1), 90–108.
- Porter, M. E. (1990). The competitive advantage of nations. *Harvard Business Review*, 68(2), 73–93.
- Rodríguez-Díaz, M., & Espino-Rodríguez, T. F. (2006). Developing relational capabilities in hotels. *International Journal of Contemporary Hospitality Management*, 18(1), 25–40.
- Roy, S. (2011). Competitiveness in service sector: a case of hotel industry in India. *Global Business Review*, 12(1), 51–69.
- Schneider, A., Wickert, C., & Marti, E. (2017). Reducing complexity by creating complexity: a systems theory perspective on how organizations respond to their environments. *Journal of Management Studies*, 54(2), 182–208.
- Schreyögg, G., & Steinmann, H. (1987). Strategic control: A new perspective. *Academy of Management Review*, 12(1), 91–103.
- Sharma, S. (2009). The mediating effect of information availability between organization design variables and environmental practices in the Canadian hotel industry. *Business Strategy and the Environment*, 18(4), 266–276.
- Sharma, S., & Vredenburg, H. (1998). Proactive corporate environmental strategy and the development of competitively valuable organizational capabilities. *Strategic Management Journal*, 729–753.
- Shrivastava, S., Pazzaglia, F., Sonpar, K., & McNamara, P. (2016). Unpacking the effect of exploration during environmental uncertainty: Evidence from the information technology sector. *Canadian Journal of Administrative Sciences/Revue Canadienne Des Sciences de l'Administration*, 33(1), 36–49.
- Smith, D., Menon, S., & Sivakumar, K. (2005). Online peer and editorial recommendations, trust, and choice in virtual markets. *Journal of Interactive Marketing*, 19(3), 15–37.
- Tan, J., Fischer, E., Mitchell, R., & Phan, P. (2009). At the center of the action: Innovation and technology strategy research in the small business setting. *Journal of Small Business Management*, 47(3), 233–262.

- Tan, J., Zhang, H., & Wang, L. (2015). Network Closure or Structural Hole? The Conditioning Effects of Network-Level Social Capital on Innovation Performance. *Entrepreneurship Theory and Practice*, 39(5), 1189–1212.
- Teece, D. J. (2007). Explicating dynamic capabilities: the nature and microfoundations of (sustainable) enterprise performance. *Strategic Management Journal*, 28(13), 1319–1350.
- Tsui, K. W. H., Yuen, A. C.-L., & Fung, M. K. Y. (2017). Maintaining competitiveness of aviation hub: Empirical evidence of visitors to China via Hong Kong by air transport. *Current Issues in Tourism*, 1–25.
- Wang, C.-H., Chen, K.-Y., & Chen, S.-C. (2012). Total quality management, market orientation and hotel performance: The moderating effects of external environmental factors. *International Journal of Hospitality Management*, 31(1), 119–129.
- Zhang, Z., Ye, Q., & Law, R. (2011). Determinants of hotel room price: An exploration of travelers' hierarchy of accommodation needs. *International Journal of Contemporary Hospitality Management*, 23(7), 972–981.

***Part 10: Technology, E-Business & Social  
Media***

# Customer Engagement With Social Commerce: A Motivation Analysis

Tingting Zhang and Po-Ju Chen

Rosen College of Hospitality Management  
University of Central Florida, USA

## Abstract

The current study adopted motivation analysis approach to investigate the factors that drive customers to engage with social commerce. Guided by motivation theory, intrinsic and extrinsic motivation factors were identified and examined through a self-administered online survey. Results indicated that three types of intrinsic motivation including knowledge, accomplishment, and stimulation as well as two types of extrinsic motivation such as external regulation and introjected regulation had positive effects on customer engagement with social commerce. However, one type of extrinsic motivation, identified regulation was found no statistically significantly related with customer engagement behavior with social commerce. The increasing trend of social media provides an opportunity for businesses to expand their activities and enjoy the presence of thousands of potential customers in one place. By focusing on the new understudied phenomenon of social commerce, this study makes great contribution to the body of knowledge and provides valuable implications to both practitioners and policy makers.

**Keywords:** social commerce, customer engagement, intrinsic motivation, extrinsic motivation, motivation analysis

## Introduction

Social commerce has been labeled by Google as a growing trend in the market (Kim, 2013). Various firms have proactively practiced social commerce in their strategic approaches. For example, Macy's offers product order functions on Pinterest to enable direct orders of Macy's products while people browse product pictures on Pinterest. Many other traditional retailers are also actively leveraging social media for commerce, such as Nordstrom's, Bloomingdale's, and Wayfair. On the other hand, some social networking sites also seize the opportunity and add commercial features to their websites. Facebook has further facilitated social commerce by enabling companies to create "Shop Now" virtual stores and use Facebook Messenger for pre-/post-sale customer communication and interaction. The commercial impact of social commerce is quite clear when evaluating market performance over the last few years. One study that examined Australian markets found that the total sales social commerce generated in 2010-2011 reached about 189 billion dollars (Lazar, 2015). The revenue generated by social commerce has been continuously increased in the last few years (Kholod, 2017). Therefore, practitioners and academia should study how to leverage the engine of social commerce for sustainable competitiveness and market share.

Undoubtedly, the success of social commerce mostly depends on customer participation and engagement. Understanding why and how customers engage in social commerce is the key to businesses being able to unleash the potential value of social commerce. Since social commerce has been in its fledging stage, sparse research has focused on this topic. The current study pioneers and contributes to the body of knowledge by adopting a motivation analysis of customer engagement with social commerce. Customer engagement is a broad term, and there is a lot of

discussion about its conceptualization and scope (social, emotional, behavioral, etc.). For the current research, customer engagement behavior has been defined as the concept metric. Customer engagement behavior in social commerce includes both direct and indirect commercial transactions. Direct transaction refers to the purchase behavior while indirect transactions may include referral and e-WOM behaviors. Referrals and e-WOM behaviors regarding brands and products on social media have been the subject of many diverse studies (Chu & Kim, 2011; De Vries, L., Gensler, & LeeFlang, 2012; Goh, Heng, & Lin, 2013; Hollebeek, Glynn, & Brodie, 2014). Given that the essence of social commerce is to increase sales for companies (Kim, 2013), this study focuses on consumer purchase behavior via social media and ultimately suggests the underlying strategic paradigm that optimizes customer engagement with social commerce to drive customer purchases.

## **Literature Review**

Social commerce is a new trend in social media that refers to commercial activities in online communities (Hajli, Shanmugam, Powell, & Love, 2015). This new phenomenon is composed of four major interrelated components: customers, business, information and technology (Zhou, Zhang, & Zimmermann, 2013). The role of customers is particularly significant in social commerce since customer behavior is greatly influenced by other components. Also, since social commerce turns passive customers into active participants who can engage with value co-creation, the level of customer participation in social commerce is greater than participation in any other traditional or online transaction (Pongsakornrungrasit & Schroeder, 2011). Thus, a new line of research that examines the factors affecting customer engagement with social commerce has emerged in academia. The studies conducted in this area mostly focus on technological and social factors that support customer activities in the domain of social commerce (Hajli, 2015; (Yadav, de Valck, Hennig-Thurau, Hoffman, & Spann, 2013).

Deci and Ryan (1985) developed Motivation Theory which focuses on the motivation behind individual behaviors and choices. This theory classifies motivation systems underlying individual behavior into intrinsic and extrinsic motivation. When an individual is motivated intrinsically, that person performs a task because of an interest in the task itself; however, when someone is motivated extrinsically, the person performs the task to achieve a specific external value or reward (Davis, Bagozzi, & Warshaw, 1992). Previous studies have examined various dimensions of intrinsic and extrinsic motivation in different contexts from education to sports, which will be reviewed in following sections.

Intrinsic motivation refers to engaging in an activity because of an individuals' internal psychological needs of self-determination and competence (Deci, 1975). Intrinsic motivation can be classified into three types: intrinsic motivation to know (Knowledge), to accomplish tasks (Accomplishment), and to experience stimulation (Stimulation) (Deci & Ryan, 1985).

Intrinsic motivation to know (Knowledge) refers to engaging in an activity for the enjoyment that an individual experiences during exploring or learning something. Prior literature of online social communities has indicated the positive effect of factors such as curiosity and learning goals on online behaviors. For example, Koo and Ju (2010) stated that curiosity motivates online shoppers to seek information about a product or service and removes their uncertainty about online purchases. In addition, other studies explored the concept of flow in online behaviors and identified

that “joy of discovery and learning” is a motivator of online behaviors (Hoffman & Novak, 2009; Pace, 2004).

Thus, the current study hypothesizes:

H1a: Knowledge has a positive effect on customer engagement with social commerce.

Intrinsic motivation to accomplish (accomplishment) refers to engaging in an activity to gain unique achievements and competency (Deci & Ryan, 1985). O’Brien and Toms (2008) conducted a study on online games and showed that players’ tendency to accomplish certain levels of an online game motivate them to engage with this online activity. Rienties, Tempelaar, Van den Bossche, Gijssels, and Segers (2009) also found that the intrinsic motivation to accomplish tasks draws academic users to engage in computer-supported collaborative learning.

Thus, the current study hypothesizes:

H1b: Accomplishment has a positive effect on customer engagement with social commerce.

Finally, intrinsic motivation to experience stimulation (stimulation) refers to engaging in an activity to experience pleasure, fun and excitement which are stimulating sensations. Lowry, Gaskin, Twyman, Hammer, and Roberts (2013) conducted a study on online games and showed that players’ motivation to experience joy and excitement drives them to play online games. In terms of online shopping, Perea y Monsués, Dellaert, and De Ruyter (2004) showed the positive effect of enjoyment on customer online shopping behavior.

Thus, the current study hypothesizes:

H1c: Stimulation has a positive effect on customers’ engagement with social commerce.

Extrinsic motivation refers to engaging in an activity caused by factors outside an individual’s internal feelings and stimuli (Ryan & Deci, 2000). For example, the possibility of saving time through online shopping is an external factor that motivates individuals to engage with online stores. In order to consider extrinsic motivation holistically, it is critical to focus on its three major types that are assessed along a self-determination continuum: external regulation, introjected regulation and identified regulation (Deci & Ryan, 1985).

External regulation refers to the regulation of behavior through external factors such as rewards or punishments (Deci & Ryan, 1985). In this case, an individual’s self-determination is at its lowest level and his or her behavior is fully determined by rewards and punishments. A significant body of literature investigated the influence of self-regulation on online learning (Chen & Jang, 2010; Roca & Gagné, 2008). As mentioned earlier, these studies mainly focused on perceived usefulness and perceived ease of use as two major external factors driving user behavior (Childers et al., 2001; Gefen et al., 2003).

Thus, this study hypothesizes:

H2a: External regulation has a positive effect on customer engagement with social commerce.



Introjected regulation, the second type of extrinsic motivation, refers to an individual's behavior that is internalized by understanding the reasons behind his or her behavior (Deci & Ryan, 1985). Social presence is the extent to which users psychologically experience others' presence (Fulk, Steinfield, Schmitz, & Power, 1987), which is critical to commercial activities. Previous studies showed that a high level of social presence and social influence on online platforms is the major motivator of online activities such as online purchasing (Gatautis & Medziausiene, 2014; Hajli et al., 2015).

Thus, this study hypothesizes:

H2b: Introjected regulation has a positive effect on customer engagement with social commerce.

Identified regulation, the third type of extrinsic motivation, refers to a behavior that is highly valued by an individual because it is selected by that person based on the reasons that are important to him or her (Deci & Ryan, 1985). Here, the customer is driven to do a specific task by his own will. There are a lot of studies which highlight the importance of customers' prior experience and brand loyalty in online platforms. For example, Ling, Chai, and Piew (2010) showed that prior online purchase experience and brand orientation have positive effect on customers' online purchase intentions. Naseri and Elliott (2011) also showed the positive influence of prior experience on customers' online shopping. Park and Kim (2003) indicated the positive relationship between brand commitment and online purchase behavior.

Thus, this study hypothesizes:

H2c: Identified regulation has a positive effect on customer engagement with social commerce.

## **Methods**

### *Measures and Scale Development*

The scales for measuring intrinsic and extrinsic motivation and customer engagement were mainly developed based on previous literature. Given the nascent nature of social commerce, to assist in developing the questionnaire instrument, focus group interviews were conducted with participants who had experience with social commerce in the prior six months. The final scale for measuring the constructs in the proposed model was developed based on the relevant literature and the results of the focus group interviews.

### *Data Collection*

Data collection was undertaken in September 2017 and lasted for two weeks to complete the process. Consumers who made purchases of services or products through social media in the last six months were invited to participate in the study. A structured questionnaire was employed to collect responses from the participants and a panel of experts were invited to assess the word appropriateness of the questions. Amazon Mechanical Turk—an online marketing agency—distributed the survey within its system to the sample. Participants who answered the questionnaires received \$1 for compensation. At the beginning of the questionnaire, the definition of social commerce was explained with examples of related business practices and participants were asked to bear their most recent social commerce experience in mind while answering the

questions. In the final section of the questionnaire, demographic information about the respondents was collected. Qualtrics served as the platform for designing the online questionnaire. A pilot test was conducted to ensure the reliability and validity of the instrument. After data screening, 298 valid responses were collected.

## **Findings**

### *Evaluating the Measurement Model*

The model constructs were assessed by Confirmatory Factor Analysis (CFA) to ensure the reliability as well as the convergent and discriminant validity using SPSS Amos 22 version. Cronbach's Alpha was adopted to assess the reliability of the constructs and all the scores were above 0.80, which is higher than the 0.7 threshold indicating the reliable constructs (Chen and Hitt, 2002). As Table 2 shows, the average variance extracted (AVE) values ranged from 0.65 to 0.80, which indicate the convergent validity of the constructs. Discriminant validity was assessed by comparing the AVE scores with the squared correlation between pairs of constructs. The squared correlations were less than the AVE scores, indicating discriminant validity in the current data. In addition, Statistical package SPSS was used to test multicollinearity issues and all the variable inflation factors were less than 3, suggesting no multicollinearity issues in the dataset. The goodness-of-fit measures were used to assess the overall model fit. Based on the model fit indices, the proposed measurement model demonstrated an appropriate fit:  $\chi^2$ -to-df index = 1.50, CFI = 0.97, GFI = 0.97, AGFI = 0.92, RMSEA = 0.04, and PCLOSE = 0.77. All of the fit indices for the measurement model indicated an acceptable fit.

### *Testing the Structural Model*

Structural equation modeling (SEM) was used to test the hypothesized model with the entire sample of 298 participants. The overall fit indices for the proposed model were acceptable, with a  $\chi^2$ -to-df = 2.12, CFI = 0.98, GFI = 0.94, AGFI = 0.91, RMSEA = 0.04, and PCLOSE = 1.00. As Figure 1 shows, the results indicated that the direct relationship between Knowledge and Engagement with social commerce ( $\beta = 0.36$ ) was positive at  $p < 0.01$ , thus supporting H1a. Accomplishment and Stimulation were also found to have statistically significant relationships with Engagement with social commerce ( $\beta = 0.56, p < 0.001$ ;  $\beta = 0.32, p < 0.01$ ), supporting H1b and H1c. As for extrinsic motivation factors, the path coefficient indicated a significant relationship between External regulation and Engagement with social commerce ( $\beta = 0.45, p < 0.01$ ), which supported H2a. The study also found significant relationships between Introjected regulation and Engagement with social commerce ( $\beta = 0.34, p < 0.05$ ), which therefore supported H2b. The other external motivation factor, Identified regulation, had no statistically significant relation with Engagement with social commerce ( $\beta = 0.10, p > 0.05$ ), thus failing to support H2c.

## **Conclusions**

As social networking and electronic commerce permeate the marketplace, social commerce is believed to be instrumental in helping people engage in online social commercial activities by sharing their knowledge and experiences of products or services (Liang et al., 2011). Given that users' shared experiences, recommendations, and information typically serve as the basis for social commerce, their engagement is critical for social commerce success (Liang et al., 2011).

Consequently, it has become increasingly important to attain a better understanding of user engagement in social commerce.

### *Implications*

Based on the Motivation Theory (Deci & Ryan, 1985), this study devised an overarching theoretical framework that comprehensively addresses the unique role of intrinsic and extrinsic motivation, including external regulation, introjected regulation, identified regulation, knowledge, accomplishment, and stimulation, in determining social commerce engagement, thus adding to the literature on social commerce. In general, results show that both intrinsic and extrinsic motivation positively and significantly impact customer engagement with social commerce, offering strong empirical evidence in support of the motivation theoretical framework's explanatory power of customer engagement with social commerce. This study has presented an initial attempt to explore the determinants of user engagement with social commerce—the constructed model exhibited high model fits (CFI = 0.98, GFI = 0.94, AGFI = 0.91)—leading to opportunities for better understanding of the underlying mechanisms of the emerging social phenomenon of customer engagement with social commerce.

### *Future Research*

In addition, this study highlights the role of motivation in enhancing customer engagement. Several interesting points emerged from findings of empirical examinations. First, this study demonstrates that knowledge, accomplishment, and stimulation exert positive and significant impact on customer engagement with social commerce. In particular, accomplishment appeared to have the strongest impact on engagement with social commerce. This finding is enlightening in that customers may engage more in social commerce when they face reasonably more challenges to making a final decision, as their sense of achievement would increase. Overall, these findings strongly support the idea that intrinsic motivation is important in improving customer engagement with social commerce.

### **References**

- Bai, Y., Yao, Z., & Dou, Y. F. (2015). Effect of social commerce factors on user purchase behavior: An empirical investigation from renren.com. *International Journal of Information Management*, 35(5), 538–550. <https://doi.org/10.1016/j.ijinfomgt.2015.04.011>
- Childers, T. L., Carr, C. L., Peck, J., & Carson, S. (2001). Hedonic and utilitarian motivations for online retail shopping behavior. *Journal of Retailing*, 77(4), 511–535.
- Chu, S. C., & Kim, Y. (2011). Determinants of consumer engagement in electronic word-of-mouth (eWOM) in social networking sites. *International Journal of Advertising*, 30(1), 47–75.
- De Vries, L., Gensler, S., & LeeFlang, P. S. (2012). Popularity of brand posts on brand fan pages: An investigation of the effects of social media marketing. *Journal of Interactive Marketing*, 26(2), 83–91.
- Deci, E. L. (1975). Conceptualizations of Intrinsic Motivation. In *Intrinsic motivation* (pp. 23–63). US: Springer.
- Fulk, J., Steinfield, C. W., Schmitz, J., & Power, J. G. (1987). (A social information processing model of media use in organizations. *Communication Research*, 14(5), 529–552.
- Gabriela, L. P. A., Hor-meyll, L. F., & de Paula Pessôa, L. A. G. (2014). Influence of virtual communities in purchasing decisions: The participants' perspective. *Journal of Business Research*, 882–890(67), 882–890.
- Gatautis, R., & Medziausiene, A. (2014). Factors Affecting Social Commerce Acceptance in Lithuania. *Procedia - Social and Behavioral Sciences*, 110(2013), 1235–1242. <https://doi.org/10.1016/j.sbspro.2013.12.970>
- Gefen, D., Karahanna, E., & Straub, D. W. (2003). Trust and TAM in Online Shopping: An Integrated Mode. *MIS Quarterly*, 27(1), 51–90. <https://doi.org/10.1017/CBO9781107415324.004>

- Goh, K. Y., Heng, C. S., & Lin, Z. (2013). Social media brand community and consumer behavior: Quantifying the relative impact of user-and marketer-generated content. *Information Systems Research*, 24(1), 88–107.
- Harris, L. C., & Reynolds, K. L. (2003). The consequences of dysfunctional customer behavior. *Journal of Service Research*, 6(2), 144–161.
- Harris, L. C., & Reynolds, K. L. (2004). Jaycustomer behavior: an exploration of types and motives in the hospitality industry. *Journal of Services Marketing*, 18(5), 339–357.
- Ho-Dac, N. N., Carson, S. J., & Moore, W. L. (2013). The effects of positive and negative online customer reviews: do brand strength and category maturity matter? *Journal of Marketing*, 77(6), 37–53.
- Hoffman, D. L., & Novak, T. P. (2009). Flow Online: Lessons Learned and Future Prospects. *Journal of Interactive Marketing*, 23(1), 23–34. <https://doi.org/10.1016/j.intmar.2008.10.003>
- Hollebeek, L. D. (2011). Demystifying customer brand engagement: Exploring the loyalty nexus. *Journal of Marketing Management*, 27(7–8), 785–807.
- Hollebeek, L. D., Glynn, M. S., & Brodie, R. J. (2014). Consumer brand engagement in social media: Conceptualization, scale development and validation. *Journal of Interactive Marketing*, 28(2), 149–165.
- Huang, Z., & Benyoucef, M. (2013). From e-commerce to social commerce: A close look at design features. *Electronic Commerce Research and Applications*, 12(4), 246–259. <https://doi.org/10.1016/j.elerap.2012.12.003>
- Kelley, S. W., Donnelly Jr, J. H., & Skinner, S. J. (1990). Customer participation in service production and delivery. *Journal of Retailing*, 66(3), 315–335.
- Koo, D. M., & Ju, S. H. (2010). The interactional effects of atmospherics and perceptual curiosity on emotions and online shopping intention. *Computers in Human Behavior*, 26(3), 377–388. <https://doi.org/10.1016/j.chb.2009.11.009>
- Laroche, M., Habibi, M. R., Richard, M. O., & Sankaranarayanan, R. (2012). The effects of social media based brand communities on brand community markers, value creation practices, brand trust and brand loyalty. *Computers in Human Behavior*, 28(5), 1755–1767.
- Lazar, M.-J. (2015). Epic Social Commerce Facts. Retrieved May 10, 2017, from <https://www.readycloud.com/info/tweetthis-unbelievable-social-commerce-facts-for-2015>
- Liang, T.-P., Ho, Y.-T., Li, Y.-W., & Turban, E. (2011). What Drives Social Commerce: The Role of Social Support and Relationship Quality. *International Journal of Electronic Commerce*, 16(2), 69–90. <https://doi.org/10.2753/JEC1086-4415160204>
- O'Brien, H. L., & Toms, E. G. (2008). What is user engagement? A Conceptual Framework for defining user engagement with technology. *Journal of the American Society for Information Science and Technology*, 59(6), 938–955. <https://doi.org/10.1002/asi.20801.1>
- Park, C., & Kim, Y. (2003). Identifying key factors affecting consumer purchase behavior in an online shopping context. *International Journal of Retail & Distribution Management*, 31(1), 16–29. <https://doi.org/10.1108/09590550310457818>
- Ramayah, T., & Ignatius, J. (2005). Impact of perceived usefulness, perceived ease of use and perceived enjoyment on intention to shop online. *ICFAI Journal of Systems Management*, 3(3), 36–51.
- Roca, J. C., & Gagné, M. (2008). Understanding e-learning continuance intention in the workplace: A self-determination theory perspective. *Computers in Human Behavior*, 24(4), 1585–1604.
- Rohm, A. J., & Swaminathan, V. (2004). A typology of online shoppers based on shopping motivations. *Journal of Business Research*, 57(7), 748–757. [https://doi.org/10.1016/S0148-2963\(02\)00351-X](https://doi.org/10.1016/S0148-2963(02)00351-X)
- Yadav, M. S., de Valck, K., Hennig-Thurau, T., Hoffman, D. L., & Spann, M. (2013). Social commerce: A contingency framework for assessing marketing potential. *Journal of Interactive Marketing*, 27(4), 311–323. <https://doi.org/10.1016/j.intmar.2013.09.001>
- Zhang, H., Lu, Y., Gupta, S., & Zhao, L. (2014). What motivates customers to participate in social commerce? the impact of technological environments and virtual customer experiences. *Information and Management*, 51(8), 1017–1030. <https://doi.org/10.1016/j.im.2014.07.005>

## *Part 11: Chapter of Abstracts*

# **Accounting**

# Necessary and Sufficient Conditions for Liquidity Management

José Antonio de França<sup>1</sup> and Wilfredo Sosa Sandoval<sup>2</sup>

<sup>1</sup>University of Brasilia

<sup>2</sup>Catholic University of Brasilia, Brazil

## Abstract

Traditionally, liquidity is measured by financial indicators, centered in the current ratio (CR) as an indicator of nominal payment capacity. However, this indicator generates a gap in the liquidity assessment because it does not measure financial efficiency nor liquidity sustainability. This research paper proposes an indicator that combines nominal capacity with effective payment capacity that indicates the liquidity sustainability and financial efficient status, addressing a gap in the literature concerning liquidity management. In order to test this proposition, this study used data from financial statements of 37 manufacturing firms from 2000 to 2015, via parametric and nonparametric methods. In the analysis showed here, financial efficiency ratio (FER) and the liquidity sustainability ratio (LSR) were used to assess financial efficiency and sustainable liquidity. Robust empirical evidences were found showing that the main status of the firms' liquidity is weakly sustainable. The results suggest that the combination of financial efficiency and nominal liquidity is a robust technique to indicate the firm's liquidity status.

**Keywords:** liquidity sustainability coefficient, necessary and sufficient conditions, financial efficiency ratio.

# Asset Misappropriation in Hospitality Industry as a Result of Weak Internal Control: A Content Analysis of 53 Cases

Ersem Karadag<sup>1</sup>, Sezayi Dumanoglu<sup>2</sup>, and Gulsah Sahin<sup>3</sup>

<sup>1</sup>School of Business  
Robert Morris University, USA  
<sup>2</sup>School of Social Sciences  
Marmara University, Turkey  
<sup>3</sup>Institute of Social Sciences  
Dogus University, Turkey

## Abstract

Asset misappropriation, a type of fraud is a major problem for organizations throughout the world. According to the ACFE Report of 2018, a typical organization loses 5% of its annual revenue to fraud. If this 5% loss estimate were applied to the 2017 estimated Gross World Product of \$79.6 trillion, it would result in a projected total global fraud loss of nearly \$4 trillion. This is only an estimated and, given the limitations, it is unlikely we will ever be able to calculate the true cost of fraud on a global scale (AFCE Report 2018). Asset misappropriation is one of the largest portion of fraudulent cases in almost every industry. Firms loses their financial and non-financial resources as a result of fraudulent activities involved by their employees. Fraud schemes reduces a firm's income and so that the company's net income is reduced by the total fraud loss. When an organization encounters such a loss due to fraud, a much more additional income is needed to restore net income to what it would have been without fraud. As a result, to recover the cost of the fraud, the organization would have to generate additional revenues of approximately ten times the cost of the fraud to restore the effect that the fraud had on net income. Studies conducted in many industries state that the major cause of fraud is weak internal control. Firms with a weak internal control are more susceptible to fraudulent asset misappropriation schemes (KPMG, 2004). Internal control weaknesses include lock of segregation of duties, physical safeguard, independent checks, proper authorization, proper documents and records, overriding existing controls, and inadequate accounting system (Albrecht, 2008). Association of Certified Fraud Examiners (ACFE) conducts fraud research worldwide since 1996, and publishes the "Report to the Nation on Occupational Fraud and Abuse". This report provides us many aspects of fraud in global bases, however industry based research in Hospitality area is somewhat limited. This paper put 53 hospitality industry fraud cases under the spotlight and analyze them in terms of the amount lost, characteristics of fraudster, and characteristics of the hospitality organizations faced with asset misappropriation.

**Keywords:** asset misappropriation, internal control, fraud, hospitality

## References

- ACFE (2018). Report to the Nations. (2018). Global Study on Occupational Fraud and Abuse. Accessed on April 17, from: <http://www.acfe.com/report-to-the-nations/2018/>
- Albrecht, C. & Kranacher, M-J., & Albrecht, S. (2018). Asset Misappropriation Research White Paper for the Institute for Fraud Prevention.
- KPMG (2004). Fraud Survey 2003, available at: [www.us.kpmg.com](http://www.us.kpmg.com) KPMG Forensic (2003)



# *Consumer Behavior*

# **A Cross-Cultural Study on Tourism: Strategies and Implications of Findings**

Sushant Kumar, Vishalwat Giridhar, Pradip H Sadarangani, and Bidyut J Gogoi

Indian Institute of Management Shillong, India

## **Abstract**

With the growth in new tourism destinations and dynamic nature of culture, the existing studies on culture and tourism are becoming less and less important in globalized world. This calls for a cross-cultural scholarly work which spans over many countries and employs a dynamic measure for growth in tourism industry. This paper aims to identify the favorable disposition of cultural factors towards tourism. The dimensions of culture are taken from Hofstede's model on culture and its relationship with tourism is arrived by using Travel and Tourism Competitiveness. The paper establishes the relationship by analyzing data from 73 countries. Individualism and long-term orientation are found to be favorable dimensions for development of tourism. Power distance and indulgence are also found to have a negative and positive relationship with tourism competitiveness. The paper outlines the broader strategies for the different group of countries which are classified under different clusters. The paper also highlights the policy implications of the study as designing culturally congruent policies leads to improvement in the competitiveness of tourism.

**Keywords:** travel, tourism, culture, cross-cultural study, travel and tourism competitiveness

# What Does the Customer of Café-Corner Expect From a Service Delivery?

Saloomeh Tabari<sup>1</sup>, Joanna Kuczevska<sup>2</sup>, Anne Conneally<sup>1</sup>, and Joanna Stefaniak<sup>2</sup>

<sup>1</sup>Department of Service Sector  
Sheffield Hallam University, United Kingdom

<sup>2</sup>Economics of European Integration Division Wydział Ekonomiczny  
Uniwersytet Gdański, Poland

## Abstract

*"We are what we repeatedly do. Excellence therefore, is not an act but a habit"*

*Aristotle*

As consumer desirables and expectations change, as well as the global hospitality industry changing, the question remains: what does the consumer of the service industry expect from the service delivery? As service delivery expectations increase, the hospitality industry is also experiencing many additional internal and external pressures to provide the right feeling in "creating moments" for their guests. This research aims to identify the needs of current and future customers' of this industry by discussing the dyadic relationship between service delivery and the change of customers' need from the industry. Previous to this, research has focused on the needs of current and future customers (Generation Y and Z) in two cities in Europe which they have more than one university.

**Keywords:** service delivery, current and future customers, customer's expectations, independent café, Sheffield, Sopot

## *Service Delivery and the Hospitality Industry*

Groonroos (2000, p. 331) mentions that the essence of a service delivery is very much associated with the employees: "everything a service organisation does for its customers is first perceived by its employees". Additionally, it is fundamental that organisations understand what the service delivery entails and how this should be managed. The service delivery can occur at two different levels - there are those who adopt an expertise-based strategy, by controlling the delivery process and expecting clients to adapt to their needs and style. If employees do not understand the wants of the customers and how the service offering can fulfil these wants, they will not be effective in their interaction with the customers. The industry is catering for and delivering a service to a variety of societal groupings; to include those who are well-travelled, well-educated and confident as consumers of a service delivery

## *Customer Expectations and Needs*

It is important for the service sector to have knowledge about customer expectations, according to Hayes there are two reasons: "understanding of how the customer defines quality of service and also facilitates the development of customer satisfaction questionnaires" (Hayes, 1997:7). Schiffman and Kanuk in their research have been highlighted the fact that expectations are shaped by four major factors: Personal needs, Word-of-mouth, past experience and External communication (Schiffman and Kanuk, 1991).

### *About Sheffield and Sopot*

Sheffield, a city and metropolitan borough in South Yorkshire, England and historically part of the West Riding of Sheffield has been called after the River Sheaf which runs through the city (<http://www.madeinsheffield.org/about-sheffield>). Sheffield is a home to more than 60,000 students. There are two big universities and few colleges are in the city (Sheffield Hallam and University of Sheffield, 2018). The city is attracting lots of international and domestic students because of these two universities.

Sopot is the resort city of around 40 thousands inhabitants. The city is placed in the Northern coast of Poland in the Pomeranian Region. Sopot is known as a health-spa and tourist resort destination in Poland visited by around two million tourist and holidaymakers each year. It is also the academic city.

There are two faculties of the University of Gdańsk located: the Faculty of Economics and the Faculty of Management with around 7.000 students all together. At present, these two Faculties are the largest faculties of the University of Gdańsk, enjoying vast popularity among secondary school graduates (<http://www.sopot.net/english.htm>).

These two cities are attracting lots of young generations because of educational opportunities which they are offering. Therefore demand for independent cafés is high and lots of small businesses are trying to attract this group of customers to their business. An important question that needs to be asked is: Are they ready for this segment and are they facilitating the needs to provide right feeling and "create moments" and right environment for this group as a current and future customers of hospitality and service industry?

### **Methodology**

The primary purpose of this research is to identify the needs of future customers of these two cities, in relation to the service delivery. To achieve the aim of this research, survey questionnaires have been designed to understand the relationship of proposed conceptual framework (figure1) and needs of customers from independents café in these two cities.

The café has been defined to participant as "café-corner which is supposed to be a cafeteria welcoming and serving students. The place desired for individuals (solo) and groups of students. The café-corner offers non-alcoholic drinks and it does not offer hot meals menu. The environment is working-friendly (Wi-Fi, possibility of printing, plugs to charge laptops, etc.) and long opening hours (9.00-20.00).

Data collection is taking place over 7 month timeframe (the result from pilot study n=100 will be presented) from 500 university student's Sheffield and Sopot as a current and future customer of industry (with regard to the nature of these two cities which they are accommodating more than 1 million students).

### **Discussion**

According to Lashley (2000 p.3) "hospitality requires the guest to feel that the host is being hospitable through feelings of generosity, a desire to please and a genuine regard for the guest as

an individual". The authors believe that hospitality and service delivery trends continue to change rapidly from traditional to modern way of hospitality due to the preference of modern day customers. The following conceptual framework has been proposed based on literature and pilot study.

The authors aim is to emphasis main needs of these groups of customers from industry and provide suggestion to hospitality and service industry of these two cities. The result of research could be generalised for other cities in Europe with same characteristics. The suggestion would be beneficial for managers of small business in Europe to understand the needs of their current and future target based on the market trends.

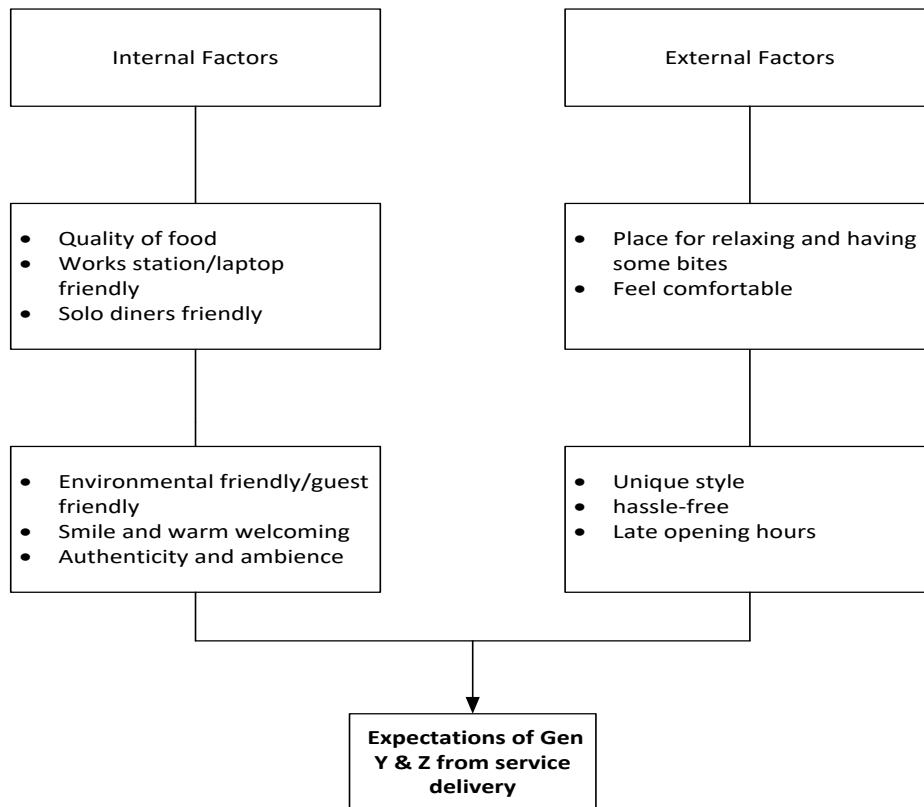

**Figure 1.** Conceptual framework

## References

- About Sheffield, <http://www.madeinsheffield.org/about-sheffield>, Accessed on March 2018.
- About Sopot, <http://www.sopot.net/english.htm>, Accessed on March 2018.
- Gronroos, C. (2000), *Service Management and Marketing*, 2nd ed., John Wiley & Sons Ltd, Chichester.
- Hayes, B.E. (1997), *Measuring Customer Satisfaction: Survey Design, Use, and Statistical Analysis Methods*, 2<sup>nd</sup> ed., ASQ Quality Press, Milwaukee, WI.
- Lashley, C. (2001), Towards a theoretical understanding, In C. Lashley, and A. Morrison (eds.), *In search of hospitality theoretical perspectives and debates*, Oxford: Butterwoth-Heinemann., pp. 1-16.

# Privacy Protection Proclivity and Trust: No Longer Concerns of Today's International M-Commerce Users?

Brent J. Cunningham, James L. Thomas, and Jianping Coco Huang

The School of Business and Industry  
Jacksonville State University, USA

## Abstract

As the diffusion of m-commerce reaches the late majority, do the barriers of acceptance during m-commerce's infancy still apply today? And do the same barriers exist across the global marketplace? Though phenomenal growth continues in the use of mobile devices, investigations of traditional barriers of use of m-commerce are limited. As corporations expand their m-commerce distribution and communication strategies both domestically and internationally, a deeper understanding of today's consumer use and nonuse must be established. Corporations seem to be making m-commerce strategy decisions utilizing assumptions based upon outdated user research. An investigation of the possible reprioritization of barriers to use of m-commerce by US and Chinese consumers and the role culture plays in the use of m-commerce is proposed. Some of the barriers to use proposed are privacy protection and trust, and the proposed cultural populations of interest are the US and China.

**Keywords:** China, US, e-commerce, smartphones, cell phone

## Introduction

The number of mobile phone internet users in the world at the end of 2017 was projected to surpass 2.73 billion. Of these 87.4% (or 2.39 billion) will access the internet utilizing a smartphone (eMarketer, 2017). The smartphone has now become the fastest and most widely spread technology in human history (DeGusta, 2012). The worldwide use of wireless telecommunications, more specifically the use of smartphones, has grown rapidly as people become increasingly dependent on email and remote access to corporate intranets and other Internet based services. Smartphones, once considered a luxury, are now taking the place of conventional telephones (land lines) in residential use and the family pc. Wireless networks have freed users from geographic restraints which have had them bound to desktop computers, enabled them to live, work and shop in more flexible and convenient ways utilizing multiple devices (Wagner, et al, 2013).

The significant growth of smartphone services is giving rise to a revolution in the business world. This revolution is focused on conducting business anytime and anywhere; accomplished through the advent of Mobile Commerce. Many researchers have defined Mobile Commerce (m-commerce) as simply a subset or extension of e-commerce, including all e-commerce transactions, carried out using a mobile (hand held) device (Sharma and Wildman, 2009; Ngai and Gunasekaran, 2007). Others purport m-commerce should be conceptualized as more than a mere extension of e-commerce due to discrepancies in interaction styles, usage patterns and value chains (Featherman et al 2010). The latter, more broad definition will be applied in this research. M-commerce is now providing enormous opportunities for business process innovation and location-sensitive services. However, in the rush to incorporate m-commerce into corporate strategies, organizations must try to gain an understanding of the consumer and their behavior toward m-commerce. For

example, identified and supported m-commerce use and nonuse variables from just a decade ago have not been investigated to ascertain relevance to today's digital marketplace consumer. Are the e-commerce use determinants of "risk management" (i.e., privacy protection) and "trust in the innovation" which have been generalized to all internet technologies like m-commerce and to all global markets still the major influencers they are assumed to be?

## **Literature Review**

This investigation will include samples from multiple international markets and several constructs. However, the researchers will focus on the US and Chinese markets and the following three constructs: M-commerce Privacy Proclivity, M-commerce Trust and M-commerce Intentions.

*Markets* - Though the diffusion of the smartphone/mobile phone in the world market has occurred quite rapidly, the investigation of this technology has not kept pace. The largest consumer markets, China with the greatest number of potential users and the US with the greatest potential of dollars spent, for m-commerce have not been considered in any thorough investigation. When investigating potential barriers to use of m-commerce many studies (Chang, et al, 2015; Blaise, et al, 2018; Yang, et al, 2015) tend to concentrate on one country (i.e., Malaysia, US, Singapore) and/or one consumer segment (i.e., younger citizens). Though reprioritization of barriers seemed to be identified by many studies, the generalization of the findings is extremely limited. Considering one of the worlds largest markets, India, when investigating barriers, Seam et al (2017) limited their focus to one aspect of m-commerce, the mobile wallet. Only the use of mobile wallet services was investigated internationally and not the barriers to use of m-commerce in general.

*Constructs* - M-commerce Privacy Proclivity - Consumer resistance to the use of innovation has consistently been referred to as barriers and markets can be and have been segmented based on these barriers (Laukkanen, et al, 2007). Segmentation dimensions identified for m-commerce nonusers or laggards have traditionally been usage barriers, value barriers, risk barriers, psychological barriers and image barriers. Due to uncertainty being inherent to innovations, risk barriers have consistently appeared at the top of reasons for m-commerce nonuse (Laukkanen, et al, 2007; Ram, et al, 2010). A highly observable risk barrier of m-commerce is Privacy Proclivity. M-commerce Privacy Proclivity is a behavior observed through the users: propensity to read of privacy policies; agreement to the m-commerce organizations handling of personal information; searches for privacy seals of approval; and providing false personal information. A sampling of scale items developed to observe such Privacy Proclivity behaviors are: Before I make an m-commerce purchase, I read the site's privacy policy. and If a site does not have a privacy seal of approval, I do not purchase any m-commerce products from that site.

M-commerce Trust - Consumers are becoming increasingly hesitant to provide complete information for digital transactions. This hesitancy is not unfounded considering the cases of identity theft and phishing scams (Korzaan, 2008). Consumer fears concerning Internet security and ordering over the Internet can influence online buying behavior (Cleff, Loris and Walter, 2015). With regard to M-commerce, the consumer presumes the digital shop will complete the transaction according to previously agreed terms without incident.

Trust implies the, “willingness of an individual to be vulnerable, reliance on parties other than oneself, or a person’s expectation” (Kim, Ferrin and Rao, 2008, p. 545). Thus, trust in a digital shop is the, “basic requirement in order to engage into a purchase decision through this online shop, irrespective of whether engaging into E-commerce or M-commerce” (Cleff *et al*, 2015).

Studies show nearly all consumers refuse to provide personal information to a digital shop at one time or another; a majority refuses because they lack trust. Most consumers are still not quite comfortable with the concept of Web-based business and the electronic medium itself. They are skeptical m-commerce can satisfy consumer needs unmet in the bricks-and-mortar business world, and they wonder whether m-commerce is technologically feasible and secure (Siau & Shen, 2003). College students are more willing to take risks and get involved with the new trends, even when they are not fully developed (Smith, 2014). Those who are highly intellectual are receptive to new ideas and experiences (Tsikriktsis, 2004). Also, individuals considered to be intellectual were more open to online purchasing and less concerned with privacy issues (Korzaan, 2008). However, some findings indicate that Web site certification can reassure potential customers, improve trust and increase the probability of purchase (Jiang, Jones and Javie, 2008).

Also, consumers have trust issues associated with conducting highly personal transactions over a cell phone. The trust issues can be attributed to two main areas, security and reliability. There are many factors that influence people’s concern over security. One such factor stems from the “cloning” of cell phones. This is when a non-working cell phone is reprogrammed to transmit the ESN/MIN of a legitimate cell phone (ESN/MIN is the unique number assigned to a cell phone). This causes the legitimate cell phone user to be billed for the charges of both phones (FCC, 2003). Another factor is distrust many Americans have with e-commerce and the internet in general. It is only natural for them to translate this distrust to m-commerce (Coursaris, 2001). From this uncertainty, it is a small step for consumers to doubt the integrity of digital vendors (Siau & Shen, 2003).

Researchers Comer, Plank, Reid and Pullins (1999) developed an effective trust measure for the B2B marketplace which identifies three trust components: Person, Product and Company. Since all e-commerce (which includes m-commerce) digital transactions eliminate the person, digital shopper trust has been found to be based on product and company trust components.

M-commerce Intentions - A simple replication of Gefen and Straub’s 2004 B2C study of e-commerce users purchase intent instrument was utilized in this study. This state-of-the-art, highly replicated instrument consists of just two items: I am very likely to purchase products using mobile technology; and I would be comfortable using my credit card to purchase products using mobile technology.

Demographics - Methods for building trust for m-commerce transactions can vary according to demographic differences (i.e., gender, age). Traditionally, women drive shopping trends. However, women are less likely to spend time online, and therefore shop less online (Urbanski, 2015). Men and women perceive m-commerce in different ways, and possess different levels of trust. Men are more pragmatic when making digital purchases, while women are more emotive (Awad, 2008). Providing a tangible experience and personal interaction with an employee is a major component of trust (Thakur, 2007), and women are less likely to trust the online environment (Awad, 2008).



The age or stage in life of potential adopters appears to influence the manner in which the mobile device users balanced the expenses and conveniences associated with mobility. (Eze & Poong, 2014) Millennials, consumers aged 18 to 34, spend more money online than any other age group. Boomers and seniors are become quite mobile-savvy with one in four mobile shoppers in the U.S. being over the age of 55. Though they have relatively low incomes, Generation Z, 18 to 24 year olds, spend 9% of their annual income online (Smith, 2014).

## **Methodology**

Hypotheses, data collection, sample, and empirical model will be discussed.

### *Hypotheses*

Given the prior research examined in the literature review, the following hypotheses are proposed.

- H<sub>1</sub>: Privacy proclivity has a negative relationship with m-commerce intention.
- H<sub>2</sub>: Privacy proclivity has a negative relationship with m-commerce Trust.
- H<sub>3</sub>: M-Commerce Trust has a positive relationship with m-commerce intention.
- H<sub>4</sub>: The negative relationship between privacy proclivity and m-commerce intention is stronger in China than in the U.S.
- H<sub>5</sub>: The negative relationship between privacy proclivity and m-commerce trust is stronger in China than in the U.S.
- H<sub>6</sub>: The negative relationship between privacy proclivity and m-commerce trust is stronger in men than in women
- H<sub>7</sub>: The negative relationship between privacy proclivity and m-commerce trust is stronger in Gen X than other age groups.

### *Data Collection*

Data for the study will be gathered by means of a self-administered, multi-page electronic questionnaire. An English version will be utilized to collect data from a student population on a southeastern United States university and from an adult population in a southeastern state in the United States. And, a Chinese version will be utilized to collect data from the student population on three Universities in China and from the adult population in proximity to these same three Universities. The planned data collection period is May 2018 through September 2018. The study has already received the Institutional Review Board (IRB) approval from each of the universities involved. Subjects will have access to a copy the University's IRB approval of the study via a hyperlink in the Introduction section of the questionnaire.

### *Sample*

The researchers have established a sample size goal of 500 US respondents and 500 Chinese respondents. While these samples do constitute convenience samples, it has been noted (Ferber 1977; Cardy 1991) that such samples are appropriate under the following conditions. First, the items being investigated must be pertinent to the respondents who are questions, and second, the study must be exploratory in nature. This study will examine issues quite applicable to college students (mobile commerce, trust, and privacy protection), and it is one of the first to examine how

the impact upon mobile commerce intentions by trust and privacy protection have changed over time and across cultures.

### *Empirical Model*

**Questionnaire** - The questionnaire consists of questions designed to measure m-commerce behavior, whether the respondents take steps to protect their own privacy online (Privacy Protection Proclivity), Trust in M-Commerce, and m-commerce intentions. Each of the scales have been developed, tested and validated in previously-conducted studies. The demographic information being collected includes items such as gender, year of birth, marital status, residency, etc.

**Scale Items** - The constructs being examined in this study include Privacy Protection Proclivity, M-commerce Trust, and M-commerce Intentions. Each of the scales were previously developed, tested, and validated. Only minor modifications have been made for the purposes of the study at hand. Each construct will be measured utilizing a 5-point Likert-type scale. A 1 indicates the respondent's strong disagreement with a particular statement, while a 5 indicates strong agreement.

Before testing of the study hypotheses, reliability and principal components factor analyses will be conducted to determine whether the scales used are appropriate. Assessment of the scales, following Churchill's (1979) eight-step process, will involve reliability assessment through the use of coefficient alpha (Cronbach 1951). Principal components factor analysis will be used with varimax rotation to determine the minimum number of factors accounting for variance within each measure. The loading of a scale item on any factor will be indicated by a minimum value of 0.40; and as suggested by Hair, Anderson, Tatham, and Black (1992), a minimum Eigenvalue of one will be used as a criterion for creating dimensions. Following purification of the scales, final Cronbach's (1951) alphas will be calculated. Ideally, the coefficient alpha for a purified scale should exceed 0.70 (Nunnally 1978). Once the purification of the scales is completed, each variable will be summated and standardized to allow efficient testing of the study's hypotheses.

### **Findings**

The results of this proposed research will fill two significant gaps: 1.) Managers are making m-commerce decisions based on two-decade-old information. Are the barriers to use of m-commerce the same today as they were twenty years ago?; and 2.) Is the result of m-commerce research in the United States generalizable to other countries? Is culture a moderating variable in the barriers to use and m-commerce use intentions relationships?

### **References**

- Aaker, D. A., & Bagozzi, R. P. (1979). Unobservable variables in structural equation models with an application in industrial selling. *Journal of Marketing Research*, 147-158.
- Awad, N. F., & Ragowsky, A. (2008). Establishing trust in electronic commerce through online word of mouth: An examination across genders. *Journal of Management Information Systems*, 24(4), 101-121.
- Belk, R. W. (1984). Three scales to measure constructs related to materialism: Reliability, validity, and relationships to measures of happiness. *ACR North American Advances*.
- Blaise, R., Halloran, M., & Muchnick, M. (2018). Mobile commerce competitive advantage: A quantitative study of variables that predict m-commerce purchase intentions. *Journal of Internet Commerce*, 17(2), 96-114.
- Colin, C. (1987). *The romantic ethic and the spirit of modern consumerism*. Basic Blackwell: Oxford, UK.
- Cardy, R. L. (1991). The applied value of laboratory research. *Management Communication Quarterly*, 5(1), 111-119.

- Chan, F. T., & Yee-Loong Chong, A. (2013). Analysis of the determinants of consumers' m-commerce usage activities. *Online Information Review*, 37(3), 443-461.
- Chang, S. C., Sun, C. C., Pan, L. Y., & Wang, M. Y. (2015). An Extended TAM to Explore Behavioral Intention of Consumers to Use M-Commerce. *Journal of Information & Knowledge Management*, 14(02), 1550014.
- Churchill Jr, G. A. (1979). A paradigm for developing better measures of marketing constructs. *Journal of marketing research*, 64-73.
- Cleff, T., Loris, H., & Walter, N. (2015). Shopping On The Go-An Analysis Of Consumers' Intention To Use M-Commerce In Germany And Peru. *Interdisciplinary Management Research*, 11, 344-372.
- Comer, J. M., Plank, R. E., Reid, D. A., & Pullins, E. B. (1999). Methods in sales research: perceived trust in business-to-business sales: a new measure. *Journal of Personal Selling & Sales Management*, 19(3), 61-71.
- Coursaris, C., & Hassanein, K. (2002). Understanding m-commerce: a consumer-centric model. *Quarterly journal of electronic commerce*, 3, 247-272.
- Cronbach, L. J. (1951). Coefficient alpha and the internal structure of tests. *psychometrika*, 16(3), 297-334.
- Cunningham, B. J., Borstorff, P. & J. L. Thomas (2006). Influencers impacting the diffusion of m-commerce activities among final consumers. In 31<sup>st</sup> Annual Atlantic Marketing Association Conference proceedings (pp. 107-112). Portland, Maine.
- Cunningham, B. J. & J. L. Thomas (2003). Explicating materialism in the service sector. In the Marketing in a Dynamic Global Environment Atlantic Marketing Association 2003 Conference proceedings (pp. 152-159). Savannah, Georgia.
- Cyr, D. (2008). Modeling web site design across cultures: relationships to trust, satisfaction, and e-loyalty. *Journal of Management Information Systems*, 24(4), 47-72.
- Dabholkar, P. A., & Bagozzi, R. P. (2002). An attitudinal model of technology-based self-service: moderating effects of consumer traits and situational factors. *Journal of the academy of marketing science*, 30(3), 184-201.
- DeGusta, M. (2012). Are smart phones spreading faster than any technology in human history?. MIT Technology Review, May 9, Business Report Page.
- Elgin, D. (1981). *Voluntary Simplicity*, New York: Morrow.
- eMarketer Updates Worldwide Internet and Mobile User Figures. (December 1, 2017). Retrieved from <https://www.emarketer.com/content/emarketer-updates-worldwide-internet-and-mobile-user-figures>
- Eze, U. C., & Poong, Y. S. (2013). The Moderating Roles of Income and Age in Mobile Commerce Application. *Journal of Electronic Commerce in Organizations (JECO)*, 11(3), 46-67.
- Featherman, M. S., Miyazaki, A. D., & Sprott, D. E. (2010). Reducing online privacy risk to facilitate e-service adoption: the influence of perceived ease of use and corporate credibility. *Journal of Services Marketing*, 24(3), 219-229.
- Ferber, R. (1977). Research by convenience. *Journal of Consumer Research*, 4, 57-8.
- Friesen, G.B. (2002). M-commerce mmm-good?. *Consulting to Management*, 13, 26-29.
- Gatignon, H., & Robertson, T. S. (1985). A propositional inventory for new diffusion research. *Journal of consumer research*, 11(4), 849-867.
- Gefen, D., & Straub, D. W. (2004). Consumer trust in B2C e-Commerce and the importance of social presence: experiments in e-Products and e-Services. *Omega*, 32(6), 407-424.
- Haque A. (2004). Mobile commerce: costumer perception and it's prospect on business operation in Malaysia. *The Journal of American Academy of Business*, March, 257-262.
- Hirschman, E. C. (1980). Innovativeness, novelty seeking, and consumer creativity. *Journal of consumer research*, 7(3), 283-295.
- Holt, D. B. (1995). How consumers consume: A typology of consumption practices. *Journal of consumer research*, 22(1), 1-16.
- Im, S., Bayus, B. L., & Mason, C. H. (2003). An empirical study of innate consumer innovativeness, personal characteristics, and new-product adoption behavior. *Journal of the Academy of Marketing Science*, 31(1), 61-73.
- Jiang, P., Jones, D. B., & Javie, S. (2008). How third-party certification programs relate to consumer trust in online transactions: An exploratory study. *Psychology & Marketing*, 25(9), 839-858.
- Jih, W. J. K., & Lee, S. F. (2004). An exploratory analysis of relationships between cellular phone uses' shopping motivators and lifestyle indicators. *Journal of Computer Information Systems*, 44(2), 65-73.
- Kim, D. J., Ferrin, D. L., & Rao, H. R. (2008). A trust-based consumer decision-making model in electronic commerce: The role of trust, perceived risk, and their antecedents. *Decision support systems*, 44(2), 544-564.
- Korzaan, M. L., & Boswell, K. T. (2008). The influence of personality traits and information privacy concerns on behavioral intentions. *Journal of Computer Information Systems*, 48(4), 15-24.

- Laroche, M., Bergeron, J., & Goutaland, C. (2001). A three-dimensional scale of intangibility. *Journal of Service Research*, 4(1), 26-38.
- Laroche, M., Bergeron, J., & Goutaland, C. (2003). How intangibility affects perceived risk: the moderating role of knowledge and involvement. *Journal of services marketing*, 17(2), 122-140.
- Laukkanen, T., Sinkkonen, S., Laukkanen, P., & Kivijarvi, M. (2008). Segmenting bank customers by resistance to mobile banking. *International Journal of Mobile Communications*, 6(3), 309-320.
- Lin, C. H. & S. F. Yu (2006). Consumer adoption of the internet as a channel: the influence of driving and inhibiting factors. *The Journal of American Academy of Business*, 9 (2), 112-117.
- Manning, K. C., Bearden, W. O., & Madden, T. J. (1995). Consumer innovativeness and the adoption process. *Journal of Consumer Psychology*, 4(4), 329-345.
- Midgley, D. F., & Dowling, G. R. (1978). Innovativeness: The concept and its measurement. *Journal of consumer research*, 4(4), 229-242.
- Moschis, G. P. (1981). Patterns of consumer learning. *Journal of the Academy of Marketing Science*, 9(2), 110-126.
- Ngai, E. W., & Gunasekaran, A. (2007). A review for mobile commerce research and applications. *Decision support systems*, 43(1), 3-15.
- Nunnally, J.C. 1978. *Psychometric Theory*, New York: McGraw-Hill.
- Parasuraman, A. (2000). Technology Readiness Index (TRI) a multiple-item scale to measure readiness to embrace new technologies. *Journal of service research*, 2(4), 307-320.
- Ram, S., & Sheth, J. N. (1989). Consumer resistance to innovations: the marketing problem and its solutions. *Journal of Consumer Marketing*, 6(2), 5-14.
- Richins, M. L., & Dawson, S. (1992). A consumer values orientation for materialism and its measurement: Scale development and validation. *Journal of consumer research*, 19(3), 303-316.
- Rogers, E. M. (2003). *Diffusion of Innovations*. New York: The Free Press.
- Sarker, S., & Wells, J. D. (2003). Understanding mobile handheld device use and adoption. *Communications of the ACM*, 46(12), 35-40.
- Seam, A., Reddy, R. S., Agrawal, S., Chaitanya, B. K., Bist, H., Safdar, S., ... & Rao, P. H. (2017). factors affecting consumer's choice to use mobile wallet to access m-commerce industry in india.
- Shama, A., & Wisenblit, J. (1984). Values of voluntary simplicity: Lifestyle and motivation. *Psychological Reports*, 55(1), 231-240.
- Sharma, R. S., & Wildman, S. (2009). The economics of delivering digital content over mobile networks. *Journal of Media Business Studies*, 6(2), 1-24.
- Siau, K., & Shen, Z. (2003). Building customer trust in mobile commerce. *Communications of the ACM*, 46(4), 91-94.
- Sinkovics, R. R., Stöttinger, B., Schlegelmilch, B. B., & Ram, S. (2002). Reluctance to use technology-related products: Development of a technophobia scale. *Thunderbird International Business Review*, 44(4), 477-494.
- Smith, Cooper (2014). 7 statistics about e-commerce shoppers that reveal why many consumer stereotypes don't apply online. *Business Insider*, August.
- Thakur, R., & Summey, J. H. (2007). e-Trust: Empirical insights into influential antecedents. *Marketing Management Journal*, 17(2), 67-80.
- Tsikriktsis, N. (2004). A technology readiness-based taxonomy of customers: A replication and extension. *Journal of Service Research*, 7(1), 42-52.
- Urbanski, A. (2015). Men now biggest online shoppers. *Direct Marketing News*, April 2.
- Varshney, U. (2003). Mobile and wireless information systems: applications, networks, and research problems. *Communications of the Association for Information Systems*, 12(1), 11
- Wagner, G., Schramm-Klein, H., & Steinmann, S. (2013). Effects of cross-channel synergies and complementarity in a multichannel e-commerce system—an investigation of the interrelation of e-commerce, m-commerce and IETV-commerce. *The international review of retail, distribution and consumer research*, 23(5), 571-581.
- Yang, K. C., Chye, G. N. S., Fern, J. C. S., & Kang, Y. (2015). Understanding the Adoption of Mobile Commerce in Singapore with the Technology Acceptance Model (TAM).
- In *Assessing the Different Roles of Marketing Theory and Practice in the Jaws of Economic Uncertainty* (pp. 211-215). Springer, Cham.
- Yeo, J., & Huang, W. (2003). Mobile e-commerce outlook. *International Journal of Information Technology & Decision Making*, 2(02), 313-332.

# Consumer Evaluation of Celebrity Brand Extensions: An Affect Transference Perspective

Tracy H. Kizer

Crummer Graduate School of Business  
Rollins College, United States

## Abstract

This study employs Aaker and Keller's (1990) brand extension model as a theoretical framework to examine consumer response to celebrity brand extensions. Celebrities are enhancing their brand value by leveraging the infamy of their names through brand extensions. Celebrity-brand extensions, conceptualized as products developed and marketed by celebrities; represent one of the most explosive branding trends in the marketplace. From 2005 to 2017, more than four thousand celebrity brand extensions, ranging from clothing to financial products were introduced into retailers such as Macy's, H&M, Sears and JC Penney's, and Kohl's. Macy's 2007 Star campaign featured over 25 celebrities and entertainers whose branded merchandise retailed at their stores nationwide. In 2015, over 15% of all Macy's revenue was comprised of human-brand extensions (Annual Report 2009). Thus, the proliferation of celebrity brand extensions is expected to continue as consumers seek to connect with celebrities through their extensions.

Critical to the success of human-brand extensions is the degree to which meaning transference occurs from the celebrity to their extension. When a celebrity's brand extension is consistent with their domain of expertise, meaning transference processes causes consumers to evaluate the extensions more favorably. This prediction is similar to findings by Park, Milberg and Lawson (1991) who found that consumers tend to evaluate brand extensions more favorably when the parent brand and the extension share the same category. Broniarczyk and Alba (1994) found that consumer perceptions of brand extensions were influenced by brand-specific associations, which dominated brand affect and category similarity, when consumer knowledge of the brand was considered high. Together, the findings by Park, Millberg, and Lawson (1991) and Broniarczyk and Alba (1994) suggests human brand extensions are evaluated to the degree to which the extension is similar to the celebrity's domain of infamy and how relevant and desirable celebrity-specific associations are to the extension category. This argument frames the central premise of the research. Transference between consumer's perceptions of the celebrity and their brand extensions has yet to be explored. Thus, the aim of this research is to model a response of consumer response to celebrity brand extensions. Study 1 is a qualitative study of consumers' responses and Study 2 is an experimental study that examines positioning strategies of human brand extensions.

Celebrities can have a wide array of associations that can potentially be transferred to their extensions. Similar to traditional brands that have unique associations within their product class; celebrities have specific associations that differentiate them from other celebrities in their field. These associations are oftentimes derived from their domain of expertise. For example, Michael Jordan is known as the greatest basketball player of all time. Hank Aaron was known as the "Hammer" of baseball and Michael Jackson was known as the "King of Pop". Such specific associations can prove valuable for celebrities who develop brand extensions. Chakravarti, MacInnis and Nakamoto (1990) defined brand-specific associations as an attribute or benefit that differentiates a brand from competing brands. Whereas Aaker (1991) suggested that brand image

is equivalent to brand associations, those items in one's memory linked to a brand. Keller (1993) conceptualized brand associations as having both function and psychological benefits. The various conceptualizations of brand associations are well cited. However, because celebrities pride themselves on differentiation and image, the research employs components of both MacInnis and Nakamoto's (1991) and Aaker's (1991) definitions of brand associations. Therefore, a celebrity-specific association is defined as an association that differentiates one celebrity from another celebrity. Such associations collectively frame a celebrities' brand image, which is consistent with Aaker's (1993) image-based view of brand associations.

### *Study 1*

*Procedure.* Two pretests were conducted to identify the celebrities and their brand extensions based on frequency of occurrence. Subjects were invited to identify celebrities that were relevant to their peer groups, along with appropriate extensions fitting for the celebrity. Fifty-four respondents participated across both pretests. Following this, study one involved 148 participants taking 30 seconds to write down the associations or thoughts that came to mind when they thought of the celebrity and their brand extensions. Next, the extensions were rated on three fit measures, along with other celebrity-based variables.

*Findings.* Celebrities were associated with attributes relevant to their domain of expertise, as their personal life and physical attributes. Contrary to traditional brands which may not readily be associated with their parent company; celebrity brands were most commonly associated with significant others (e.g. spouse). Brand extensions receiving high evaluations revealed that most participants agreed to the celebrity launching a brand extension based on their professional domain. Brand extensions receiving low evaluations were largely due to the brand extension being beyond the celebrity's domain of expertise, as well as the unlikeable nature of the celebrity, a form of negative brand affect transference. Regression analysis revealed favorable attitude towards the celebrity is related to evaluations of the brand extensions when fit is established between the celebrity and their extension based on similarity. The standardized regression coefficients for SIMILARITY, COMPLEMENT, and SKILLSET were 0.22, 0.05, and 0.47, all significant at the  $p < .01$  level. The results suggest that SIMILARITY and SKILLSET are the most important variables in consumer's evaluation of human-brand extensions.

### *Study 2*

*Procedure.* Extending the findings of study 1, study 2 examined consumer response to celebrity brand extensions by varying positioning strategies and introducing extension cues. Ninety-six respondents participated in this study. The design was a repeated measures, 2 x 2 factorial design with two between-subject factors, quality cues about the manufacturer (present or absent) and brand extension attribute elaboration (present or absent). The cues signified that the extension was developed and/or manufactured by a reputable company who is a lead provider in the extension's product category. The attribute elaborations were brief descriptions of an attribute that subjects had repeatedly expressed concern for in study 1. The procedure was similar to that in study 1, with a few minor differences. Only, the low-rated brand extensions were used as stimuli, and two filler extensions were added.

*Findings.* The main effect for attribute elaboration was significant,  $F(1, 343) = 3.92, p < .049$ . Attitudes towards the brand extension were enhanced when the attribute was elaborated upon. Regression analyses showed the use of a cue appears to minimize the importance of the brand extension complementing the celebrity. That is, when the manufacturer's cue is present, the belief of whether or not the extension complements the celebrity is minimized. The use of attribute elaboration as a positioning strategy lessens the importance of a celebrity possessing the skills to develop the extension.

*Conclusion.* The research presented here provides evidence for the importance of celebrity-specific associations, which extends consumer response to celebrity brands beyond the attachment perspective (Thomson, 2007; Fournier 1998). Celebrity-specific associations were shown to influence consumer evaluations and associations of brand extension fit. Lack of perceived similarity with the celebrity's area of expertise was a primary challenge for brand extensions rated poorly by participants. Celebrities looking to capitalize on their brand equity by should developing brand extensions that are similar to their domain of expertise. Thus, opportunities to capitalize on a celebrity's brand image are limited to similar extension categories.

**Keywords:** brand-extensions, celebrities, affect

## References

- Aaker, D. A., & Equity, M. B. (1991). Capitalizing on the Value of a Brand Name. *New York*, 28, 35-37.
- Broniarczyk, S. M., & Alba, J. W. (1994). The importance of the brand in brand extension. *Journal of Marketing Research*, 31(2), 214-228.
- Chakravarti, D., MacInnis, D. J., & Nakamoto, K. (1990). Product category perceptions, elaborative processing and brand name extension strategies. *ACR North American Advances*, 17, 910-916.
- Fournier, S. (1998). Consumers and their brands: Developing relationship theory in consumer research. *Journal of Consumer Research*, 24(4), 343-373.
- Keller, K. L. (1993). Conceptualizing, measuring, and managing customer-based brand equity. *The Journal of Marketing*, 57(1), 1-22.
- Park, C. W., Milberg, S., & Lawson, R. (1991). Evaluation of brand extensions: The role of product feature similarity and brand concept consistency. *Journal of Consumer Research*, 18(2), 185-193.
- Thomson, M. (2006). Human brands: Investigating antecedents to consumers' strong attachments to celebrities. *Journal of Marketing*, 70(3), 104-119.

# The Comparison of Asian and Non-Asian Business Travelers' Hotel Service Preferences

Faranak Memarzadeh<sup>1</sup> and Sulekha Anand<sup>2</sup>

<sup>1</sup>College of Applied Sciences & Arts

<sup>2</sup>College of Science

San Jose State University, USA

## Abstract

Identifying the Asian business travelers' specific expectations of hotel service, provides a clear picture of Asian travelers' preferred service patterns. Understanding guests' expected level of quality and the way they assess the received service will support the guest's re-patronage intention (Yap & Kew, 2007). The assessments of importance for the following characteristics were higher for Asian business travelers: multi-lingual staff, availability of adequate transportation to the hotel, availability of gym/workout facilities, hotel is part of a reputable chain, presence of business-related meeting rooms, presence of a business center, in-room mini-bar, and food and beverage are a value for the money. Since the lodging market for Asian business travelers is growing fast, it is essential for hoteliers to recognize the unique characteristics of this large market segment. The outcomes of this study can benefit hoteliers in identifying and addressing Asian business travelers' desired hotel service.

**Keywords:** hotel service, expectancy, Asian business traveler

## Introduction

Previous studies have investigated culture-based preferences in the assessment of service quality in both the hotel and restaurant industries. The aim of the present study was to determine whether Asian business travelers have a particular expectation of hotel service. The results of this study can benefit hotel managers in recognizing and addressing Asian business travelers' expectations.

## Literature Review

Despite a number of studies that have examined the racial and social aspects of the hotel industry, there is a dearth of studies addressing the influences of ethnicity and race on business travelers' expectations of hotel service. Business travelers are powerful customers in the hotel industry (Furrer, Liu & Sudharshan, 2000), who travel frequently (Knutson, 1988), and are prepared to pay more for the expected service (Barsky & Nash, 2003). Understanding by the hotel industry of customers' desired level of quality and the way they evaluate the received product or service will strengthen the customer's re-patronage intention as Yap & Kew (2007), believe. Mattila (2000) claims that social interaction is a fundamental characteristic of the service industry which is introduced through a cultural context, meaning that knowledge of cultural factors can confer a competitive advantage in the service industry (Riddle 1992). According to previous studies, Asian travelers pay more attention to quality of service but care less about room quality (Li, Law, Vu & Rong 2013); therefore Asian travelers have not been found to exhibit preferences for location, sleep, room, cleanliness, and value for the money. The current study is a comprehensive investigation on the hotel facilities and services that are valued by Asian business travelers.



## **Methodology**

A self-administered online survey was used to evaluate whether ethnicity affects business travelers' expectations of hotel service. The survey questions were extracted from studies such as Sparks & Browning (2010), Chu & Choi (2000), and Lee & Sparks (2007). Business travelers who had hotel stay experiences in United States hotels in the six months prior to distribution of the online survey were the targeted contributors. Three hundred qualified respondents were selected using Qualtrics for this study. Some of the hotel characteristics evaluated in the survey were: reservation and check-in/check-out services, safety and security of the hotel, service- and service provider-related characteristics, comfortable bedding, value for the money, hotel facilities, hotel location, gym/workout facilities, and more. For each question, respondents rated the importance of the characteristic on a 7 point Likert scale, with 1 representing Strongly Disagree and 7 representing Strongly Agree.

SPSS version 24 was used to perform a two sample t-test comparing the responses to each question between Asians and other ethnicities. Ethnicity (Asian vs. not Asian) was the independent variable and rating of the hotel characteristic's importance was the dependent variable. If the assumption of equal variances was not met for a t-test, the Welch's approximation was used to determine statistical significance for that t-test.

## **Findings**

There were 38 respondents who were Asian and 262 who were not Asian. The ratings of importance were higher for Asian business travelers compared to non-Asian business travelers for the following characteristics: multi-lingual staff, availability of adequate transportation to the hotel, availability of gym/workout facilities, hotel is part of a reputable chain, presence of business-related meeting rooms, presence of a business center, in-room mini-bar, and food and beverage are a value for the money.

The findings of the current study indicate the importance of in-property amenities for Asian travelers. For instance, an in-room mini bar, with a mean rating of importance of 5.66 out of 7, was an important factor for Asian compared to other business travelers (mean 4.39). In addition, multi-lingual staff (mean of 5.32) was important for Asian business travelers. Workout facilities, business-related meeting rooms and in-property meeting rooms were also valued by Asian business travelers.

## **Conclusions**

Understanding the desires of different ethnic groups and cultures can help service providers address the needs of different business travelers. The lodging market for Asian business travelers is growing quickly and it is essential for service providers to understand the unique characteristics of this large market segment. Hoteliers and management teams can utilize the findings of the current study to target guests' preferences, which is an important component of assuring that guests are valued.

## References

- Barsky, J., & Nash, L. (2003). Customer satisfaction: Applying concepts to industry-wide measures. *Cornell Hotel and Restaurant Administration Quarterly*, 44(5-6), 173-183.
- Chu, R. K., & Choi, T. (2000). An importance-performance analysis of hotel selection factors in the hong kong hotel industry: A comparison of business and leisure travelers. *Tourism Management*, 21(4), 363-377.
- Furrer, O., Liu, B. S. C., & Sudharshan, D. (2000). The relationships between culture and service quality perceptions: Basis for cross-cultural market segmentation and resource allocation. *Journal of service research*, 2(4), 355-371.
- Knutson, B. J. (1988). Frequent travelers: Making them happy and bringing them back. *The Cornell Hotel and Restaurant Administration Quarterly*, 29(1), 82-87.
- Lee, Y. L., & Sparks, B. (2007). Appraising tourism and hospitality service failure events: a Chinese perspective. *Journal of Hospitality & Tourism Research*, 31(4), 504-529.
- Li, G., Law, R., Vu, H. Q., & Rong, J. (2013). Discovering the hotel selection preferences of Hong Kong inbound travelers using the Choquet Integral. *Tourism Management*, 36, 321-330.
- Mattila, A. S. (2000). The impact of culture and gender on customer evaluations of service encounters. *Journal of Hospitality & Tourism Research*, 24(2), 263-273.
- Riddle, D. (1992). Leveraging cultural factors in international service delivery. *Advances in Services Marketing and Management*, 1(1), 297-322.
- Sparks, B. A., & Browning, V. (2010). Complaining in cyberspace: The motives and forms of hotel guests' complaints online. *Journal of Hospitality Marketing & Management*, 19(7), 797-818.
- Yap, S. F., & Kew, M. L. (2007). Service quality and customer satisfaction: antecedents of customer's re-patronage intentions. *Sunway Academic Journal*, 4, 59-73.

# *Economics*

# Do Superfund Sites Cause Superwages?

Jeff Felardo

Collegium of Behavioral and Social Sciences  
Eckerd College, United States

## Abstract

Since the passing of the superfund legislation, the Comprehensive Environmental Response, Compensation, and Liability Act of 1980 (CERCLA), superfund waste sites have become an important topic for governments, environmentalists, local residents, and economists. The superfund program was created because the government thought that the benefits of cleaning up these sites would outweigh the costs. Some would argue that before the legislation was passed, companies could create these hazardous sites because of a market failure, namely non-perfect information. But now that we do have perfect, or better information how the harm caused by these sites, what is the best course of action? The costs associated with cleaning up these sites are huge, and the damage that they impose may already be captured in the local economy through housing prices and job wages.

This paper is going to focus on the interaction between superfund sites and their effect on local resident's wages. Theory suggests that people residing close to dangerous or hazardous sites will need to be compensated in some form to live there, as opposed to a very similar location without these undesired sites. This theory relies on two assumptions. The first assumption is that workers are perfectly mobile, and in general workers do have the choice to move and switch jobs, even if they do not always have the means. The second assumption is that workers have perfect information about their job characteristics and the area that they live. This assumption is more of a stretch because of the asymmetry in information that exists between workers and their firms.

There are several intuitive explanations for how proximity to superfund sites may influence wages based on compensating wage differential theory. While many housing price hedonic models have been looked at using superfund data, no studies have looked at their influence on wages, or used a dataset of the magnitude of the American Community Survey (ACS). This key contribution of this paper is to look at the possibility of wages being affected by superfund sites, and to perform this analysis at a macro country wide (United States of America) scope. While looking at one city will give a more accurate analysis of how a superfund site affects wages, looking at the macro picture will give a more general idea, and takes advantage of the large data set provided by the ACS.

Many studies have been done looking at the costs and benefits of superfund sites existence as well as their possible clean up. Most studies have focused analyzing the benefits accrued from the cleanup of sites (mostly relating to health, and possibly housing values) and compares them to the costs of administering the clean ups (Hamilton & Viscusi, 1999). Other studies look at the effect that superfund sites have on housing prices through a hedonic house pricing model values (Gayer, Hamilton, & Viscusi, 2000; Greenstone & Gallagher, 2008; Noonan, Krupka, & Baden, 2007; Noonan, Turaga, & Baden, 2009; Walker, 1992; Zuideau & Letombe, 2008). Some of these studies agree with the idea that location to the site matters while others do not. Most involve case studies for specific cities.

The study by Noonan et al. (2007) finds that the cleanup of a superfund site has no direct effect on the prices of housing in the general area. However, there are positive effects in indirect prices such as residential sorting and neighborhood investment. They also find that the results are sensitive to policy endogeneity and model specification. This is caused because governments are more likely to cleanup “richer” areas because of political pressure and these areas may already have high property values.

The paper by Greenstone and Gallagher (2008) find that the cleanup associated with superfund sites has no statistical significance in changing housing prices. They state this conclusion using a myriad of tests and model structures and find that the predicted price increase is substantially lower than the average cost of cleanup estimated at 42 million dollars. Their result may be the case of only looking at sites that were cleaned up. A potential future paper could look at the housing price differences before the discovery or labeling of a superfund site and after.

Gayer et al. (2000) finds that residents are willing to pay a premium to live in areas that do not have superfund sites nearby. They use a Bayesian learning model merged into a hedonic framework to estimate the willingness to pay by residents to live in not affected areas. They also find that residents’ willingness to pay to avoid risks caused by living near these sites decreases after the release of information pertaining to risk values associated with the sites. This implies that perfect information about the risks associated with these sites was not present before the legislation was passed, and also points to the possibility that complete information is still not present.

There has been analysis on environmental amenities and their effect on wages and housing prices. The paper by Hand et al. (2008) shows that residents who reside close to forests receive a lower annual wage than those who live further away. They find that the combination of housing and wage differentials can be used to price the forests at about 30 dollars per square mile annually. Their approach is unique in that they estimate wage and housing hedonics separately and aggregate their values to estimate a value for the forest. Their results show that environmental amenities or dis-amenities can change local residents’ wages.

This paper is novel because it is looking at the effect that superfund sites have on wages for people living near them. It will also encompass all large cities in the United States, and will have a substantially larger dataset than most other studies. The model will use data from the American Community Survey consisting of over 3,000,000 observations. Because of the geographical anonymity required for this type of survey, roughly 10 percent of these observations were in identifiable cities. This information of location can be tied to superfund site information, where the superfund sites are located within the recorded city.

While statistically significant, the economic significance of residing near Superfund sites is relatively low (about \$250 per superfund site). The first possibility of why superfund sites do not significantly affect wages in their area is because the negative externality of the superfund site is already accounted for in housing prices. This line of thought would support the past research which has shown superfund sites do have an impact on local house values (Gayer et al., 2000; Greenstone & Gallagher, 2008; Noonan et al., 2007; Noonan et al., 2009; Walker, 1992; Zuideau & Letombe, 2008). The second is the possibility that workers have little knowledge of how many superfund sites there are nearby—and how dangerous they may be.

Other variables in the analysis are consistent with theory and past results. We see that years of education and experience each have a positive return (at a diminishing rate). The household head variable is positive which supports past literature. The race variables follow past results for the LN(Wage) regression, but most change value and some change sign when wage is augmented by the cost of living index. Interestingly, all of the race variables change significance sign except for the American Indian designation. After controlling for cost of living, earnings for “black” Americans’ were not statistically different from earnings for “white” Americans. Also after this adjustment, “Asian” Americans earned a statistically significant amount less than “White” Americans, equal to almost ten years of education.

The next three variables of married, female and English each show the expected result. For example, those reporting to be married earned a statistically significant amount more than those who responded as single. This difference is roughly equivalent to three years of education. Females earned less than males, about equal to two years of education. For those who did not speak English fluently, their wage went down but by a much smaller amount than the previous two. However, when adjusting wage for cost of living the English variable grew tremendously. This might show that speaking English in low income areas is considered an advantage, probably where most of the non-English speakers reside.

**Keywords:** superfund sites, hedonic wage, differential-wage equation, non-market valuation

## References

- Gayer, T., Hamilton, J. T., & Viscusi, W. K. (2000). Private values of risk tradeoffs at superfund sites: Housing market evidence on learning about risk. *Review of Economics and Statistics*, 82(3), 439-451.
- Greenstone, M., & Gallagher, J. (2008). Does hazardous waste matter? Evidence from the housing market and the superfund program. *Quarterly Journal of Economics*, 123(3), 951-1003.
- Hamilton, J. T., & Viscusi, W. K. (1999). How costly is "Clean"? An analysis of the benefits and costs of superfund site remediations. *Journal of Policy Analysis and Management*, 18(1), 2-27.
- Noonan, D. S., Krupka, D. J., & Baden, B. M. (2007). Neighborhood dynamics and price effects of Superfund site clean-up. *Journal of Regional Science*, 47(4), 665-692.
- Noonan, D. S., Turaga, R. M. R., & Baden, B. M. (2009). Superfund, Hedonics, and the Scales of Environmental Justice. *Environmental Management*, 44(5), 909-920. doi:DOI 10.1007/s00267-009-9372-y
- Walker, D. R. (1992). A method for estimating the local area economic damages of Superfund waste sites. (PhD), Michigan State University, Ann Arbor.
- Zuindeau, B., & Letombe, G. (2008). Hazardous waste sites and property values: a French case study in the light of US analyses. *International Journal of Environment and Pollution*, 32(3), 387-409. A. A., Author, B. B., & Author, C. C. (Year). Title of article. Title of Journal, volume number (issue number), pages.
- Cobanoglu, C., & Cobanoglu, N. (2003). The effect of incentives in web surveys: application and ethical considerations. *International Journal of Market Research*, 45(4), 475-488.

# The Impact of Bankruptcy Law on Entrepreneurship (Self-Employment)

Sylwia Morawska<sup>1</sup>, Joanna Kuczevska<sup>2</sup>, and Błażej Prusak<sup>3</sup>

<sup>1</sup>Collegium of Business Administration,  
Warsaw School of Economics, Warsaw, Poland

<sup>2</sup>Faculty of Economics,  
University of Gdańsk, Gdańsk, Poland

<sup>3</sup>Faculty of Management and Economics,  
Gdańsk University of Technology, Gdańsk, Poland

## Abstract

The scientific aim of the analysis is to fill the research gap concerning empirical studies on the impact of bankruptcy law on entrepreneurship (self-employment) through lowering entrance and exit barriers. By analyzing different economic and institutional factors influencing the level of entrepreneurship, our study helps to develop research methods allowing to demonstrate, that bankruptcy law has both statistical and economic effects on self-employment level.

Research will fill the cognitive gap related to the impact of the bankruptcy system model on the development of entrepreneurship. Furthermore, the impact of “severity level” of bankruptcy proceedings on propensity to engage in business activities will be empirically tested – in order to verify the main thesis of the study, that a more liberal (less strict) bankruptcy law (debtor-friendliness of the bankruptcy law model) favors entrepreneurship and self-employment.

A comprehensive regulatory framework governing the issues of insolvent entrepreneurs has a pivotal role in the functioning of bankruptcy institution. The quality of the law and its efficiency is crucial when it comes to adopting insolvency practices in the economy. Properly set targets in the insolvency procedure, responsive to the needs of the economy, can facilitate business activities, guaranteeing an immediate return of production means in case of underperformance on one hand, and favoring actions aimed at debt restructuring or corporate restructuring on the other. The effectiveness of law is a research area closely linked to American legal realism, whereas in many countries (e.g. Poland) the effectiveness of law is still not a subject of an in-depth reflection, detailed analysis or cross-disciplinary research. An efficient legal system must work under specific social and economic conditions. Law remains a dead letter if it is not properly applied. Thus, representatives of American legal realism draw a distinction between “law in books” and “law in action” (Dworkin, 1998). The lack of efficiency of legal institutions causes the legislation to lose importance. The need for cross-disciplinary research is mainly due to the need for entrepreneurship. Empirical studies on institutions in the economy blend with the institutional economics and are crucial when it comes to emphasize the importance of institutional and political factors for the economic growth (Coase 1937, Demsetz 1997, Godłów-Legiędź 2005, Hodgson 2004, North 1990, Ostrom 1990, Ratajczak 1994, Rudolf 2005, Stankiewicz 2012, Williamson 1998, Ząbkowicz 2003).

In order to verify the impact of bankruptcy law characteristics on self-employment, we will employ quantitative and qualitative methods. During the first stage, a review of existing world literature shall be conducted, enabling us to specify economic and institutional factors having impact on boosting entrepreneurship. Moreover, a qualitative study on bankruptcy proceedings (based on

Poland case) from 2004 to 2016 shall also be conducted, allowing us to analyze their characteristics and estimate the amount of small and microbusinesses making use of bankruptcy proceedings.

In order to verify the research hypotheses, we will use quantitative methods: the cross-sectional ANOVA test and regression method. The following variables shall be standardized: ease of second chance, severity of bankruptcy procedures index and resolving insolvency index. In the next step, on the basis of their standardized values, factorization in pairs (e.g. debtor-friendliness of bankruptcy law versus its efficiency) will be performed according to the mean. Finally, two studies will be conducted using the classic analysis of variance.

**Keywords:** bankruptcy law, entrepreneurship (self-employment)

## References

- Aguiar-Díaz Inmaculada, María Victoria Ruiz Mallorquí (2015). Bank debt versus trade debt and time of bankruptcy resolution, *Investigaciones Europeas de Dirección y Economía de la Empresa*, Volume 21, Issue 3, September–December 2015, Pages 111–119
- Aguiar-Díaz Inmaculada, María Victoria Ruiz-Mallorquí (2015). Causes and resolution of bankruptcy: The efficiency of the law, *The Spanish Review of Financial Economics*, Volume 13, Issue 2, July–December 2015, Pages 71–80
- Araujo Aloisio P., Rafael V.X. Ferreira, Bruno Funchal (2012). The Brazilian bankruptcy law experience, *Journal of Corporate Finance*, Volume 18, Issue 4, September 2012, Pages 994–1004
- Araujo Aloisio, Bruno Funchal (2005). Past and Future of the Bankruptcy Law in Brazil and Latin America, *Economía Journal of the Latin American and Caribbean Economic Association*, Volume 6 Number 1 (2005).
- Armour John, Douglas Cumming (2008). Bankruptcy Law and Entrepreneurship, ECGI - Law Working Paper No. 105/2008
- Athreya Kartik B. (2003). Fresh start or head start? uniform bankruptcy exemptions and welfare, Federal Reserve Bank of Richmond Working Paper, May 2003, No. 03-3R
- Ayotte Kenneth (2007). Bankruptcy and Entrepreneurship: The Value of a Fresh Start, *Journal of Law Economics & Organization*, 04/2007; 23(1):161-185
- Ayotte Kenneth, Hayong Yun (2009). Matching bankruptcy laws to legal environment, *JLEO: Journal of Law, Economics & Organization* (2009). 25 (1): 2-30.
- Baird Douglas G. (2005). Serial Entrepreneurs and Small Business Bankruptcies, 105 *Columbia Law Review* 2310
- Baird Douglas G., Bob Rasmussen (2002). The End of Bankruptcy, *U Chicago Law & Economics*, Olin Working Paper No. 173; *Vanderbilt Law and Economics Research Paper* No. 02-23
- Bariatti Stefania, Robert van Galen (2014). Study on a new approach to business failure and insolvency – Comparative legal analysis of the Member States’ relevant provisions and practices, European Union, TENDER No. JUST/2012/JCIV/CT/0194/A4
- Bebchuk Lucian Arye (2000). Using options to divide value in corporate bankruptcy, *European Economic Review*, Volume 44, Issues 4–6, May 2000, Pages 829–843
- Bebchuk Lucian Arye (2002). Ex Ante Costs of Violating Absolute Priority in Bankruptcy, *The Journal of Finance*, Vol. 57, No. 1 (Feb., 2002). pp. 445-460
- Bisogno Marco, Roberto De Luca (2014). Bankruptcy Efficiency and Indirect Costs in Italian SMEs: a temporal approach, *International Journal of Business Research and Development*, vol. 3, no. 2, 2014
- Broggi Ricardo, Santella Paolo (2004). Two New Measures of Bankruptcy Efficiency, *SUERF – The European Money and Finance Forum*, Vienna 2004
- Busenitz Lowell W., Carolina Gómez, Jennifer W. Spencer (2000). Country institutional profiles: unlocking entrepreneurial phenomena, *The Academy of Management Journal*, Vol. 43, No. 5 (Oct., 2000). pp. 994-1003
- Camacho-Miñano María-del-Mar (2013). Bankruptcy Law Ex-ante Efficiency: Empirical Evidence in Spain, *International Insolvency Review*, Volume 22, Issue 3, pages 171–187, Winter 2013



- Camacho-Miñano María-del-Mar, Pascual-Ezama David, Urquía-Grande Elena (2013). On the Efficiency of Bankruptcy Law: Empirical Evidence in Spain, *International Insolvency Review*, Volume 22, Issue 3, pages 171–187, Winter 2013
- Claessens Stijn, Leora F. Klapper (2002). Bankruptcy around the World: Explanations of its Relative Use, *American Law and Economics Review*, (Spring 2005). 7 (1): 253-283.
- Coase R. H. (1937). The Nature of the Firm, "Economica", 1937, nr 4, s. 390
- Cornelli Francesca, Leonardo Felli (1997). Ex-ante Efficiency of Bankruptcy Procedures, *European Economic Review* 41 (1997). pp.475-485
- Demsetz (1997). The Firm in Economic Theory: A Quiet Revolution, *The American Economic Review*
- Dworkin (1998). Biorąc prawa poważnie ( Taking Rights Seriously). Warszawa
- Fisher Timothy C.G., Jocelyn Martel (2005). The Firm's Reorganization Decision: Empirical Evidence from Canada, *Journal of Empirical Legal Studies*, Vol. 2, No. 1, (March 2005). pp. 151-169
- Godłów-Legiędź J. (2005). Transformacja ustrojowa z perspektywy nowej ekonomii instytucjonalnej, 2005, nr 2
- Hautcoeur Pierre-Cyrille, Paolo Di Martino (2011). Bankruptcy Law and Practice in Historical Perspective: A European Comparative View (C. 1880-1913).
- Hodgson (2004). The Evolution of Institutional Economics: Agency, Structure and Darwinism in American Institutionalism, Routledge, London
- Hummelen Jochem M. (2014). Efficient Bankruptcy Law in the u.s. and the Netherlands Establishing an Assessment Framework, *European Journal of Comparative Law and Governance*. 1, 2, p. 148-211 63 p.
- Jia Ye (George). (2015). The Impact of Personal Bankruptcy Law on Entrepreneurship, *Canadian Journal of Economics/Revue canadienne d'économie*, Vol. 48, Issue 2, pp. 464-493
- Kuczevska Joanna (2014). Polityka Unii Europejskiej i Polski wobec małych i średnich przedsiębiorstw – kierunki i wyzwania, w: 10 lat członkostwa Polski w Unii Europejskiej. Ocena i perspektywy., red. Latoszek E., Stępiak A., Kłos A., Krzemiński M., Gdańsk
- Kuczevska Joanna, Stefaniak-Kopoboru Joanna (2016). The new strategy of the European union's internal market, *Analizy i Opracowania KEIE UG nr 2/2016*
- Lee Seung-Hyun, Mike W. Peng and Jay B. Barney (2007). Bankruptcy Law and Entrepreneurship Development: A Real Options Perspective, *Academy of Management Review*, January 1, 2007 vol. 32 no. 1 257-272
- Lee Seung-Hyun, Yasuhiro Yamakawa, Mike W. Peng, Jay B. Barney (2011). How do bankruptcy laws affect entrepreneurship development around the world?, *Journal of Business Venturing*, Volume 26, Issue 5, September 2011, Pages 505–520
- Morawska S. (red.). (2011). *Ekonomia i prawo upadłości przedsiębiorstw. Zarządzanie przedsiębiorstwem w kryzysie*, Warszawa 2011
- North (1990). *Institutions, Institutional Change and Economic Performance*, Cambridge University Press, Cambridge
- Ostrom (1990). *Governing the Commons: The Evolution of Institutions for Collective Action*. Cambridge: Cambridge University Press
- Peng Mike W., Yasuhiro Yamakawa, Seung-Hyun Lee (2009). Bankruptcy Laws and Entrepreneur-Friendliness, *Entrepreneurship Theory and Practice*, 34 (3). 517–530
- Primo David M., Wm Scott Green (2011). Bankruptcy Law and Entrepreneurship, *Entrepreneurship Research Journal*, Volume 1, Issue 2 2011
- Prusak Błażej (red.). (2012). *Przedsiębiorstwo w czasach kryzysu*, Politechnika Gdańska, Gdańsk 2012
- Rudolf (2005). *Nowa ekonomia instytucjonalna. Teoria i zastosowania praktyczne*, Wyższa Szkoła Ekonomii i Prawa w Kielcach
- Stankiewicz W. (2012). *Ekonomika instytucjonalna. Zarys wykładu*, Wydawnictwo Prywatnej Wyższej Szkoły Businessu, Administracji i Technik Komputerowych, Warszawa
- Williamson O.E. (1998). *Ekonomiczne instytucje kapitalizmu. Firmy, rynki, relacje kontraktowe*, PWN, Warszawa
- Ząbkowicz A. (2003). *Współczesna ekonomia instytucjonalna wobec głównego nurtu ekonomii*, *Ekonomista* Nr 6

## *Education & Training*

# Hospitality Education Program Student Operated Restaurants: A Practical Education Component

Angad Singh Dang and Patrick Moreo

The College of Hospitality and Tourism Leadership  
University of South Florida Sarasota-Manatee, United States

## Abstract

Hospitality Education colleagues have observed over the years that hospitality students need to understand theory but that they must also understand how to apply that theory in situ. Dean Howard Meek of the Cornell University School of Hotel Administration observed many years ago that our students appear to do well when they first see an example or application of a principle, theory or model. After having been exposed to that example they then are ready to understand the theory and principles involved in the example. Lastly, having understood the theory, they are ready to reapply that theory or model in many other settings, applications and examples.

Experiential learning may be key to the overall success of students in the workplace. In order for students to have a holistic experience, they should be exposed to hands-on learning. There are over 30 accredited colleges in the United States with strong hospitality programs. Many of these colleges offer a chance for students to work in student run restaurants (SRR). This allows the students to experience real hospitality management and be prepared for the industry upon graduation.

## *Purpose of Study*

The purpose of this study is to ascertain the role and potential role of student run commercial food operation in hospitality education programs?

## *Research Questions*

- What are the learning outcomes that students experience in the SRR?
- What do the directors of the hospitality programs view as crucial components of SRR's to make them beneficial for experiential learning, as well as keeping the SRR's cost effective?
- How do the restaurants fit in the curriculum?
- What is the extent of Student involvement in the SRR's?
- What is the extent of faculty involvement in the SRR's?

## Methodology

An in-depth, semi structured interview questionnaire was created. The research conducted needed to answer the research questions as listed above and repeated here. The purpose of our current study was to ascertain the role and potential role of student run commercial food operations in hospitality education programs?

In particular, the researchers wanted to have a fuller understanding of the impact a Student Run restaurant (SRR) can have on an individual who is about to enter the restaurant business. Does a

SRR provide a setting where a student could get some experiential learning in a controlled environment?

The seven participants in the study were all either teaching the Restaurant Operation course or were Directors of the respective hospitality programs in which the SRR was housed. The method of gathering data was through in-depth interviews, which were conducted on the telephone. These interviews were then summarized in a transcription. by the principal researcher. Once the interviews were transcribed, they were categorized in an Excel spread sheet. All the questions had a relative answer in the rows with names of participants in the corresponding columns. Once all the questions and condensed responses were entered into the table, a content analysis was carried out. The themes were underlined and in the end a pattern was formed.

**Keywords:** experiential learning, student run restaurant, front of the house, back of the house

## References

- Blyth, A., & Menagh, L. (2006). From rooftop to restaurant. A university cafe fed by a rooftop garden, 5054.
- Breiter, D., Cargill, C., & Fried-Kline, S. (1995). An industry view of experiential learning. *Hospitality Review*, 13(1), 8.
- Farmer, T. (2015). Serving Others: Student-Run Restaurant Teaches Many Lessons. *Journal of Family and Consumer Sciences*, 107(3), 55.
- Hamer, L. O. (2000). The additive effects of semi structured classroom activities on student learning: An application of classroom-based experiential learning techniques. *Journal of Marketing Education*, 22(1), 25-34.
- Jeou-Shyan, H., & Lu, H. Y. (2006). Needs assessment of professional competencies of F&B/hospitality management students at college and university level. *Journal of Teaching in Travel & Tourism*, 6(3), 1-26.
- Josiam, B. M., Malave, R., Foster, C., & Baldwin, W. (2014). Assessing quality of food, service and customer experience at a restaurant: the case of a student run restaurant in the USA. *Journal of Services Research*, 14(1), 49.
- Kiser, J. W., & Partlow, C. G. (1999). Experiential learning in hospitality education: An exploratory study. *Journal of Hospitality & Tourism Education*, 11(2-3), 70-74.
- Maier, T. A., & Thomas, N. J. (2013). Hospitality leadership course design and delivery: A blended-experiential learning model. *Journal of Hospitality & Tourism Education*, 25(1), 11-21.
- Nies, J. I. (1993). The role of student-operated restaurants in the hospitality curriculum. *Hospitality & Tourism Educator*, 5(3), 21-24.
- Parker III, E. T., Kilgo, C. A., Sheets, J. K. E., & Pascarella, E. T. (2016). The Differential Effects of Internship Participation on End-of-Fourth-Year GPA by Demographic and Institutional Characteristics. *Journal of College Student Development*, 57(1), 104-10
- Pettillose, M. J., & Montgomery, R. (1997). An exploratory study of internship practices in hospitality education and industry's perception of the importance of internships in hospitality curriculum. *Journal of Hospitality & Tourism Education*, 9(4), 46-51.
- Richardson, J. D., & Kleiner, B. H. (1992). The relevant effectiveness of different training and development methodologies. *Management Research News*, 15(10), 23-25
- Ruhanen, L. (2006). Bridging the divide between theory and practice: Experiential learning approaches for tourism and hospitality management education. *Journal of Teaching in Travel & Tourism*, 5(4), 33-51.
- Taylor, M. S. (1988). Effects of college internships on individual participants. *Journal of Applied Psychology*, 73(3), 393.
- West, M. B., & Farley, G. A. (1991). A cost-effective quantity food lab through the use of shared resources. *Hospitality & Tourism Educator*, 4(1), 15-20.

# Keeping Hospitality, Travel, and Tourism Students on the Pathway: A Guided Learning Journey to Success With ePortfolio

Leslie G. Scamacca and James Giordano

LaGuardia Community College  
The City University of New York, United States

## Abstract

This presentation shares progress of Travel, Tourism, and Hospitality faculty at an urban community college in their undertaking of curriculum review following a guided pathways approach. This two-year project is funded through the college's Center for *Teaching and Learning* and focuses on several key objectives, such as making connections between the various courses throughout the curriculum; helping students make connections between their diverse experiences; and facilitating integrative learning and reflection activities for students. These connections are leveraged through the development of a core student ePortfolio.

This project is guided by four pedagogical practice areas from the American Association of Community Colleges (AACC). These main practice areas informed specific phases of this project and include:

- Mapping pathways to student end goals
- Helping students choose and enter a program pathway
- Keeping students on a path
- Ensuring that students are learning

### *Mapping Pathways to Student End Goals*

The College has developed a framework for advanced student learning. The framework's core competencies (Inquiry and Problem Solving, Global Learning, and Integrative Learning) and communication abilities (Oral, Written, and Digital) are designed to help ensure that all graduates develop their capacity to build and use knowledge with the higher order thinking processes essential to success in advanced education and career. The competencies and abilities articulate key benchmark goals for general education and programmatic learning, structure assessment in both areas, and reflect the College's collective vision for student learning.

The initial phase of this project included faculty defined and led identification of essential curricular learning outcomes. The learning outcomes aligned with the overall college core competencies and abilities.

### *Helping Students Choose and Enter a Program Pathway*

The second phase of this project focused on preparing students for the economy, for democracy and global community, and to pursue their own hopes for a better future. Helping students choose and enter a program pathway begins in a well-designed and intention First Year Seminar experience. In this course, students are introduced to many pathways to success, including classroom learning, advisement, co-curriculars, and internship opportunities. The First Year Seminar enables a constant focus on the most important purposes of college learning.

### *Keeping Students on a Path*

The third phase of this project helps keep students on a path to graduation and success. Programs, courses, and assignments are well-designed and sequenced to foster deep learning. This is achieved through mapping essential learning outcomes across the entire program at progressively more challenging levels from initial courses to final studies. Deep learning is also achieved through connecting the curriculum visibly with the wider world and students' own questions, while providing clarity, direction, and progress points or "markers" for students.

With equity a paramount value, programs meld high-touch and high tech to monitor and support student progress giving special attention to frequent or systemic barriers and challenges. Here, we build an intentional and welcoming community, so that every student feels known, respected, supported, and savvy about where to find help. The "High Touch" component includes mentoring and individualized degree plans to connect program pathways (and developmental education, if needed) with students' own goals, lives, and emerging interests, while the "High Tech" component deploys data analytics to provide timely information about student progress and problems, and to address systemic disparities or barriers.

### *Ensuring That Students Are Learning*

The final project phase has all students participating frequently in high impact practices, from first to final year. Here, the focus shifts the focus from passive listening to students' own effortful engagement with questions, problems, and projects including community, or work-based projects. The guided pathways approach also ensures students' continuing practices of essential learning outcomes such as inquiry, analysis, engagement with difference, collaborative problem-solving, ethical inquiry, quantitative and scientific reasoning, information literacy, and communication skills.

Every student completes an applied learning project which is connected to program and student goals. The goals include connecting college learning with unscripted questions important to the student; preparing and enabling students to become self-directed learners; and embracing AAC&U's LEAP challenge. The LEAP challenge invites higher education instructors to make students' "signature work" a catalyst for their integrative and applied learning.

Students' own work, including their applied learning projects, provides the primary evidence of their progress toward degree level learning and educational achievement. Reducing the emphasis on assessment that are disconnected by design from the actual program of study; shifting our focus to students' own "best work".

### **References**

- Ambrose, S. A., Bridges, M. W., DiPietro, M., Lovett, M. C., & Norman, M. K. (2010). *How learning works: 7 research-based principles for smart teaching*. San Francisco, CA: Jossey-Bass.
- Bailey, T., Smith-Jagers, S. & Jenkins, D. (2015). *Redesigning America's Community Colleges: A clearer path to student success*. Cambridge, MA: Harvard University Press.
- Castleman, B. L., & Page, L. C. (2014). *Freshman year financial aid nudges: An experiment to increase FAFSA renewal and college persistence* (EdPolicy Works Working Paper No. 29) Charlottesville, VA: University of Virginia, Center on Education Policy and Workforce Competitiveness.

- City University of New York, Office of Institutional Research and Assessment (2014). System retention and graduation rates of full-time first-time freshmen in associate programs by year of entry: Queensborough, 2014. New York, NY.
- Collins, J., & Porras, J. I. (1994). *Built to last: Successful habits of visionary companies*. New York, NY: HarperCollins.
- Grant, H., & Dweck, C. S. (2003). Clarifying achievement goals and their impact. *Journal of Personality and Social Psychology*, 85(3), 541–553.
- Jenkins, D. (2011). *Redesigning community colleges for completion: Lessons from research on high-performance organizations* (CCRC Working Paper No. 24). New York, NY: CCRC.
- Jenkins, D., Lahr, H., & Fink, J. (2017). *Implementing guided pathways: Early insights from the AACC Pathways Colleges*. New York: Community College Research Center, Teachers College, Columbia University.
- Jenkins, D., & Cho, S. W. (2012). *Get with the program: Accelerating community college students' entry into and completion of programs of study* (CCRC Working Paper No. 32). New York, NY: CCRC.
- Jenkins, D., & Weiss, M. J. (2011). *Charting pathways to completion for low-income community college students* (CCRC Working Paper No. 34). New York, NY: CCRC.
- Keller, P. A., Harlam, B., Loewenstein, G., & Volpp, K. G. (2011). Enhanced active choice: A new method to motivate behavior change. *Journal of Consumer Psychology*, 21(4), 376–383.
- Kezar, A. (2011). What is the best way to achieve broader reach of improved practices in higher education? *Innovative Higher Education*, 36(4), 235–247.
- Thaler, R. H., & Sunstein, C. R. (2008). *Nudge: Improving decisions about health, wealth, and happiness*. New Haven, CT: Yale University Press.

# Who Wants Business and Economics Diploma via Open Education: Example of Anadolu University, Turkey

Hasan Durucasu<sup>1</sup> and Fikret Er<sup>2</sup>

<sup>1</sup>Faculty of Economics and Administrative Sciences  
Anadolu University, Turkey  
<sup>2</sup>Open Education Faculty  
Anadolu University, Turkey

## Abstract

Obtaining a university diploma is a very hard work. One should study hard, attend classes, strictly follow the deadlines for home works etc. What if you do not have time and money to attend to in-campus education for a university diploma. This is the case for many people, there are situations where an individual cannot attend to formal education for a university diploma whatever the reason. The simple solution to this problem is Open Education. Open Education has been used in Turkey since 1982 via Anadolu University. Anadolu University has provided students a chance to get a diploma and more than two million students have already graduated. When Anadolu University Open Education system was founded in 1982, the main learning material, the course book, was sent to the students by regular in surface post. Students were given exam dates, one midterm and one final exam. They were invited to the exam centres and multiple-choice exams were filled out. After completing successfully one term, students were allowed to continue with the remaining terms. Anyone who has somehow get in touch with a Business and Economics degree will easily see that there are some core courses that will make a headache, such as mathematics and statistics. To study these subjects at home by yourself is very difficult indeed. In order to solve this problem, Anadolu University created an educational TV group called ETV. They were responsible to create TV programs for students as if they were in a classroom and listening their courses from a lecturer. Turkish Radio and Television Corporation, later, dedicated an educational channel called TRT 4 so that these educational programs were aired and reached many students around Turkey. In 1982, there were not many universities for students to attend and also to enrolled in to one of the universities available was very tough. Therefore, again open education provided the opportunity of getting a university education for those in need. The open education system also allowed the have improvement on gender equality in higher education in Turkey. In a recent study by Aktaş and et al. specifically aimed at to assess how gender ratio has evolved over 32 years, whether spatial clustering exists within the gender data around the country, and to what extent women were represented in higher education programs. Turkey is not a small country, geographically speaking. To answer these queries, gender ratio datasets were examined using visual (mapping) and spatial cluster analyses. Findings support that, distant programs of the university have helped more women participate in higher education programs across the country over the years, leading to relatively more normalized distribution of gender in education across the geographical regions. It has already been said that in order for students to be successful support TV programs were created. In later years, Anadolu University started to make agreements with local universities for teaching of difficult subjects such as statistics and mathematics to open education students leaving in those cities. A lecturer from participating university started teaching the course with the material provided by Anadolu University, course book, in-class to those students who want to attend. The course time tables were scheduled either late at night such as between 19:00 and 22:00 hours or on the weekends using the facilities of these universities. This



structure of teaching gave a new dimension to Open Education in Turkey. If you are comfortable with the course material given to you and were able to understand the subject and take the exam you had no problem. But If you can not a difficult subject you were given a chance of listening the course from television or from a lecturer (for limited number of courses). In this study, the general structure of students attended the Business and Economics programs of Anadolu University are studied. A general picture of this student body is investigated. The main characteristics of the students are given by tables and maps (via spatial data analysis methods). The lessons learned from past and passed down to the future are given.

**Keywords:** open education, business and economics education, learning

## **References**

- Aktas, S.G., Kumtepe, E.G., Kantar, Y.M., Ulukan, İ.C., Aydın, S., Aksoy, T. and Er, F. “Improving Gender Equality in Higher Education in Turkey” *Appl. Spatial Analysis* (2017). <https://doi.org/10.1007/s12061-017-9235-5>
- Talbot C. (2010) “Studying at a distance” Open University Press, The McGraw-Hill.
- Weller M. (2014) “The battle for open How Openness won and why it doesn’t feel like victory” Ubiquity press, London

# **Innovation of Online Training Program With the Implementation of High-Impact Integrative Learning Structure for the Hospitality Faculty**

Murat Kizildag<sup>1</sup>, Nan Hua<sup>1</sup>, Ahmet Bulent Ozturk<sup>1</sup>, Baiyun Chen<sup>2</sup>, and Beth Nettles<sup>2</sup>

<sup>1</sup>Rosen College of Hospitality Management  
University of Central Florida, USA  
<sup>2</sup>Center for Distributed Learning  
University of Central Florida, USA

## **Abstract**

The crux of this paper touches upon a main overarching theme that enhances undergraduate student learning outcomes by implementing high-impact integrative learning and teaching strategies. This paper specifically aims to create a course development training program online with a focus on discipline-specific integrative learning strategies and experiences for hospitality courses. The integrative learning tactics and immersive learning strategies are defined as; (1) co-curricular, (2) curricular, and (3) career development. The proposed integrative learning initiatives are committed to build knowledge about the depth of student learning that results from participation in integrative opportunities. Therefore, based on those learning tactics and strategies, this paper will provide greater understanding of the broad usages of online courses designed with high-impact integrative learning experiences and establish a concerted focus on student learning and growth in hospitality courses.

**Keywords:** online training program, online course development, high-impact learning structure, integrative learning

## **Introduction**

As hospitality management is considered in the field of applied science, creating and enhancing a learning environment, where students apply their existing discipline-specific knowledge to the real life applications of contemporary business, world is critical and necessary. Traditional course structure does not often support integrative learning experiences to some of the discipline-specific courses such as, hospitality courses. As hospitality education shifts from traditional education to online education, the online course development and training programs become very important because these programs provide faculty a well-structured and carefully guided experience, which also help them develop relevant online classes for more effective and integrative teaching platform and approaches.

Online classes are used as a critical tool and medium for all faculty members who teach hospitality courses to further improve their teaching effectiveness and ultimately benefit undergraduate students' learning outcomes. The featured structured flexibility of the online classes will give students great opportunities to apply the theoretical skills and knowledge to the real business world. In addition, these platforms help hospitality students improve their managerial decision making abilities that would lead to optimal operation and management results. Therefore, developing a training program to facilitate faculty and student learning in this new domain is an urgent task, particularly given the mounting pressure of physical and time constraints for undergraduate students as well as increasing pressure on the workload for faculty resulted from explosive growth in student population in hospitality schools and colleges.

While many studies have investigated about the effectiveness of online courses at the individual course level, very few studies provide guidance for quantitative courses (i.e., hospitality financial management) taught in hospitality colleges and schools. Therefore, within the particular context of hospitality management, the ultimate objectives of this paper are multifold. This paper mainly focuses on student learning development with high-impact learning stakes. It also aims to: (a) create effective online classroom teaching with interactive learning experiences, (b) advance curricular student learning and learning outcomes assessment, (c) connect discipline-specific knowledge to real-life practices with interactive and integrative high-impact learning practices, such as interactive excel solutions for the class projects and assignments

## **Literature Review**

The adoption of blended learning with online environments (i.e., online learning portals, course systems, etc.), the combination of traditional face-to-face and technology-mediated instruction, is increasing in higher education around the world. In fact, scholars have predicted that this learning structure will become the “new model and or new norms in education” in higher education course delivery (Ross and Gage, 2006; Norberg, et al., 2011. The special feature of structured flexibility of online classes offer great integrative learning opportunities for students in the hospitality colleges, schools, and programs. This is because they possess a greater opportunity to benefit from, “prior professional, academic, and life experiences inside and outside the classroom” exemplifying the cohesive and holistic idea of applying what they learned from these classes to the complex and real business world of hospitality (AACU, 2016).

## **Methodology**

Student learning outcomes will be assessed by a pre- and post-test methodology. Two assumptions are made: First, the faculty participant of the integrating learning online training program completes the training by the end of the fall semester in 2017; and second, the faculty will implement integrative learning strategies from the online training program to the class(es) he or she is teaching in the Spring of 2018.

In specific, the design follows a two-semester time window. To start, a survey will be designed to assess students’ perception of faculty teaching and student learning in the fall semester of 2017. This is before the implementation of integrative learning strategies. The same survey will be sent to students again in the spring semester of 2018 after the faculty implements in his or her teaching integrative learning strategies to the same classes, which are attained from the online training programs.

## **Expected Outcomes, Implications, Future Directions**

This paper intends to put forth significant experience in fostering integrative learning through changes in curricula, pedagogy, student assessment, and student learning tactics for current and future research. Because of the advantage of structured flexibility, hospitality students will also find these classes more compatible with their busy academic and professional life. Thus, this paper will put forth high-impact integrative learning materials in place to facilitate faculty teaching and to improve student learning in the hospitality schools and colleges. As a result, faculty members will be able reach a broader student population that would not have been otherwise possible.

Interacting with students from different parts of the country or the world will not only enhance the students' learning experience but also the instructors' efficiency. The implications of this paper discuss the featured structured flexibility of the online classes, which provide students great opportunities to apply the skills and knowledge to the real world applications.

## References

- AACU. (2002). 2016 Annual Meeting: *How Higher Education Can Lead—On Equity, Inclusive Excellence, and Democratic Renewal*. Retrieved from <https://www.aacu.org/meetings/annualmeeting/am16>
- Norberg, A., Dziuban, C. D., & Moskal, P. D. (2011). A time-based blended learning model. *On the Horizon*, 19(3), 207-216.
- Ross, B., & Gage, K. (2006). Global perspectives on blending learning. *Bonk J. C. Graham R. C. (Eds.). The handbook of blended learning*, 155-168.

# *Finance & Banking*

# To What Extent Does Franchise Decision Affects Restaurant Firm's Financial Performance?

Ayşegül Acar<sup>1</sup> and Mehmet Erkan<sup>2</sup>

<sup>1</sup>Safranbolu Tourism Faculty  
Karabük University, Turkey

<sup>2</sup>Faculty of Economics  
Istanbul University, Turkey

## Abstract

Franchising is considered as significant sources of entrepreneurial activity both in the United States and abroad. Franchising, especially in the US, grew so fast since the 1950s that it is now convincing in the US economy. Many companies in various sectors have adopted franchising as a way of doing business. Franchising, now, prevails in certain sectors of the US economy. It is a fact that the change in lifestyles in the USA and Western Europe is two important environmental factors contributing to the development of franchising, with an increasing emphasis on service and convenience and higher travel intensity that increase the value of a brand. Not surprisingly, the franchise also catches a large part of the restaurant industry and plays an important role in its success. In a survey conducted by the International Franchise Association (IFA), franchising is reported to have expanded by about twice the rate of company-owned ventures (Bradach, 1998). Consumer mobility and time constraints have increased the popularity of the restaurant chain. In order to avoid losing time searching for a restaurant in unfamiliar locations, it is likely for consumers to choose restaurants having national brand name over local restaurants (Matheson and Winter, 1985; Sen, 1998). As a result, many restaurants have chosen franchising as the preferred growth method. Franchising has been seen as a major source of entrepreneurial activity around the world (Combs et al., 2004). As defined simply by Kostecka (1987): "A franchise is a way of doing business where a franchisee has the right to offer, sell or distribute goods or services under a marketing form designed by the franchisor. The franchisee allows the franchisee to use the franchisee's trademark, name and advertising. A franchise is a form of organization through which a firm (franchisor) permits a second (franchisee) to use its business practices and to market goods or services under the brand name of the franchisor. The franchise has developed over time, depending on the relationship between the franchisor and the franchisee. The franchise system can be operated in two formats. One of these is franchising of product or trade name distribution. This is a more limited business relationship between the supplier and the dealer; In this way, the franchisor gives the franchisee the right to use the trademark of the franchisee, but might not provide a system to help the franchisee manage the business. Automobile dealership and gasoline are samples of that. Second is the business format franchising. It consists of an ongoing commercial relationship between a firm with a proven business system (franchisor) and a third party (franchisee). Many franchise research focuses on business format franchises that sell the franchisor's trade name, operating systems, product specifications, and the full use of the business concept. Examples of business format franchises are fast service restaurants and accommodation chains. The rapid growth of franchising has caught the attention of researchers from various academic fields (Elango and Fried, 1997). Over the last 20 years, a significant amount of franchising research has been conducted in a variety of disciplines, including economics, law, marketing and management. Many franchising studies have focused on motivation for franchising (Anderson, 1984; Allon, 2001; Carney and Gedajlovic, 1991; Combs and Ketchen, 1999; Shane,

1998). However, few studies have elucidated the relationship between the franchising and the firm's financial performance (Shane, 1996; Michael, 2002; Combs et al., 2004; Srinivasan, 2006; Hsu and Jang, 2008). The scarcity theory of resources and the agency theory are two dominant theories that explain the motivation of firms for franchising decisions (Aliouche and Schlentrih, 2005). The scarcity theory tends to see franchising as a means to gain access to scarce resources as a firm grows. It explains it in the following way: Franchising allows their franchisor companies to use franchisees' capital and management expertise to accelerate growth to reach minimum efficient scale and public brand capital (Hunt, 1973; Norton, 1998). On the other hand, the agency theory focuses on the efficiency of the incentive features of the franchise relationship (Crney and Geadjlovic, 1991; Combs and Ketchen; 1999, Norton, 1988). According to the agency theory, the advantage of franchising is that it encourages franchises to maximize the profits of franchising, turning outlet managers into owners, and reducing the need for direct monitoring by the franchisor. The behaviour of the company's unit manager will require more monitoring than the behaviour of the franchised-owned outlet manager. Three important franchising research topics need to be studied in order to understand the franchise phenomenon: the franchise initiation, then the subsequent tendency to franchise and franchise performance (Combs et al., 2004). Comprehensive research has been conducted on whether franchising increases the access to scarce resources or reduces the costs of monitoring, and if this elucidates tendency to franchise (Alon, 2001; Brickley and Dark, 1987; Combs, Michael and Castrogiovanni, 2004; Sen, 1998). Less attention was given to why companies start franchising and how franchising affects financial performance. Combs et al. (2004) suggested changing the research emphasis on these two issues in order to guide the entrepreneur whether to franchise an existing business and to understand how the franchising affects the performance of a firm's performance. In response to this need, this study applied agency theory and the scarcity theory and used both franchised and non-franchised companies' data to investigate the factors that could affect the decision.

### *Purpose of the Study*

Considering the success and popularity of franchising, it seems that franchising has helped companies to achieve superior financial performance compared to non-franchised businesses. The purpose of this study is to empirically investigate this suggestion. First, dominant theories (agency theory and scarcity theory) were applied to investigate firms' franchise motivations and their impact on financial performance. The second goal was to fully understand the financial performance of the franchise using multiple performance measures.

### **Methodology**

This study focuses on the US restaurant industry, an important component of the US economy. The reason for this study to select US restaurants as the field of study is the fact that US restaurants generated \$ 1.3 trillion in revenues, operated 935,000 outlets, and employed 12.8 million people (National Restaurant Association, 2016). Moreover, Bradach (1998) noted that restaurant chains are an increasingly important force in the franchise industry. Franchising is the most common organizational form of the restaurant industry in terms of both dollar sales and sales points, with sufficient examples for empirical analysis (Kostecka, 1987). In addition, the restaurant industry is particularly useful for studying because it represents a relatively mature segment of the fast-growing business-format-chain industry (Bradach, 1998). For this study, 74 sample firms were chosen from among the publicly held restaurant firms operating in the New York Stock Exchange,

American Stock Exchange and the National Association of Securities Dealers Automated Quotations systems. Secondary financial data regarding the sample is taken from a database provided by Standard & Poor's Compustat, a comprehensive database that is widely used by finance experts within the academia, government and business. From this database, all companies in the restaurant industry based on the Ministry of Labour's Standard Industrial Classification (SIC) codes, have been selected to be incorporated into the sample of the current study. With this classification, companies with Standard Industrial Code (SIC) 5810 and 5812 have been incorporated into the sample. The number of franchise units and total units, the number of states and foreign operations were collected from Bond's Franchise Directory and each company's annual 10K filings in SEC'S Edgar database. The primary objective in this study is to define the factors that motivate firms to pursue franchise contracts. It is a fact that there are various measures to collect information on profitability. The most common measures correspond to return on assets (ROA Net Income / Average Total Asset) and return on equity (ROE Net Income / Average Stock Owners Self) (Dickerson et al., 1997). In this study, both ROA and ROE were used to explain the firm's determinative financial performance. In addition, alternative performance measures have been used in this study because traditional financial performance metrics such as ROA and ROE do not have a formal connection with shareholder value. It is thought that the risks are not clearly taken into account and that they do not echo the opportunity cost of the capital used. Shareholder values depend on the amount of return, risk and capital invested. A significant problem with traditional financial performance measures such as ROE and ROA is the following: they may not be consistent with shareholder value maximization. On the other hand, EVA and MVA were found to be consistent with the value maximization of shareholders (Stewart, 1994; Grant, 1996; Uyemura, Kantor and Pettit, 1996; O'Byrne, 1996, 1997). Over the past decade, EVA (Economic Value Added) and MVA (Market Value Added) has become an important management tool for many corporations. For this reason, both traditional financial performance measures and alternative performance measures have been used to compare both outcomes.

## **Conclusions**

The most prevalent theories explaining the franchise phenomenon suggest that the firm's preference for expanding through franchising might have significant advantages over firms that grow on their own. The franchises grow rapidly, reduce capital requirements, reduce monitoring costs and reduce risks by allowing franchisees to use managerial and financial resources of franchise owners (Allon, 2001; Srinivasan, 2006). Consequently, aforementioned advantages should provide franchising firms with superior financial performance. It is expected that the franchising enterprises outperform full ownership and create additional economic, market and shareholder value. Moreover, franchising can be thought to be useful in managing demand growth and uncertainty, and in providing the firm with more knowledge and intellectual assets which can eventually lead to increase in future cash flows while reducing risks (Srinivasan, 2006; Srivastava et al., 1998). For this reason, franchising should increase the financial performance and value of the company.

## **References**

- Allon, I. (2001). "The use of franchising by U.S.-based retailers", *Journal of Small Business Management*, Vol. 39 No.2, pp. 111-122.



- Aliouche, E.H. and Schlenrich, U. (2005). "Does franchising create value? An analysis of the financial performance of US public restaurant firms", In: *Proceedings of the Annual International Society of Franchising Conference*.
- Anderson, E.E. (1984). "The growth and performance of franchise systems company versus franchise ownership", *Journal of Economics and Business*, Vol, 36, pp. 421–431.
- Bradach, L.J. (1998). *Franchise Organizations*. Harvard Business School Press, Boston, MA
- Brickely, J.A. and Dark, F.H. (1987). "The choice of organizational form: the case of franchising. *Journal of Financial Economics*, Vol. 18, pp. 401–420.
- Carney, M. and Gedajlovic, C. (1991). "Vertical integration in franchise system: agency theory and resources explanations", *Strategic Management Journal*, Vol. 12 No.8, pp. 607– 629
- Combs, J.G. and Ketchen Jr., D. (1999). "Can capital scarcity help agency theory explain franchising? Revisiting the capital scarcity hypothesis", *Academy of Management Journal*, Vol.42 No.2, pp. 196–207.
- Combs, J.G., Michael, S.C. and Castrogiovanni, G.J. (2004). "Franchising: a review and avenues to greater theoretical diversity", *Journal of Management*, Vol.30 No.6, pp. 907–931.
- Dickerson, A.P., Gibson, H.D. and Tsakalotos, E. (1997). "The impact of acquisitions on company performance: evidence from a large panel of UK firms", *Oxford Economic Papers*, Vol.49 No.3, pp. 344–361.
- Elango, B. and Fried, V.H. (1997). "Franchising research: A literature review and synthesis", *Journal of Small Business Management*, Vol. 35 No.3, pp. 68–81.
- Grant, J. L. (1996). "Foundations of EVA for investment managers", *Journal of Portfolio Management*, Vol. 23 No.10, pp. 41–48.
- Hsu, L.T. and Jiang, S. (2008). "Advertising expenditure, market value and risk: a study of restaurant companies", *International Journal of Hospitality Management*, Vol.27, pp.259–267.
- Hunt, S.D. (1973). "The trend toward company-operated units in franchise chains", *Journal of Retailing*, Vol. 49 No.2, pp. 3–12.
- Kostecka, A. (1987). *Franchising in the economy, 1985–1987*. Washington, DC: US Department of Commerce.
- Matheson, G. and Winter, R. (1985). "The economics of franchise contracts", *Journal of Law and Political Economy*, Vol. 28, pp.503–526.
- Michael, S. C. (2002). "Can a franchise chain coordinate?", *Journal of Business Venturing*, Vol. 17, pp. 325–341.
- National Restaurant Association. (2016). Increased restaurant industry sales, employment growth predicted in 2016 by National Restaurant Association economic forecast [News release]. Retrieved March 10, 2018, from <http://www.restaurant.org/Industry-Impact/Employing-America>.
- Norton, S.W. (1988). "An empirical look at franchising as an organizational form", *Journal of Business*, Vol.61 No. 2, pp. 197–217.
- O'Byrne, S. F. (1996). "EVA and market value", *Journal of Applied Corporate Finance*, Vol.9 No.1, pp. 116–125.
- O'Byrne, S. F. (1997). "EVA and shareholder return", *Financial Practice and Education*, Vol. 7 No.1, pp.50–54.
- Sen, K.C. (1998). "The use of franchising as a growth strategy by US restaurant franchisors", *Journal of Consumer Marketing*, Vol.15 No.4, pp.397–407.
- Shane, S. A. (1996). "Hybrid organizational arrangements and their implications for firm growth and survival: A study of new franchisors", *Academy of Management Journal*, Vol.39, pp. 216–234.
- Shane, S. (1998). "Explaining the distribution of franchised and company-owned outlets in franchise systems", *Journal of Management*, Vol.24 No.6, pp. 717–739.
- Srinivasan, R. (2006). "Dual distribution and intangible firm value: franchising in restaurant chains", *Journal of Marketing*, Vol. 70 No.3, pp.120–135.
- Srivastava, R.K., Shervani, T.A. and Fahey, L. (1998). "Market-based assets and shareholder value: a framework for analysis", *Journal of Marketing*, Vol.62 No.1, pp. 2–18.
- Stewart, G. B. (1994). "EVA: Fact and fantasy", *Journal of Applied Corporate Finance*, Vol.7 No.2, pp. 71–84.
- Uyemura, D. G., Kantor, C. C., and Pettit, J. M. (1996). "EVA for banks: Value creation, risk management, and profitability measurement", *Journal of Applied Corporate Finance*, Vol. 9 No.2, pp. 94–113.

# **Factors Affecting Usage Intention of Mobile Banking: Empirical Evidence From Turkey**

Aytac Erdem, Ufuk Pala, Ugur Sevim, and Mustafa Ozkan

Faculty of Economics and Administrative Sciences  
Giresun University, Turkey

## **Abstract**

Mobile banking is defined as a mobile information processing application which gives customers opportunity to make banking transactions anywhere and at any time via smartphones. When the development of mobile banking technologies is examined, it is noteworthy to express that such technologies have been rapidly adopted all over the world. One of the best examples in terms of understanding this development is Turkey. Despite the fact that Turkey was relatively late to integrate mobile banking technology in comparison to similar countries, it showed a much more rapid progress in this regard. In this sense, it will be useful to examine Turkey in terms of explaining the mobile banking adoption factors.

There are several recent studies focused on mobile banking in the literature. Shaikh and Karjaluoto (2015) conducted a literature research regarding the mobile banking use of individuals. The results of the study showed that the most important factor in the use of mobile banking services in both developed and developing countries is the perceived usefulness. Malaquias & Hwang (2016) examined the factors affecting trust in mobile banking from the viewpoint of developing countries. As a result of the study, they found that there is a negative relationship between trust and the use of mobile banking for the undergraduate individuals. Albashrawi & Motiwalla (2017) investigated the privacy and personalization in terms of continued usage of mobile banking. The results revealed that perceived usefulness and perceived ease of use have a significant impact on mobile banking usage. Siddhartha et al. (2011) investigated the factors affecting behavioral intentions toward mobile banking usage in India. As a result of the study, they found that factors like perceived image, perceived value, self-efficacy, perceived credibility and tradition affect behavioral intentions towards mobile banking usage.

## **Methodology**

Population of the study consisted of individuals who benefit from the banking services in Turkey. In this context, bank customers living in different regions of Turkey constitute the sample of the study. As a sampling method, convenience sampling which is one of the improbable sampling methods has been used. The measurement development and hypotheses were based on the earlier literature on mobile banking.

Banking customers need to trust in mobile banking. Problems like viruses or Trojan horses may increase users' concern about payment security and can affect customers' intention to use mobile banking (Zhou, 2012). A number of studies show a direct significant effect of trust on usage intention (Alalwan et al., 2017; Malaquias & Hwang, 2016). However, trust has an effect on perceived risk. This study aims to find the effect of trust on perceived risk before intention to use. In this regard, the following hypothesis is developed: H1: Trust is negatively associated with perceived risk. Quality reflects the quality of information such as information relevancy, accuracy

and timeliness (Kim et al, 2009) and quality of services such as ease-of-use, visual appeal etc. (Zhou, 2011). If mobile banking systems do not give sufficient information about the transactions or have poor services, this will decrease customers' perceived benefit of mobile banking usage. Therefore, the following hypothesis is developed: H2: Quality is positively associated with perceived benefit.

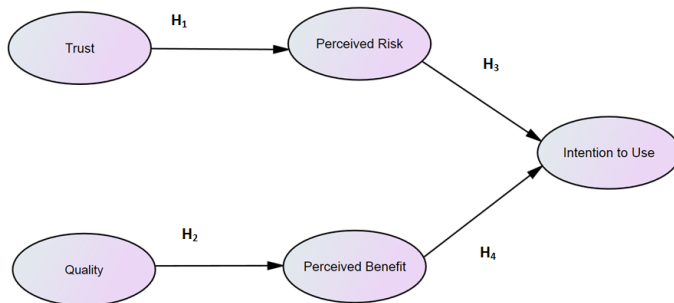

Figure 1. Model

Perceived risk is defined in terms of the uncertainty and unfavorable consequences associated with consumers' expectation (Bauer, 1960). Perceived risk plays an important role of catalyst in many online financial transactions and also in mobile banking transactions (Kesharwani et al., 2012). Perceived risk would lower consumers' intention to use mobile banking because of uncertainty. However,

consumers would be willing to transact if their risk perceptions were low. Thus, lower risk perception may increase the intention to use mobile banking. In this regard, it is hypothesized that: H3: Perceived risk is negatively associated with intention to use. In recent studies of mobile banking, it has been suggested that customers buy a product with cognitive and affective evaluation (Kim et al, 2007). For this reason, perceived benefit is found as an important factor in understanding mobile banking (Akturan & Tezcan, 2012). Intention to use mobile banking directly affects perceptions about mobile banking. If perceived benefit of mobile banking usage is positive, the intention to use mobile banking increases. Therefore, it is hypothesized that: H4: Perceived benefit is positively associated with intention to use.

## Findings and Conclusion

After examining all questionnaires, the ones which have too many missing values have been removed. As a result, 224 valid responses have been obtained. Explanatory factor analysis was applied to all scale items used in the research and since the factor loads were below 0,50 values, some items were subtracted from the trust, quality, perceived risk and perceived benefit scales. Anderson and Gerbing (1988) approach was followed in the implementation of the structural equality model. Firstly, data were tested for validity and reliability by applying data confirmatory factor analysis. Validity includes both convergent validity and discriminant validity. All AVEs exceed 0.5 and all CRs exceed 0.7. Thus, the scale has a good convergent validity. Secondly, structural hypotheses were tested with structural equation modeling. The model fitness statistics are shown in Table 1 and the validity and reliability analysis results are given in Table 2.

Table 1. Summary of Fitness Statistics

	Chi2/df	GFI	AGFI	IFI	CFI	Rmse
Recommended value	≤ 3	≥ 0,90	≥ 0,80	≥ 0,90	≥ 0,90	≤ 0,06
Confirmatory factor analysis	1,66	0,90	0,87	0,96	0,96	0,05
Structural Model	1,59	0,90	0,87	0,96	0,96	0,05

\*chi2/df is the ratio between Chi-square and degrees of freedom, GFI is Goodness of Fit Index, AGFI is the Adjusted Goodness of Fit Index, CFI is the Comparative Fit Index, IFI is the Incremental Fit Index, RMSEA is Root Mean Square Error of Approximation

**Table 2.** The Validity and Reliability Analysis Results

	CR	AVE	MSV	MaxR(H)	perrisk	trust	quality	intention	perben
perrisk	0,782	0,544	0,457	0,783	0,738				
trust	0,866	0,617	0,524	0,867	-0,676	0,786			
quality	0,874	0,537	0,524	0,878	-0,508	0,724	0,733		
intention	0,885	0,721	0,511	0,894	-0,488	0,707	0,635	0,849	
perben	0,895	0,741	0,511	0,917	-0,348	0,459	0,504	0,715	0,861

\*Composite reliability (CR) for all scales exceed 0.7 and Average variance extracted (AVE) exceed 0.5 which is a convergent validity criteria. The criteria for discriminant validity (MSV<AVE; ASV<AVE; the square root of the AVE must be higher than the correlations with another factor) are all provided (Table 2).

**Table 3.** Structural Equation Model Analysis Results

Independent Var.	Dependent Var.	Estimate Value	Standard Error	Critical Ratio	Significance	Hypothesis
Trust	Perceived Risk	-,835	,100	-8,320	***	H1 Accepted
Quality	Perceived Benefit	,456	,066	6,895	***	H2 Accepted
Perceived Risk	Intention	-,180	,055	-3,287	0,001	H3 Accepted
Perceived Benefit	Intention	1,374	,182	7,531	***	H4 Accepted

In this study, it is aimed to examine the effect of perceived risk and benefit on intention to use mobile banking. Results show that, while trust has a negative relationship with perceived risk, quality has a positive relationship with perceived benefit. Perceived risk has a negative effect on intention to use, perceived benefit has a positive effect on intention to use mobile banking. This study examines the factors influencing the mobile banking and constitutes a risk-benefit model of mobile banking usage intention.

**Keywords:** intention to use, mobile banking, Turkey

## References

- Akturan, U., & Tezcan, N. (2012). Mobile banking adoption of the youth market: Perceptions and intentions. *Marketing Intelligence & Planning*, 30, 444-459.
- Alalwan, A., Dwivedi, Y., & Rana, N. (2017). Factors influencing adoption of mobile banking by Jordanian bank customers: Extending UTAUT2 with trust. *International Journal of Information Management*, 37, 99-110.
- Albashrawi, M., & Motiwalla, L. (2017). Privacy and Personalization in Continued Usage Intention of Mobile Banking: An Integrative Perspective. *Information Systems Frontiers*, 1-13.
- Anderson, J. C. & Gerbing, D. W. (1988). Structural Equation Modeling in Practice: A Review and Recommended Two-Step Approach. *Psychological Bulletin*, 103(3), 411-423.
- Bauer, R.A. (1960). *Consumer Behavior as Risk Taking*. Risk Taking and Information Handling in Consumer Behavior, Boston, Boston University Press, 23-33.
- Kim, G., Shin, B., & Lee, H.G. (2009). Understanding dynamics between initial trust and usage intentions of mobile banking. *Information Systems Journal*, 19(3), 283-311.
- Malaquias, R. F., & Hwang, Y. (2016). An empirical study on trust in mobile banking: A developing country perspective. *Computers in Human Behavior*, 54, 453-461.
- Shaikh A. A., & Karjaluoto H. (2015). Mobile banking adoption: A literature review. *Telematics and Informatics*, 32(1), 129-142.
- Siddharta, D., Rik, P. & Sanjay, F. (2011). Factors Affecting Behavioral Intentions Towards Mobile Banking Usage: Empirical Evidence from India. *Romanian Journal of Marketing*, 6(1), 6-28.
- Ullman, J. B. (2001). Structural equation modeling. In B. G. Tabachnick & L. S. Fidell (2001). *Using Multivariate Statistics* (4th ed & pp 653- 771). Needham Heights, MA: Allyn & Bacon.
- Zhou, T. (2011). An empirical examination of initial trust in mobile banking. *Internet Research*, 21(5), 527-540.
- Zhou, T. (2012). Understanding users' initial trust in mobile banking: An elaboration likelihood perspective. *Computers in Human Behavior*, 28, 1518-1525.

# Trends and Performance of Travel and Leisure Indices

Tuba Sevil<sup>1</sup>, Usman M. Umer<sup>2</sup>, and Güven Sevil<sup>2</sup>

<sup>1</sup>Sport Science Faculty  
Anadolu University, Turkey

<sup>2</sup>Open Education Faculty  
Anadolu University, Turkey

## Abstract

Travel and leisure has become among the most important economic activities around the world. It comprises numerous sub-sectors operate in a wide business segments including airlines, hotels, gambling, restaurant, bars, recreational services, travel, tourism and tour operating companies. According to the World Travel & Tourism Council (2017) report travel and tourism contributed \$7.6 trillion USD (10% of global GDP) and 292 million jobs (equivalent to 1 in 10 jobs) to the global economy in 2016, and the leisure travel spending comprises of 76.8% of travel and tourism direct contribution to global GDP. This primarily reflects a significant role of this industry in the global economy.

Travel and leisure industry has experienced continues expansion during the past periods and become virtually among the fastest economic sectors in the world. According to the World Tourism Organization (UNWTO, 2017), international tourist arrivals have surged 1.23 billion in 2016 from a mere 25 million in 1950. This sector recorded an average consecutive robust growth of 3.9% even during the post Global Financial Crisis. This makes Travel and Tourism industry growing as faster as other significant sector such as financial services, automotive and health care.

Numerous studies investigate the relationship between economic growth and expansion of travel and leisure sector in the destination countries. Some studies argue the economic driven tourism growth, while others tourism lead economic growth. Balaguer and Cantavella–Jorda (2002) argue that tourists spending for both business and travel have a positive contribute to the foreign exchange earnings and balance of payment and consequently to the national economy. They discover a stable long-run association of economic growth with tourism expansion in Spain. Durbarry (2002) and Kim H. et al., (2006) mention other economic benefits such as employments, tax revenues and additional sources of income that derive from of tourism activates. Other researchers explore the inter-linkage between tourism expansion and economic development. Dritsakis (2004) reported the long-term impact of tourism in the economic growth of Greece. On the other hand, other studies such as Lanza et al. (2003) and Narayan (2004) report economic-driven tourism growth.

Several performance measures have been proposed by different studies. Stephens and Bartunek (1997) used economic value added as a performance measure by subtracting the cost capital involved from the profit generated. While others employ stock return performance to measure firm's performance. For instance, the traditional capital asset pricing model (CAPM) which was proposed by Sharpe (1964), Lintner (1965) and Mossin (1966) helps to measure the average excess return for the assumed risk. Fama & French (1995) also employ the stock excess return measure using the CAPM to measure firm's performance. Gu's (1994) used two common performance measures in finance, the Sharp and Treynor ratios, to examine the portfolio performance of hotel, restaurant and casino sectors during 1983-1992. Kim et al. (2002) employ Jensen index

performance measure to analyses the risk adjusted performance of hotel REIT. Mao and Gu (2007) study the risk adjusted performance of three hospitality sectors stocks, hotel/motel, casino/gaming and restaurant, using four performance measures Sharpe ratio, Treynor ratio, Jensen ratio, and Appraisal ratio between 2000-2003. They present evidence that casino/gaming sector stocks performed better in contrast to the underperformance documented in stock return of hotel/motel sector.

An investment that yields higher return for a given risk level or have less risk for a given level of expected return considered as attractive investment. A risk-adjusted investment measures helps to fully understand the performance of a fund or certain industry under a certain risk level. These measures are applicable in varies firms and asset classes to gauge how well the funds are perform relative to other classes. Several studies assess the stock performance of different companies. For example, Ofek and Richardson (2003) found that the stock returns of information technology companies are more volatile that other sectors of economy. Corgel and de Roos (1997) examined the volatility of lodging companies during the year 1984-1993 and reported the existence of high volatility return compared with real-estate firms. Firstenberg, et al., (1988) discover that hotel firms have higher risk and returns compared with other property classes.

Even though, the relationship between travel and leisure expansion and economic growth has been explore by numerous studies, the broad risk-adjusted stock performance of this sector has paid little attention by previous researchers. Owing to the unique characteristics of this sector, this study attempts to explore whether this particular sector stock returns outperform the broad market during the study period. This study, therefore, complements the extant literature and provides important new evidence which helps stock investors or portfolio managers to better understand the feature and performance of travel and leisure sector to manage their portfolio and make more informed investment decisions.

In order to understand how the theoretical framework is applied in this study, it is necessary to explain how the methods and theories that have been used in order to obtain the numerical results. According to classical finance theory, the outperformance of the any asset can only be explained by measuring how much risk is involved in producing a given returns. Many models are developed to measure the performance of financial assets. Some of these models are the classic models like the Sharpe Ratio, the Jensen measure and the Treynor ratio. As argued by Eling & Schuhmacher, (2007) the choice of measurement does not affect the outcome in such a way that would have been expected to be. Hence, we employ the classical risk-adjusted performance measures to answer the question whether travel and leisure sector outperforms the broad market.

In this paper we investigate the performance of travel and leisure indices relative to the benchmark global index. The data set includes daily returns of FTSE travel and leisure index of Turkey, U.K., France, U.S. and World travel and leisure index. We used FTSE world as a broad representation of travel and leisure sector, and S&P 500 as a proxy of the overall market. The sample period ranges from January 1994 to December 2017. Travel and leisure sector is one of the largest and diverse classifications of FTSE. Several performance measures have been proposed by different studies. For instance, using economic value added as a performance measure by subtracting the cost capital involved from the profit generated or by employing stock return performance to measure firm's performance. In this study we use widely known and industry standard performance measures in finance, such as the Sharp and Treynor ratios, to examine the index

performance. Sharpe ratio indicates the ratio of the excess return to standard deviation of any portfolio or asset. Sharpe Ratio measures return per unit of risk represented by variance. While, the Treynor ratio uses beta as the volatility measure, which divide the investment's excess return over the beta. These measures calculate the risk-adjusted return and assess whether indices excess returns are as a result of much risk or due to smart investment decisions.

Moreover, we also compute cumulative returns of each indices by investing one dollar at the beginning of sample period. The world travel and leisure index is more strongly correlated with the U.S. index. A strong correlation also found between U.S. travel and leisure and the market returns, conversely there is no significant correlation between U.S. or market returns and Turkey. The result shows that apart from Turkey the performance of other countries is relatively less than the market. The returns of U.S. travel and leisure index outperforms the world benchmark. The result shows that the returns of Turkey travel and leisure index outperforms other indices with the corresponding higher drawdown. However, the Sharpe and Treynor ratios of most travel and leisure indices are less than the market. The finding of this study may have important contribution in the academic literature, optimal portfolio decisions and for investors to make investment decisions.

**Keywords:** risk-adjusted performance, financial ratios, travel and leisure, stock indices

## References

- Balaguer, J and Cantavella-Jorda, M. (2002). Tourism as a Long-run Economic Growth Factor: The Spanish Case, *Applied Economics* 34, 877 - 884.
- Corgel, J. B., and DeRoos, J. A. (1997). Hotel investments in the portfolio: Are they part of the core? *Real Estate Finance*, 14 (2), 29-37.
- Dritsakis, N. (2004). Tourism as a long-run economic growth factor: An empirical investigation for Greece using causality analysis, *Tourism Economics* 10 (3), 305–316.
- Durberry, R. (2002). The economic contribution of tourism in Mauritius. *Annals of Tourism Research*, 29(3), 862-865.
- Fama, E and French, K (1995). Size and book-to-market factors in earnings and returns. *Journal of Finance*, 50(1), 131-155.
- Firstenberg, P., S. Ross and R. Zisler. (1988). Real Estate: The Whole Story. *Journal of Portfolio Management* 14(3), 22-34.
- Eling, M., and Schuhmacher, F. (2007). Does the choice of performance measure influence the evaluation of hedge funds. *Journal of Banking & Finance*, 2632-2647.
- Gu, Z. (1994). Hospitality investment risk, return, and performance indexes: a ten-year examination. *Hospitality Research Journal* 17(3), 17–26.
- Kim, H., Mattila, A. S., and Gu, Z. (2002). Performance of hotel real estate investment trusts: a comparative analysis of Jensen indexes. *International Journal of Hospitality Management*, 21 (1), 85–97.
- Kim, H.J., Chen, M., and Jan, S. (2006). Tourism expansion and economic development: The case of Taiwan. *Tourism Management*, 27(5), 925-933.
- Lanza, A., Temple, P., and Urga, G. (2003). The implications of tourism specification in the long run: an econometric analysis for 13 OECD economies. *Tourism Management* 24, 315–321.
- Lintner, J., (1965). The Valuation of Risky Assets and the Selection of Risky Investments in Stock Portfolios and Capital Budgets. *Review of Economics and Statistics* 47, 13–37.
- Mao, Z., and Gu, Z. (2007). Risk-adjusted stock performance: A cross-sector analysis of hospitality firms in the recent economic downturn. *International Journal of Hospitality and Tourism Administration*, 8 (4), 77–98.
- Mossin, J., (1966). Equilibrium in a Capital Asset Market. *Econometrica* 35, 768–83.
- Narayan, P.K. (2004). Economic impact of tourism on Fiji's economy: empirical evidence from the computable general equilibrium model. *Tourism Economics* 10(4), 419–433.

- Ofek, E. and Richardson, M. (2003). Dotcom mania: The rise and fall of Internet stock prices. *The Journal of Finance*, 58(3), 1113-1138.
- Sharpe, W. F., (1964). Capital Asset Prices: A Theory of Market Equilibrium under Conditions of Risk. *Journal of Finance* 19, 425–442.
- Stephens, K., Bartunek, R. (1997). What is economic value added? A practitioner’s view. *Business Credit*, 99(4), 39-42.
- UNWTO (2017). World tourism Highlight. Retrieved from <https://www.e-unwto.org/doi/pdf/10.18111/9789284419029>
- World Travel & Tourism Council (2017). Travel & tourism economic impact 2017 world. Retrieved from <https://www.wttc.org/-/media/files/reports/economic-impact-research/regions-2017/world2017.pdf>



# Revisiting the Spot-Future Relationships: Case of Emerging Stock Markets

Güven Sevil<sup>1</sup>, Melik Kamışlı<sup>2</sup>, Serap Kamışlı<sup>2</sup>, Tuba Sevil<sup>3</sup>, and Fatih Temizel<sup>4</sup>

<sup>1</sup> Open Education Faculty  
Anadolu University, Turkey

<sup>2</sup>Bilecik University, Turkey

<sup>3</sup>Sport Science Faculty  
Anadolu University, Turkey

<sup>4</sup>Faculty of Economics and Administrative Sciences  
Anadolu University, Turkey

## Abstract

Minimizing future risks and efficient risk management are the fundamental functions of futures markets. Price discovery in futures and spot markets involves exploring the close relationship of these two markets in order to detect which one initially processes the information. Efficient market hypothesis argues that the prices reflect the information in a similar way. However, in practice, markets are not efficient, and one market can trace another. Besides, volatility spillovers are important factors which generate interactions between spot and futures markets. Shocks in different markets tend to increase volatility in other markets due to globalization. Volatility of a financial variable may spread to another variable through linkages between financial variables after a shock, event or crisis. This is defined as volatility spillover and indicates a dynamic relationship between variables. Price changes in one market are linked to its own dynamics and also to price changes in other financial markets. This effect induces recent studies to examine the determinants of spot and futures markets volatility spillovers.

Investors may use spot and future indices as well as basic financial assets in order to diversify their portfolios efficiently. Besides, the absence of volatility spillover between the assets included in the portfolio enables investors to reduce their risks through portfolio diversification. However, global and regional shocks affect volatility spillovers between spot and futures markets of each country in a different way. Certain volatility spillovers between spot and futures indices are effective in all analysis periods, while others are valid only in short-term, mid-term and long-term periods and it decreases the benefits of portfolio diversification for investors. Hence, it is important to analyze the directions and frequencies of the volatility spillovers in short-term, mid-term and long-term periods so that investors are able to determine healthy portfolio management policies, risk management strategies and investment timing decisions.

Volatility spillovers can exist between futures markets as well as financial and macro-economic variables like bonds, currencies and interest rates. In other words, spillovers impact multiple different economic and financial variables. Thus, detecting volatility spillovers and their sources has great importance for policy makers as volatility spillovers affect the operation of financial institutions and markets.

The most widely used method for analyzing volatility is variance causality tests. Variance causality tests are developed by Cheung and Ng (1996), Hong (2001) and Hafner and Herwartz (2006), and mainly used to determine the directions of volatility spillovers in literature. Alaganar and Bahr (2003), Neaime (2006), Yalama (2008) and Köseoğlu and Çevik (2013) employed variance causality tests in order to investigate volatility spillovers between different financial market. In the

literature there are a limited number of studies that analyze volatility spillovers using Hafner-Herwartz variance causality test. For additional details refer Görmüş, 2012; Nazlıoğlu et. al.,2013; Zhang et. al 2013. Moreover, Balcılar vd. (2010), Arslantürk et. al. (2011), Tang and Tan (2013), Balcılar and Özdemir (2013) and Tiwari and Ludwig (2014) investigated the relationship between financial assets using time-dependent causality tests. Ciner (2011b), Mermod and Dudzeviciute (2011), Ciner (2011a), Aslanoğlu and Deniz (2012), Ciner (2011c), Croux and Reusens (2013), Bozoklu and Yılcı (2013), Joseph et. al (2014) and Tiwari (2014) examine the relationship between different financial markets and macro-economic variables and volatility spillovers using the method of Breitung-Candelon (2006) frequency-based causality analysis.

Literature review demonstrates that there are many studies which investigate volatility spillovers between spot and future market using different data sets and econometric approaches. However, optimal risk and portfolio management can only be achieved by detailed analysis of volatility spillovers. Therefore, explanation of the directions and time aspects of volatility spillovers between spot and futures indices is highly important. Different aspects seem to be neglected in the worlds' spot and future market volatility spillover studies. The main objective of this study is to determine direction and frequency aspects of volatility spillovers between spot and future stock indices of developing countries. The analysis is based on Hafner and Herwartz (2006) variance causality test and Breitung-Candelon (2006) frequency causality test that employ volatility series obtained by GARCH (1,1) model. This study may overcome an important caveat in the literature owing to the fact that it will examine different aspects of volatility spillovers between spot and futures markets of developing countries.

Main hypothesis of the study is shown below:

- $H_0$ : There are no volatility spillovers between developing countries' spot and futures markets
- $H_1$ : There are volatility spillovers between developing countries' spot and futures markets in short-term, mid-term and long-term periods

Although there are various previous studies on volatility spillover analysis with the purpose of determining relationships between different financial assets and markets, there is a limited number of studies which investigate world spot and future market volatility spillovers. This study may provide important contributions to the existing literature and may guide investors who require to benefit from international diversification by investing in spot and future markets in developing countries.

The study analyzes data in the period between September 15, 2008 and December 26, 2017. The data sets are future and spot indices of developing countries which are Brazil (Sao Paulo Commodity and Futures Exchange), China (CSI300 Index Future), Hong Kong (HSCEI Index Future), Hungary (Budapest Stock Exchange), India (CNX Index Future), Indonesia (LQ45 Index Future), Korea (KOSPI 200 Futures), Malaysia (FTSE Bursa KLCI Futures), Mexico (Mercado Mexicano de Derivados-Futures), Poland (WIG40 Index Future), Portugal (PSI20 Index Future), Singapore (FTSESIT Index Future), Taiwan (TWSE50 Index Future), Thailand (SET50 Index Futures). The data is obtained from Thomson & Reuters Datastream in a weekly frequency.

Hafner and Herwartz (2006) causality in variance test shows that in countries other than Hungary, Mexico, Malaysia, Singapore and Thailand, futures market volatility causes spot market volatility. However, this test shows only spillover direction. Information regarding time aspects are not provided. Therefore, Breitung-Candelon (2006) frequency causality test of volatility series obtained by GARCH (1,1) model is used and different frequency volatility spillovers from futures index to spot index are evidenced.

In this study, frequency causality test results show similar findings with Hafner and Herwartz (2006) causality in variance tests. No volatility spillovers are detected between Mexico future and spot index. China, India, Korea, Poland, Taiwan and Thailand future indices have volatility spillovers in all frequencies. Besides, the results demonstrate that Brasil, Hong Kong, Hungary, Indonesia, Malaysia, Portugal, Singapore and Turkey indices have volatility spillovers from future indices to spot indices in certain frequencies. In conclusion, futures markets of the developing countries generally impact their spot market volatilities in different frequencies.

**Keywords:** volatility spillover, causality in variance tests, spot and future markets, developing countries

## References

- Alaganar, V. T. & Bahr, R. (2003). An international study of causality-in-variance: Interest rate and financial returns. *Journal of Economics and Finance*, 27 (1), 39-55. <http://dx.doi.org/10.1007/BF02751589>
- Arslantürk, Y.; Balcilar, M. & Özdemir, Z. A. (2011). Time-varying linkages between tourism receipts and economic growth in a small open economy. *Economic Modelling*, 28, 664-671. <http://dx.doi.org/10.1016/j.econmod.2010.06.003>
- Aslanoğlu, E. ve Deniz, P. (2012). How does stability in financial openness affect growth?. *Topics in Middle Eastern and African Economies*, 14, 164-189.
- Balcilar, M.; Özdemir, Z. A. & Arslantürk, Y. (2010). Economic growth and energy consumption causal nexus viewed through a bootstrap rolling window. *Energy Economics*, 32, 1398-1410. <http://dx.doi.org/10.1016/j.eneco.2010.05.015>
- Balcilar, M. & Özdemir, Z. A. (2013). The export-output growth nexus in Japan: a bootstrap rolling window approach. *Empirical Economics*, 44 (2), 639-660. <http://dx.doi.org/10.1007/s00181-012-0562-8>
- Bozoklu, S. ve Yılcı, V. (2013). Energy consumption and economic growth for selected OECD countries: Further evidence from the Granger causality test in the frequency domain. *Energy Policy*, 63, 877-881. <https://doi.org/10.1016/j.enpol.2013.09.037>
- Breitung, J. ve Candelon, B. (2006). Testing for short and long-run causality: A frequency-domain approach. *Journal of Econometrics*, 132, 363-378. <https://doi.org/10.1016/j.jeconom.2005.02.004>
- Cheung, Y. W. & Ng, L. K. (1996). A causality in variance test and its application to financial market prices. *Journal of Econometrics*, 72, 33-48. [http://dx.doi.org/10.1016/0304-4076\(94\)01714-X](http://dx.doi.org/10.1016/0304-4076(94)01714-X)
- Ciner, Ç. (2011a). Commodity prices and inflation: Testing in the frequency domain. *Research in International Business and Finance*, 25, 229-237. <https://doi.org/10.1016/j.ribaf.2011.02.001>
- Ciner, Ç. (2011b). Information transmission across currency futures markets: Evidence from frequency domain tests. *International Review of Financial Analysis*, 20, 134-139. <https://doi.org/10.1016/j.irfa.2011.02.010>
- Ciner, Ç. (2011c). Eurocurrency interest rate linkages: A frequency domain analysis. *International Review of Economics and Finance*, 20, 498-505. <https://doi.org/10.1016/j.iref.2010.09.006>
- Croux, Ç. ve Reusens, P. (2013). Do stock prices contain predictive power for the future economic activity? A Granger causality analysis in the frequency domain. *Journal of Macroeconomics*, 35, 93-103. <https://doi.org/10.1016/j.jmacro.2012.10.001>
- Görmüş, A. N. (2012). Causality and volatility spillover effects on sub-sector energy portfolios (Doctoral dissertation). Texas: The University of Texas at Arlington.
- Hafner, C. M. & Herwartz, H. (2006). A Lagrange multiplier test for causality in variance. *Economics Letters*, 93, 137-141. <http://dx.doi.org/10.1016/j.econlet.2006.04.008>

- Hong, Y. (2001). A test for volatility spillover with application to exchange rates. *Journal of Econometrics*, 103, 183-224. [http://dx.doi.org/10.1016/S0304-4076\(01\)00043-4](http://dx.doi.org/10.1016/S0304-4076(01)00043-4)
- Joseph, A.; Sisodia, G. ve Tiwari, A. K. (2014). A frequency domain causality investigation between futures and spot prices of Indian commodity markets. *Economic Modelling*, 40, 250-258. <https://doi.org/10.1016/j.econmod.2014.04.019>
- Köseoğlu, S. D. & Çevik, E. I. (2013). Testing for causality in mean and variance between the stock market and the foreign exchange market: An application to the major central and eastern european countries. *Czech Journal of Economics and Finance*, 63 (1), 65-86.
- Mermoud, A. S. ve Dudzeviciute, G. (2011). Frequency domain analysis of consumer confidence, industrial production and retail sales for selected European countries. *Journal of Business Economics and Management*, 12 (4), 589-602. <https://doi.org/10.3846/16111699.2011.599406>
- Nazlıoğlu, S.; Erdem, C. & Soytaş, U. (2013). Volatility spillover between oil and agricultural commodity markets. *Energy Economics*, 36, 658-665. <http://dx.doi.org/10.1016/j.eneco.2012.11.009>
- Neaime, S. (2006). Volatilities in emerging MENA stock markets. *Thunderbird International Business Review*, 48 (4) 455-484. <http://dx.doi.org/10.1002/tie.20105>
- Tang, C. F. & Tan, E. C. (2013). How stable is the tourism-led growth hypothesis in Malaysia? Evidence from disaggregated tourism markets. *Tourism Management*, 37, 52-57. <http://dx.doi.org/10.1016/j.tourman.2012.12.014>
- Tiwari, A. K. (2014). The frequency domain causality analysis between energy consumption and income in the United States. *Economia Aplicada*, 18 (1), 51-67. <https://doi.org/10.1590/1413-8050/ea307>
- Tiwari, A. K. & Ludwig, A. (2014). The export-led growth hypothesis for India: examining causality by a new approach in the time–frequency domain. *Applied Economics Letters*, 21 (18), 1297-1301. <http://dx.doi.org/10.1080/13504851.2014.925045>
- Yalama, A. (2008). Dünya borsaları ve İMKB’de oynaklık yapısının analizi ve oynaklık etkileşimi (Doctoral dissertation). Eskişehir: Anadolu Üniversitesi.
- Zhang, J.; Zhang, D.; Wang, J. & Zhang, Y. (2013). Volatility spillovers between equity and bond markets: Evidence from G7 and BRICS. *Romanian Journal of Economic Forecasting*, 16 (4), 205-217.

# **The Enforcement of the Rule of Law in the Financial Sector: The Strategic Synergies Among Judicial Authority and Financial Supervisory Authorities**

Carlo Alberto Giusti

eCampus University, Italy

## **Abstract**

A recent research work conducted in the Bank of Italy analyzed the relationship between the slowdown in economic activity in Italy in the years of the crisis - from 2008 to 2011 – e the intensification of criminal incidents. The results show that the economic crisis had a impact only on certain types of criminal activities, ie on property and financial offenses especially on those who do not require particular criminal abilities, such as theft. In line with the recent European directives, economic crimes must be combated by pursuing both the objective of law enforcement and that of economic development. A balanced strategy of prevention and suppression must be found upon rules that lay down clearly formulated obligations; that avoid intrusive instruments and rigid procedures; that do not overburden honest businesses; that institute mechanism of enforcement and sanctions that are swift, effective and proportionate to the seriousness of the infractions; that provide incentives for intermediaries to collaborate with the structures that fight money laundering; and, in conclusion, that strengthen domestic and International cooperation among authorities. The States that are most aware of the problem, perceiving that the criminal organizations are most vulnerable when they seek to pass the proceeds of the crime into legitimate channels, have long concentrated their efforts on the protection of the financial system. Different institutional players are called to collaborate to the enforcement of the rule of law in the financial sector, and to contribute to the achievement of the results set. A major role is played by the Judiciary, by the Supervisory Authorities, the Financial Intelligence Unit (UIF) established at the Bank of Italy, and by the Investigation Authorities. It's easy to infer, therefore, that the intensity and quality of the institutional cooperation between the supervision and judicial authorities represent an essential and fundamental element to achieve an effective prevention of illegal activities, since the exchange of information on different skills. Collaboration with the judiciary helps each of the two sides to pursue in better their institutional objectives. It occurs in the awareness of the diversity of the roles performed and in full compliance with the guarantees and the rights of defense of the subjects concerned, in turn a cornerstone of the rule of law, an indispensable defense of legality. The necessary of dialogue between the Supervisory Authority and the Judicial Authority is definitely demonstrated as well as the great benefits provided at national level to the financial system. For this reasons it will must be a fundamental effort of the European Legislator to find the best way of cooperation between the European Central Bank and European Public Prosecutor Office.

**Keywords:** financial supervisory authority, European central bank, European public prosecutor office

## **Introduction**

The essential components of a good institutional system are the protection of rights fundamental rights and property, fair regulation, good administration, efficient provision of essential public services. However, there is no good governance without legality: the ability to prevent, repress and

punish illicit behavior is an integral part of a favorable institutional framework, as well as the civil growth, even in a development balanced economic. Although it is not easy to isolate the relevance of this last element compared to that of the rest of the institutional framework and other essential factors for growth (such as human capital and social), some estimates of the effects that it exert on economic development and social issues are starting to be available for our country as well. At the macro-economic level, for example, a work carried out by the Bank of Italy proposes an overall estimate of the losses - in terms of gross domestic product - that can be directly associated with organized crime.

## **Methodology**

Analysis of the data provided by the Bank of Italy, the Office of the Public Prosecutor's Office of Rome and Milan, the Financial Information Unit and the European Central Bank. The study is carried out at the level of local labor systems and the trend of the conjuncture at the local level comes represented on the basis of information from a database of company balance sheets (CERVED). The crime measures used are based on the news of crime received by the judicial authorities by the State Police.

### *Sample*

It is focused attention on the two regions of southern Italy subject to more recent infiltration, Puglia and Basilicata, comparing its economic development in the decades before and after the spread of the contagion mafia, occurred in the late '70s, with that of a group of central North regions that had similar initial socio-economic conditions.

### *Empirical Model*

The empirical results show that, concurrently with the infection, Puglia and Basilicata moved from a growth path that was superior to that of the group of regions initially similar, but not infected, to a lower one. The decrease in GDP per capita growth attributable to the onset of organized crime can be estimated at 20 percentage points in thirty years, and mainly reflects minor private investments.

## **Findings**

Due to the excellent results obtained by the strong and continuous collaboration in Italy, the Bank of Italy (banking supervisory authority) and the magistrate, also other European countries and the European Union have now perceived the need for close collaboration between the supervisory bodies and control with the common aim of countering at best organized economic crimes. In this sense, the progress made by the European Commission, which is trying to shorten the time of European Public Prosecutor Office's stabilization, is now very important, with a clear vision to strengthen the close contact between the banking supervisor (ECB) at European level. and the investigating authority (EPPO).

## **Conclusions**

Legality and economic development are interdependent. An efficient rule of law, with balanced regulation and the effective capacity to enforce it, create a environment conducive to development,

favors investment, attracts the best energies human. The widespread illegality alters the market mechanisms and upsets the incentives in favor of unproductive or harmful activities; slows growth by reducing collective well-being. Neither they achieve injustices and inefficiencies that go to the detriment of all, but especially the most honest and weaker. In the financial sector in particular, illicit and criminal interferences endanger the stability of the operators involved and the freedom and efficiency of the market. The prevention and the fight against financial crimes are therefore an essential part of the activity entrepreneurial. Strict compliance with the law is the cornerstone of sound and prudent management, on the which the Bank of Italy supervises. Unfortunately, prolonged periods of recession offer one more opportunity to crime. Yes increases the impact of some crimes against property. Vulnerability may increase individuals and businesses to usury, thus allowing crime to extend its own control over the legal economy. The fall of confidence in the financial system and in the activities that it offers increased use of cash and the use of safe haven assets such as gold and other metals valuable, facilitating the use of less traceable means of payment. The Bank of Italy is strongly committed to fighting illegality in the field financial, according to the competences and with the tools that the law assigns them. Crimes like the false accounting, recycling, patrimonial unfaithfulness, endanger integrity banking activities, interfere with supervision, alter competitive mechanisms.

## References

- Daron Acemoglu e James A. Robinson (2012), *Why Nations Fail: The Origins of Power, Prosperity, and Poverty*, Barnes & Noble.
- Gary S. Becker (1968), *Crime and punishment: an economic approach*, *Journal of Political Economy*, Vol. 76, No. 2, 169-217.
- De Blasio, Guido and Menon, Carlo (2013), *Down and out in Italian towns: measuring the impact of economic downturns on crime*, Discussion topic n. 925, July 2013, Bank of Italy (version updated in September 2013).
- "Doing Business" reports from 2013 to 2017.

# *Hospitality & Tourism*



# Analyzing Online Reviews on Hotels by Humans Versus Artificial Intelligence

Fevzi Okumus<sup>1</sup>, Ahmet Ozturk<sup>1</sup>, Anil Bilgihan<sup>2</sup>, and Chenge Jia<sup>1</sup>

<sup>1</sup>Rosen College of Hospitality Management  
University of Central Florida, USA

<sup>2</sup>College of Business  
Florida Atlantic University, USA

## Abstract

An increasing dependence on the Internet as the source of information for decision-making regarding tourism products makes it important to analyze online reviews for hoteliers. Utilizing available online customer reviews can be used to better understand and analyze guests' comments and improve the service delivery process in hotels. However, there is a vast volume of information that makes it difficult for hotel companies to review and evaluate all of it. Artificial intelligence (AI), manifested by machines that exhibit aspects of human intelligence, is increasingly utilized in services industries and today is a key source of innovation (Rust and Huang 2014). Hotel companies can greatly benefit from AI to analyze online customer reviews. The aim of this research is to assess how AI compares to humans when it comes to analyzing online reviews. We gathered open-ended online reviews for a group of Orlando-area resorts and ran three experiments. First, the data was analyzed by a graduate student who used completely manual data analysis, common tools and techniques to interpret the comments from the online reviews. Next, the data was analyzed by two researchers using Atlas.ti and SPSS Modeler. Finally, the data was analyzed by an AI engine called "Ana". The first method conducted by a graduate student took about 50 hours to analyze the data manually whereas, it took researchers about 9 hours using statistical and qualitative research analysis tools. We call this method hybrid model as it utilizes complex text mining software and human power. On the other hand, our AI engine (Ana) took about 15 minutes to uncover the same insights. The research findings suggest that using AI can greatly assist hotel companies in analyzing guests' online comments accurately and also give them more time to focus on implementation of solutions versus analyzing data.

**Keywords:** online reviews, AI, customer satisfaction, social media

## References

Rust, R. T., & Huang, M. H. (2014). The service revolution and the transformation of marketing science. *Marketing Science*, 33(2), 206-221.

# How Much Does the Consumer-Based Brand Equity Affect the Financial Performance of the Company?

Ayşegül Acar<sup>1</sup> and Mehmet Erkan<sup>2</sup>

<sup>1</sup>Safranbolu Tourism Faculty  
Karabük University, Turkey

<sup>2</sup>Faculty of Economics  
Istanbul University, Turkey

## Abstract

Brands are increasingly regarded as primary capital in many enterprises. Creating a strong brand with a large capital provides a number of possible benefits to a company like greater customer loyalty and competitive marketing actions or less vulnerability to marketing crises; larger margins; more positive customer response to price increases and decreases; more trade or intermediation cooperation and support; increased marketing communication effectiveness; licensing and brand expansion opportunities. In addition, customers develop emotions and associations with brands and remain faithful to them because of "added value" (Barwise, 1993). The cost of offering a new brand to market is \$ 100 million and has 50 percent probability for failure (Oursoff, 1993; Crawford, 1993). With the contribution of this information, it is a fact that the development of existing brands and the establishment of brand management as an institutional component of the corporate strategy is an important concept for companies seeking growth opportunities. To exemplify, instead of developing a new luxury hotel brand, Marriott International Inc. decided to buy the Ritz-Carlton, a luxury hotel chain in 1995. In doing so, Marriot Corporation continued to differentiate; Lower operational risk, limits new product introduction costs and improves corporate performance (Muller, 1998). As time goes by, companies recognize the brand's power and use it as a competitive tool to provide a sustainable advantage called brand equity. Brand equity is defined as "the differential effect of brand knowledge on the consumer response to the marketing of the brand" (Keller, 1993: 8). There are three different perspectives to consider brand equity: customer-focused viewpoint, financial viewpoint and combined viewpoint. Brand power, one of the multi-dimensional concepts of customer-focused brand equity, is based on the perceptions and behaviours of its customers, which enable the brand to benefit from sustainable and different competitive advantages. Another dimension, brand value, is the financial outcome of management's ability to use its brand power to deliver superior current and future profits through strategic activities. From a consumer perspective, the brand will generate value for the firm only when the it provides the customer with value (Aaker, 1991; Keller, 1993). In addition, Consumer-based brand equity is divided into four dimensions: brand loyalty, brand awareness, perceived quality and brand image (Aaker, 1991, 1996). It has been widely accepted and used by many researchers (Keller, 1993, Motameni and Shahrokhi, 1998, Low and Lamb Jr., 2000, Prasad and Dev, 2000, Yoo and Donthu, 2001). The financial perspective is based on the increasing discounted future cash flows arising from the income of a branded product over the income of an unbranded product (Simon and Sullivan, 1993). The asset representing the brand is included in the assets of companies in the balance sheet. Finally, the combined viewpoint covers both the market power and the financial value of the brand (Motameni and Shahrokhi, 1998). The brand will be a quick way for the hotel and restaurant chains to identify and differentiate themselves in the minds of the customers. To avoid losing time to search for restaurants and hotels in unusual locations, consumers are likely to choose restaurants and hotels with well-known brands and leading brands

over others. The concept and measurement of brand equity increased academics and practitioners more than ten years; basically, because of the importance of today's market, to protect brands and use them to gain a certain competitive advantage. It is also expected that hotels and restaurants having strong brand value will dominate higher occupancy rates and average room rates due to high customer satisfaction and a favourable price. It will result in higher operational performance, RevPar (Prasad and Dev, 2000). It also enables top executives of hospitality and restaurant businesses to compare the power of brands in a competitive set, to follow the equity of the hotel and restaurant over time, and to develop therapeutic marketing strategies (Prasad and Dev, 2000). The main objective of this study is to examine the underlying dimensions of consumer-based brand equity and its relation to the financial performance of the hotel and restaurant industry, assuming that consumer-focused brand equity consists of brand awareness, brand loyalty, perceived quality and brand image. Empirical study was carried out and two separate survey studies were conducted to collect data for hotels. The data were collected by surveys conducted at Istanbul Atatürk Airport. The reason of selecting an airport for a survey place was that most branded hotels unwilling to do surveys for customers inside their hotels. So, travellers were interviewed immediately after entering the gate of departure lounge of the airport. For financial performance analysis, it was preferred to receive 8 branded hotels located in İstanbul were chosen for survey responses. Three performance dimensions are examined. Accounting statements are measured using the company's average asset return (ROA) and sales growth is measured as the average annual increase in sales. Market performance was evaluated by average market-to-book value of the companies. Regression analyses were employed in order to examine the relationship between brand equity and firm's performance. Previous research shows that brand equity can be expressed numerically in terms of both financial and customer perceptions and attitudes. As a result, the end result of this study shows that strong brand equity can lead to a significant increase in profitability and lack of brand equity in hospitality firms can damage potential cash flow. This means if a marketer in hospitality firms does not strive to improve customer-based equity, the marketer should expect declining revenue over time.

**Keywords:** brand equity, financial performance, hotels

## References

- Barwise, P. (1993). Brand equity: Snark or Boojum?. *International Journal of Marketing Research*, 10 (March): 93-104.
- Crawford, M. (1993). *New products management*. IL: Homewood.
- Ourusoff, A. (1993). Who said brands are dead? *Brandweek*, 34(32), 20–33.
- Muller, C. C. (1998). Endorsed branding. *Cornell Hotel and Restaurant Administration Quarterly*, 39(3), 90–96.
- Keller, K. L. (1993). Conceptualizing, measuring, and managing consumer-based brand equity. *Journal of Marketing*, 57(1), 1–22.
- Aaker, D. A. (1991). *Managing brand equity*. New York: The Free Press.
- Aaker, D. A. (1996). Measuring brand equity across products and markets. *California Management Review*, 38(3), 102–120.
- Motameni, R., & Shahrokhi, M. (1998). Brand equity valuation: A global perspective. *Journal of Product and Brand Management*, 7(4), 275–290.
- Low, G. S., & Lamb Jr., C. W. (2000). The measurement and dimensionality of brand associations. *Journal of Product and Brand Management*, 9(6), 350–368.
- Prasad, K., & Dev, C. S. (2000). Managing hotel brand equity: A customer-centric framework for assessing performance. *Cornell Hotel and Restaurant Administration Quarterly*, 41(3), 22–31.
- Yoo, B., & Donthu, N. (2001). Developing and validating a multidimensional consumer-based brand equity scale. *Journal of Business Research*, 52(1), 1–14.
- Simon, C. J., & Sullivan, M. W. (1993). The measurement and determinants of brand equity: A financial approach. *Marketing Science*, 12(1), 28–52.

# How Alcoholic Beverage Etiquette Can Increase Sales

Adam Carmer

College of Hospitality & Tourism Leadership  
University of South Florida Sarasota-Manatee, USA

## **Abstract**

This paper focuses on the transient properties associated with etiquette, building trust and loyalty with guests. Understanding proper etiquette provides context for alignment of service with the establishment whereby guests are more open to suggestive selling from the employee. Etiquette is intertwined with increasing sales and decreasing guest dissatisfaction.

**Keywords:** sales, etiquette, guest loyalty, dissatisfaction, alcoholic beverages

# Corporate Environmental Policy Adoption and Environmental Disclosure: The Impact of Board Characteristics and Executive Compensation

Rose Sebastianelli and Nabil Tamimi

Kania School of Management  
University of Scranton, USA

## Abstract

This study examines how board characteristics (structure and diversity) and executive compensation related to ESG (Environmental – Social – Governance) affect corporate environmental policy adoption and environmental disclosure. Based on data for S&P 500 companies retrieved from Bloomberg, we use hierarchical regression to explore sequentially the effects of three sets of independent variables (firm characteristics, board characteristics, and executive compensation) on the extent to which firms adopt environmental policies and disclose information on environmental practices and performance.

The link between environmental management and corporate performance has been researched for decades. Porter and van der Linde (1995) argued that improving environmental performance reduces waste, increases productivity, and improves corporate performance; conversely, Walley and Whitehead (1994) argued that the costs associated with improved environmental performance are so high that firms rarely realize any financial benefits. The empirical evidence in support of the view that “it pays to be green” is mixed. In a meta-analytic review of the literature, Albertini (2013) provides some insight about the contradictory findings. She acknowledges that the environmental construct is measured by a number of variables that can be categorized into one of three types: (1) management, (2) performance, and (3) disclosure.

The impact of environmental disclosure has been addressed in the environmental accounting literature. Clarkson, et al. (2013) found a positive association between environmental performance and voluntary environmental disclosures consistent with economic drivers. Lyon and Shimshack (2015) established that media-generated sustainability rankings had a significant effect on shareholder value (i.e., highly rated firms experienced abnormal stock market returns after the disclosure of rankings). And Cormier and Magnan (2015) found that a firm’s legitimacy has a mediating effect on the relationship between environmental disclosure and financial markets (i.e., on the quality of financial analysts’ earnings forecasts).

Researchers have also explored how governance factors (i.e., board characteristics) affect voluntary environmental disclosures. Ben-Amar and McIlkenny (2014) found that the effectiveness of the board (as measured by an index that considers director independence, CEO/Chair split, etc.) is positively related to participation in the Carbon Disclosure Project (CDP). Liao, et al. (2015) concluded that board gender diversity (percentage females) is strongly correlated with both the propensity and level of disclosure on GHG (greenhouse gas) emissions (CDP report) and that board independence is positively related to the propensity of disclosure. Ben-Amar (2017) found that the likelihood of voluntary climate change disclosures increases as the percentage of women on the board increases. Our study follows along these lines of inquiry.

We use data for S&P 500 companies retrieved from Bloomberg via the Financial Analysis, Environmental, Social and Governance function. These data, collected in early 2016, are for FY 2015. Since companies are not required to disclose information on environmental policies, practices or performance, Bloomberg compiles these data from publicly available sources. Given the varying degrees of transparency among firms voluntarily reporting this information, Bloomberg determines and provides an “E” disclosure score (using a proprietary method). The E Score (Environmental Disclosure) can range from 0 (no disclosure) to 100 (full disclosure). For S&P companies, the range is 1.55 to 82.17, with a mean of 27.23.

Bloomberg also provides dichotomous (Yes=1; No=0) data representing company adoption of nine different environmental policies (Energy Efficiency, Emissions Reduction, Water Use Reduction, Sustainable Packaging, Waste Reduction, Green Building, Climate Change, Biodiversity, New Product Impact on Climate Change). In order to represent the extent to which a firm adopts environmental policies, we create a new variable for each company (Environmental Policy Adoption) by summing across the policies, dividing by 9, and multiplying by 100.

We use hierarchical regression to explore sequentially the effects of three sets of independent variables (firm characteristics, board characteristics, and executive compensation) on each dependent variable (Environmental Policy Adoption and Environmental Disclosure). As done in previous research, we control for the firm characteristics of industry, size (number of employees), risk (debt/assets), and ROE (5 year average return on equity). The board characteristics included in the model relate to structure and diversity. We use the number of independent directors, CEO duality (CEO who is also Chairman), percentage of women on the board (gender diversity) and the board’s age range (age diversity). Bloomberg provides a variable on whether or not executive compensation is linked to ESG. We use this to represent executive financial incentive to be proactive on sustainability. Since it is reasonable to assume that any effects due to governance may be lagged, we use data from fiscal year 2013 for the variables related to board characteristics and executive compensation. We implement the hierarchical approach by fitting three regression models for each dependent variable. Changes in R-Squared are evaluated using an F-test as per Cohen and Cohen (1980).

With respect to Environmental Policy Adoption, the changes in R-Squared between the first and second estimated regression models ( $F=12.73$ ) and the second and third estimated regression models ( $F=10.79$ ) are statistically significant (at  $\alpha = 0.01$ ). This indicates that the sequential addition of independent variables (board characteristics to firm characteristics and executive compensation linked to ESG to board and firm characteristics) adds significant explanatory power, with the final model explaining about 30% of the variability in the dependent variable. Controlling for significant effects due to industry and firm size, an increase in the number of independent directors and percentage of women on the board positively impacts the extent to which environmental policies are adopted; age range of the board has a negative impact. Moreover, providing a financial incentive to executives by linking compensation to ESG goals increases the extent of environmental policy adoption.

With respect to Environmental Disclosure, again the changes in R-Squared between the first and second and between the second and third estimated regression models are significant at  $\alpha = 0.01$ , with  $F=17.80$  and  $F=15.13$ , respectively. The full model explains about 33% of the variability in Bloomberg E disclosure scores. In terms of significant predictors, the results are identical to what

we find for the dependent variable Environmental Policy Adoption. That is, controlling for the significant effects due to industry and firm size, the number of independent directors, percentage of women on the board, and providing executive compensation linked to ESG all have a significant positive effect on voluntary environmental disclosure; age range of the board has a negative impact.

Our results are congruent with prior research on how governance factors affect voluntary environmental disclosures in that we too find empirical evidence for a positive impact due to board independence and gender diversity. It also extends prior research in several important ways. First, we consider how governance factors affect the extent to which firms adopt environmental policies. Our findings suggest that the same board characteristics that affect disclosure also impact environmental policy adoption, which we find to be highly correlated with disclosure ( $r = 0.746$ ;  $p\text{-value} < 0.0001$ ). Second, we use data for S&P 500 companies from a different source (Bloomberg) than other studies, which focus exclusively on the CDP. Third, no prior study has considered the effects of board characteristics and executive compensation linked to ESG goals on voluntary environmental disclosure (or environmental policy adoption). Our results suggest the importance of financially incentivizing the pursuit of goals linked to ESG.

**Keywords:** environmental disclosure, environmental policy, board structure, board diversity, executive compensation, S&P 500, ESG

## References

- Albertini, E. (2013). Does environmental management improve financial performance? A meta-analytical review, *Organization & Environment*, 24 (4), 431-457.
- Ben-Amar, W. and McIlkenny, P. (2014). Board effectiveness and voluntary disclosure of climate change information. *Business Strategy and the Environment*, DOI: 10.1002/bse.1840.
- Ben-Amar, W., Chang, M. and McIlkenny, P. (2017). Board gender diversity and corporate response to sustainability initiatives: Evidence from the Carbon Disclosure Project. *Journal of Business Ethics*, 142, 369-383.
- Clarkson, P., Li Y., Richardson, G.D. and Vasvari, F.P. (2008). Revisiting the relation between environmental performance and environmental disclosure: An empirical analysis. *Accounting, Organization and Society*, 33 (4/5), 303-327.
- Cohen, J. and Cohen, P. (1980). *Applied multiple regression/correlation analysis for the behavioral sciences*. Erlbaum Associates: Mahwah, NJ.
- Cormier, D. and Magnan, M. (2015). The economic relevance of environmental disclosure and its impact on corporate legitimacy: An empirical investigation. *Business Strategy and the Environment*, 24, 431-450.
- Lin, L., Luo, L. and Tang, Q. (2015). Gender diversity, board independence, environmental committee and greenhouse gas disclosure. *The British Accounting Review*, 47, 409-424.
- Lyon, T.P. and Shimshack, J.P. (2015). Environmental disclosure: evidence from Newsweek's Green Companies Rankings. *Business & Society*, 54(5), 632-675.
- Porter, M.E. and van der Linde, C. (1995). Green and competitive: Ending the stalemate. *Harvard Business Review*, 73(5), 120-134.
- Walley, N. and Whitehead, B. (1994). It's not easy being green. *Harvard Business Review*, May-June, 46-52.

# Licensing for Cooks and Bakers in the State of Florida

Garry Colpitts

College of Hospitality & Tourism Leadership  
University of South Florida Sarasota-Manatee, USA

## Abstract

This study is meant to bring about a thoughtful group discussion on the challenges to the food service industry as it relates to the handling and preparation of foods by cooks and bakers. The Center for Disease and Control (CDC) estimates that 1 in 6 Americans get sick from contaminated foods and beverages every year and that over three thousand will die (CDC, 2018). The American Culinary Federation is looking into the European Union, where they are taking the lead with licensing, which is becoming required more than ever (Santé, 2017). According to Chef Kinsella, CMC, CEC, AAC (2017). “I honestly believe that both the federal and state governments will require licensure in the near future. The rationale behind this is quite simple: The highest number of food poisoning incidents in the United States today is in foodservice establishments. The most effective way to curtail food contamination and ensure the preparation of healthy foods will be licensure.” The purpose of the study is to have an open discussion with hospitality professionals, culinary instructors, restaurant owners, dietary specialist, and hospitality students. Discuss the pros and cons of licensing for foodservice workers and what might be the impact on the foodservice industry in general.

**Keywords:** licensing, Florida, policy, cooks

## References

- Center for Disease and Control. (2018, April 04). Food Safety. Retrieved from <https://www.cdc.gov/foodsafety/cdc-and-food-safety.html>
- Kinsella, J. (2017, January 20). Should a chef need a license to cook? *ISante*, Retrieved April 25<sup>th</sup>, 2018, from [://www.isantemagazine.com/article/should-chef-need-license-cook](http://www.isantemagazine.com/article/should-chef-need-license-cook)



## How Do Millennials Select Restaurants?

Bendegul Okumus, Sevil Sonmez, and Ahmet B. Ozturk

Rosen College of Hospitality Management  
University of Central Florida, USA

### Abstract

The study investigates how Millennials' select restaurants when they eat out. Based on an in-depth literature review, semi-structured interviews were developed and data was collected via face to face semi-structured interviews with 50 Millennials. Interviews took from 10-45 minutes, were tape recorded and transcribed. The findings suggest that millennials' demographic characteristics such as gender and education influence their food choices. Millennials often prefer quick, convenient, and inexpensive food, close restaurants to their home or workplaces. Interestingly, they claimed to pay attention to healthy eating but their reported eating practices and restaurant selection options did not fully support their claims. The research findings offer interesting theoretical and practical implications.

**Keywords:** millennials, eating behavior, restaurant selection, qualitative research

# Chinese Cruise Customers Loyalty: The Impact of Customer Participation and Service Personal Values

Hui Wu<sup>1</sup>, Xiaoxiao Lv<sup>2</sup>, Muhittin Cavusoglu<sup>3</sup>, and Cihan Cobanoglu<sup>4</sup>

<sup>1</sup>College of Business Administration  
Hunan University

<sup>2</sup>Zhengzhou Haimanshi Medical Devices Co., Ltd., China

<sup>3</sup>College of Education  
University of South Florida, USA

<sup>4</sup>College of Hospitality & Tourism Leadership  
University of South Florida Sarasota-Manatee, USA

## Abstract

The cruise industry in China is undergoing rapidly development. Nevertheless, current researches are just in the initial stage. Therefore, it becomes critical and urgent to discuss in depth how to enhance the recognition and satisfaction and loyalty of Chinese tourists. Based on the perspective of service-dominant logic, the purpose of this study was to shed light on a better examining of the formation process of loyalty behavior of Chinese cruise tourists. The empirical results indicated that customer participation (CP) positively influenced service personal values (SPV), customer satisfaction (CS) and as well as customer loyalty (CL). SPV have significant and positive impact on CS as well. Moreover, the study also finds that collectivism has a strong positive effect on CP. Price sensitivity negatively moderates the relationship among CP, CPV, CS, and CL. Finally, practical contributions to the Chinese cruise industry and theoretical contributions to the literature were discussed. Overall, findings from this study offer constructive suggestions for cruise companies in China to upgrade their competitiveness.

**Keywords:** cruise tourists; customer participation; service personal values; customer loyalty; price sensitivity

# 'Fake News' in the Travel and Tourism Domain: An Investigation of the Phenomenon and Challenges for the Industry

Giancarlo Fedeli

Moffat Centre for Travel and Tourism Business Development  
Glasgow Caledonian University, United Kingdom

## Abstract

The proposed conceptual paper considers the phenomenon of 'fake news' in the context of travel and tourism. 'Fake news' are described as fictitious information which is produced to appear as credible evidence, therefore designed with a deceiving purpose (Brennen, 2017). The term has gained momentum and greater attention in the recent years due to diffusion of Information and Communication Technologies, digital media and the popularity of numerous social platforms reaching out and connecting people across the globe. The power of 'fake news' has demonstrated to have a vast impact and implications on public matters. An example often cited is the latest U.S. political elections held in 2016, where the effects of fabricated stories played a primary role in the outcome of the elections, with false reports and information seriously challenging the more traditional and recognized media sources (Allcott & Gentzkow, 2017).

The term 'fake news' has been associated to: news satire and parody, manipulation, fabrication, advertising, and propaganda (Tandoc, Lim, & Ling, 2018). As the term appears not to be universally accepted, Allcott and Gentzkow (2017) further include: intentional reporting mistakes; rumors that do not originate from a particular news article; conspiracy theories; satire that is unlikely to be misinterpreted as genuine; false statements by politicians; and reports that are biased or misleading although not absolutely false. This evidence clearly shows the discussion around the term and its use is unquestionably dynamic and represents a controversial topic.

The tourism sector cannot be ignored amidst this social global phenomenon, being tourism a sector highly dependent on information and an incessant originator of new information, shared and consumed by millions of people worldwide (Werthner, Koo, Gretzel, & Lamsfus, 2015). In the wake of the latest facts from various contexts, 'fake news' has the potential, for instance, to impact opinions, expectations and behavior of tourism consumers; the manipulation of information could also be used -to different extents - to the benefit or detriment of tourism operators or destinations.

The paper briefly reviews the literature on the topic of 'fake news'. At the time of conducting the literature review, academic sources were available in the areas of politics, journalism, sociology and computer science. This supports the need for specific research applied to the tourism field, hence originated the scope of this study. The review of practical evidence also leads to identify and include examples of 'fake news' in the travel and tourism industry. The research undertaken finally leads to categorize four areas of importance: a) Ethical considerations; b) Marketing of tourism organisations; c) Impact on tourist's perception and behavior and; d) Issues on security and regulation of 'fake news' in travel and tourism.

The proposed paper represents the first piece of research attempting to better understand the phenomenon of 'fake news' in the travel and tourism context. Therefore its main aim is exploratory in nature and it attempts to raise consideration and encourage discussion about several conceivable

implications related to users (visitors and tourists), tourism organisations and marketers, on both theoretical and practical aspects around the diffusion of the phenomenon at the center of this abstract. The paper gives academics and practitioners a foundation for envisioning the current and future state of 'fake news' and the challenges in the travel and tourism industry.

**Keywords:** 'fake news', tourism marketing, e-tourism ethics, on-line security and regulation

## References

- Allcott, H., & Gentzkow, M. (2017). Social Media and Fake News in the 2016 Election. *Journal of Economic Perspectives*, 31(2), 211–236.
- Brennen, B. (2017). Making Sense of Lies, Deceptive Propaganda, and Fake News. *Journal of Media Ethics*, 32(3), 179–181
- Tandoc, E. C., Lim, Z. W., & Ling, R. (2018). Defining "Fake News." *Digital Journalism*, 6(2), 137–153
- Werthner, H., Koo, C., Gretzel, U., & Lamsfus, C. (2015). Special issue on Smart Tourism Systems: Convergence of information technologies, business models, and experiences. *Computers in Human Behavior*, 50, 556–557

# **Cruise Ships' Safety Measures and Their Influence on Passengers' Sense of Security and Purchase Intention**

Shadi Bahattab, Shiang-Lih Chen McCain, Jeff Lolli, and Joy Dickerson

Center for Hospitality Management  
Widener University, United States

## **Abstract**

The cruise industry is one of the smallest industries and one of the fastest growing sectors, achieving more than 7.2% growth per year since 1980 and more than 100% in 2011. Even though the industry has recorded significant growth, security and safety issues are a major threat to the industry's future growth and profitability (Baker, 2013). According to Lipcon, Margulies, Alsina and Winkleman (2016), 448 major cruise ship accidents were reported from 2005-2016. Recent tragic accidents on cruise lines have raised public concern about cruise line safety measurements. The purpose of this study was to examine how cruise ships' safety measures influence passengers' sense of security and purchase decision. The three major safety risks in the Cruise Ship Industry are 1) The risk of an external/internal attack on passengers and crew, 2) The risk of on Water Technical Malfunctions, Accidents, and Fires, and 3) The risk of Having Medical/ Health Issues among Passengers and Crew. The results indicated that: 1) cruise ships' safety measures influenced passengers' sense of security, 2) cruise ships' safety measures will influence passengers' purchase decision, and 3) passengers' sense of security will influence passengers' purchase decision.

**Keywords:** cruise, safety, passenger, security, purchase, decision

## **References**

- Baker, D. (2013). Cruise passengers' perceptions of safety and security while cruising the western Caribbean. Brazil: Revista Rosa dos Ventos.
- Lipcon, Margulies, Alsina & Winkleman Law Firm. (2016). Passengers and crew injured on ships in maritime claims worldwide. P.A, Retrieved from <http://www.lipcon.com/blog/a-maritime-lawyer-infographic/>

# **An Investigation of the Relationship Between Noise Level and Customer Satisfaction in the Restaurant Industry**

Tak Ming Yeung, Shiang-Lih Chen McCain, and Jeff Lolli

The Center for Hospitality Management  
Widener University, United States

## **Abstract**

Controlling noise level in restaurant settings becomes particularly important in today's environment. Unpleasant sounds in restaurant settings erode customer satisfaction and the complaints about noise level in restaurants have been accelerating. According to Zagat's 2010 America's Top Restaurants Survey, noise level ranked number two in customer complaints. However, in 2014, the noise level complaints became the top complaint in Zagat's 2014 America's Top Restaurants Survey (Zagat, 2014). Thus, the purpose of this study was to investigate the relationship between soundscape noise level and customer satisfaction in a restaurant setting. Soundscape refers to background sounds, physical sounds, and situational sounds in a restaurant setting (Hodgson, Steininger, & Razavi, 2007). This study showed background and physical sounds do not influence customer satisfaction.; however, situational sounds do influence customer satisfaction.

**Keywords:** soundscape, customer, satisfaction, restaurant, setting

## **References**

- Hodgson, M., Steininger, G., & Razavi, Z. (2007). Measurement and prediction of speech and noise levels and the Lombard effect in eating establishments. *The Journal of the Acoustical Society of America*, 121(4), 2023-2033. doi:10.1121/1.2535571
- Zagat, (2014), 20 Top-Rated Restaurants Across America. Retrieved from <https://www.zagat.com/b/americas-tops-20-top-rated-u.s.-restaurants>

# Are Corruption and Insurgency Nemesis of Tourism Development? Evidence From Nigeria

Uju Violet Alola<sup>1</sup>, Turgay Avci<sup>2</sup>, Ali Ozturen<sup>1</sup>, and Andrew Adewale Alola<sup>2</sup>

<sup>1</sup>Faculty of Tourism,  
Eastern Mediterranean University, North Cyprus  
<sup>2</sup>Department of Economics,  
Eastern Mediterranean University, North Cyprus

## Abstract

The news media suddenly became awash with breaking news headline. Coincidentally on 22nd February 2018, another set of ‘unspecified’ numbers of young schoolgirls were reportedly kidnapped by unnamed insurgent group(s). Also, by the end of the day, the Transparent International (TI) released its report (Corruption Perception Index-CPI) with Nigeria lowly placed at 148th of the 180 countries examined. In view of this, we investigate the joint significant impact of three different corruption indices and insurgency on tourism in Nigeria. A monthly data spanning 2005M01 to 2016M12 is employed. Using an ARDL econometric approach and controlling for inflation, the model significantly adjusts with a speed of 1.28% to long-run equilibrium. Both the social protection and quality of public administration indices showed long-run positive significant evidence of tourism receipts while the reverse is the case for fiscal policy rating. Similarly, insurgency exhibits a long-run significantly negative impact on the tourist receipts which translates to the performance of the industry. These indicators aggregate the performance and sustainability of tourism destinations. As a policy implementation pathway, Nigeria government and security stakeholders should rejig their counter-insurgency efforts to attain the country’s goal of enhancing a buoyant and sustainable tourism industry.

**Keywords:** tourism performance; corruption; insurgency; sustainable tourism destination; Nigeria; ARDL model approach.

## Reference

Pesaran, M. H., & Shin, Y. (1998). An autoregressive distributed-lag (ARDL) modelling approach to cointegration analysis. *Econometric Society Monographs*, 31, 371-413.

# Hotel Comment Card Reviews: A Model Proposal for Predicting Aspect Rating

Abdullah Tanrısevdi<sup>1</sup>, Gözde Öztürk<sup>1</sup>, and Ahmet Cumhuri Öztürk<sup>2</sup>

<sup>1</sup> The College of Tourism Management  
Adnan Menderes University, Turkey

<sup>2</sup> Söke Vocational College  
Adnan Menderes University, Turkey

## Abstract

Today, with rapid developments in information and communication technologies, customer satisfaction and loyal customer concepts gain importance. The need for customer retention efforts with people increasingly demanding, more selective and more emotional satisfaction has led to the execution of customer-focused work by the accommodation enterprises. It is crucial for the hotel management to be in constant communication with customers to establish permanent relations with them and to personalize this communication for each customer, to be able to accurately determine the preferences of the customers, and to be able to provide value to the customer. The main point in the management of the customer relationship management is to analyze the information obtained as a result of mutual (individual) interaction with the customer; to develop appropriate product and marketing strategies in line with customer behaviors, habits, needs and preferences. To this end, enterprises are needed to better understand consumer expectations and how they have shifted from product-focused to consumer-focused in order to offer products / services that create added value. In order to be able to gain loyal customers by providing customer satisfaction, and keeping pace with rapidly increasing competition, tourism enterprises are looking for ways to successfully compete by using knowledge gathered from customers themselves. Collection of customer information provides opportunities for the organization to understand purchasing behaviors of customers and helps to provide the customer preferred products and services. In that context, customer comments that indicate their feelings and opinions about their experiences are still seen as important data for tourism operators.

Considering rapid development of social media and user generated comments on the Internet, enabling transmission of knowledge rapidly, is being utilized, and relative decrease in the traditional UGC applications in hospitality industry, it can be argued that the paper-based comment cards used in hotel operations can still be regarded as a valuable feedback source of big data that is useful for the hotel management. Comment cards are a common way of obtaining customer feedback. This relatively short pencil and paper-based questionnaires allow customers to complete and return them at their convenience. It is of great convenience and secure return options, for example, hotel guests can simply put it on the make-up desk after filling out or they may use drop box, placed in the hotel. This is also useful tool for hotel guests who do not want to provide feedback in person. Further, there is still questions with regard to whether they are real or fake. Hence, in this present study, the real comments that hotel management sure about they were being received by actual guests were used.

The paper-based comment card is widely utilized and considered to be an effective feedback tool used by hotel management to understand customer expectations. Tourism enterprises use customer comment cards developed in their own organization to access desired data, including the feelings



and thoughts of the customers. Yet, to make customer feedback useful for hotels, comment cards must be properly designed, implemented, and analyzed. Customer comment cards used for measuring the customer satisfaction may differ in the types of questions they contain. Even if hotels use different design of comment cards, a common feature of many comment cards include an overall rating section which allows customer to generally evaluate an organization by using a predefined aspect rating section. The overall rating, however, does not contain any information about the customer's view of a specific feature of a service or product, and also employs predefined aspect ratings that limit the customer to specific features. In many cases, rather than directly considering the rating of a review, the content of the review gets the foreground. In light of this weakness, this paper proposes a novel aspect rating prediction technique to assign ratings to each comment card review. Sentiment analysis methods can be applied for such a case.

Automatically identifying and analyzing subjective information from natural language texts is called sentiment analysis, or opinion mining. The goal of sentiment analysis is to detect opinion, identify the sentiments people express by classifying the contextual polarity of a given text. The polarity can be positive, negative or neutral. In general, sentiment analyses are examined at three levels: document, sentence and aspect. In document level classification, it is possible to reveal the positive or negative feeling that dominates the whole of the document; in sentence-level, analysis can show positive, negative and neutral feeling in each of the sentences. In aspect level, directly focusing on the opinion itself is possible. In this level of analysis, the goal is to discover the feelings and or properties of the entities. If in a text document which contains positive opinion about an entity, it can be argued that whole properties of this entity have positive sentiment. In this study, we considered aspect level because we need to find out all aspects of the entity and whether the perception of each aspect positive or negative.

The sentiment analysis techniques can be used to analyze the overall rating of a given review (Asghar, 2016; Gupta et al.,2010; Martin, 2017), however, supervised learning was used in all these techniques. Supervised learning in sentiment analysis for rating prediction uses a training set, composed of previously defined rating and text pairs. The system is designed by the training set and the accuracy of the system is tested with this training set. However, some customer comment cards, because of the poor question designs, only allow for writing reviews and do not have rating fields to fill. In such case supervised learning-based sentiment analysis techniques are not useful for generating rating from the review. In the present study the authors propose a method for generating ratings for a given review by using the popular classifier Naïve Bayes. There have been many text classification techniques, proposed for supervised learning such as Support Vector Machines (SVM), K-Nearest Neighbor (KNN), Naïve Bayes and many others. In text categorization, Naïve Bayes classifier, which is a probabilistic classifier based on the Bayes theorem, is commonly-used. Despite its simplicity and strong assumptions, the Naïve Bayes classifier has been proven to work satisfactorily in many domains. In Naïve Bayes, the basic idea is to find the probabilities of categories given a text document by using the joint probabilities of words and categories. We, thus, decided to use a classification strategy Naïve Bayes (NB) because an advantage of Naïve Bayes is that it only requires a small amount of training data to estimate the parameters necessary for classification (Webb et al,2005; Cheng et al,2002). In current study, two different Naïve Bayes classifiers are used for implementing the predictions of both polarity and aspect of a given comment. The metrics recall and precision are measured to evaluate the accuracy of our classifiers. We also used k - fold cross validation technique while evaluating these two metrics. The proposed approach generates a rating using the polarity of comment and probabilities

of aspects in a given text. According to the probabilities of aspects, comments aspect rating values are attempted to determine and these aspect rating values are showed as star ratings.

Our proposed model consists of three modules, namely 'Prediction of Sentiment Polarity', 'Prediction of Aspect' and 'Aspect Rating Value Determination'. Generally, with our proposed system, when new hotel comment card review is given as input to the system, firstly pre-processing (removing numbers, punctuations, stop words etc.) period is performed. The comment which is preprocessed is given to the Naïve Bayes classifier which is trained with positive and negative labelling dataset for predicting sentiment polarity. If the comments' sentiment polarity is positive, the comment is given to the Naïve Bayes classifier which is trained with manual labelling fifteen different positive aspects, for predicting aspect. If the sentiment of the comment polarity is negative, the comment is given to the Naïve Bayes classifier which is trained with manual labelling fort-two different positive aspects, for predicting aspect. Most of the comments we used in this study have only one positive or negative aspect. Comment probability is calculated based upon all aspects. Highest aspect probability value is determined as comment aspect. Comments' sentiment polarity and aspect probability which is determined by Naïve Bayes classifier is used for aspect rating value determination. First, according to the sentiment polarity of the comment whether the rating is negative or positive is uncovered. Next, the aspect polarity of the comment probability is used for predicting the rating value. As the comments having aspect probability value between 0-100%, we proposed a scale for determine comments star rating. We made a pilot test to make sure the extent to which the system works or not by gathering raw data - about 2,000 paper-based reviews - from a large-scale hotel - located in Kuşadası, Turkey. XYZ hotel was selected because their response quality toward receiving comments was mentioned by hotel management as poor. We then obtained permission from the same hotel management in which we carried out pilot test, to analyze more paper-based written comments or complaints. We used three thousand and one hundred sixty-six comment cards for the analysis, collected by the hotel staff, in the period of June-September, 2016.

The contribution of this study is as follows; (1) be faster on customer feedback by making it possible to automatically summarize existing or new arrived customer comments for hotel management, (2) propose a new rating assignment mechanism for comments that have no ratings. The present study is of important insights since it combines traditional text approach and aspect rating prediction. Findings of the study can contribute to the hospitality literature, focusing on speed and accurate service recovery efforts. Moreover, although the use of comment cards in resort hotels has become limited, this study contributes to the emerging research field of traditional paper-based comment cards analysis. An important implication of our findings for hospitality industry is that hotel managements can improve service failures through quick and accurate feedback analysis. Hoteliers might use these analyses to reveal their errors in a short period based on the analysis of their guests' feedback. Thus, given the practical implications, hotel management might find this study useful in their management of guest feedback. As such, resort hoteliers can adopt our proposed model into their service processes. To do so, it is possible to integrate the proposed model into online customer review area on the web site of the hotel so that the web site can automatically response to the customers as if feedback is given from the hotel customer service (real hotel staff). In this respect, it is assumed that the proposed model is likely to fill this gap in the resort hotel industry.

There are several limitations associated with this study. First one is with regard to number of comment cards used for analysis. Hence, it will be more reliable for testing more reviews. Second, this study focused on one resort hotel, located in Kuşadası, Turkey. Thus, future research can use guest comments from various hotels, for example business hotels, or holiday villages. Third, data analysis was based on the reviews received within a timeframe of three months. So, it would be beneficial to get feedback dating back longer time periods. Fourth, the classification of customer comments according to the dominant aspect in customer reviews. In the future, this study can be extended based upon multi aspect comments.

**Keywords:** paper based comment card, Naïve Bayes, sentiment analysis, rating prediction

## References

- Akhtar N., Zubair N., Kumar A., & Ahmad T. (2017). Aspect based sentiment oriented summarization of hotel reviews. 7th International Conference on Advances in Computing & Communications, ICACC-2017, 115, 563-571.
- Asghar N. (2016). Yelp dataset challenge: review rating prediction. In: CoRR abs/1605.05362, URL: <http://arxiv.org/abs/1605.05362>
- Bartkus, K.R., & Howell, R.D. (2009). The quality of guest comment cards: an empirical study of U.S. lodging chains. *Journal of Travel Research*, 48(2), 162-176.
- Bell, J. B., Menguc B. & Stefani, S.L. (2004). When customers disappoint: a model of relational internal marketing and customer complaints. *Academy of Marketing Science*, 32(2): 112- 126.
- Cheng, J., Greiner, R., Kelly, J., Bell, D.A., & Liu, W. (2002). Learning bayesian networks from data: an information-theory based approach. *The Artificial Intelligence Journal*, 137, 43-90
- Gupta N., Fabrizio G. D., & Haffner P. (2010). Capturing the stars: predicting ratings for service and product reviews. In *Proceedings of the NAACL HLT 2010 Workshop on Semantic Search*, 36-43.
- Kotler, P. (1997). *Marketing management: analysis, planning, implementation, and control*. 9th Edition, Prentice Hall, Upper Saddle River.
- Liu B. (2012). *Sentiment analysis and opinion mining*. Morgan & Claypool Publishers.
- Martin, M. (2017). Predicting ratings of amazon reviews - techniques for imbalanced datasets. HEC-Ecole de gestion de l'ULg, Master en ingénieur de gestion, à finalité spécialisée en Supply Chain Management and Business Analytics, URL : <http://hdl.handle.net/2268.2/2707>
- Pang, B., Lee, L., & Vaithyanathan, S. (2002). Thumbs up?: sentiment classification using machine learning techniques. In *Proceedings of the ACL-02 conference on Empirical methods in natural language processing*, 10, 79-86
- Sigala, M. (2005). Integrating customer relationship management in hotel operations: managerial and operational implications. *International Journal of Hospitality Management*, 24, 391-413.
- Webb, G. I., Boughton, J., & Wang, Z. (2005). Not so naive bayes: aggregating one-dependence estimators. *Machine Learning*, 58(1), 5-24

# Why Do German Tourists Still Come Despite Security Problems? A Case Study in Kusadasi, Turkey

Büşra Hafçı and Abdullah Tanrısevdi

The College of Tourism Management  
Adnan Menderes University, Turkey

## Abstract

There have been several researches on the impact of terrorism on tourism decision-making process, crisis management in terrorism-related destinations; however, there is no emphasis on motivations of tourists who insistently visit destinations currently being affected by serious terrorist attacks. Although Turkey has been suffering from terrorist attacks for the last decades, especially in 2016, the country was still visited by many foreign tourists this year. More importantly, there were serious attacks on tourist groups by terrorists in Turkey in 2016. This research aims to find out (1) the underlying motivations related to German tourists to choose Turkey (2) the factors that encourage them in their vacation decision-making process, and thus it will be beneficial to tourism literature by providing empirical evidence to the conceptual decision-making process and practically help industry professionals.

The study focuses on German tourists visiting Turkey in 2016 since Germany is the top country sending tourists to Turkey this year. Although previous studies suggest that risky destinations are usually substituted by relatively safer ones (Sönmez & Graefe, 1998; Baker, 2014), there were about 26 million international tourists visiting Turkey. In the same period, 3,716,584 German tourists visited Turkey, which means Germany is the top country sending tourists to Turkey in 2016. Here, the unfortunate suicide bomb attack that directly aimed at German tourists in İstanbul, Turkey on 12 January 2016 must be especially emphasized because this sad event killed eleven tourists, and ten of those were German.

When all these come together, in the light of the related literature, Turkey should not have had tourists in 2016 since it might not be attributed as a safe country because of heavy and frequent terrorist attacks, so it was a risky tourism destination. There was another point that could discourage tourists to visit there: Turkey had frequent and random terrorist attacks, and according to Pizam and Fleischer (2002), frequency of terrorist acts has a larger impact on tourism demand compared to severity. Turkey has been suffering from terrorism for many years and 2016 was a bloody year for the country. However, there is a reality shown by statistics which indicates Turkey had 3,716,584 German tourists and at total 24,050,056 tourists in 2016 despite everything. Overall, it is important for a country whose economy heavily depends on tourism industry to find out the factors that encourage tourists to choose the destination although it seems risky and discovering the motivations and reasons of German tourists is the main aim of this study.

The sampling frame consisted of individuals who were German and who had either visited Turkey before or for the first time in 2016 since Germany was the top country sending tourists to Turkey that year. It was important to sample both tourists who either visited Turkey before or not because it was thought that there might be a difference in their risky decision according to destination knowledge beforehand.

A-multiple-step study method including in-depth interviews was used. In literature, it is possible to find out many studies focusing on the effects of terrorism or political turmoil to tourism demand (Henderson 2003; Pizam 1999; Sönmez 1998). However, a study that shed light on why some tourists still visit countries that have security problems inside could not be found. As a result, it was necessary to launch an in-depth interview to get the points to focus on deeply for an exploratory research (Johnson, 2002).

Since that was an exploratory research, there were not any available sample researches to guide the researchers, so it was necessary to create research questions by taking the related literature into consideration for the current study. To launch in-depth interviews, eight questions, mainly about price, travel experience, information search and source, and motivations of decision-makers, were prepared by the researchers and those questions were sent to three different domain experts in faculties to be able to increase the validity. After the feedback, the necessary modifications were made to the questions, and it was highly important to find the suitable time to start the field study, and 8 of March 2017 was decided as the start point since there was *International Tourism Bourse -ITB-* top tourism fair in the world, in Berlin, Germany. One of the authors went to Berlin to be able to initiate the field studies.

On the first day of Berlin visit, there was the opportunity to start an in-depth interview with a Turkish citizen who has lived in Germany for almost thirty years and has been working as a travel agent organizing cultural tours to Turkey. He was in his fifties and he was a true field expert to lead us during this exploratory process thanks to his great experiences in the mid of German and Turkish tourism industry. Another reason for him to be a perfect guide is the friendship between the author and the participant. Thus, the interview was held during a sincere dinner and it took about three hours. All the eight questions were asked, and the answers were both satisfying and supporting, which was important to increase the validity of the research questions. On 8 of March 2017, the second in-depth interview was held in Berlin with a German citizen who had been to Turkey eight times before. The participant was an engineer and he was 52 years old, and the interview took about an hour. He was eager to talk about his travel experience and decisions because he was a true Turkey- lover, as he uttered many times during the interview.

Since 8 of March 2017 was the beginning of *ITB International Tourism Bourse*, it was not difficult to find people suitable for the target group in the fair. During *ITB Berlin- 08-12 March 2017-* the fair was visited, and some small conversations were held to catch a glimpse from the people around, but, of course, these small conversations could not last long since people were not eager to attend a research while they were there to wander around for their dream holiday. Since that was not the first visit of the author to *ITB*, it was easy to observe that there were not as many people as the previous years to visit Turkish tourism hall. Another important point during the fair was to witness a propaganda which aimed to give people the message not to visit Turkey. After this incident, it was more important to talk to people who were still visiting the hall of Turkey.

After these two in-depth interviews and small conversations in Berlin, the researcher returned to Turkey, and the second step of the study started. At first, an in-depth interview with an English couple living in Kuşadası for many years was set. The aim was to make sure about the validity of the research questions and to see if there was something missing by comparing the answers of that family for two reasons (1) they were from a different nation and (2) they were permanent residents in Turkey. That interview took about an hour and the answers were really like the ones obtained

until that time, which meant the study was going in the right direction. It was now time to start a series of in-depth interviews.

A five-star hotel in Kuşadası which was an important location for German tourists was chosen to reach and set new interviews with target groups while they were on holiday in Turkey. This hotel was important for the study because they have a great number of German tourists- both repeaters and new comer guests- every year. Another important point was that the Guest Relations Manager of this hotel was volunteer to participate actively in the study because she had been working in the same hotel for almost 15 years, so she knew every guest very well, she could set timing between the researchers and target groups, and since she was born in Germany she spoke German as fluently as her native language. All these reasons made the Guest Relations Manager of the hotel – an industry professional, as well - a great moderator for the interviews to be held. Participants were selected by the manager according to the conditions of becoming eager.

Between 5 of June 2017 and 16 of August 2017, seven in-depth interviews with 32 tourists, twenty repeat guests and twelve new comers were achieved. The medium of instruction was German with the help of the bilingual moderator since it is believed that people can explain their ideas best in their native language. These interviews were held separately, and they were in the hotel to make the participants feel relaxed. The first interview in the hotel was held with a group of five repeat German tourists and after this interview, the necessity to modify the research questions for repeaters emerged. In the rest six interviews, the research questions were directed to the groups separately and differently by considering whether they were repeaters or new comers. Each interview took about 45-55 minutes. Apart from the last interview, all interviews were organized with German guests. The last interview was held with four tourists- two of them were Dutch and the other two were Belgian- since it was aimed to create a control group and see if the factors of this research could stand still. After all, the control interview did not release any surprising results. Since all the answers were more and more similar day by day, it was thought that the field study could come to the end.

After each in depth interview, the moderator and author took notes to summarize the key points in interviews since none of the participants let voice recording for safety reasons, which was another important signal showing their negative perception of Turkey in terms of safety. *‘I do not want to be recorded because I do not think that Turkey has intellectual freedom, I might be jailed for what I say so If you insist on recording, I will have to cease the meeting and leave here...’*, said a participant in group in-depth interviews. All the summaries and key points were collected to create content analysis of the study. Key words for the study were created in the light of the data obtained in the field by the authors and the related literature.

After analyzing the first two in-depth interviews held in Berlin and one interview with a couple in Kuşadası, eight main content-driven codes were created by different coders. In doing so, after the series of group in-depth interviews, a group of seven researchers in college was created and they worked on code development process together in the office, but each created code separately. This process took about two hours and surprisingly not much happened to the number of codes only two main new codes were added and agreed on.

At total, nine codes were created in two stages. In the first stage, coders defined the codes broadly whereas in the second stage codes were defined more specifically. Codes created were as risk

perception, family, price, social media, cost-value, unique values of destination, intercultural communication, hedonism and religion. However; the development of categories and themes in the light of created codes is still continuing. According to the preliminary results, it was necessary to classify the guests according to their visiting experience, which means whether it was their first visit to the destination or not. It is also thought that codes can be subdivided into two subcategories as *economic* and *non-economic*. It seems logical to incorporate economic reasons into a single category. Under this category; price, cost-value and all-inclusive seem to be appropriate. It is also possible to collect non-economic reasons in three categories: decision-making process (risk perception and family), information source (social media and intercultural communication), and experience (hedonism, religion and uniqueness of destination).

**Keywords:** crisis, security, turmoil, tourism

## References

- Arana, J. E., & León, C. J. (2008). The impact of terrorism on tourism demand. *Annals of Tourism Research*, 35(2), 299-315.
- Arch, E. C. (1993) Risk-taking: A Motivational Basis for Sex Differences. *Psychological Reports* 73(1):3-11.
- Baker, D. M. A. (2014). The effects of terrorism on the travel and tourism industry. *International Journal of Religious Tourism and Pilgrimage*, 2(1), 9.
- Cook, Jr., W. J. (1990) The Effect of Terrorism on Executives' Willingness to Travel Internationally. Unpublished doctoral dissertation, The City University of New York.
- Crenshaw, M. (1989) Terrorism and International Cooperation. Occasional paper series 11. New York: Institute for East-West Security Studies.
- Crompton, J. (1979). Motivation for pleasure vacation. *Annals of Tourism Research*. 6(4), 408-424.
- Crompton, J. L. (1992) Structure of Vacation Destination Choice Sets. *Annals of Tourism Research* 19:420-434.
- D'Amore, L. J., and T. E. Anuza(1986) International Terrorism: Implications and Challenge for Global Tourism. *Business Quarterly* (November):20-29.
- Dann, G. (1977). Anomie, ego-enhancement and tourism. *Annals of Tourism Research*, 4, 184-194.
- Edgell, St., D. L. (1990) International Tourism Policy. New York: Van Nostrand Reinhold.
- Enders, W., and T. Sandler (1991) Causality between Transnational Terrorism and Tourism: The Case of Spain. *Terrorism* 14:49-58.
- Enders, W., T. Sandler and G. F. Parise (1992) An Econometric Analysis of the Impact of Terrorism on Tourism. *Kyklos* 45: 53 1-554.
- Evans, J. R. and B. Berman (1992) *Marketing* (6th ed.). New York: MacMillan.
- Feridun, M. (2011). Impact of terrorism on tourism in Turkey: empirical evidence from Turkey. *Applied Economics*, 43(24), 3349-3354.
- Fodness, D. (1994). Measuring tourist motivation. *Annals of Tourism Research*, 21(3), 555-581.
- Goossens, C. (2000). Tourism information and pleasure motivation. *Annals of Tourism Research*, 27, 301-321.
- Gu, Z., and T. L. Martin (1992) Terrorism, Seasonality, and International Air Tourist Arrivals in Central Florida: An Empirical Analysis. *Journal of Travel and Tourism Marketing* 1:3- 15.
- Hall, C. M. and V. O'Sullivan (1996) Tourism, Political Stability and Violence In Tourism, Crime and International Security, Issues, A. Pizam and Y. Mansfeld, eds., pp. 105-121. New York: Wiley.
- Henderson, J. C. (2003). Terrorism and tourism: Managing the consequences of the Bali bombings. *Journal of Travel & Tourism Marketing*, 15(1), 41-58.
- Hurley, J. A. (1988) The Hotels of Rome: Meeting the Marketing Challenge of Terrorism. *The Cornell Quarterly* 29:71-79.
- Jamroz, U. & Uysal, M. (1994). Travel motivation variations of overseas German visitors. *Journal of International Consumer Marketing*, 6(3/4), 135-160
- Johnson, J. M. (2002). In-depth interviewing. *Handbook of interview research: Context and method*, 103-119.
- Karber, P. A. (1971) Terrorism as Social Protest. Unpublished paper.
- Lea, J. P. (1996) Tourism, Tealpolitik and Development in the South Pacific. In *Tourism, Crime and International Security Issues*, A. Pizam and Y. Mansfeld, eds., pp. 123-142. New York: Wiley.

- Mayo, E. J., & Jarvis, L. P. (1981). *The Psychology of Leisure Travel*. Boston: CBI Publishing, Inc.
- Mill, R., & Morrison, A. (1998). *The Tourism System: An Introductory Text* (3rd ed). Dubuque, Iowa: Dendall/Hunt Publishing Company.
- Nunkoo, R., Gursoy, D., & Ramkissoon, H. (2013). Developments in hospitality marketing and management: Social network analysis and research themes. *Journal of Hospitality Marketing & Management*, 22(3), 269-288.
- Pearce, P. L. & Caltabiano, M. (1983). Inferring Travel Motivation from travelers' experiences. *Journal of Travel Research*, 12(2), 16-20.
- Plog, S. C. (1974) Why Destination Areas Rise and Fall in Popularity. *The Cornell Quarterly* 14(9):55-58.
- Pizam, A., & Fleischer, A. (2002). Severity versus frequency of acts of terrorism: which has a larger impact on tourism demand?. *Journal of Travel Research*, 40(3), 337-339.
- Pizam, A., & Smith, G. (2000). Tourism and terrorism: A quantitative analysis of major terrorist acts and their impact on tourism destinations. *Tourism Economics*, 6(2), 123-138.
- Poland, J. M. (1988) *Understanding Terrorism*. Englewood Cliffs NJ: Prentice-Hall.
- Richter, L. K. (1983) *Tourism Politics and Political Science: A Case of Not So Benign Neglect*. *Annals of Tourism Research* 10:313-315.
- Richter, L. K. and W. L. Waugh, Jr. (1986) *Terrorism and Tourism as Logical Companions*. *Tourism Management* 7:230- 238.
- Roehl, W. S., and D. R. Fesenmaier (1992) *Risk Perceptions and Pleasure Travel: An Exploratory Analysis*. *Journal of Travel Research* 30: 17-26.
- Sandler, T. and H. E. Lapan (1988) *The Calculus of Dissent: An Analysis of Terrorists' Choice of Targets*. *Synthese* 76:244-261.
- Sönmez, S. F. (1998). Tourism, terrorism, and political instability. *Annals of Tourism Research*, 25(2), 416-456.
- Sonmez, S. F., and A. R. Graefe (1998) *International Vacation Decisions and Terrorism Risk*. *Annals of Tourism Research* 25(1):112-144.
- Sonmez, S. F., Y. Apostolopoulos, and P. Tarlow (1999) *Tourism in Crisis: Managing the Effects of Terrorism*. *Journal of Travel Research* 38: 13-18.
- Toman, J. (1991) *Developing an International Policy Against Terrorism*. In *International Terrorism: Policy Implications*, S. Flood, ed., pp. 111-128. Chicago: The University of Illinois at Chicago, Office of International Criminal Justice. Tremblay.
- TÜRSAB, (2016, November). *Tourism Statistics Report*, Date Accessed: 11.01.2017, [http://www.tursab.org.tr/dosya/15049/kasim\\_15049\\_5050753.pdf](http://www.tursab.org.tr/dosya/15049/kasim_15049_5050753.pdf)
- Tversky, A. and D. Kahneman (1981) *The Framing of Decisions and the Psychology of Choice*. *Science* 211:453-458.
- US Department of State 1996 *Patterns of Global Terrorism: (1995)*. Washington, DC: US Department of State.
- Uysal, M., & Jurovski, C. (1994). Testing the push and pull factors. *Annals of Tourism Research*, 21, 844-846.
- Wahab, S. (1996) *Tourism and Terrorism: Synthesis of the Problem with Emphasis on Egypt* In *Tourism, Crime and International Security Issues*, A. Pizam and Y. Mansfeld, eds., pp. 175-186. New York: Wiley.
- Weber, E. U., Hsee, C. K., & Sokolowska, J. (1998). What folklore tells us about risk and risk taking: Cross-cultural comparisons of American, German, and Chinese proverbs. *Organizational behavior and human decision processes*, 75(2), 170-186.
- Weimann, G., and C. Winn (1994) *The Theater of Terror: Mass Media and International Terrorism*. White Plains NY: Longman.

## Acknowledgements

We would like to express our sincere gratitude to Mr. Ali Özkan, a tourism professional who runs his own travel agency in Germany for contributing that much to our research with his knowledge and experience in the field.



# Photographs in the Field of Sustainability: Some Preliminary Findings

Lorenzo Gelmini

Department of Business Studies  
University of Eastern Piedmont, Italy

## Abstract

Sustainability Reporting is, according to the literature, the practice of measuring, disclosing, and being accountable to internal and external stakeholders for the company's ability to achieve sustainable development goals and manage impacts on society. Along this line, sustainability reporting includes environmental aspects (such as raw materials, energy, water, biodiversity, air, suppliers, products and services, and transportation) as well as social aspects (such as labor practices, human rights, customer health and safety, respect for privacy, bribery and corruption, public policy competition, pricing, and corporate citizenship). In this sense, one of the main important areas of research is constituted by the agriculture and food industry: agricultural sustainability is a growing concern for the general public, taking into account agriculture's considerable use of land, water, and other natural resources. According to Topp-Becker et al (2017), in effect, "in response to this concern, companies have started to publish sustainability reports to highlight sustainable practice"; however, the results of their survey in 2017 show that "sustainability reporting is limited among companies involved in the agri-food supply chain". At the same time, literature on Sustainability Reporting generally relies on narrative and quantitative analysis whilst it could be fruitful to adopt also methodologies which encompass and encapsulate visual mechanisms (see Jane Davison work, from 2007 on). Bringing together these two issues of research, the paper develops an analysis of the visual content of a leading producer of palm oil in Malaysia; the findings are important because they shed light on a under-developed industry (the agriculture) using an innovative mechanism (visual images).

**Keywords:** Barthes, sustainability accounting, visual mechanisms

## References

- Davison, J. (2007). Photographs and accountability: Cracking the codes of an NGO. *Accounting, Auditing & Accountability Journal*, 20(1), 133-158.
- Topp-Becker, J., & Davis, D. E. (2017). The role of sustainability reporting in the agri-food supply chain. *Journal of Agriculture and Environmental Sciences*, 7(1), 17-29.

# Peace Agreement Affecting Risk Perception and Travel Intention

Natalia Zapata Cuervo and Paula Florez-Gomez

Escuela Internacional de Ciencias Económicas y Administrativas  
Universidad de La Sabana, Colombia

## Abstract

Tourism Industry is one of the world's important economic activities due to its fastest growing elements in the global trade (Kim, Chen and Jan, 2006; Balaguer and Cantavella, 2002; Parrilla, Font and Nadal, 2007; Ishikawa and Fukushige, 2007). For some countries and destinations, tourism is an economic sector where growth and survival are dependent on (Brida, Monterubbianesi, and Zapata-Aguirre, 2011; Cole & Morgan, 2010). The internal situation, political instability and war that Colombia faced with guerrilla for more than 50 years, had a negative impact on the image of the country. Colombia was recognized as an unsafe destination and international travelers avoid it (Gómez, 2002; Ortiz, 2002). Which had have a big impact on the economy for many years, tourism industry just contributed around 2.75% of the country's GDP. The government signed the peace agreement with Fuerzas Armadas de Colombia, FARC, on November 2016 to improve the internal situation and the growth of the economy. It is expected that the signature of the peace agreement will have a positive impact on the tourism industry. Colombia has great opportunities to expand its tourism offerings, the country has many attractive sceneries and landscapes, diverse flora and fauna, weather diversity, wide outdoor activities, ecotourism. Researchers aim to understand the influence of peace agreement on the intention to visit Colombia, analyzing the impact of tourism information and destination image on intention to visit. It is expected that peace agreement will improve the selection of Colombia as a tourist destination for international travelers.

**Keywords:** peace agreement, risk perception, travel intention, Colombia

## References

- Balaguer, J., & Cantavella-Jorda, M. (2002). Tourism as a long-run economic growth factor: the Spanish case. *Applied economics*, 34(7), 877-884.
- Brida, J. G., Monterubbianesi, P. D., & Zapata-Aguirre, S. (2011). Impactos del turismo sobre el crecimiento económico y el desarrollo. El caso de los principales destinos turísticos de Colombia. *Pasos. Revista de Turismo y Patrimonio Cultural*, 9(2), 291-303.
- Cole, S., & Morgan, N. (Eds.). (2010). *Tourism and inequality: Problems and prospects*. CABI.
- Gómez, J. A. (2002). Tourism, Armed Conflict and Peace in Colombia: Betting on the Future. *Anuario Turismo y sociedad*, 1, 57-69.
- Ishikawa, N., & Fukushige, M. (2007). Impacts of tourism and fiscal expenditure to remote islands: the case of the Amami islands in Japan. *Applied Economics Letters*, 14(9), 661-666.
- Kim, H. J., Chen, M. H., & Jang, S. (2006). Tourism expansion and economic development: the case of Taiwan. *Tourism Management*, 27(5), 925-933.
- Ortiz, R. D. (2002). Insurgent strategies in the post-cold war: the case of the revolutionary armed forces of Colombia. *Studies in Conflict and Terrorism*, 25(2), 127-143.
- Parrilla, J. C., Font, A. R., & Nadal, J. R. (2007). Tourism and long-term growth a Spanish perspective. *Annals of tourism research*, 34(3), 709-726.

# *Human Resource Management*

# Assessing the Barriers to Effective Hospitality Internship in China

Caiwei Ma<sup>1</sup>, Po-Ju Chen<sup>2</sup>, Lianping Ren<sup>3</sup>, and Tingting Zhang<sup>2</sup>

<sup>1</sup>School of Economics & Business  
Shanghai Second Polytechnic University, China

<sup>3</sup>Institute for Tourism Studies, Macau  
Colina de Hongha, Macau

<sup>2</sup>Rosen College of Hospitality Management  
University of Central Florida, USA

## Abstract

China – as the fastest expanding hotel market in the world – is currently experiencing a serious labor shortage. Talent management and innovative human resource management to enhance retention are the urgent needs in the China market. Exploring collaboration barriers may allow both universities and hotels to develop sustainable internship programs. The purpose of this study was to identify the barriers which impede hospitality internship programs. A qualitative research design with projective technique was conducted to elicit the underlying three themes of barriers perceived by industry practitioners from China's Tier One cities. Three barriers impact on quality internship in China are environment, industry partnership, and coordination challenges. Practical and theoretical implications were addressed.

**Keywords:** hospitality internship; talent management; barriers management; human resources management; hospitality education

# The Measure of Emotional Intelligence in Leaders

R. Douglas Waldo, Madison Clark, and Robert B. Wharton

School of Business  
LeTourneau University, USA

## Abstract

The ability to be an effective leader consists of a set of traits and skills that have long been sought after as the key to success. Capability, knowledge, skills, and intelligence are common qualities in a leader, and while these are necessary, they may not be foundational. Much research has been done to gain a glimpse into what exactly makes a leader great, and over the years, many things have stood out as important factors such as confidence, inspiration, integrity, open-mindedness and many more like traits. However, even when a leader possesses these traits, there still seems to be an aspect that is missing from the mix; an intangible trait that Peter Salovey and John D. Mayer first referred to as Emotional Intelligence in 1990. They considered emotional intelligence to be "a form of social intelligence that involves the ability to monitor one's own and others' feelings and emotions, to discriminate among them, and to use this information to guide one's thinking and action." (Mayer & Salovey, 1990)

Emotional intelligence has become a key factor in the success and effectiveness of corporate leaders over the past few decades. Once it was seen that an increase in the qualities of emotional intelligence in a leader resulted in a direct increase in the team cooperation, team building, positivity in the corporate atmosphere, and overall success in leading others toward a compelling vision over a substantial period of time, the importance of emotional intelligence became clear. Great leaders are not simply one dimensional in quality and skill but also possess the added dimension of relational and emotional intelligence to their abilities, character and intelligence that puts them at the top of their field.

Daniel Goleman, the psychologist and Harvard graduate, to whom the majority of recent research on emotional intelligence is contributed, put it this way:

"The most effective leaders are all alike in one crucial way: they all have a high degree of what has come to be known as emotional intelligence. It's not that IQ and technical skills are irrelevant. They do matter, but...they are the entry-level requirements for executive positions. My research, along with other recent studies, clearly shows that emotional intelligence is the sine qua non of leadership. Without it, a person can have the best training in the world, an incisive, analytical mind, and an endless supply of smart ideas, but he still won't make a great leader" (Goleman, 1998).

After understanding the importance of emotional intelligence, the natural response would be to look for leaders that possess the traits and competencies that make up high emotional intelligence. However, in order to know these things, there has to be a standard, and a tool against which to measure and categorize the traits and competencies in an individual. There are two ways that emotional intelligence can be measured. The first trait-based tool we used to measure the innate traits that one possesses is the Schutte's Self-Report Emotional Intelligence Test (SSEIT) that was developed by the contribution and research of Dr. Nicola Schutte of New England University, and this measures the aspects of emotional intelligence that are a result of nature and are traits that a leader is born with. The second tool we used, the Leading Dimensions Profile (LDP) which was

developed by Douglas Waldo and associates at Leading Dimensions Consulting, LLC, looks into the competency-based model which explores the ways that traits can be built upon and improved through training and practice. Competencies can be learned, while traits are preexisting and inborn.

It is valuable to know if emotional intelligence be further developed and cultivated in an individual, or if it is merely a result of nature and thus developmentally limited, or if it is a fluid combination of the two. If the first is true, and if emotional intelligence can be learned and refined, a huge window of opportunity presents itself regarding self-development and awareness in leadership effectiveness. Anyone can become a great leader if we can develop a process through which to learn the traits and then a means of measuring the resulting increase.

A data group of 60 individuals were chosen to explore the possible correlations between trait based and competency based emotional intelligence factors in order to determine how the development of emotionally intelligent characteristics can occur in aspiring and existing leaders to further the effectiveness and success of the individual and their work environment. The data pool was required to complete two surveys: the SSEIT which measured competency-based emotional intelligence, and the LDP which measured trait-based factors and the degree to which each trait existed in each individual.

This paper explores the relationship between emotional intelligence and the traits that are naturally present and those that are a result of learning, development and environmental factors. We are seeking to address the objective of improving leadership abilities and to explore the needed tools to develop rising leaders. The correlations that we are exploring between these two sets of data points could help further inform of the possibilities of self-improvement in the workplace. The more emotional intelligence is understood, the more opportunity will be had for leaders to be better equipped to face the issues that are present in the teams that make up the corporate atmospheres in which they lead.

**Keywords:** emotional intelligence, trait, competency, leadership, SSEIT, LDP, self-development

## **References**

Salovey, P., & Mayer, J. D. (1990). Emotional Intelligence. *Imagination, Cognition & Personality*, 9(3), 185-211.  
Goleman, D. (1998) What Makes a Great Leader. *Harv Bus Rev*. 1998 Nov-Dec;76(6):93-102.

# Workplace Violence: Awareness and Prevention

Suzanne Crampton

Seidman College of Business  
Grand Valley State University, United States

## Abstract

Acts of violence continue to increase in all areas of our lives. There are many forms of violence that employees, customers, and others who come into contact with an organization at a work site and even outside a workplace may be exposed to. Today, more than ever, the population has become even more aware of and oftentimes victims of behavior and actions that cause them harm, both physical and mental. Of course, workplaces come in all sizes and industries and may be profit or not-for-profit. Post offices and other governmental agencies, organizations in industries such as manufacturing, construction, mining, transportation, education, entertainment, food, and sports have all experienced violent workplace behavior—no occupation or industry is automatically exempt.

In various studies, diverse occupations have been reported as being dangerous. For example, in a 2016 article published in the *New England Journal of Medicine*, it was reported that the most dangerous profession to work in is healthcare where it's been reported that nearly 75% of workplace assaults occurred in a healthcare environment (Lebron, 2017). The National Institute for Occupational Safety and Health (NIOSH) in 2016 agreed that the greatest risk for nonfatal violence is among healthcare and social assistance workers, but NIOSH also reported that the risk for fatal violence is higher for workers in sales, protective services and transportation (NIOSH, 2017).

Not all incidents involve shootings but serious violent incidents have steadily been in the news. In an FBI report reviewing active shooter incidents between 2000 and 2013, the FBI data indicated that the largest number of active shooting incidents were in workplaces and other commercial buildings (43%), followed by educational facilities (22), open spaces (13), government buildings (11%), residences (5%), health care facilities (3%) and houses of worship (4%) (Reynolds, 2018). Every organization is someone's workplace, and it is obvious that any workplace and any type of worker may be potentially involved in a violent incident.

According to the U.S. Bureau of Labor Statistics, approximately two million American workers have reported they are victims of workplace violence each year (Lebron, 2017; National Safety Council, 2018). Unfortunately, this number has increased by a million in approximately the last two decades compared to a report in 1997 on the number of non-fatal workplace assaults annually (NIOSH, 1997). This number is also likely much higher today given that non-fatal injuries and illnesses have been found to be underreported (Lebron, 2017). Workers may not report an assault out of fear or for a number of other reasons, and in some cases employers may discourage the reporting of incidents because of the resulting publicity. According to NIOSH, there are four categories of workplace violence: criminal intent, customer/client, worker-on-worker and personal relationship, which overwhelmingly targets women (National Safety Council, 2018).

Workplace violence is any situation that may increase in intensity and threaten the safety of any employee, have an impact on any employee's physical and/or psychological well-being, or cause

damage to company property (Minor, 1995; NIOSH, 1997). According to OSHA, this includes any act or threat of physical violence, harassment, intimidation, or other threatening disruptive behavior at a work site and can range from threats and verbal abuse to physical assaults and homicides (Lebron, 2017).

Much attention has been given to severe physical violence at work and several analyses have been conducted surrounding such well-known incidents as the U.S. Postal Service shooting in 1986, violence at Columbine High School in Colorado in 1999, the Virginia Tech shootings in 2007, the Fort Hood massacre in 2009, the assassination attempt on Congresswoman Gabrielle Giffords and the shooting of 18 others during that incident in 2011, and the Sandy Hook Elementary shooting in Newtown, CT in 2012. Many of the more recent violent incidents will no doubt also be similarly examined: The San Bernadino mass shooting in 2015, the San Francisco UPS Warehouse killings in 2017 along with the mass shootings in Las Vegas, NV and Orlando, FL and the First Baptist Church in Sutherland Springs, TX all in 2017, and more recently the mass shootings at Marjory Stoneman Douglas High School in Parkland, FL in 2018. These violent behaviors can create health and safety concerns and result in safety legislation violations and criminal charges. It has been reported that the rate of mass shootings in the U.S. has tripled since 2011, according to a study by researchers at the Harvard School of Public health and Northeastern University (Reynolds, 2018). However, it is not just mass shootings and death in the workplace that are concerns. Other forms of violence, assaults, and threats have also made going to work difficult. In addition to physical injuries, psychological violence is a major form of trauma and includes many long-term harmful behaviors and verbal abuse that have become commonplace in our lives, both within and outside the workplace. Psychological violence can also result in a high degree of emotional damage as victims are subjected to verbal abuse, various forms of bullying, intimidation, coercive and other rude behaviors.

As previously noted, every organization is a workplace for someone and every organization needs to address workplace violence; the costs are high. Companies and employees suffer many losses due to workplace violence, such as low productivity, sick days, impaired judgment, low morale, etc. Of course, there are also legal reasons beyond the costs involved that organizations need to address violence. The Occupational Safety and Health Act (OSHA) has a General Duty clause that requires employers to provide a safe and healthy workplace for all workers who are covered by the Occupational Safety and Health Act. Reasonable actions must be taken to diminish or prevent violence and other hazards in the workplace. As reported by Stone and Hayes (1995), a workplace violence policy defines an organization's position and practices as they relate to any behavior manifested at work by one or more individuals against others that threatens, or attempts or actually inflicts physical harm. A company should conduct a self-assessment to determine what type of policy is necessary. This may include conducting climate surveys concerning employees' opinions regarding issues relating to workplace violence. An effective policy should clearly define acceptable and unacceptable behaviors and should (1) set standards of expected behavior; (2) develop a mechanism for employees to report any problem situation; and (3) include procedures that supervisors and others should follow to prevent and respond to problem situations (Stone & Hayes, 1995). Creating emergency action plans, conducting training exercises with local law enforcement, adopting a zero-tolerance workplace violence policy, and training employees on not just the above but also on understanding warning signs are all examples of actions that need to be developed and implemented (National Safety Council, 2018). Effective programs should evolve



from the organization's basic policy regarding violence, intimidation, bullying, harassment and other unacceptable behaviors at work.

This paper will discuss the current state of workplace violence in its diverse forms along with steps employers can take to reduce their chances of experiencing workplace violence. Organizational cultures can become toxic and strategies are needed to modify and manage abusive behaviors. Policies and strategies will be discussed in this paper along with training and support programs necessary to reduce the effects of violent incidents.

**Keywords:** workplace, violence, management

## References

- Lebron, A. (2017, October 30). The latest on workplace violence statistics. RAVE Mobile Safety. Retrieved from <https://www.ravemobilesafety.com/blog/latest-workplace-violence-statistics>
- Minor, M. (1995). Preventing workplace violence. New York: Crisp Publications.
- National Safety Council. (2018). Is your workplace prone to violence? National Safety Council. Retrieved from <http://www.nsc.org/Measure/Pages/Workplace-Violence.aspx>
- NIOSH. (1997, June). NIOSH facts: Violence in the workplace, Document #705002. Retrieved from [https://servicelink.pinnacol.com/pinnacol\\_docs/lp/cdrom\\_web/safety/hazard/violence/violence%20in%20the%20workplace.htm](https://servicelink.pinnacol.com/pinnacol_docs/lp/cdrom_web/safety/hazard/violence/violence%20in%20the%20workplace.htm)
- NIOSH. (2017, April 10). Occupational violence. Centers for Disease Control and Prevention. Retrieved from <https://www.cdc.gov/niosh/topics/violence/default.html>
- Reynolds, A. (2018, February 15). Are mass shootings becoming more frequent? CATA Institute. Retrieved from <https://www.cato.org/blog/are-mass-shootings-becoming-more-frequent>
- Stone, R. A., & Hayes, R. (1995, Autumn). Developing policies addressing workplace violence. *Employment Relations Today*, 22(3), 25-38.

# The Relationship Between Perceived Organizational Support, Organizational Commitment, and Job Satisfaction

Christine Bellido<sup>1</sup>, Sonya Bosanko<sup>1</sup>, Laurie Burcaw<sup>1</sup>, Kelly De Freitas<sup>1</sup>, William Paczkowski<sup>2</sup>,  
and Russell Clayton<sup>1</sup>

<sup>1</sup>Donald R. Tapia School of Business  
Saint Leo University, USA

<sup>2</sup>Palm Beach State College, USA

## Abstract

This study examined the relationships between perceived organizational support, organizational commitment, and job satisfaction. Previous research findings substantiated a strong positive relationship between perceived organizational support and organizational commitment, as well as perceived organizational support and job satisfaction (i.e., Ahmed, Nawaz, Ali, & Islam, 2015; Bogler & Nir, 2012; Byung & Maqbul, 2003; Rhoades & Eisenberger, 2002; Wnuk, 2017). However, studies in these areas are often limited by samples that target specific sectors and industries. This study sought to expand the research through the utilization of a more generalized sample of the population to determine if employees in the United States exhibited similar relationships between perceived organizational support, organizational commitment, and job satisfaction.

When employees perceived that their organization supported them, it provided an important advantage for the business (Riggle, Edmondson, & Hasen, 2009). This support was crucial when considering the dynamics of the company's relationship to their workers, who are viewed as a vital resource needed for success (Riggle et al., 2009). Perceived organizational support has been viewed as an exchanged relationship, which has applied the rule of reciprocity that obligated the person to a reciprocity norm. This norm returned the favorable treatment of support and care by the other party, thus leading to potential beneficial outcomes for both parties (Gouldner, 1960; Rhoades & Eisenberger, 2002). Congruent with organizational support theory, other social exchange theories, such as the goal-setting theory and the expectancy theory, have been shown to produce mutually beneficial outcomes for the organization and the employee (Campbell, Perry, Maertz, Allen, & Griffeth, 2013; Maertz, Griffeth, Campbell, & Allen, 2007; Rhoades, Eisenberger, & Armeli, 2001; Shore & Wayne, 1993; Wayne, Shore, & Liden, 1997).

Organizational commitment is the relative strength that an individual identifies within an organization. Organizational commitment is developed through a perceived responsibility to help the organization achieve its objective and is influenced by positive norms of reciprocity (Blau, 1964; Cropanzano & Mitchell, 2005; Gouldner, 1960). Organizational commitment that has been manifested in enhanced service delivery has also been shown to have a direct relationship to achieving perceived organizational support (Vijay & Michael, 2007). Motivational and attitudinal constructs of organizational commitment have revealed correlations between an employee's commitment to the organization and the employee's behavioral acts within the organization (Byung & Maqbul, 2003).

According to Robbins & Judge (2009, p. 65) job satisfaction, was defined as "a positive feeling about one's job resulting from an evaluation of its characteristics." Job satisfaction, as it relates to

perceived organizational support, resulted in the feelings that occur when an employee evaluated the characteristics of his or her job (Newman, Nielson, Smyth, Hooke, 2015). Studies suggested that increased job satisfaction led to higher organizational commitment and, therefore, improved organizational success (Oshagbemi, 1997). Bogler and Nir (2012) examined the importance of perceived organizational support to job satisfaction among teachers and found that perceived organizational support had a significant influence on both intrinsic and extrinsic elements of job satisfaction (Bogler & Nir, 2012). Similar studies have indicated that emotional, behavioral, and cognitive components of job satisfaction had a significant relationship with perceived organizational support (Wrunk, 2017; Newman et al., 2015).

The current study contained data that utilized the online survey program SurveyMonkey.com, which obtained the sample panel of participants and administered the survey. The criteria to participate in the study included 1) subjects who were required to be older than 18 years of age, and 2) subjects who were required to be familiar with the use of internet technology. Of the 581 surveys collected, 577 were determined to be unusable after data cleaning removed cases with missing demographic data (age and gender). Most subjects were male (67.8 percent), with a mean age of 43 years old. The majority of the subjects tended to have some form of college education (56.8%), worked an average of 39.5 hours per week, and had been employed by their organization for an average of ten years

A simple regression analysis was conducted in SPSS and affirmed perceived organizational support was a significant positive predictor of both organizational commitment and job satisfaction when utilizing a broad sample base. These findings suggested that as the levels of perceived organizational support increased, the levels that an employee was satisfied with their job and their commitment to the organization also increased. The findings implied an organization's favorable treatment of employees resulted in beneficial outcomes for the organization that may have included an employee's obligation to assist the organization in achieving its objectives, increased concern for the organization's welfare, retention of employees, and increased productivity (Rhoades & Eisenberger, 2002; Wnuk, 2017). These results strengthened previous research on the positive relationship between perceived organizational support, organizational commitment, and job satisfaction (e.g., Ahmed et al., 2015; Wnuk, 2017).

This study was limited by problems that are inherent of survey data, including response biases and social desirability biases (Klazema, 2014). Since the survey data capture a single point in time, it may not hold true for a long period, resulting in the limited generality of findings (Leedy & Ormrod, 2016). The single question item used to measure job satisfaction may have limited the study findings by not providing a 'balanced scorecard' measure of several dimensions of a construct (Dugdale & Jones, 1997). Future research may want to consider different job facets, such as those described in the Job Descriptive Index (Smith Kendall, & Hulin, 1969).

Subjects were required to use SurveyMonkey.com, thus limiting the population of interest to those who are familiar with internet technology and the survey website. It may be informative for future research to examine the relationships between perceived organizational support, organizational commitment, and job satisfaction across a variety of communication technologies. Areas for future research may also include areas that reach beyond social exchange theories to cross-cultural differences. This area of research could be beneficial in understanding the relationships between perceived organizational support, organizational commitment, and job satisfaction. Differences in

power distance, as well as a short-term and long-term orientation at the organizational level, may also shed light on variables that influence perceived organizational support, organizational commitment, and job satisfaction.

**Keywords:** expectancy, exchange; reciprocity

## References

- Ahmed, I., Nawaz, M., Ali, G., & Islam, T. (2015). Perceived organizational support and its outcomes. *Management Research Review*, 38(6), 627-639.
- Blau, P. M. (1964). *Exchange and power in social life*. New York: Wiley.
- Bogler, R., & Nir, A. E. (2012). The importance of teachers' perceived organizational support to job satisfaction. *Journal of Educational Administration*, 50(3), 287-306.
- Byung, H. L., & Maqbul, J. (2003). An empirical study of organizational commitment: A multi-level approach. *Institute of Applied and Behavioral Management Quarterly*, 177-192.
- Campbell, N., Perry, S., Maertz, C., Allen, D., & Griffeth, R. (2013). All you need is ... resources: The effects of justice and support on burnout and turnover. *Human Relations -New York-*, 66(6), 759-782.
- Cropanzano, R., & Mitchell, M. S. (2005). Social exchange theory: An interdisciplinary review. *Journal of Management*, 31, 874-900.
- Dugdale, D., & Jones, C. (1997). Accounting for throughput: Techniques for performance measurement, decisions, and control. *Management Accounting*, 75(11), 52-56.
- Gouldner, A. W. (1960). The norm of reciprocity: A preliminary statement. *American Sociological Review*, 25, 161-178.
- Leedy, P. D., & Ormrod, J. E. (2016). *Practical research: Planning and design* (11th ed.). Upper Saddle River, N.J: Prentice Hall.
- Maertz, C.P., Griffeth, R.W., Campbell, N.S., & Allen, D.G. (2007). The effects of perceived organizational support and perceived supervisor support on employee turnover. *Journal of Organizational Behavior*, 28, 1059-1079.
- Newman, A., Nielsen, I., Smyth, R., & Hooke, A. (2015). Examining the relationship between workplace support and life satisfaction: The mediating role of job satisfaction. *Social Indicators Research*, 120(3), 769-781.
- Oshagbemi, T. (1997). Job satisfaction and dissatisfaction in higher education. *Education & Training*, 39(8), 354-359.
- Rhoades, L., & Eisenberger, R. (2002). Perceived organizational support: A review of the literature. *The Journal of Applied Psychology*, 87(4), 698-714.
- Rhoades, L., Eisenberger, R., & Armeli, S. (2001) Affective commitment to the organization: The contribution of perceived organizational support. *Journal of Applied Psychology* 86, 825-836.
- Riggle, R., Edmondson, D., & Hansen, J. (2009). A meta-analysis of the relationship between perceived organizational support and job outcomes: 20 years of research. *Journal of Business Research*, 62(10), 1027-1030.
- Robins, S.P. and Judge, T.A. (2009). *Organizational Behavior*. Prentice Hall, New Jersey.
- Shore, L. M., & Wayne, S. J. (1993) Commitment and employee behavior: Comparison of affective commitment and continuance commitment with perceived organizational support. *Journal of Applied Psychology* 78, 774-780.
- Smith, P. C., Kendall, L. M., & Hulin, C. L. (1969). *The measurement of satisfaction in work and retirement: A strategy for the study of attitudes*. Oxford, England: Rand McNally.
- Vijay, K., & Michael, J. M. (2007). A framework for the development of organizational commitment using action learning. Retrieved from <http://files.eric.ed.gov/fulltext/ED504566.pdf>.
- Wayne, S. J., Shore, L. M., & Liden, R. C. (1997) Perceived organizational support and leader-member exchange: A social exchange perspective. *Academy of Management Journal* 40, 82-111.
- Wrnuk, M. (2017). Organizational conditioning of job satisfaction. A model of job satisfaction. *Contemporary Economics*, 11(1), 31-44.

# *Innovation & Entrepreneurship*

# Using the 2030 Goals to Create Global Perspective When Teaching in Business and Innovation

Paul M. Lane<sup>1</sup> and Ryan Lafferty<sup>2</sup>

<sup>1</sup>Grand Valley State University, USA

<sup>2</sup>Fusion Innovation, USA

## Abstract

In February 2018, one of the authors attended the *Congresso in Havana, La Universidad y La Agenda 2030 para el Desarrollo Sostenible* where the UNESCO goals of 2030 were central to the conference. Presenter after presenter explained what their university or their country was doing to make headway on these goals. It was clear from the poster sessions, papers, panels, and in the Rectors' forums that the community of nations represented in the program were committed to learning and teaching about these goals in the classroom. This was a largely Hispanic and Portuguese conference with a few English speakers. The delegations were from all over the world, but largely, the Southern.

## *Social Product Innovation*

It was very motivating to the authors to find this support as it is used by the authors, co-professors in Design Thinking for Social Product Innovation (DTSPI) classes. In DTSPI, students are exposed to the 2030 objectives early on. The seventeen goals are referred to as buckets. The idea of the bucket is important as a bucket can contain lots of things. One of the most important parts of innovation is looking at a large problem and making it smaller and smaller until you finally get down to a single focus, or, a single person. You must make it small and actionable.

The students in DTSPI are first asked to explore a bucket. This is easily started as each bucket has background information within the UN website as well as basic information available for students online to begin the research process. Students often use this background information to investigate and then to help decide what bucket or goal they wish to pursue. If a student starts to investigate bucket number 6, clean water and sanitation, and chooses to focus on water, for example, they will quickly learn there are issues of quality and quantity to be considered.

Issues of quantity could be addressed by drilling wells if there is a strong subterranean aquifer of clean water running beneath or near the community. Another method is the collection and maintenance of water for places that have sufficient annual rainfall but must endure a long dry season like much of Central America. There are sails and other devices to collect water out of humid air when it cools as in when the air is going up a mountain or when it is cooled mechanically. Desalinization is another area of exploration to add more quantity. The point is to explore all areas and then narrow down over the duration of the course. It is discussed in more detail below.

To continue to explore one goal, to get an idea of the depth these buckets/goals have, students could look at the cleaning of water which could include cleaning water from a river or a drying lake bottom. Or, they could explore cleaning water of simple debris from a borehole in East Africa. Another option could be filtering the biological contaminants from a well near a farm in South America or using a bio sand filter. Similarly, cleaning water of biological contamination using clay-fired filters made with rice or coffee hulls could be explored. Use of individual filters such as

life straw, or some of the osmosis or pressure-based filters is another possible solution. The idea is to explore a variety of options.

The list could go on for pages dealing with arsenic, heavy metals, minute parts of plastic, drugs and other chemicals that may be present. The students quickly learn there is not one answer for everyone and that for each person or community the change may need to be incremental. The students soon begin to question their own actions in pouring things down the sink or contaminating so much water each time they flush a toilet, or with long showers and a great deal of soap. If the goal is to open minds to empower them to think in new ways, the UNESCO 2030 goals are a powerful tool.

The 2030 goals offer a unique way to explore the globe and various locations that are very different from your own. Students are asked to select a country from the base of the economic pyramid and to focus on the bucket or goal they have chosen in that country. They are then asked to do a video introduction of that goal in the country of choice using video footage or pictures they can find online to create a powerful short video of their own to look at the size of the gap.

After the video, they are asked to develop a panel that is familiar with the country and hopefully the goal or bucket that has been identified. The panel could include, but is not limited to, the following:

1. Residents of the country experiencing the problem.
2. Residents that have not experienced the problem.
3. Ex pats living in the country.
4. Residents of the country living in the United States.
5. International students from that country.
6. Experts in the problem area wherever they are located.
7. People located through dedicated social media groups for the country or for the identified goal.
8. People who have worked in the subject country as volunteers, business or government.

The goal in 2018 was to develop a panel of 25 of these people who would keep in touch through email, What's App, Skype, Facebook, LinkedIn, Group Chats, etc. While not all achieved this goal, many learned a lot about their country in reaching out to others to be on their panel. In some cases, they found that nationals did not think about the problem in the same way. In many cases, they found that working on this problem was not a major priority. In trying to communicate with potential panel members, most students were led to a deeper understanding of the country they were studying.



Figure 1. UNESCO 2030 goals

## Conclusion

The 2030 goals are serious business on a worldwide basis. They are also very stimulating to helping students think in new ways and from new perspectives. You can use them to broaden your students' experience of the globe, and certainly of markets and business opportunities. It has been an education learning from others. The Conference in 2018 in Havana was an eye opener. Hopefully these cases of how used in classes will help the reader think of ways to use the 2030 goals to enrich their students' experiences.

## References

- Business Model Canvass, <https://strategyzer.com/canvas/business-model-canvas>, accessed 29.4.2018
- Design Thinking Model, [https://www.google.com/search?q=design+thinking&client=firefox-b-1&source=lnms&tbm=isch&sa=X&ved=0ahUKEwiIx62Ty9\\_aAhXJzlkKHV1kDxkQ\\_AUICygC&biw=1280&bih=473#imgdii=U\\_bCtVrnBO2mSM:&imgcr=otuh1uwlbyWBDM:](https://www.google.com/search?q=design+thinking&client=firefox-b-1&source=lnms&tbm=isch&sa=X&ved=0ahUKEwiIx62Ty9_aAhXJzlkKHV1kDxkQ_AUICygC&biw=1280&bih=473#imgdii=U_bCtVrnBO2mSM:&imgcr=otuh1uwlbyWBDM:), accessed 29.4.2018
- Four billion people face severe water scarcity, new research finds , Guardian, <https://www.theguardian.com/environment/2016/feb/12/four-billion-people-face-severe-water-scarcity-new-research-finds>, accessed 29.042018
- Hoffman, Jascha, Lifestraw Saves Those Without Access to Clean Water, New York Times, September 26, 2011, <https://www.nytimes.com/2011/09/27/health/27straw.html>, accessed 29.04.2018
- UNESCO 2030 Goals [https://en.unesco.org/sites/default/files/sdgs\\_poster\\_new1.png](https://en.unesco.org/sites/default/files/sdgs_poster_new1.png), accessed 29.4.2018
- Universidad 2018, 11<sup>th</sup> Congreso Internacional de Educacion Superior, Programa Cientifico, organizado por El Ministerio de Educacion Superior y las universidades cubanas, 12-16th febrero 2018.*



# **Implementing Project Management Methodologies in Social Entrepreneurship Initiatives in Developing Nations: Methodology for Training SE Project Managers and Two Case Studies**

Raul Chavez

School of Business  
Southern Wesleyan University, USA

## **Abstract**

Social Entrepreneurship (SE) initiatives are the primary method of entry for community development projects in small towns and villages in developing nations. Several organizations and corporations in the United States of America have embraced Social Entrepreneurship in their Corporate Social Responsibility (CSR) plans. This study conducts a comprehensive review of best practices of SE incorporating Project Management techniques in order to develop a new SE methodology and instructional program. In addition to developing a SE Project Management Model (SEPM) and SE Project Management Instructional Plan (SEPMIP), this study presents two cases from real applications of Social Entrepreneurship abroad. The cases were carefully selected to reflect the natural challenges and significant impact of projects designed to solve an urgent need and, at the same time, empower the local community and a local entrepreneur –or leader- to develop and implement them in the future. The size and level of investment were not of consideration but the relevancy of such initiatives in the lives of a small community and how the project manager, from the sponsoring organization, can benefit from current Project Management knowledge and techniques to improve the effectiveness of the project and avoid scope creep or other common pitfalls of projects with limited resources.

The first case is World Hope, is a relief and development organization with outreach to 15 of the poorest countries in the world. The projects of community development include the following areas (World Hope International, 2018):

1. Clean water for those who thirst
2. Opportunity for entrepreneurs
3. Education to those without
4. Freedom to survivors of slavery
5. Food security for the hungry
6. Emergency aid to those in need
7. Health support for the sick and vulnerable

The second case is PacMoore, a food manufacturing company with a particularly unique mission of helping small communities abroad with projects of social impact (PacMoore, 2018). The second case differs from the first one in terms of organizational structure; however, it serves as a significant example of how Social Entrepreneurship (SE) is applied to smaller, although vital, projects abroad managed by the local population, and they become a priority to the entire firm.

Miller, Grimes, McMullen and Vogus (2012) define Social Entrepreneurship as “the process of employing market-based methods to solve social problems” (p.460). Furthermore, Santos (2012) sees SE as “the pursuit of sustainable solutions to neglected problems with positive externalities”

(p. 335). Dacin, Dacin & Matear (2010) even present 37 different definitions of Social Entrepreneurship from the existing literature in the academic world. It is clear that SE can have different interpretations, orientations, and applications in a variety of projects and initiatives. There are, however, methodologies that are more effective than others. Another unique aspect of a SE initiative is its purpose that can be translated as a particular type of Scope and Project Charter. Smith and Woodworth (2012) and Yiu, et al (2014) point out the altruistic nature of Social Entrepreneurship and their impact in communities around the world. With that particular orientation in mind, adjustments were made to traditional Project Management techniques and processes designed for social impact in small communities in developing nations.

Important contributions to the field of SE and Project Management are one of the main objectives of developing the SE Project Management Model (SEPMM) and SE Project Management Instructional Plan (SEPMIP) by adapting and incorporating the main Project Management Process Groups (PMI, 2017) such as: Initiating, Planning and Scheduling, Implementing, Controlling, and Closing.

Careful consideration was made to the curriculum design of the SE Project Management Instructional Plan (SEPMIP) based on best-practices in SE initiatives, Project Management methodologies, and the Author's experience managing and designing similar programs in a variety of instructional settings and universities in the USA and abroad. It incorporates the Author's experience living and managing projects in developing nations and studies that evaluate Project Management Training programs beyond instructional design, including its congruency and commitment towards the field of Project Management (Rooji, 2011). The program also shows how Project Management is traditionally taught as part of the larger field of Operations Management in most colleges and universities in the USA. This element is essential for the validation of the content of an intensive training program of this nature. Ravinder and Kollikkathara (2017), in a recent comprehensive study of the area of Project Management in colleges, found that its coverage under Operations Management is limited and outdated.

The SE Project Management Instructional Plan (SEPMIP) incorporates optimal course designs and platforms for virtual courses and interactions from and to the sponsoring agencies and the field project manager. It discusses current best-practices in creating projects of virtual courses including Marciniak's (2017) phases for the design of online courses and how to create a project for this type of instructional development. Instructional ideas are gathered from different cultures and countries in order to optimize the content, delivery, and overall design of the training program that will be offered to the field manager, the local entrepreneur, and how all the main stakeholders of the project will interact during the different stages. Stages follow the traditional Project Life Cycle from conceptualization to execution.

The Project Management Body of Knowledge (PMI, 2017) makes a clear distinction between a traditional manager or administrator and a Project Manager (PM) in these terms:

Typically, the functional manager focuses on providing management oversight for a functional or business unit. Operations managers are responsible for ensuring that business operations are efficient. The project manager is the person assigned by the performing organization to lead the team that is responsible for achieving the project objectives (p. 52).

The focus of the SEPMIP is to enhance the capabilities of the field Project Manager and assist the final owner, or local entrepreneur, to lead and improve the SE initiative in order to be self-sustainable and successful. The SE Project Management Model (SEPM), on the other hand, covers the structural aspects of the project itself and presents specific recommendations on how to assess the success and Project Value of the SE initiatives. Also, it lists methods to monitor the project and create simple forms of reporting to the sponsoring agencies or firms for further assistance in the future, debriefing, and Project Learning. Furthermore, the SEPM and the SEPMIP will serve as valuable tools for teaching Project Management in Operations Management courses and other business training in the USA and abroad. There is a clear need to bring innovative teaching techniques in a virtual course design for the dissemination and understanding of essential Social Entrepreneurship structures and Project Management techniques. The field of Social Entrepreneurship will benefit from the interaction with other disciplines closely related to Project Management such as: Risk Management and Assessment, Quality Assurance, Engineering Economics, and Change Management.

**Keywords:** project management, social entrepreneurship, community development, project management education, project management skills, corporate social responsibility.

## References

- Marciniak, R. (2017). Propuesta metodológica para el diseño del proyecto de curso virtual: aplicación piloto. (Spanish). *Apertura: Revista De Innovación Educativa*, 9(2), 74-95. doi:10.18381/Ap.v9n2.991
- Miller, T.L., Grimes, M.G., McMullen, J.S., & Vogus, T.J. (2012). Venturing for others with heart and head: How compassion encourages social entrepreneurship. *Academy Of Management Review*, 37(4), 616-640. doi:10.5465/amr.2010.0456
- PacMoore (2018). Retrieved: <https://www.pacmoore.com/>
- Project Management Institute (2017). *A guide to the Project Management Body of Knowledge (6<sup>th</sup> edition)*. Chicago, IL: PMI GLOBAL STANDARD Publication.
- Ravinder, H., Kollikkathara, N. (2017). Project Management in Operations Management Textbooks: Closing the Gap. *Journal of the Academy of Business Education*, 18, 307-324.
- Santos, F. M. (2012). A positive theory of social entrepreneurship. *Journal of Business Ethics*, 111(3), 335-351.
- Smith, I. & Woodworth, W. (2012). Developing Social Entrepreneurs and Social Innovators. *Academy of Management Learning & Education*, 11 (3), 390-407
- Williams van Rooji, S. (2011). Instructional design and project management: complementary or divergent? *Educational Technology & Research*, 59 (1), 139-158
- World Hope International (2018). About Us. Retrieved: <https://www.worldhope.org/about-us/mission>
- Yiu, D., Wan, W., Ng, F., Chen, X., & Su, J. (2014). Sentimental Drivers of Social Entrepreneurship: A Study of China's Guangcai (Glorious) Program. *Management & Organizational Review*. 10 (1), 55-80.

# *International Trade & Management*

# **Business Relations in the Global Economy “What is Good Corporate Citizenship?”**

Ernest E. Pegram

Department of Business Administration  
Averett University, United States of America

## **Abstract**

The purpose of this research is to examine business relations in the global economy with the objective to understand better what constitutes good corporate citizenship. The evolution of corporate social responsibility has changed how businesses manage corporate governance. Factors that define and measure whether businesses are operating successfully in the global economy as good corporate citizens are unclear. Each year, dozens of articles are published and numerous prizes are awarded for corporate social responsibility, however, there exist no agreed upon definition of good corporate citizenship (Locke, 2003). This research focuses on organizational design elements that constitute corporate social responsibility for businesses operating in the global economy. A review of the literature on corporate social responsibility identified four models for designing a corporate governance structure that constitutes elements of good corporate citizenship. This paper outlines evidence-based research for businesses operating in the global economy as good corporate citizens. Results aim to advance research on business relations in the global economy by understanding better business's participation in the global economy. Implicit in the four models of corporate social responsibility is performance beyond corporate performance (Locke, 2003). In conclusion, good corporate citizenship includes adding value to society beyond corporate performance.

**Keywords:** corporate citizenship, corporate social responsibility, business relations, corporate governance

## **Reference**

Locke, R.M. (2003). The Promise and Perils of Globalization: the case on Nike. In T.A. Kochan and R.L. (Ed.), *Management: Inventing and Delivering Its Future*. Cambridge, MA: MIT Press, 39-70.

# **Lessons From the Project Management Field: The Search for Most Effective Methods for Successful Turn-Key Project Execution**

Ildiko K. Nyeste and Ramakrishna Govindu

The College of Business  
University of South Florida Sarasota-Manatee, United States

## **Abstract**

Project management plays a crucial role in the success of any business enterprise (Gale, 2009). The successful execution of a project depends on the competency of the project manager, the proper application of management tools and techniques, and the organizational support systems in place, among others (Gale, 2009). Industrial case studies on project management provide excellent inputs in terms of best practices to adopt that helps manage projects better and at the same time provide valuable lessons learned in terms of pitfalls to avoid that would prove detrimental to ensure project success. This case study examines the effectiveness of different project management tools and processes utilized during a complex multi-million dollar installation which includes a bottling line running at 400 bottles per minute, by a packaging machinery manufacturer.

In this specific case of a turn-key project, the manufacturer in context was responsible for engineering, manufacturing several pieces of equipment, procuring third party equipment, logistics, installation, integration, testing and project turn-over to the client. In order to ensure successful execution, the main challenges in managing a project of this scale are dealing with and reacting to unforeseen problems, reliance on different departments, vendors, contractors, customer demand and scope change on the one hand; while simultaneously trying to stay on schedule and within budget without sacrificing quality on the other. The fact that we are a global company and some of the equipment was built in different facilities in different countries only magnified the complexity of this project.

Research analysis was performed first looking at the project initiation and planning stages and a list of all applicable techniques were generated. The generated project plan was then compared to the actual execution of the project to identify all the occurrences where the schedule and plan deviated from the original. Next, all the triggers for the divergences were listed along with the decision making process or tools and the type of decisions that were made. Subsequently, the time and cost impact of each decision were identified. During the actual execution and control phases, some decisions needed quick responses and had to be made on the spot with no time to do any assessment of their impact. Such decisions are categorized as: i) decisions that needed quick reaction time mostly within hours, and ii) decisions that allowed more time to process and analyze usually at least 24 hours or more. Analysis of the data during the execution phase indicated that about 80% of decisions fell into the first category (decisions had to be made very quickly) with the remaining 20% of the decisions falling into the second category (where we had more time to make the decisions). Further analysis of the decisions in the second category led to the identification of tools utilized, and most of them were related to cost and time tradeoff analyses and particularly crashing where we looked at the lowest-cost approach to reduce or make up time. These techniques were then applied on the first category of decisions to validate whether the decisions based on the data analysis would match up with the actual ones made on the spot. Surprisingly (and thankfully) most decisions we came to using the cost and time tradeoff analysis

matched up with the actual decisions made. Finally in the control phase, every incident that caused changes in lead time and cost were carefully examined and compared to the actual data. It turned out that 95% of the incidences were captured during the project and dealt with within couple days. If the incident was caused by outside factors, for example vendor delays, we were able to recoup associated costs if the issue was raised and captured right away. Obviously for some of the delays happened with our organization being responsible leading to reduction in our margins.

The results of the analyses clearly showed that the initiation and planning phases are the most critical from the project success standpoint. The Quoting Department carefully defines the scope of the project which becomes a legal contract. We found that while generating a promised completion duration timeline, the process was not consistent in how the lead times were determined. In this case, the Quoting Department did not use the critical path method to give a realistic time frame for project completion. Additionally, we have to provide a lead time without knowing the exact start date of the project. When we quote a large project, we do not know when the contract will be awarded to us. Even if we receive an estimated start date from the customer, by the time the contract is drafted, revised and signed by both the parties, our available resources can change because of other commitments. However, due to the highly competitive bidding process we cannot change the lead time, scope or sales price. Due to these variables, another important useful tool would have been the Program Evaluation and Review Technique (PERT) where the uncertainties are captured and integrated into the analysis to give management a better understanding for the chances of completing the project on time and under budget. (Boyer & Verma, 2009).

During the execution and control phase, the cost and time tradeoff analysis tool is very important (Boyer & Verma, 2009). If there is no time to utilize it before the decision, it has to be applied after the fact. This tool allows the project manager to capture the cost and time impact, and to monitor the progress of the project. If there are major impacts the project manager needs to raise the flag and advise the client and management so they can plan for contingencies. Documenting every scope change, extra cost, extra time and the reasons behind them is important as well. This document will help the project manager to justify time and budget increases to management and the client, and also in recouping costs from suppliers and contractors should they be responsible for the delays and changes.

In conclusion, the results of this study prompted management to implement the Program Evaluation and Review Technique (PERT). This tool is the most effective to anticipate uncertainties in project duration and develop contingency plans, and will be utilized in managing projects in future.

**Keywords:** packaging, bottling, installation

## References

- Boyer, & Verma. (2009). Operations and Supply Chain Management for the 21st Century. TBS.
- Gale, S. F. (2009). Closing the gap: The link between project management excellence and long-term success. Economist Intelligence Unit. Retrieved from:  
[http://graphics.eiu.com/upload/eb/Oracle\\_Project\\_Man\\_WEBr1.pdf](http://graphics.eiu.com/upload/eb/Oracle_Project_Man_WEBr1.pdf) (accessed on March 27th, 2018.)

# Design for Participation: Modular Service Approach

Syed Aamir Ali Shah<sup>1</sup> and Muhammad Shakeel Sadiq Jajja<sup>2</sup>

<sup>1,2</sup> Suleman Dawood School of Business (SDSB)

Lahore University of Management Sciences (LUMS), Pakistan

<sup>1</sup>Department of Business Administration

Sukkur Institute of Business Administration (IBA) University, Pakistan

## Abstract

One of the most remarkable aspect about service businesses is value co-creation. The service product/process is co-created by the customer and the service provider together. Customers provide their time, effort, information & knowledge, and resources besides active engagement in the design and delivery of the service that they are actually paying for (Dong et al., 2015). Accordingly, customers in service settings are not merely consumers but also partners that take a variety of roles during the service creation. Thus, from the service provider's perspective, it is critical to effectively and efficiently manage the participation of customers in service design and delivery.

Extant research has considered various management philosophies, perspectives (the marketing, human resource management, and operations management) and practices to manage the behavior and interactions with the customer (Mustak et al., 2016). However, none of the studies have used the service design level structural choices such that by design the service processes are participatory and thus during the delivery, the participation is managed precisely and effectively. Thus, the question remains unanswered how can service firms design their processes that lead to effective customer participation in the value co-creation?

The purpose of this article is to develop and empirically test a design-based framework for managing customer participation efficiently and effectively in co-creating the overall value in the service organization. Using the structure-conduct-performance paradigm and role theory, we employ the concept of service modularization (structural design choice) (Pekkarinen & Ulkuniemi, 2008; Voss & Hsuan (2009) and customer training and education (infrastructural design choice) (Damali et al., 2016) as a potential way to analyze and manage the participation of customers (conduct) (Sampson and Spring, 2012) in the service value creation (performance). Based on the contingency theory, we also study the potential role of service modularization as the moderator in the relationship between customer training & education and effective customer participation.

In order to test the proposed relationships, empirical quantitative technique will be used. A questionnaire survey would be employed to collect the data. Our target sample would be the firms from multiple service industries with Pakistan. All the standard practices of survey research including pretesting, multiple key respondents, follow-ups, etc will be undertaken as suggested by Dillman et al. (2009). Moreover, the measures for service modularity, effective customer participation, customer training & education and operational performance are adopted from existing research (Cheng & Shiu, 2016; Damali et al., 2016; Sampson & Spring, 2012; Vickery et al., 2016).

**Keywords:** service modularity, service design, customer participation, customer training and education, empirical



## References

- Damali, U., Miller, J. L., Fredendall, L. D., Moore, D., & Dye, C. J. (2016). Co-creating value using customer training and education in a healthcare service design. *Journal of Operations Management*, 47-48, 80-97. doi: <https://doi.org/10.1016/j.jom.2016.10.001>
- Dillman, D. A., Smyth, J. D., & Melani, L. (2009). Internet, mail, and mixed-mode surveys: The tailored design method.
- Dong, B., Sivakumar, K., Evans, K. R., & Zou, S. (2015). Effect of customer participation on service outcomes: the moderating role of participation readiness. *Journal of Service Research*, 18(2), 160-176.
- Mustak, M., Elina, J., Aino, H., & Valteri, K. (2016). Customer participation management: Developing a comprehensive framework and a research agenda. *Journal of Service Management*, 27(3), 250-275. doi: [doi:10.1108/JOSM-01-2015-0014](https://doi.org/10.1108/JOSM-01-2015-0014)
- Pekkarinen, S., & Ulkuniemi, P. (2008). Modularity in developing business services by platform approach. *The International Journal of Logistics Management*, 19(1), 84-103. doi: [doi:10.1108/09574090810872613](https://doi.org/10.1108/09574090810872613)
- Sampson, S. E., & Spring, M. (2012). Customer Roles in Service Supply Chains and Opportunities for Innovation. *Journal of Supply Chain Management*, 48(4), 30-50. doi: [10.1111/j.1745-493X.2012.03282.x](https://doi.org/10.1111/j.1745-493X.2012.03282.x)
- Vickery, S. K., Koufteros, X., Dröge, C., & Calantone, R. (2016). Product Modularity, Process Modularity, and New Product Introduction Performance: Does Complexity Matter? *Production and Operations management*, 25(4), 751-770. doi: [10.1111/poms.12495](https://doi.org/10.1111/poms.12495)
- Voss, C. A., & Hsuan, J. (2009). Service Architecture and Modularity\*. *Decision Sciences*, 40(3), 541-569. doi: [10.1111/j.1540-5915.2009.00241.x](https://doi.org/10.1111/j.1540-5915.2009.00241.x)uthor, A. A., Author, B. B., & Author, C. C. (Year). Title of article. Title of Journal, volume number (issue number), pages.
- Cobanoglu, C., & Cobanoglu, N. (2003). The effect of incentives in web surveys: application and ethical considerations. *International Journal of Market Research*, 45(4), 475-488.

# *Marketing*

# The Impacts of Merchant Photos on Consumers' Purchase Probability on P2P Short-Term Rental Platform: Based on the Mediated Effect of Initial Trust

Hui Wu<sup>1</sup>, Jing Chen<sup>1</sup>, Muhittin Cavusoglu<sup>2</sup>, and Cihan Cobanoglu<sup>3</sup>

<sup>1</sup>College of Business Administration  
Hunan University, China

<sup>2</sup>College of Education  
University of South Florida, USA

<sup>3</sup>College of Hospitality & Tourism Leadership  
University of South Florida Sarasota-Manatee, USA

## Abstract

Aimed to serve the Peer-2-Peer market, the shared rental housing platform (hereinafter referred to as the “Short-term rental platform for tourism”) has been flourishing in recent years, and attracted extensive attention from the business community and academia. However, the research mainstream mostly focused on the business models, the issues in the development process, and consumer motivation, etc., but ignored the impact of personal information of merchants (such as merchant photos) on consumers' purchase behavior. Furthermore, very limited study has investigated their relationship by the empirical methods.

In view of the existing research deficiencies, this article takes use of the Face Process Theory and the Cue Utilization Theory. From the perspective of corporate practice, this study selects the merchant photos and the merchant reputation which occupy important position in the short-term rental website interface, initial trust, and consumers' purchase probability as variables. It addresses the impact of social impression perception which based on merchant photos and merchant reputation on consumers' purchase probability, the mediated role that initial trust played in the relationship between social impression perception, merchant reputation and consumers' purchase probability.

After collecting 302 valid scenario-based questionnaires from online and offline, we firstly used SPSS 20.0 for modeling test. Results shows that the key four constructs ,i.e., social impression perception, merchant reputation, initial trust and consumers' purchase probability have good discriminant validity. Secondly, the average variance extracted (AVE) values of each variable, the factor loading of all items, and the Cronbach's alpha for all measures predicting convergent validity and good reliability. Thirdly, we reported the respondents' demographics. Lastly, we conducted hierarchical regression to evaluate the hypothesized relationships among the constructs in our proposed model.

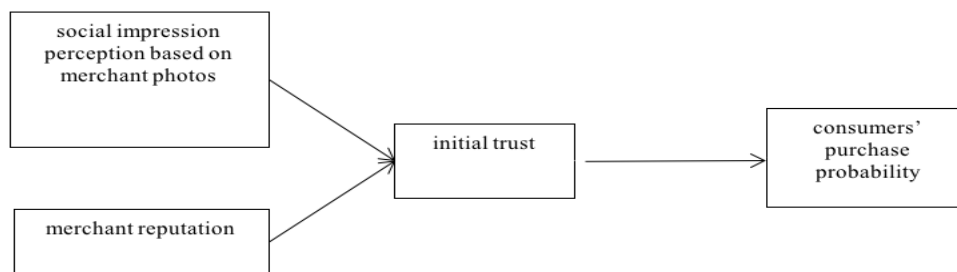

Figure 1. Proposed model

The results of data analysis suggest that: (1) both photo-based social impression perception and merchant reputation have positive impact on consumers' purchase probability, while social impression perception is a more significant and stronger predictor; (2) initial trust partially mediates the relationships between social impression perception and consumers' purchase probability, and between merchant reputation and consumers' purchase probability, specially, both social impression perception and reputation positively influence initial trust, and initial trust has positive impact on consumers' purchase probability; (3) there is interaction effect of photo and reputation on initial trust.

The findings provided several theoretical and managerial implications. On the one hand, from the perspective of the Face Process Theory, the relationship among photos, initial trust and purchase probability were interpreted, thus this study extends the application scope of the theory. On the other hand, this paper firstly explores the role of initial trust in Peer-2-peer short-term rental platform, and examines the combination of photos and reputation, which also confirms the interaction effect between independent variables, accordingly enriches existing research in a sense. Merchants and marketing practitioners should endeavour to manage photos and improve reputation scores, thus enhancing consumers' initial trust and promoting their purchase probability

**Keywords:** P2P short-term rental platform, merchant photos, perceived social impression, reputation, initial trust

# The Effect on Consumer Attitude of SMS Advertising

Remzi Reha Durucasu

Eskişehir Vocational School  
Anadolu University, Turkey

## Abstract

Nowadays, with the advance in mobile communication devices, people are able to get in touch with each other more than ever. Since the mobile communication allows businesses to get in touch with their clients almost instantly, every company wants to take this as their advantage. Especially instant messaging becomes an internal part of the communication with customers, instant messages allows customers to read the information whenever they want. SMS is almost the cheapest option to give information to the customers, therefore it is preferred by many companies. SMS is becoming an advertisement tool especially in developing countries, which is the situation in Turkey also. The Mobile phone customers may allow businesses to sent information and advertisement messages. Under the knowledge and personal rights law of Turkey, a mobile customer may also block these SMS to be sent from different companies. Most of the companies use SMS messages as an advertisement tool in Turkey, and this makes a good opportunity for the marketing research scientist to study the subject in terms of both parties, customer and company. Marketing departments of many companies constantly try to understand how effectively an SMS be used without annoying the customer. How much information can be passed through SMS is limited so a company should give all the necessary information as clearly as possible to customer. In this study, the effect of SMS advertisements on the consumer attitudes are investigated. A survey is applied to university students in Anadolu University, Turkey. There are several research hypothesis in this study among which a hypothesis testing of the relationship between demographic characteristics of the students and SMS advertisement opinions. Additionally, in this study, some of the results obtained via factor analysis and cluster analysis are shown in detail.

**Keywords:** mobile marketing, mobile advertisement SMS, attitude

## References

- Carroll, A., Barnes, S., Scornavacca, E, ve Fletcher, K. (2007). Consumer perceptions and attitudes towards SMS advertising: Recent evidence from New Zealand. *International Journal of Advertising*, 26 (1), 79-98.
- Cho, Y. C. (2008). Assessing user attitudes toward mobile commerce in the U.S. vs. Korea: implications for m-commerce crm. *Journal of Business & Economics Research*, 6 (2), 91-102.
- Griffiths, B. ve Pedersen, A. (2009). Prejudice and the function of attitudes relating to Muslim Australians and Indigenous Australians. *Australian Journal of Psychology*, 61 (4), 228-238.
- Merisavo, M., Kajalo, S., Karjaluoto, H., Virtanen, V., Salmenkivi, S., Raulas, M. ve Leppaniemi, M. (2007). An empirical study of the drivers of consumer acceptance of mobile advertising. *Journal of Interactive Advertising*, 7 (2), 41-50.
- Okazaki, S. ve Taylor, C. (2008). What is SMS advertising and why do multinationals adopt it? Answers from an empirical study in European markets. *Journal of Business Search*, 6 (3), 4-12.

# Reviewing CSR Promotional Communication Strategy in Hospitality Industry: Analyzing A Case Study

Aysegul Songur

Department of Communication  
University of North Florida, USA

## Abstract

This paper aims to explore the CSR Promotional Communication Strategy implemented by a number of prominent hospitality companies such as *Hilton Worldwide*, *Wyndham Worldwide*, *Marriott International* and *Loews Corporation* by elucidating the CSR initiatives participated which comprise the overall CSR strategy and how it is conveyed via various communication channels to their stakeholders in the form of CSR promotional communication strategy.

**Keywords:** corporate social responsibility, public relations, corporate communication, CSR communication, marketing communication, hotels, hospitality.

## Introduction

Today, the role of business is no longer business alone in the sense of sales, profits, market share etc. so companies need to consider their role in the wider society in which they operate and the impact that this role has to the community at large. Companies should take their wider role seriously given issues such as pluralism, reputation, likelihood of government intervention, public opinion demands, and sustaining an unwritten 'license to operate'. To be able to fulfill such a wider role, companies need to balance a number of interests, and align social responsibility programs with corporate objectives. (Kitchen: 1997, p: 130) European Commission defines CSR as "*the responsibility of enterprises for their impact on society. CSR should be company led. Public authorities can play a supporting role through a smart mix of voluntary policy measures and, where necessary, complementary regulation*".(ec.europa.eu/growth/industry/corporate-social-responsibility\_en). CSR is a commitment to improve community well-being through discretionary business practices and contributions of corporate resources (Kotler & Lee: 2005, p:3). Drawing on such perspectives, CSR is now widely accepted as a multi-dimensional concept with commonly identified key dimensions such as the community, employees, the natural environment and customers, comprising altogether the stakeholder theory framework, which was initially put forward by Abrams, when he utterly said "Business firms are man-made instruments of society. They can be made to achieve their greatest social usefulness and thus their future can be best assured when management succeeds in finding a harmonious balance among the claims of the various interested groups: the stockholders, employees, customers, and the public at large" (Abrams, Ibid. 29-30).

Past few decades have seen the evolution and conceptualization of the CSR and the way it is communicated. The concept of communication is at the core of the CSR process and once a CSR initiative is created it has to be communicated to both internal stakeholders "employees" and external stakeholders of the organization which includes all those affected by the CSR initiative decision and any stakeholders who have a general interest in the corporation's CSR activities such as local communities, NGOs, traditional and online media, suppliers, customers, investors and retailers (Coombs & Holladay: 2012, p. 110). Especially after the turn of the new millennium,

amongst tourism and hospitality scholars, a growing interest in the concept of CSR has been observed which led to a comprehensive body of research with a focus on benefits of CSR activities in hospitality organizations. The underlying reason for this interest is due to the intrinsic link between different communities comprising the society and the hospitality industry in terms of various social, economic, environmental and cultural concerns for which the industry itself can create benefits through its support of job creation, improvements to infrastructures and cultural understanding (Bohdanowicz & Zientara, 2009). For hospitality companies, communicating their CSR strategy is crucial in the way that it lessens the skepticism and potentially increases the stakeholder engagement. Since the year 1992, the CSR trend in hospitality and tourism industry has shifted from a focus on environmental concerns, use of technology, and efficient use of energy to an international scale through the implementation of agenda 21; international guidelines relative to sustainable tourism introduced by World Travel and Tourism Council (WTTC) and the World Tourism Organization (WTO) (Holcomb et al., 2007).

## **Methodology**

An exploratory study was conducted in order to reach a thorough understanding of the CSR Promotional Communication Strategy implemented by a number of prominent hospitality companies such as *Hilton Worldwide*, *Wyndham Worldwide*, *Marriott International* and *Loews Corporation* which were chosen from the CSR Hub Ranking out of a group of hospitality companies with significant levels of CSR rating compared to all companies. The basic objectives of the study regarding the investigated companies are as follows:

- Determining the top management's perspective regarding CSR strategy.
- Elucidating the CSR initiatives participated which comprise the overall CSR strategy
- Defining the existing and potential stakeholders as the beneficiaries of the CSR Strategy
- Describing the CSR promotional communication strategy and Public Relations (PR) efforts
- Disseminating best practice of CSR promotional communication strategy as exemplified by the hospitality companies investigated

Primary data has been systematically gained through semi-structured interviews with executive staff and administrators responsible for the CSR to reach a more in-depth understanding of CSR and overall CSR promotional communication strategy of the above mentioned hospitality companies. To identify how CSR information is being communicated to the stakeholders, various conventional forms of marketing communication and PR tools such as *annual reports*, *CSR reports and/or sustainability reports*, *marketing brochures*, *newsletters*, *press releases* alongside with online communication channels such as *corporate websites*, *social media platforms*, *blogs for employees/partners/customers* were examined as sources of secondary information to complement the primary data obtained from the in-depth interviews.

## **Conclusion**

In a high touch industry like the hospitality industry where communicating with and more importantly promoting the organization/establishment to its various stakeholders vis-à-vis the CSR credentials accrued by the CSR communication strategy is a challenging task. This paper is based upon a preliminary case study regarding how the investigated hospitality companies manage their overall CSR promotional communication strategy or in a more specific sense, how various

marketing communication tools and PR efforts employed by these hotel companies contribute to the process of highlighting, publicizing and promoting the organizational CSR policies implemented. This paper's contribution primarily lies in reducing the particular literature gap by bringing insights into CSR promotional communication practices based on an exploratory research conducted with a selected sample of hospitality companies especially in a marketing communication environment with a predominance of online communication channels.

## References

- Abrams, F. (1951) Management's Responsibilities in a Complex World. *Harvard Business Review*, Vol. 29 No.3, pp. 29-34.
- Banerjee, S.B. (2009) *Corporate Social Responsibility: The Good, the Bad and the Ugly*. Northampton, MA: Edward Elgar Publishing.
- Blau, P.M. (1968) Interaction: Social Exchange, *International Encyclopedia of the Social Sciences*, 7, 452-458.
- Bohdanowicz, P. & Zientara, P. (2009) Hotel companies' contribution to improving the quality of life of local communities and the well-being of their employees. *Tourism and Hospitality Research*, Vol.9, No.2, pp.147-158.
- Cantrell, J.E., Kyriazis, E. & Noble, G. (2015) Developing CSR giving as a dynamic capability for salient stakeholder management. *Journal of Business Ethics*. Vol.130 No.2, pp. 403-421.
- Coombs, W.T. & Holladay, S.J. (2012) *Managing Corporate Social Responsibility A Communication Approach*. Oxford: John Wiley and Sons.
- Daymon, C. & Holloway, I. (2002) *Qualitative Research Methods in Public Relations and Marketing Communications*. London: Routledge.
- ec.europa.eu/growth/industry/corporate-social-responsibility\_en
- Friedman, M. (1962) *Capitalism and Freedom*, Chicago: University of Chicago Press.
- Holcomb, J.L., Upchurch, R.S. & Okumus, F. (2007) Corporate Social Responsibility: what are top hotel companies reporting? *International Journal of Contemporary Hospitality Management*. Vol. 19 No.6 pp. 461-475.
- Kitchen, P. J. (1997) *Public Relations Principles and Practice*. Boston: International Thomson Business Press.
- Kotler, P. & Lee, N. (2005) *Corporate Social Responsibility Doing the Most Good for Your Company and Your Cause*, New Jersey: John Wiley & Sons, Inc.
- Liu, F., Wang, X., Tian, X & Tang, Y. (2017) The Effect of Corporate Social Responsibility on Hotel Employees' Work Outcomes: The Mediating Role of Organizational Identification. *Service Systems and Service Management (ICSSSM)*, 2017 International Conference. DOI: 10.1109/ICSSSM.2017.7996215
- Wood, D.J. & Jones, R.E. (1995) Stakeholder mismatching: a theoretical problem in empirical research on corporate social performance. *The International Journal of Organizational Analysis*, Vol. 3 No. 1, pp. 229-267.



## *Strategy & Global Trends*

# Effects of Perceived Authenticity on Festival Attendees' Loyalty: The Moderating Role of Motivation

Hyeongjin Jeon<sup>1</sup> and Juwon Choi<sup>2</sup>

<sup>1</sup>College of Human Ecology  
Kansas State University, United States

<sup>2</sup>College of Business  
The University of Southern Mississippi, United States

## Abstract

Authenticity represents an individual's perception of the genuineness of products and experiences (Brida, Disegna, & Osti, 2013; Brown & Patterson, 2000; Leigh, Peters, & Shelton, 2006). Because cultural tourists tend to weigh their personal beliefs or perspectives when they evaluate the value of originality toward the toured object, the perception of authenticity has become an important indicator to predict the cultural tourists' attitudes and future behaviors (Reisinger & Steiner, 2006; Zhou, Zhang, & Edelman, 2013). With the proliferation of festivals providing a unique experience to attendees, perceived authenticity has been emphasized for understanding attendees' experience because they seek novelty and an escape from their daily life (Formica & Uysal, 1995; Lee, Lee, & Wicks, 2004; Xie, Wu, & Hsieh, 2012). Given the monetary and non-monetary benefits to the destinations of festivals, it is critical for festival organizers to keep the flow of attendees (Lee, 2016). Thus, identifying factors that drive festival attendees' loyalty has caught attention. As an effective predictor of loyalty, prior research has suggested positive emotion (Organ, Koenig-Lewis, Palmer, & Probert, 2015), festival value (Lee, Lee, & Yoon, 2009; Yoon, Lee, & Lee, 2010), and festival satisfaction (Jung, Ineson, Kim, & Yap, 2015; Kim, Suh, & Eves, 2010). Further, a handful of literature has recently posited that perceived authenticity leads to festival attendees' loyalty (Akhoondnejad, 2016; Robinson & Clifford, 2012). However, some empirical studies about the effect of perceived authenticity on loyalty showed inconsistent findings. Therefore, this calls for examining the boundary condition of the effect of perceived authenticity on loyalty. To address the issue unsolved, the purpose of this study is to examine the moderating effects of festival attendees' motivation on the relationship between perceived authenticity and loyalty. Because studies have suggested that motivation is a significant factor to function the development of perceived authenticity and loyalty (Bryce, Curran, O'Gorman, & Taheri, 2015; Kolar & Zabkar, 2010; Zhou et al., 2013), the effectiveness of perceived authenticity may rely on an attendee's motivation to visit the festival.

The study sample will be Renaissance Festival attendees who have visited at least once within the past 12 months. This study will use an online survey company (i.e., Qualtrics) to recruit potential participants. The survey will be distributed to the consumer panel of the company. Measurement items will be developed based on the pertinent studies. Collected data will be analyzed using SPSS v.17.0 and AMOS v.18.0. A confirmatory factor analysis and a structural equation modeling will be employed. Once the model is validated, both cluster analysis and discriminant analysis will be conducted to identify groups of festival attendees in terms of differences in their motivation. The multiple group analysis will be used to test the moderating effect of motivation.

The findings of this study will offer several contributions. First, this study will expand on existing literature by providing an advanced understanding of the effectiveness of perceived authenticity

as a predictor of festival attendees' loyalty. Second, we examine the boundary conditions of the effect of perceived authenticity on loyalty and provide a possible explanation for the mixed empirical findings in the literature. Practically, festival organizers might learn under what conditions perceived authenticity works for encouraging festival attendees' loyalty.

**Keywords:** authenticity, loyalty, motivation, festival

## References

- Akhoondnejad, A. (2016). Tourist loyalty to a local cultural event: The case of Turkmen handicrafts festival. *Tourism Management*, 52, 468-477.
- Brida, J. G., Disegna, M., & Osti, L. (2013). The effect of authenticity on visitors' expenditure at cultural events. *Current Issues in Tourism*, 16(3), 266-285.
- Brown, S., & Patterson, A. (2000). Trade softly because you trade on my dreams: A paradisaal prolegomenon. *Marketing Intelligence & Planning*, 18(6/7), 316-320.
- Bryce, D., Curran, R., O'Gorman, K., & Taheri, B. (2015). Visitors' engagement and authenticity: Japanese heritage consumption. *Tourism Management*, 46, 571-581.
- Formica, S., & Uysal, M. (1995). A market segmentation of festival visitors: Umbria Jazz Festival in Italy. *Festival Management and Event Tourism*, 3(4), 175-182.
- Jung, T., Ineson, E. M., Kim, M., & Yap, M. H. (2015). Influence of festival attribute qualities on Slow Food tourists' experience, satisfaction level and revisit intention: The case of the Mold Food and Drink festival. *Journal of Vacation Marketing*, 21(3), 277-288.
- Kim, Y. G., Suh, B. W., & Eves, A. (2010). The relationships between food-related personality traits, satisfaction, and loyalty among visitors attending food events and festivals. *International Journal of Hospitality Management*, 29(2), 216-226.
- Kolar, T., & Zabkar, V. (2010). A consumer-based model of authenticity: An oxymoron or the foundation of cultural heritage marketing? *Tourism Management*, 31(5), 652-664.
- Lee, C. K., Lee, Y. K., & Wicks, B. E. (2004). Segmentation of festival motivation by nationality and satisfaction. *Tourism Management*, 25(1), 61-70.
- Lee, Y. K. (2016). Impact of government policy and environment quality on visitor loyalty to Taiwan music festivals: Moderating effects of revisit reason and occupation type. *Tourism Management*, 53, 187-196.
- Lee, J. S., Lee, C. K., & Yoon, Y. (2009). Investigating differences in antecedents to value between first-time and repeat festival-goers. *Journal of Travel & Tourism Marketing*, 26(7), 688-702.
- Leigh, T. W., Peters, C., & Shelton, J. (2006). The consumer quest for authenticity: The multiplicity of meanings within the MG subculture of consumption. *Journal of the Academy of Marketing Science*, 34(4), 481-493.
- Organ, K., Koenig-Lewis, N., Palmer, A., & Probert, J. (2015). Festivals as agents for behaviour change: A study of food festival engagement and subsequent food choices. *Tourism Management*, 48, 84-99.
- Reisinger, Y., & Steiner, C. J. (2006). Reconceptualizing object authenticity. *Annals of Tourism Research*, 33(1), 65-86.
- Robinson, R. N., & Clifford, C. (2012). Authenticity and festival foodservice experiences. *Annals of Tourism Research*, 39(2), 571-600.
- Xie, P. F., Wu, T. C., & Hsieh, H. W. (2012). Tourists' perception of authenticity in indigenous souvenirs in Taiwan. *Journal of Travel & Tourism Marketing*, 29(5), 485-500.
- Yoon, Y. S., Lee, J. S., & Lee, C. K. (2010). Measuring festival quality and value affecting visitors' satisfaction and loyalty using a structural approach. *International Journal of Hospitality Management*, 29(2), 335-342.
- Zhou, Q. B., Zhang, J., & Edelman, J. R. (2013). Rethinking traditional Chinese culture: A consumer-based model regarding the authenticity of Chinese calligraphic landscape. *Tourism Management*, 36, 99-112.
- Bryce, D., Curran, R., O'Gorman, K., & Taheri, B. (2015). Visitors' engagement and authenticity: Japanese heritage consumption. *Tourism Management*, 46, 571-581.

# International Collaboration Management

Brent J. Cunningham and Dan Mertens

The School of Business and Industry  
Jacksonville State University, USA

## Abstract

Business is a global endeavor which advances when knowledge is both generated and shared. Increasingly, academics are working both within and outside of national boundaries on local and global business issues and disciplines. Challenges necessitating innovation and international scientific collaboration are abundant throughout business disciplines. Universities with varying levels of research, teaching, and service may have different goals and expectations for international scientific engagement, but there are minimum expectations.

AACSB, AMBA, EQUIS and other top accrediting agencies continue to emphasize and increase faculty publishing requirements. As globalization continues to increase, the number of researchers with international collaboration research endeavors grows. Most top-tier research universities have witnessed significant growth in their international exchange of ideas, expertise, and faculty activities. Many new research ventures unite researchers from different countries and promote synergistic, collaborative efforts with the creation/exchange of ideas. The authors of this symposium are no different.

The focus of this proposal is how a department head manages faculty who develop in areas outside of the university's traditional parameters. Many teaching-institutions inadvertently handcuff department heads and deans regarding developing and funding research collaborations. Other than possible sister campuses in other countries, teaching institutions have limited options and tend to have myopic vision concerning such collaborations. However, when dedicated research faculty and department heads think outside the box to construct opportunities, research support can be found.

In this example, a researcher at a North American, AACSB, teaching-focused university had difficulty obtaining funding and support for international research. The difficulties for administration to accept and promote such international collaborative research endeavors are significant. Teamwork between the research faculty and the department head is crucial. Sabbaticals involving the extension of a current stream of research are the very traditional, myopic ideas teaching institutions should avoid. We aim to suggest techniques which in the early stages of aid faculty access to the significant pools of talent existing globally in different countries, universities, and disciplines.

This collaboration brought together members from a variety of ranks (Professor, Associate Professor, PhD student), countries (U.S., Australia, China) and disciplines (Decision-Making, Organizational Behavior, Emotions) for new research streams. Word of this new branch of research spread internationally and several more similar strains of research developed as a result.

**Keywords:** international, collaboration, research

# Can New Strategies Keep Universities from Going Bust?

Chandra Aleong

Delaware State University, USA

## **Abstract**

Universities need to revisit and renew their strategies. This means reviewing its portfolio of program offerings and market opportunities, revisiting its capital investments, disposing of underutilized and unused assets, even merging with other institutions to explore new areas of research, teaching, and service opportunities. The Gen Z's and the millennial generation view the world differently especially from social and technological viewpoints. Their needs for work/life balance and social good have to be focal points for future growth. With the right strategies and execution universities can bounce back to good health but there must be no sacred cows. This paper will examine how leading universities are reinventing themselves without sacrificing quality in their primary missions of research, teaching, and service.

**Keywords:** strategies, market opportunities, millennials, social good

# Factors Influencing Outbound Medical Travel From the USA

Ayse Collins<sup>1</sup>, Anita Medhekar<sup>2</sup>, Ho Yin Wong<sup>3</sup>, and Cihan Cobanoglu<sup>4</sup>

<sup>1</sup>School of Applied Technology and Management,  
Bilkent University, Turkey

<sup>2</sup>School of Business and Law

<sup>3</sup>Central Queensland University, Rockhampton, Australia  
Department of Marketing

Deakin University, Burwood, Australia

<sup>4</sup>College of Hospitality and Tourism Leadership  
University of South Florida Sarasota-Manatee

## Abstract

The phrase “medical tourism” and “health tourism” have been used interchangeably recently in the related fields since it is multidisciplinary, and includes the management of healthcare, trade in healthcare services, health economics, tourism economies, marketing and promotion, and legal, ethical, social, and regulatory issues (Jones & Keith, 2006; Connell, 2006; Bookman & Bookman, 2007; Turner, 2010 & 2013; Smith, Chanda & Tangcharoensathien, 2009; Whittaker, 2010; Gan & Frederick, 2011; Crozier & Martin, 2012; Noree, Hanefeld & Smith, 2014).

Therefore, it has been defined from those perspectives emphasizing different focal points. Health tourism, according to Carrera and Bridges (2006), is seen “as the organised travel outside one’s local environment for the maintenance, enhancement or restoration of the individual’s wellbeing in mind and body” (p. 449)...Whereas, medical tourism is a subset of health tourism, invasive in nature, using state-of-the-art technology and “organised travel outside one’s natural healthcare jurisdiction for the enhancement or restoration of the individual’s health through medical intervention (p. 449). According to Bies and Zacharia (2007), medical tourism is “simply the outsourcing of medical services, primarily expensive surgeries, to low cost countries such as India and Thailand” (p. 1144).

Traditionally, wealthy people were travelling from developing countries to Europe, UK, and the U.S. for medical surgeries. However, in the 21st century, many developing countries like Thailand, India, Malaysia, Poland, Turkey, Mexico, Brazil, and Venezuela have emerged as popular medical tourism destinations, offering the affordable quality of Joint Commission International (JCI) accredited surgeries at an attractive destination with pre- and post-surgery nursing care (MacReady, 2007; Turner, 2007). Globalisation, privatisation of healthcare and the internet revolution has led to the growth of this industry. Medical tourism is driven by market forces of demand and supply, where choice of country and medical facility is based on economic, political, and regulatory conditions, the healthcare facility itself, costs, accreditation, physicians’ level of training, and quality of care (Bookman & Bookman, 2007; Smith & Forgione, 2008; Heung, Kucukusta & Song, 2011; Medhekar, Wong & Hall, 2014a; Connell, 2015; Woodman, 2015).

There are various factors influencing outbound medical travel such as a country’s environment, the destination, the cost of the desired healthcare, and the quality of the medical tourism facility and its services.

Medical tourists and medical tourism facilitators make their choices based on the accreditation of hospitals by professional bodies such as JCI, which is dedicated to improving the quality in healthcare delivery all over the world. Furthermore, the International Society must accredit all accrediting bodies for Quality Assurance (ISQUA) in healthcare to ensure that other accrediting bodies are doing their job properly. A study by Guiry, Scott and Vequist (2013) surveyed potential and experienced U.S. medical tourists expressing an interest in travelling abroad for surgery. A physician's expertise and judgement in providing medical care to patients with positive healthcare outcomes predicts the quality of healthcare (Mehrotra et al., 2006). Similarly, Manaf et al. (2015) empirically tested perceived value as a driver in the case of Malaysia and they identified quality in context of medical staff, supporting services, and administrative services. In their findings, quality of medical staff was considered very important for patient satisfaction. Perfetto and Dholakia (2010) drew conclusions after reviewing freely available medical tourism US patients' internet discussions about medical tourism, who were looking for First World quality healthcare at Third World costs of healthcare. They observed that "little cultural and economic capital in society...and perceive themselves feel as abandoned as well, by the American healthcare system and by society" (p. 399), further influencing the global healthcare and medical system to be like the U.S. in the context of quality, accreditation, and the regulation of First World healthcare systems. While these studies shed light on various issues related to the medical tourism industry, most of them are conceptual papers without much empirical evidence related to why American medical tourists are travelling abroad for surgery.

The aim of this quantitative study is to explore how Americans choose a destination and medical facility to travel abroad for medical treatment based on tourist destination attributes, the country itself, medical and travel costs, and the quality of medical facilities and services.

The study employed self-administered questionnaires to explore how Americans choose a destination and medical facility to travel abroad for medical treatment based on tourist destination attributes. A survey was conducted with the U.S. residents who travelled to another country for a medical treatment within the last 12 months. A total of 1246 respondents were collected from U.S. residents with the help of the Amazon Mechanical Turk website. The questionnaire started with one screening question that checked whether or not respondents had been to a country for medical reasons. If the respondent never travelled to another country for medical reasons, the survey ended. If they had travelled to another country for medical reasons, the questionnaire continued with questions about the country selected for medical treatment, the selection process, and the importance of selection criteria. The questions about the selection criteria were grouped under: country environment, tourism destinations, medical tourism costs, facilities, and services. There were 59 items in this survey, 25 of which were new items, and 34 of which were adopted from Fetscherin and Stephano (2015). Respondents who did not travel to another country for medical reasons were eliminated. 541 responses were used for further analysis. 105 responses were eliminated because of not passing a validity check.

From the descriptive statistics, it can be concluded that nearly 60% of respondents were males who travelled abroad for medical treatment and 24% were females. With 48% of the respondents in the age group 25-34 as well as 35% of the respondents having income levels below U.S. \$40,000, in the case of this particular sample of data, respondents funded their own treatment abroad because they were young and uninsured/underinsured. As per the survey responses, a large percentage has travelled to India (40.1%) followed by China (15.1%), Thailand (13.1%), Mexico (4.4%), and

Turkey (3.75). From the descriptive statistics, it can be concluded that medical tourism in case of this sample is diasporic, short distance, and cross-border (Connell, 2013; Horton & Cole, 2011; Bergmark, Barr & Garcia, 2008). In other category, few of the actual medical tourists had chosen other destinations in South America, Asia, and Eastern Europe. Moreover, all the five countries previously mentioned are also attractive tourism destinations, providing an affordable quality of allopathy and alternative medicine (Kanittinsuttitong, 2015; Nutworadee, 2015; Heung & Kucukusta, 2013; Crooks et al., 2011; Runnels & Turner, 2011; Karuppan & Karuppan, 2011; Brotman, 2010).

The findings from this study will first inform potential U.S. medical tourists from the demand-side what to look for when choosing a destination and hospital for medical treatment. This research will assist health policy makers from the supply-side, such as governments, destination managers, and hospitals, to improve the quality of tourism facilities and destination attractions as well as medical treatment and facilities, in order to be competitive in the global trade of healthcare services. With the rejection of the Obama-care bill in 2017, there will be an increase in out-bound medical travel from the U.S. Middle-class U.S. citizens who are uninsured or underinsured and the diasporic U.S. population will travel cross-border to Latin American countries like Mexico or to other countries for medical treatment/surgery.

In the future, this study can be replicated for medical tourists from Canada, UK, and other developed countries to popular medical tourism destinations in developing countries, along with identifying the types of medical treatment (e.g. cosmetic, dental, hip/knee replacement, reproductive, or cardiac) and reasons for travel for these treatments based on push factors (domestic health policy) and pull factors. Similarly, one can also explore why people prefer a particular country (for example, India) than the other countries. Overall, this research has empirically contributed to the literature on medical tourism, in particular for host countries to maintain high ethical and regulatory standard of medical tourism healthcare quality and tourism facilities for patients as medical tourists.

**Keywords:** medical-tourism, outbound, USA, cost, healthcare-quality, destination

## References

- Bergmark, R., Barr, D. and Garcia, R. (2008), Mexican immigrants in the US, living far from the border may return to Mexico for health services, *Journal of Immigrants and Minority Health*, Vol.12, pp.610-614.
- Bies, W. and Zacharia, L. (2007), Medical Tourism: Outsourcing Surgery, *Mathematical and Computer Modelling*, Vol.46, pp.1144-1159.
- Bookman, M.Z. and Bookman, K.R. (2007), *Medical Tourism in Developing Countries*, Palgrave Macmillan, New York.
- Brotman, B.A. (2010), Medical Tourism Private Hospitals: Focus India, *Journal of Health Care Finance*, Vol.37 No.1, pp.45-50.
- Carrera, P.M. and Bridges, J.F.P. (2006), Globalisation and healthcare: understanding health and medical tourism, *Expert Review of Pharmacoeconomics & Outcomes Research*, Vol.7 No1, pp.447-445.
- Connell, J. (2006), Medical tourism: Sea, sun, sand and ... surgery. *Tourism Management*, Vol.26 No.6, pp.1093-1100
- Connell, J. (2013), Contemporary medical tourism: conceptualisation, culture and commodification. *Tourism Management*, Vol.34, pp.1-13.
- Connell, J. (2015), From medical tourism to transnational health care? An epilogue for the future, *Social Science & Medicine*, Vol.124, pp.398-401.



- Crozier, G.K. and Martin, D. (2012), How to address the ethics of reproductive travel to developing countries: A comparison of national self-sufficiency and regulated market approaches, *Developing World Bioethics*, Vol.12 No.1, pp.45-54.
- Crooks, V.A., Turner, L., Snyder, J., Johnston, R. and Kingsbury, P. (2011), Promoting medical tourism in India: Messages, images, and the marketing of international patient travel, *Social Science & Medicine* Vol.72, pp.726-732.
- Gan, L.L. and Frederick, J.R. (2011), Medical tourism facilitators: Patterns of service differentiation, *Journal of Vacation Marketing*, Vol.17 No.3, pp.165-183.
- Guiry, M., Scott, J.J. & Vequist, D.G. (2013), Experienced and potential medical tourists' service quality expectations. *International Journal of Healthcare Quality Assurance*, Vol. 26 No.5, pp.433-446.
- Heung, V., Kucukusta, D. and Song, H. (2011), Medical Tourism Development in Hong
- Horton, S. and Cole, S. (2011), Medical returns: seeking health care in Mexico. *Social Science and Medicine*, Vol.72, pp. 1846-1852.
- Jones, C.A. and Keith, L.G. (2006), Medical tourism and reproductive outsourcing: the dawning of a new paradigm for healthcare, *International Journal Fertility Women's Medicine*, Vol.5, pp. 251-255.
- JCI. (2017), Joint Commission International Accreditation Standards for Hospital, [www.jointcommissioninternational.org/about-jci/jci-accredited](http://www.jointcommissioninternational.org/about-jci/jci-accredited). (accessed 1 May 2017).
- Karuppan, C.M. and Karuppan, M. (2011), Who are the medical travellers and what do they want?: A qualitative study, *Health Marketing Quarterly*, Vol.28 No.2, pp.116-132.
- Kanittinsuttitong, N. (2015), Motivation and Decision on Medical Tourism Service in Thailand, *ASEAN Journal of Management & Innovation*, 24-36.
- MacReady, N. (2007), Developing Countries Court Medical Tourists, *Lancet*, Vol. 369, pp. 1849-1850.
- Manaf, N.H.A., Hussain, H., Kassim, P.N.J., Alavi, R. and Dahari, Z. (2015), Medical Tourism Service Quality: finally some empirical findings, *Total Quality Management & Business Excellence*, Vol.26 No.9-10, pp.1017-1028.
- Medhekar, A., Wong, H.Y. and Hall, J. (2014a), Innovation in Medical Tourism Services Marketing: A case of India, in Goyal, A. (Ed.) *Innovations in Services Marketing and Management: Strategies for Emerging Economies*, IGI Global Publishing, USA, Chapter 3, pp.49-66.
- Mehrotra, A., Epstein, A. and Rosenthal, M. (2006), Do integrated groups provide higher qualities medical care than individual practice associations?, *Annals of Internal Medicine*, Vol.145 No.11, pp. 826-833.
- Noree, T., Hanefeld, J. and Smith R. (2014), UK medical tourists in Thailand: they are not who you think they are, *Globalisation and Health*, Vol.10 No.29, pp.1-7.
- Nutworadee, K. (2015), Motivation and Decision on Medical Tourism Service in Thailand, *ASEAN Journal of Management & Innovation*, Vol.2 No.2, pp.24-36.
- Runnels, V. and Turner, L. (2011), Bioethics and transnational medical travel: India, 'medical tourism', and the globalisation of healthcare, *Indian Journal of Medical Ethics*, Vol.8 No.1, pp. 42-44.
- Smith, P. and Forgione, D. (2008), Global Outsourcing of Healthcare: A Medical Tourism Decision Model, *Journal of Information Technology Case and Application Research*, Vol.9 No.3, pp.19-30.
- Smith, R, D., Chanda, R. and Tangcharoensathien, V. (2009), Trade in Health-related services, *Lancet*, Vol. 373, pp. 593-601.
- Turner, L. (2007), First World Healthcare at Third World Prices: Globalisation, Bioethics and Medical Tourism, *BioSocieties*, Vol.2, pp.303-325
- Turner, L. (2010), Medical tourism and the global market place in health services: US patients, international hospitals and search for affordable healthcare. *International Journal of Health Services*, Vol.40 No.3, pp.443-467.
- Turner, L. (2013), Transnational medical travel: ethical dimensions of global healthcare, *Cambridge Quarterly of Healthcare Ethics*, Vol.22, pp.170-180.
- Whittaker, A. (2010), Challenges of medical travel to global regulation: a case study of reproductive travel in Asia, *Global Social Policy*, Vol.10, pp.396-415.
- Whittaker, A. and Chee, H.L. (2015), Perceptions of an international hospital in Thailand by medical travel patient: Cross-cultural tensions in a transnational space. *Social Science and Medicine*, Vol.124, pp.290-297.
- Woodman, J. (2015), *Patients Beyond Borders: Everybody's Guide to Affordable, World-Class Medical Travel*, Edition 3, Elsevier Publishing, USA.

# *Technology, E-Business & Social Media*

# Investigating the Impact Factors to Influence Online Room Rebooking Intentions in Taiwan

Tsong-Zen Liu<sup>1</sup>, Tai-Yi Huang<sup>2</sup>, and Hui-Hsin Kuo<sup>1</sup>

<sup>1</sup>The College of Hospitality  
National Kaohsiung University of Hospitality and Tourism, Taiwan  
<sup>2</sup>The College of Information  
University of North Texas, Denton, United State

## Abstract

Amongst various online information sources, third party booking websites are becoming increasingly important. Third party booking websites are applications of technology for customers in booking restaurants, accommodation and flights online. Examples of third party booking websites are Hotwire.com, Expedia.com, Orbitz.com and Hotels.com. These reservation intermediaries enable hoteliers to sell products directly to customers and reach a wide range of consumers in a fast and inexpensive manner (Morosan & Jeong, 2008). They use innovative technology to narrow down information sources according to customers' search preferences and make the planning and booking processes more effectively and efficiently. Furthermore, a range of IT-enabled institutional mechanisms (e.g., feedback mechanisms, third-party escrow services, and credit card guarantees) are used to increase buyers' trust (Hong & Cho, 2011) and help consumers to make appropriate purchase decisions (Ye, Law, Gu, & Chen, 2011). As a result, advertising on the third party hotel room reservation websites may be a wise choice for hoteliers (Morosan & Jeong, 2008). Therefore, there is an urgent need for academicians and practitioners to understand important factors influencing customers' rebooking intentions via third party websites. Customers use to gather lodging information and make room reservation from multi-channels (online and offline) today because of the rise of the internet-based hotel room booking technology. Hence, having a better understanding of customers' accommodation online and offline booking channels and factors affecting their booking intentions is essential for hoteliers. This paper aims to understand the impact factors which can influence the online customers' rebooking intentions in Taiwan via third party booking websites when conducting multi-channel transactions. Three dimensions were derived by factor analysis, namely: website trust, online brand image and offline brand image. In order to reach online customers, Internet survey and snow-ball sampling at Facebook were conducted to this research. The results indicate that all the three constructs have positive impacts on customers' online booking intentions and website trust is more important factor than others. In addition, customers with higher education level and middle monthly income have significant different higher online room booking intentions. Results of this study will help hoteliers distribute hotel products more effectively.

**Keywords:** multi-channel, online booking intention, online brand image, offline brand image, third party booking website, website trust

## References

- Aiken, K. D. & Boush, D. M. (2006). Trustmarks, objective-source ratings, and implied investments in advertising: investigating online trust and the context-specific nature of internet signals. *Journal of the Academy of Marketing Science*, 34(3), 308-323.

- Belanger, F., Hiller, J. S. & Smith, W. J. (2002). Trustworthiness in electronic commerce: the role of privacy, security, and site attributes. *The Journal of Strategic Information Systems*, 11(3), 245-270.
- Casaló, L. V., Flavián, C. & Guinaliú, M. (2007). The influence of satisfaction, perceived reputation and trust on a consumer's commitment to a website. *Journal of Marketing Communications*, 13(1), 1-17.
- Chen, C. C., Schwartz, Z. & Vargas, P. (2011). The search for the best deal: How hotel cancellation policies affect the search and booking decisions of deal-seeking customers. *International Journal of Hospitality Management*, 30(1), 129-135.
- Hong, I. B., & Cho, H. (2011). The impact of consumer trust on attitudinal loyalty and purchase intentions in B2C e-marketplaces: Intermediary trust vs. seller trust. *International Journal of Information Management*, 31(5), 469-479.
- Huang, R. & Sarigöllü, E. (2012). How brand awareness relates to market outcome, brand equity, and the marketing mix. *Journal of Business Research*, 65(1), 92-99.
- Jøsang, A., Ismail, R. & Boyd, C. (2007). A survey of trust and reputation systems for online service provision. *Decision Support Systems*, 43(2), 618-644.
- Jing, X. & Chan, A. (2010). A conceptual framework of hotel experience and customer-based brand equity: some research questions and implications. *International Journal of Contemporary Hospitality Management*, 22(2), 174-193.
- Kandampully, J. & Suhartanto, D. (2000). Customer loyalty in the hotel industry: the role of customer satisfaction and image. *International Journal of Contemporary Hospitality Management*, 12(6), 346-351.
- Kim, W. G., & Kim, D. J. (2004). Factors affecting online hotel reservation intentions between online and non-online customers. *International Journal of Hospitality Management*, 23(4), 381-395.
- Kwon, W. S. & Lennon, S. J. (2009a). What induces online loyalty? Online versus offline brand images. *Journal of Business Research*, 62(5), 557-564.
- Kwon, W. S. & Lennon, S. J. (2009b). Reciprocal effects between multichannel retailers offline and online brand images. *Journal of Retailing*, 85(3), 376-390.
- Lee, H. A., Law, R., & Murphy, J. (2011). Helpful reviewers in TripAdvisor, an online travel community. *Journal of Travel and Tourism Marketing*, 28(7), 675-688
- McKnight, D. H. & Chervany, N. L. (2002). What trust means in e-commerce customer relationships: an interdisciplinary conceptual typology. *International journal of Electronic Commerce*, 6(2), 35-60.
- Morosan, C. & Jeong, M. (2008). Users perceptions of two types of hotel reservation Web sites. *International Journal of Hospitality Management*, 27(2), 284-292.
- O'Neill, J. W. & Mattila, A. S. (2010). Hotel brand strategy. *Cornell Hospitality Quarterly*, 51(1), 27-34.
- Ross, C., Orr, E. S., Sisic, M., Arseneault, J. M., Simmering, M. G. & Orr, R. R. (2009). Personality and motivations associated with Facebook use. *Computers in Human Behavior*, 25(2), 578-586.
- Schwartz, Z. (2008). Time, Price, and Advanced Booking of Hotel Rooms. *International Journal of Hospitality and Tourism Administration*, 9(2), 128-146.
- So, K. K. F. & King, C. (2010). "When experience matters": building and measuring hotel brand equity: The customers perspective. *International Journal of Contemporary Hospitality Management*, 22(5), 589-608.
- Sparks, B. A. & Browning, V. (2011). The impact of online reviews on hotel booking intentions and perception of trust. *Tourism Management*, 32(6), 1310-1323.
- Wong, J. & Law, R. (2005). Analysing the intentions to purchase on hotel websites: a study of travelers to Hong Kong. *International Journal of Hospitality Management*, 24(3), 311-329.
- Ye, Q., Law, R., Gu, B., & Chen, W. (2011). The influence of user-generated content on traveler behavior: An empirical investigation on the effects of e-word-of-mouth to hotel online bookings. *Computers in Human Behavior*, 27(2), 634-639.

# The 5th Science & Technology Foresight in South Korea: Discovering Future Technologies to Solve Major Issues of Future Society

Jonghwa Park

Korea Institute of Science & Technology Evaluation and Planning (KISTEP), South Korea

## Abstract

### Introduction

It is becoming more and more important to establish and implement science and technology-related policies to predict the future uncertainties that will arise from globalization and informatization. The need for strategic science and technology planning to achieve the development of science and technology with limited resources is increasing. To accomplish this, major countries around the world have been carrying out national science and technology forecasting activities in order to analyze the demand for future change, establish strategic technology planning, and set the direction for research and development activities.

Since 1994, Korea has been engaged in its Science and Technology Foresight project on a 5-year basis, and has been announcing its findings as part of its efforts to anticipate future changes in response to specific circumstances in the country. In 2012, the results of the 4th Science and Technology Foresight were reported and used in establishing the 3rd Master Plan for Science and Technology and other policies. The Science and Technology Foresight is meaningful in that it analyzes the recent changes in the environment, and derives the prospect and demand for future change of our society from a mid-term and long-term viewpoint. It is also leading the field of science and technology prediction in Korea by introducing a new forecasting methodology.

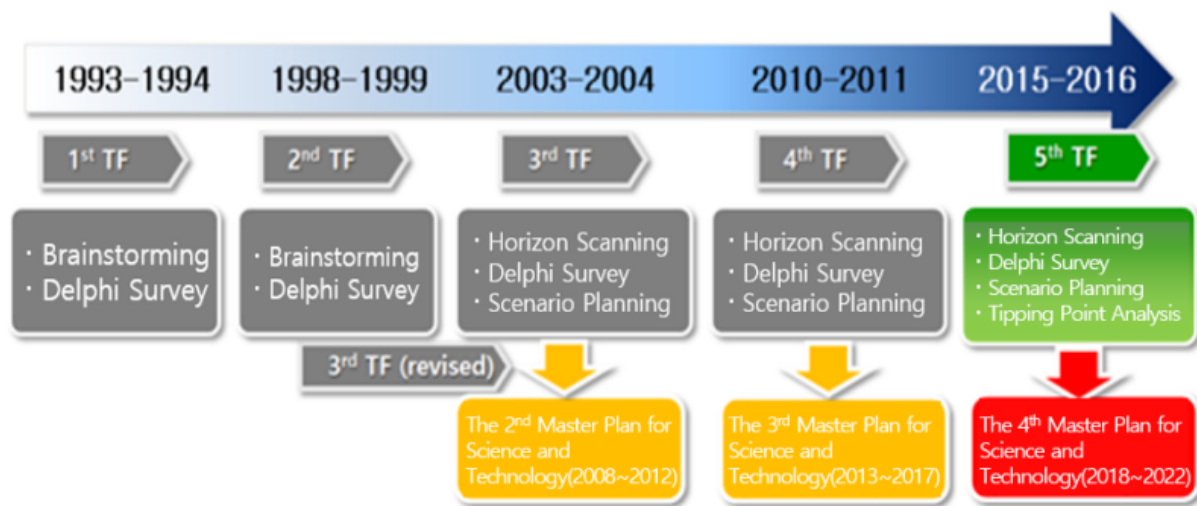

**Figure 1.** Progress of science and technology foresight

Currently, the Science and Technology Foresight is being carried out at the same interval as the Master Plan for Science and Technology based on Article 13 of the Framework Act on Science and Technology and Article 22 of the Enforcement Decree of the same Act.

## Objectives

The purpose of the 5th Science and Technology Foresight can be summarized by three broad objectives. The first is to predict the future society considering the internal and external environmental changes, and to predict and analyze the future technologies expected to appear throughout general fields of science and technology. In this research, we have derived future technologies that will emerge until 2040 based on the change of future social demand and the development of science and technology. The second is to contribute to the establishment of science and technology planning and policy that will strengthen the future responsiveness by reflecting the socio-economic demands of future society and the prospects for the development of science and technology. The result of the survey will provide basic data on policy establishment, such as timing of technology realization, importance, and way to realize the future technologies, and will be used to present the future technology information needed to establish the 4th Master Plan for Science and Technology (2018-2022). The third is to predict the tipping point of technology in terms of social spread, focusing on major innovative technologies related to the real lives of the people. We predicted the expected aspects of the rapid spread of a certain technology in the society and its expected timing, and together with this we have presented objectives for the realization of technology diffusion for future preparation.

The 5th Foresight has identified purpose-oriented future technologies to effectively cope with the major issues of the future society in order to improve the utility of the predicted result. The issues to be coped with were selected and analyzed with a particular focus on Korean society. In order to expand the application range of the results of the Foresight, we have diversified the composition of future technologies, improved the presentation method for the name of the future technology, and tried to secure the reliability and objectivity of the predicted survey results by introducing the scientific methodology. To this end, we expanded the Tech-Push future technologies derived through knowledge map analysis, increased the discovery of future technologies to be realized in the distant future by classifying the stage of analysis and prediction, and standardized the names of the future technologies in order to improve understanding and utilization of the derived technology.

## Prediction of the Future Society

Predictions of the future society have been made through a series of processes including analysis of future social trends and mega trends, the generation of trend-related issues, issue assessment and analysis and following deduction of major issues, as well as a process of deriving the needs from each major issue.



**Figure 2.** Process of future society prediction

To analyze future social trends and mega trends, we first analyzed the trends of future social change throughout the world (spatial axis) that our society should pay attention to in the mid-to-

long term perspective, until 2040 (time axis). Then, mega trends were derived by analyzing the connections between the trends. We analyzed future outlook reports from domestic and international sources, trend analysis, and websites published since the 4th Foresight (2011), and utilized STEEP (Social, Technological, Environmental, Economic and Political) analysis, through which we performed environmental scanning on each category and derived a clustering pattern among the trends. Finally, a total of 5 mega trends and 40 trends were derived.

Based on the results of the trend analysis, we have identified issues that are expected to have a significant impact on Korean society. Each issue was classified based on the expected timing of its impact, and as a result, we derived a total of 100 issues, 65 of which were expected to have a short-term impact (within 10 years) and 35 of which a long-term impact (within 11 to 25 years.) Among the issues raised, the ones that are to be particularly emphasized in Korean society were evaluated and selected as major issues, and finally 40 major issues (18 short-term issues, 14 short-to-mid term issues and 8 long-term issues) were derived.

Below is the graphical representation on the evaluation of Human Empowerment megatrend related issues. The horizontal axis represents the likelihood of the issue to occur in Korean society, the vertical axis represents the influence of the issue in Korean society, and the size of the circle represents the scientific and technological responsiveness.

Then, we grouped issues based on their correlation according to Big-Data based network analysis (data mining based on natural language analysis). Through this analysis, we derived six major issue groups including social infrastructure issues, ecosystem and environment friendliness issues, transportation and robotics issues, medical and life issues, manufacturing and convergence issues and information and communication issues.

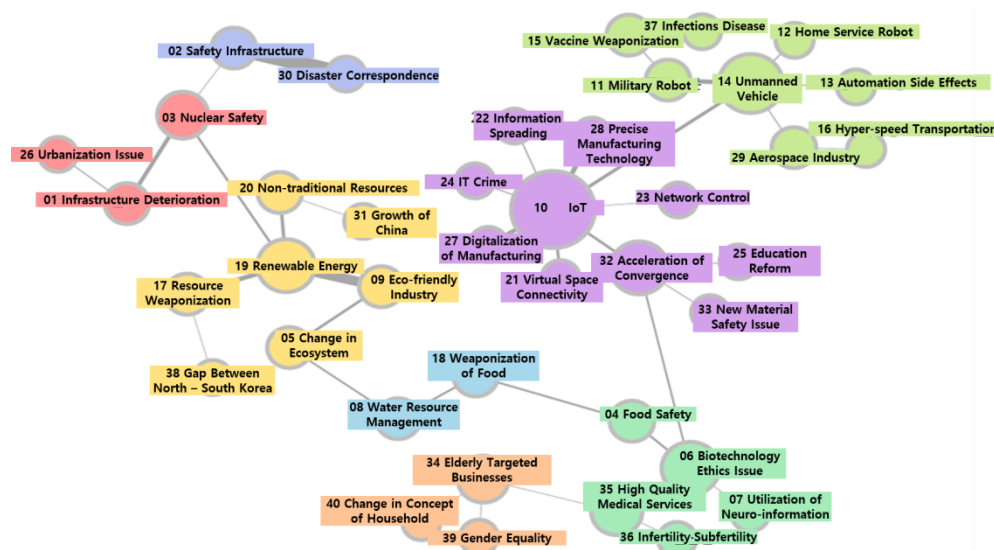

Figure 3. Deriving key connections in the issue network (2012-2015)

Needs specific to major issues were derived with the aim of setting up scientific and technological means to cope with the major issues. Based on an in-depth analysis of each major issue, we have presented the detailed socioeconomic demands of the future society in terms of scientific and technological responses.

Finally, in order to analyze the trends in science and technology development, we performed a time-series analysis on each research field to derive completely new technology and research fields or emerging research fields. The analysis also helped us to visualize the relationship and development flow between research fields. The Science Map was charted to be utilized for identifying Tech-Push type future technology candidates. The resulting knowledge map was used to derive future technology candidates through an interpretation and analysis process applied by the experts in the related technology field.

### *Identification of Future Technologies*

For this Foresight, we have defined future technologies as concrete technologies (products, services, systems, etc.) that will be technically realized by 2040 and are likely to have a significant impact on science, technology, society and economy in the Republic of Korea. In the 5th Foresight, we have standardized the presented name and description of the technologies to improve the understanding and utilization of the results, whereas in the 4th Foresight each technology was given a unique name. The names of future technologies have been simplified, with an emphasis placed on core keywords in order to make it easier to understand, while future technology descriptions have been written in more detail. In addition, as the level of future technology has been upgraded, the number of future technologies to be finally derived also has been adjusted to about 50% that of the list in the 4th Foresight.

The Future Technology List (draft) was determined through a process of deriving future technology candidates and revising and adjusting them. The candidates for the list were selected by reviewing the results of analysis and interpretation of a needs and knowledge map based on the six future issue groups identified through the analysis of the major issue network.

Verification on the similarities and duplications, review on appropriateness as future technologies, adjustment of the level of technology, supplementation on the name and the description of the technology have been implemented on derived candidate technologies, and through this process we have arranged, amended and adjusted list of future technology candidates, and the executive committee reviewed this list in order to confirm the future technology list. Through this process, a total of 267 future technologies expected to emerge by 2040 were derived based on future social needs, to solve major issues and development needs in science and technology.

In this presentation, we will introduce background, purpose and progress of S&T Foresight performed by our institute, KISTEP. Each process of 5th S&T Foresight and what has been improved compared to prior foresight results will be presented. In addition we will also introduce following process to realize the 267 future technologies which were done on 2017.

**Keywords:** technology foresight, future technologies, future society prediction

### **References**

- JiHo Hwang, YoungJun Kim, Soekho Son, Jongmin Han, (2011) "Technology foresight in Korea: a review of recent government exercises", *Competitiveness Review: An International Business Journal*, Vol. 21 Issue: 5, pp.418-427
- Moonjung Choi, Han-Lim Choi, Heyoung Yang, (2014) "Procedural characteristics of the 4th Korean technology foresight", *Foresight*, Vol. 16 Issue: 3, pp.198-209



Seung-Ryong Lee, Jonghwa Park, Moonjung Choi, (2017) "The 5th Korean Technology Foresight", KISTEP, pp.1-453,  
Jonghwa Park, Sun-Mi Ji, (2017) "The 5th science & technology foresight in South Korea: Discovering Future Technologies to Solve Major Issues of Future Society", KISTEP InI, Vol. 20, pp.33-49

### **Acknowledgements**

This work was supported by KISTEP Agency-specific program, project No. AF16010.

# Collective Intelligence and Decision Making: Method and Its Application in Preliminary Feasibility Analysis of Public R&D Program in Korea

Sung-Ho Cho

Korea Institute of Science & Technology Evaluation and Planning (KISTEP), Republic of Korea

## Abstract

As the size of investment in R & D investment has increased, the awareness of the efficiency of limited government fiscal enforcement has also increased, and a preliminary feasibility study has been conducted as a system to verify the feasibility of projects from the planning stage before large-scale financial investment. The preliminary feasibility study system examines technically, politically and economically feasibility of the R & D project that is planning large-scale government expenditure in three dimensions and derives comprehensive judgment by using the analytical hierarchical process (AHP) . Depending on the aggregate score of the AHP analysis, a single conclusion is presented to the fiscal authority or stakeholder in the form of binary decision making for the implementation or non-execution of the project. Therefore, not only the objectivity and fairness of the survey process and analysis method, but also the reliability of the survey results are the most important foundation and target for the operation of the system. AHP does not involve statistical or probabilistic concepts of aggregate ratings analyzed because it derives alternative conclusions on project implementation alternatives and non-project alternatives based on an aggregate rating of 0.5, meaning theoretically neutral. However, even if a plurality of experts participates in the AHP, the question of whether the opinion can be viewed as reflecting opinions of experts in the relevant field requires a statistical approach. In particular, when there is a conflict between the evaluators, It is necessary to consider aspects that are difficult to make an informed decision. In this paper, we discuss a method for verifying the reliability of the AHP comprehensive rating when choosing a single alternative, and a method for reducing judgment errors from a statistical point of view.

## Introduction

The preliminary feasibility analysis refers to the preliminary validation and evaluation conducted by the Minister of Strategy and Finance in order to establish a budgeting and fund management plan for large-scale new projects pursuant to Article 38 of the 「National Finance Act」 and Article 13 of the Enforcement Decree of the same Act in Republic of Korea. The preliminary feasibility analysis is aimed at preventing the waste of budget and contributing to the efficiency of financial management by making transparent and fair decision based on priority of new investment of financial business through objective and neutral investigation of the feasibility of large-scale financial programs (or projects). In other words, the preliminary feasibility analysis is a process of reviewing the financial business in advance for efficient allocation of resources under the constraints of finite government budgets. Through this, it is possible to provide objective and neutral information related to the project promotion, such as feasibility of the project and review of alternatives, in advance for the business plan established by each department.



**Figure 4.** Legal basis and guidelines of preliminary feasibility analysis in Republic of Korea

The preliminary feasibility analysis covers new construction projects, information projects, and national research and development projects with a total project cost of over about 500 million dollars and government's financial support of more than about 300 million dollars. The purpose of the preliminary feasibility study for national R & D projects is to comprehensively assess the feasibility of project implementation. To do this, we conduct a multi-dimensional analysis (the analysis of science and technology feasibility, policy feasibility and economic feasibility) and provide a qualitative conclusion. To quantify it, we use eventually the multi - criteria decision methodology called AHP. In the preliminary feasibility analysis in Korea, the analytical hierarchical process (AHP) is used for decision making. This technique is recognized as useful in that it decomposes and structures the problem in a way similar to human thinking, and it derives the results in a quantitative form by measuring the relative importance of the evaluation factors and the preferences of the alternatives on a scale of ratios. Despite the simple application procedure, various techniques used in selecting scales, calculating weights, and sensitivity analysis are evaluated theoretically in terms of utilizing the methods adopted through empirical analysis and rigorous mathematical verification.

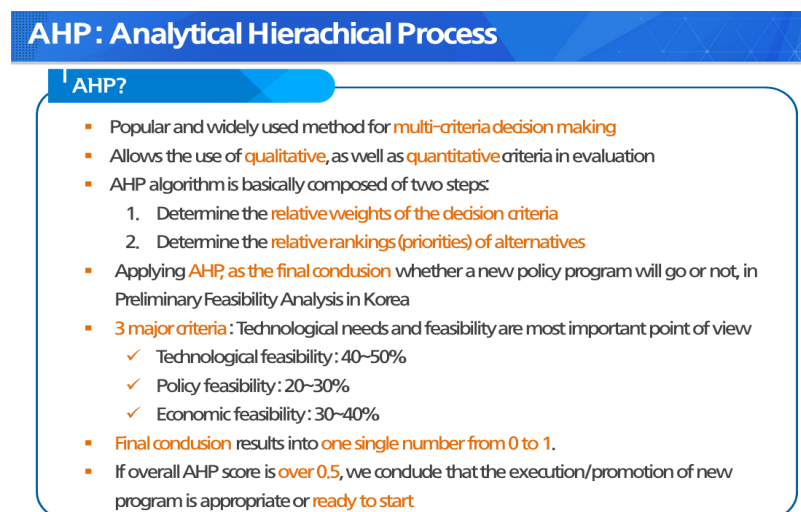

**Figure 5.** Main features and application of AHP in preliminary feasibility analysis in R&D sector

## Objectives

The result of the AHP analysis is designed between 0 and 1. 0.5 that is center point is the basis of decision. If it is 0.5 or more, the program plan is judged to be valid(feasible to execute). If it is 0.5 or less, the program plan is judged that it is not valid(not feasible to execute). Therefore, the AHP conclusion in the preliminary feasibility analysis is characterized by binary decision making. Such a binary decision-making approach is aimed at deciding whether or not the final outcome of the preliminary feasibility study will allocate the budget for the project. That is, there is no statistical or probabilistic concept. However, even if several experts participate in the AHP, a statistical approach is needed to determine whether the opinion can be viewed as reflecting opinions of experts in the various kinds of a field. Particularly, there may be controversy about the decision-making (project execution or non-execution) if the opinions are divided and the final result is close to neutral. Therefore, in the case of special situations such as the following, a careful approach is needed to secure confidence in decision making and to reduce judgment errors. First, there is no agreement between referees(evaluators). Referees' opinions would be divided into various ratios, and even if the overall AHP score is located in over or under of 0.5, it is sometimes difficult to decide whether or not to implement the project in a situation where there is no consensus among evaluators. Second, If the score is not 0.5, but very close, there may be a chance of a stochastic error. In these cases, it is difficult to make a decision, and it is necessary to examine the possibility of a stochastic error.

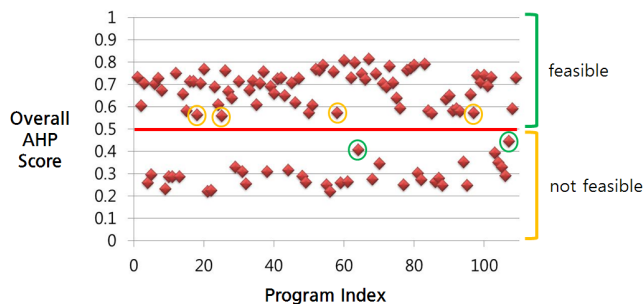

0.45 : 0.56 ?  
True or False?  
How Different?  
How Accurate?

Figure 6. Binary decision making

A common question when deciding whether to implement a project based on the AHP overall score is that "the difference between the AHP overall score of 0.51 and 0.49 is significant enough to make an alternative judgment. Despite the fact that it is not possible to confidently answer this question, we are forced to make binary decisions(feasible or nor feasible). For this reason, we eventually define the gray zone as an interval that requires careful decision making. In the case of the AHP score located in gray zone, careful judgement is needed in final decision making.

### Problem Definition and Introduction of Gray Zone

If the opinions of AHP referees agree perfectly, that is, if all of them choose the same alternative, the reliability of the AHP comprehensive rating is not required to be statistically examined. However, if the referees' opinions are divided, it is necessary to make efforts to form consensus through mutual discussions, or to examine whether the overall AHP scores have statistically

significant differences. Although explanations and discussions on the basis of their evaluation can be effective in narrowing the gap in opinion, it is possible that there may be cases in which it is difficult to obtain complete consensus. Even if each referee's AHP score is divided into 'feasible(0.5 or more)' and 'non feasible(0.5 or less)', it is difficult to make a firm decision in the situation where there is no consensus among the evaluators. In addition, if an referee has a strong negative opinion when the others mark positive, the overall AHP score might be located between 0 and 0.5. In these special and sensitive circumstances, AHP referees have difficulty in making decisions. Based on these reasons, the guidelines for preliminary feasibility studies require a more conservative approach to defining alternative grades as a gray zone where a certain level of overall AHP score is required for careful decision making.

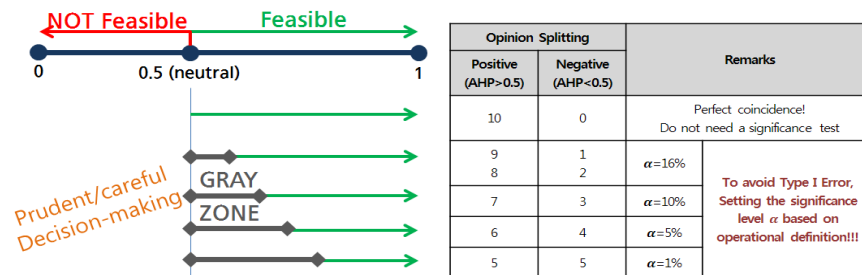

Figure 7. Schematic explanation of GRAY ZONE for careful decision-making

In this paper, we analyze the reliability of AHP's overall rating, which quantifies whether it is feasible before the implementation of a new project, and the factors that cause it to fail. AHP The purpose of this study is to examine the risk factors at the practical level for recognizing changes in the institutional environment where the number of AHP evaluators is increasing and for raising the reliability of the preliminary questionnaire survey for the purpose of alternative decision making, respectively. The increase in the number of evaluators has the advantage of collecting collective intelligence, but it can also result in the possibility of conflict of opinion in various interests. It is also necessary to recognize that the preliminary feasibility study, in which the form of the survey results should be selected as one of the alternatives for enforcement and non-enforcement, increases the ambiguity of conclusions. However, it is expected that reliable decision making will be helpful if we take into account the statistical significance intervals according to the number of opinion conflict cases and the significance level that minimizes the possibility of error occurrence.

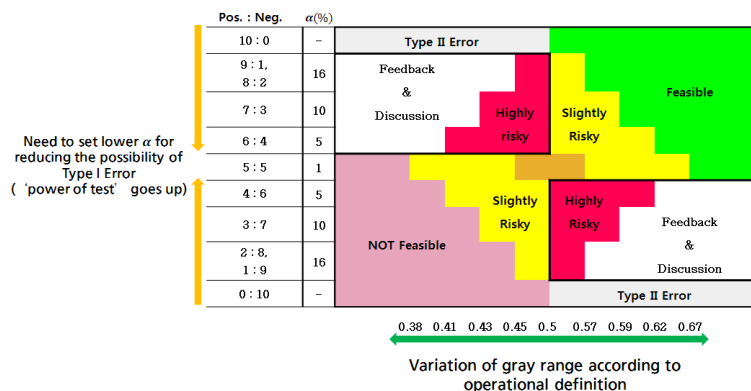

Figure 8. Decision-Making Chart with respect to opinion Splitting & AHP overall score

## Concluding Remarks

In this paper, The reliability of the AHP score and the causes of error were analyzed. In order to increase the reliability of the decision making based on AHP, the risk factors at the practical level were reviewed and measures were suggested to avoid them. The increase in the number of referees has the advantage of applying collective intelligence, but it can also result in the possibility of conflict of opinion in various interests. It is also necessary to recognize that the preliminary feasibility analysis, in which the form of the final result should be selected into just single result such as 'feasible to execute' or 'not feasible'. It is expected that reliable statistical significance intervals according to the number of conflicts of opinions and the significance level that minimizes the possibility of error occurrence will help to make highly reliable decisions.

**Keywords:** preliminary feasibility analysis, government funded program, AHP, analytical hierarchical process, significance test, type I/II error, gray zone

## References

- Thomas L. Saaty, Luis G. Vargas(2001), Models, Methods, Concepts & Applications of the Analytic Hierarchy Process, Kluwer Academic Publishers.
- Evangelos Triantaphyllou, Stuart H. Mann(1995), "Using the Analytic Hierarchy Process for Decision Making in Engineering Applications: Some Challenges", International Journal of Industrial Engineering: Applications and Practice, Vol. 2, No. 1, pp. 35-44.
- Ryu(2010), Statistics, Part. 5, Bupmoonsa

## Acknowledgements

This work was supported by KISTEP Agency-specific program, project No. BH16010.

# The Power of Engagement: Uncovering Social Media's Return on Investment

Elizabeth Yost, Tingting Zhang, and Ruoxi Qi

The Rosen College of Hospitality Management  
University of Central Florida, United States

## Abstract

Over the past decade, social media marketing has increasingly grown as one of the most influential digital marketing techniques (Quach, 2017) for all types of companies selling various products and services (Chan & Guillet, 2011). The easy access and simple use of social media platforms provide an innovative yet relatively inexpensive way to connect and engage with targeted customers, which has inspired more companies to develop comprehensive social media strategies (Fischer & Reuber, 2011; Mangold & Faulds, 2009).

However, while most sales and marketing teams agree that there is a correlation to improved sales and profit margin figures when products are launched through social media channels (Kim & Ko, 2012), it can be difficult to quantify and measure the exact impact (McCann & Barlow, 2015). In fact, while the level of sophistication of social media marketing techniques has continued to improve, identifying and measuring the ROI of social media ranks is the priority challenge for social media marketers, with 61.1% citing this as their top one challenge ("The state of social marketing 2017 annual report", 2017). Thus, quantifying the return on investment of using social media channels to promote products and services presents a timely research problem for the hospitality and related retail industry.

Therefore, the purpose of this study is to uncover the power of social media on firm performance. Specifically, two research questions are under investigation: (1) how much sales increase is generated by the social media engagement? (2) what are the critical formula for a highly engaging social media post? To answer the research questions, two studies are conducted: Study 1. a firm performance analysis is conducted to quantify the impact of social media engagement on the sales revenue. Study 2. text mining is performed on the unstructured social media posts to identify the critical components of a highly engaging social media post.

### *Study 1: Probit Model*

For the objective of increasing sales, this study will examine the impact of released new products via social media channels (Facebook, Twitter and Yammer) on direct sales figures based on levels of engagement. This study will utilize a probit regression model to estimate the probability that social media contributed to the sale based on the defined social media release date, level of engagement and the subsequent sale amount.

### *Study 2: Text mining*

For the objective of uncovering the attributes of engagement, text mining procedures will explore and identify the hidden but useful patterns, trends or rules from the engagement data and then create interpretation or models to explain questions and discover new knowledge (Park, Jang & Ok, 2016; Xu & Li, 2016).

This study will present timely research for organizations who are interested in learning whether or not the employee investment is worth engagement with social media channels in order to promote or sell new products and services. While it is hard to provide a “one size fits all” social media practice for all organizations, this could provide insight for companies within the same industry sector looking to increase sales goals. Social media is often a lead to a sale, but perhaps this study may offer an opportunity to quantify the impact of such leads.

**Keywords:** social media, return on investment, text mining, social media engagement, sales, regression analysis

## References

- Chan, N. L., & Guillet, B. D. (2011). Investigation of social media marketing: how does the hotel industry in Hong Kong perform in marketing on social media websites?. *Journal of Travel & Tourism Marketing*, 28(4), 345-368.
- Fischer, E., & Reuber, A. R. (2011). Social interaction via new social media: (How) can interactions on Twitter affect effectual thinking and behavior?. *Journal of Business Venturing*, 26(1), 1-18.
- Kim, A. J., & Ko, E. (2012). Do social media marketing activities enhance customer equity? An empirical study of luxury fashion brand. *Journal of Business Research*, 65(10), 1480-1486.
- Mangold, W. G., & Faulds, D. J. (2009). Social media: The new hybrid element of the promotion mix. *Business horizons*, 52(4), 357-365.
- McCann, M., & Barlow, A. (2015). Use and measurement of social media for SMEs. *Journal of*
- Park, S. B., Jang, J., & Ok, C. M. (2016). Analyzing Twitter to explore perceptions of Asian restaurants. *Journal of Hospitality and Tourism Technology*, 7(4), 405-422.
- Quach, J. (2017). Social media marketing in the hotel industry: trends and opportunities in 2017. Retrieved from <https://www.hvs.com/article/8049-social-media-marketing-in-the-hotel-industry-trends-and-opportunities-in-2017>
- The state of social marketing 2017 annual report. (2017). Retrieved from [https://get.simplymeasured.com/rs/135-YGJ-288/images/SM\\_StateOfSocial-2017.pdf](https://get.simplymeasured.com/rs/135-YGJ-288/images/SM_StateOfSocial-2017.pdf)
- Xu, X., & Li, Y. (2016). The antecedents of customer satisfaction and dissatisfaction toward various types of hotels: A text mining approach. *International journal of hospitality management*, 55, 57-69.



## **Advances in Global Business and Economics**

This book presents the proceedings of Global Conference on Business and Economics which was held during June 4-8, 2018 at the University of South Florida Sarasota-Manatee, Florida.

**ISBN 978-1-7321275-1-7**