

Experimental & Mathematical Modeling and Analysis of Piezoelectric Energy Harvesting With Dynamic Periodic Loading

Mohit Yadav, Dinesh Yadav, Surendra Kumar, Ramesh Kumar Garg, Deepak Chhabra

Abstract: In this research work, an experimental model is developed to apply the dynamic periodic load on piezoelectric material for energy harvesting. The proposed setup is analyzed to calculate the energy harvested with circular piezo-patch with end supported boundary conditions. Piezo patch is connected with full bridge rectifier circuit under dynamic loading condition to calculate the output of the system. The proposed setup consists of a force sensor, a printed circuit board (P.C.B.) with calibration circuit, a LCD display unit, a stepper motor, a suitable power source and a robust mechanism to apply the dynamic periodic load. The input dynamic load can be varied by varying the height of the piezo-patch. Mathematical modeling of the proposed system has also been developed and successfully validated with experimental results. It is observed that the proposed setup and mathematical modeling accurately apply varying dynamic load and able to calculate the output of the system.

Keywords: Experimental Setup, Mathematical Modeling, PCB, Force Sensor

I. INTRODUCTION

Adynamic load can be considered as live load acting on a structure or any object. Dynamic load on an object can be applied in various ways, like harmonic, impact, cyclic etc. Dynamic behaviour of system is a vital phenomenon in any field. For the simulation of aeroplanes and space vehicles in aerospace industry, engineers should understand the concept of dynamics. For controlling the vibration of devices mechanical engineers must learn the dynamics. For designing of structure, dynamics plays a vital role in civil engineering [1]. To identify the occurrence and location of damage within an existing structure during earthquakes, hurricanes, and strong winds the idea of structural dynamics is frequently used in civil engineering. To understand these features of loading it's very important to know concepts in dynamics of structures. Here we need to apply loading with varying magnitude in each observation. The value of load should not fluctuate within the individual observation [2]. The all above

Revised Manuscript Received on September 25, 2019

Mohit Yadav, Department of Applied Sciences, University Institute of Engineering & Technology, Maharshi Dayanand University Rohtak India. Email: mohitphd31@gmail.com.

Dinesh Yadav, Department of Mechanical Engineering, Deenbandhu Chhotu Ram University, Murthal, India. Email: dineshkoslia91@gmail.com

Dr. Surendra Kumar, Department of Applied Sciences, University Institute of Engineering & Technology, Maharshi Dayanand University Rohtak India. Email: skymathmdu@rediffmail.com.

Dr. Ramesh Kumar Garg, Department of Mechanical Engineering, Deenbandhu Chhotu Ram University, Murthal, India. Email: drkrgarg.me@dcrustm.org@gmail.com.

Dr. Deepak Chhabra, Department of Mechanical Engineering, University Institute of Engineering & Technology, Maharshi Dayanand University Rohtak, India. Email: deepaknit10@gmail.com.

stated conditions are fulfilled by designing a mechanism in which periodic dynamic load is applied. Piezo electric harvesting is a broad area of research, it mainly includes its application using fluid flow dynamism in closed [3] and open channel flow [4]. PEH system use fluid flow through nozzle for energy harvesting using single and double Piezo patches connected in series and parallel circuits. They show the relation between energy extracted with various parameters such as space between Piezo patch and fluid nozzle, no. of nozzles and angle through which the water jet impinges on PZT [5]. PZT patches are also used to simulate the tricky situations in electro dynamic shaker control and then amalgamate the shaker with different circuits which are based on hyper stability principle [6]. Plucking piezoelectric energy harvesters using non harmonic excitations are also designed with the help of the PEH support system [7]. The vehicle running on the road applies the dynamic load on the road, this dynamic load may be transformed into electrical energy using piezoelectric material, the amount of voltage depends on size and type of material under load profiles [8]. From the above study, we observe the various applications of the piezo-material elements under different process parameters and environment.

This study deals with experimental modelling and analysis of piezoelectric energy harvesting with dynamic loading system. A reciprocating type cylindrical source of dynamic impact load is created and connected with a rotating motor assembly. Designing of mechanism also consists of a sensor, printed circuit board (P.C.B.) and a suitable power source to run the mechanism. A piezo patch with full bridge rectifier circuit is also used to check the generated voltage under dynamic loading condition. The model creates the dynamic pressure on the piezoelectric material which converts this pressure into an AC electrical voltage which is converted in DC voltage using rectifier circuit and measured by multimeter. The output voltage produced due to the application of periodic dynamic load is plotted versus applied load. Mathematical modelling is used to validate the experimental model which results only a 2.837 percent.

A. Main Parts of the Mechanism

Dynamic load is applied to a body where time variant behavior is considered. A mechanism is look like a machine and sometimes it is the essential part of a machine. Here, the mechanism consists of several components like force sensor, printed circuit board, power source etc. The parts consisted of mechanism plays different-different roles and are used to make the dynamic action on the object. The main parts of a mechanism which can apply

dynamic load are as under:

- Force sensor
- Printed circuit board (P.C.B.)
- Power supply

A.1 Force sensor

Force sensors are highly durable that these can be used in various adverse conditions. These are used to measure force between two flat surfaces. In an electrical circuit, the Flexi force sensor acts as a force sensing resistor. This is shown in figure 1, in which all essential constructional features are shown. When the force is eradicating from force sensors, resistance will be increasing & vice versa. The device named Multimeter is used to measure the value of resistance. The dynamic load is applied on the stated surface under consideration. General applications in detection & measurement with force sensors are comparative, variation in applied load or force, Change of load w.r.t. Time, and Force threshold & generate proper exploits and contact & touch etc.

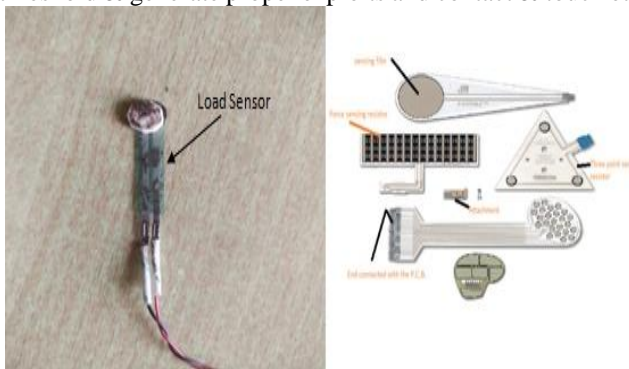

Figure 1. Constructional features of a force sensor

A.2 Printed Circuit Board

Printed Circuit Board are employed for shelter apparatus for making a circuit for firmness, ease of servicing & in context for internal connection. So P.C.B. can be defined as: This is a Bakelite sheet in which one side is employed by copper patterns with porous & from another side, leads of electronic apparatus are placed in the suitable holes & soldered. By this way electronic circuit is prepared by joining the leads of electronic apparatus and the schematic diagram is shown in figure 2. Copper wrapping is done on the boards by thrashing slim copper foil on the boards during remedial. The board is wrapped with copper whose thickness is about 2mm & weights about 30 mg per square foot [9]. Board materials are of two kinds one is based on Phenolic paper and another one is based on Glass epoxy. Wrapping of copper is done on both materials with the help of thin sheets. Wrapping of copper has been done, either on one side or on both sides in case of Printed circuit boards. Pasting has been done with the help of copper foils in both kind of boards. Size of boards is up to 2 meters in length and width of the board is between 1 to 5 meters. The thickness of the board lies between 1.4 to 1.8 mm ranges. The thickness of board, including copper is near to 0.2 mm.

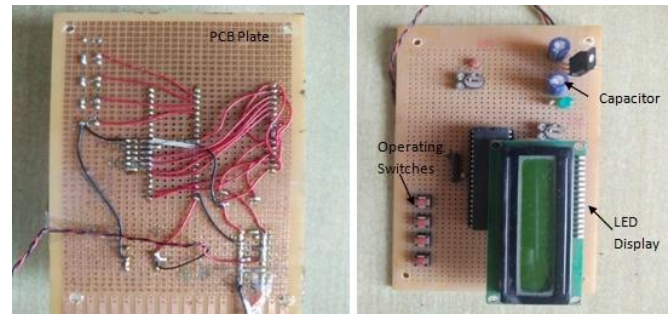

Figure 2. Design of printed circuit board (P.C.B.)

There are some introductory discussions, in course of printed circuit board drawing, such as width of lines or holes as per the apparatus. Then the P.C.B. sketch is drawn like rows, tracks, square as per the circuit figure by using enamel paint, plain nail polish or any other fluid which is resistant to acid. Arid the localized face in open air & when it is dried absolutely, the noticeable gap in P.C.B. can be pierced with the help of 1mm drill bit. In case of lack of lines due to spillage of paint, these can be detached by altercating with the help of a cutting edge by considering the dried paint. The paint on the pattern can be eradicated over P.C.B. & may be swabbed & dried. Place a coat of shiny surface to sustain the charm. Finally the P.C.B. is prepared for work.

A.3 Power Supply & Requirement

A 'power supply' is a crucial necessity in case of giving energy or to deliver energy in some form. The batteries of solid-state electronic tools can be removed by a battery eliminator & thus the tools may be performed by 230 volt A.C. mains as an alternative of the batteries. These days the application of power supply has become very much popular in the field of household appliances like transistors, cassette player, tape recorder, record player etc.

In India, accessibility of electrical energy is in the shape of alternating voltage to residences & industries. Electrical supply, possess a voltage of 220V for the 50 Hz's frequency, whereas in America, the voltage of 110V for the frequency of 60 Hz. A DC voltage is needed for satisfactory process of the majority of the electronic tools. For illustration, a DC supply required by a transistor radio for self operation. Usually it is supplied by batteries. Other than that, in place of dry cells, we can make use of a power supply. An AC voltage is converted into DC voltage by the use of a power source that eliminates the requirement of dry cells. At the present time, nearly every apparatus comprises a path that converts AC voltage of mains supply into DC voltage and this is all done by power source. Usually a power transformer is applied at the entrance of the power supply & rectifier follows this. The rectifier's output of the goes to a smoothing filter followed by a voltage regulator circuit. The important part of power supply is a rectifier circuit like heart for a human body. Rectification is the method of interpretation of a voltage into a specified single way. The rectifier is applicable as the component for rectification. During the +ve half cycles only, the rectifier allows current to flow by eliminating the fluctuation of the applied AC voltage. Therefore, effervescent Direct Current is attained. Additional filter circuits are employed to obtain smooth DC power

II. MODELING AND FUNCTIONING OF THE EXPERIMENTAL SETUP

The process of constructing the mechanism first starts with selecting a suitable base for resting the all components. It base is made up of wood and the stand is fabricated from mild steel material. Various channel sections are then welded together to attach the remaining components. A torque motor is attached to the vertical stand and from the other end it is connected with the reciprocating arm. The reciprocating arm as shown in the figure 3 is in cylindrical shape with and flat surface. This is done by the process of leveling. A printed circuit board is prepared on the copper base and is connected with the force sensor. Force sensor will read out the value of the load acting on the circular shaped foil. The object for which load calculation is to be calculated is connected with the force sensor. A general-purpose battery BF22 of 9 Volt is shown in figure 3 employed for the functioning of the sensor for reading purpose. By screw arrangement, the reciprocating arm is connected to a wooden wheel eccentrically. This wooden wheel is connected to the torque motor. Torque motor runs with the help of a power source of 230-volt A.C. Then the mechanism is ready to perform the experiment. The general attention is focused on the calibration of the reading of the force sensor. Figure 3 shows the Experimental Model for dynamic load.

In the designed mechanism, cyclic dynamic load with varying magnitude is applied to piece patch. This PZT Piezo patch is employed with three different boundary conditions, namely simply supported, circular supported and fixed supported as shown in below. Dynamic loading on PZT Piezo patch is recorded by a force sensor. This force sensor reads out the value of applied load in its rated unit. This unit is then calibrated with some suitable scale. It is seen that when the mechanical type of action like dynamic load is applied in Piezo patch, electricity is produced. The voltage is produced when the dynamic load is applied, which is measured by connecting a Multimeter to the circuit after passing through a rectifier circuit, i.e. full bridge rectifier.

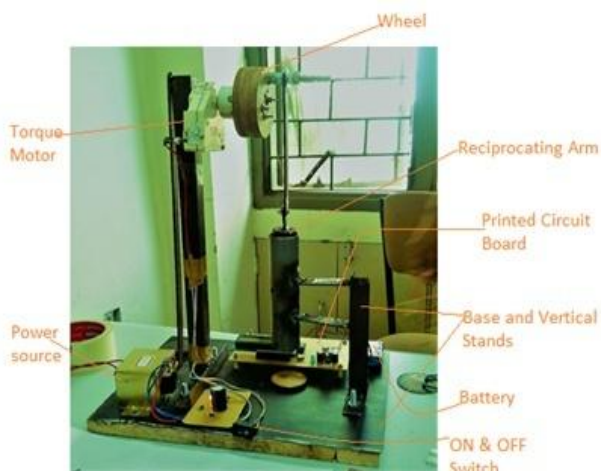

Figure 3. The Experimental Model for dynamic load

Piezoelectric effect is a special characteristic that permits material to produce electric power by converting mechanical energy into electrical energy and vice-versa. This attribute can be inherent existing non-piezoelectric equipments like ceramics and polymers. In 1817, Charles coulomb was the earliest human being who theorized direct piezoelectric phenomenon. After this Pierre and Jacque Curie, the two brothers initiated this concept and by seeing the crystal structure and behavior and their knowledge of

pyro-electricity they demonstrated the first piezoelectric phenomenon. They put weights on quartz crystal and observed that some commission is produced and the magnitude of this direction is proportional to the applied weight. Figure 4 shows the phenomenon of piezoelectric effect.

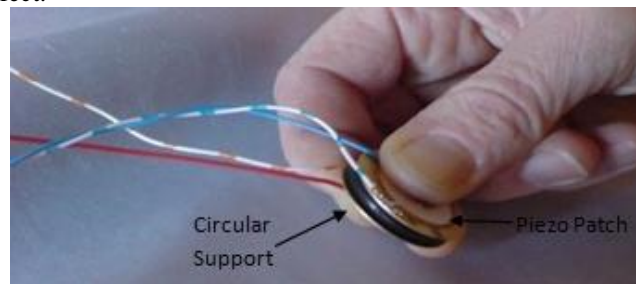

Figure 4. Piezoelectric Disk with circular support Generates Voltage under Deformation

After the discovery of direct piezoelectric effect Lippmann predicted about the converse effect of piezoelectricity that is a mechanical strain could be generated if electric charge is imply to a piezoelectric material. Piezoelectricity derived from the Greek word “Piezo” which means “to press” and “electricity” that bears the equal significance as the English word “electricity. Figure shows the direct and converse piezoelectric effect. Piezoelectric materials have intrinsic characteristic which make them attractive for various applications of micro devices. These are the member of ferroelectrics and their molecular structure is so oriented that an electric dipole is present. Random orientation of electric dipoles in simulated piezoelectric equipments does not display the piezoelectric phenomenon. When the temperature of an object is rises above a specific point, the Curie temperature and a strong electric field are imply through these materials, then their dipoles get reoriented in a direction relative to the direction of applied electric, this method is also known as poling. After poling the object is cool down, the orientation of dipoles is maintained and exhibit piezoelectric effect even after the removal or external electric field as shown in figure 5.

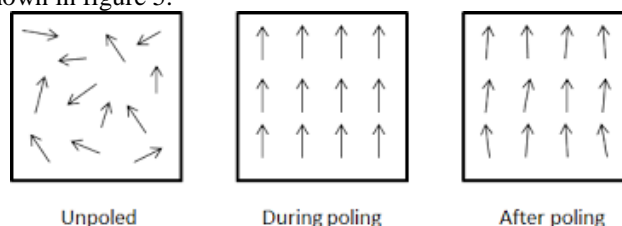

Figure 1. Alignments of Dipoles in a Piezoelectric Material

III. MATHEMATICAL MODELING OF DPEH SYSTEM

Harvesting of energy from a piezoelectric structure with the help of impact load includes the interactions of (i) impact load, (ii) piezoelectric patch and (iii) the electrical circuit [10-11]. As the dynamic load generates the charge within layers of piezoelectric consequently, mechanical strain is produced which is further used in rectifying circuit. These mutual interactions can be interpreted by equations of every subsystem [12].

It has been described in [13-14] if a force F is applied on the piezoelectric film having diameter D_P of piezoelectric patch, area is A having dielectric permittivity ϵ and electromechanical coupling coefficients K_{33} , then the voltage V_h (Volts) developed across the electrodes in the thickness direction is given by

$$V_h = \frac{K_{33}F}{\epsilon D_P} \quad (1)$$

IV. RESULT & DISCUSSION

A. Experimental Result Interpretation

Single piezoelectric patch full wave rectifier circuit is connected with circular supported Piezo patch is experimented as shown figure 6. The Piezo patch is provided with a circular boundary condition and is shown in figure 7. The numbers of strokes are increases the corresponding output voltage is also increases simultaneously. Load reading fluctuates from 33 to 46. Output voltage reading recorded by multimeter varies from 5.2 volt to 6.1 volt for the load reading 33 and 46 respectively as shown in table 1. The generated voltage data can be analyzed from the figure 8

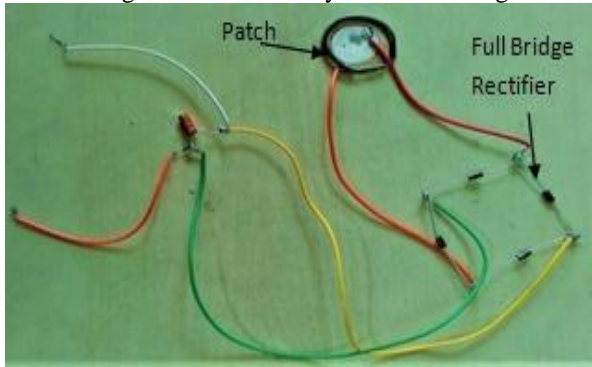

Figure 6. Single piezoelectric full wave rectifier circuit with the circular supported boundary condition



Figure 7. Piezo patch with circular supported boundary condition

Table 1. Circular Supported Boundary Condition

Sr. No.	Output Voltage	Load Applied	No. of Strokes
1.	5.20	33	20
2.	5.90	42	20
3.	6.10	46	20

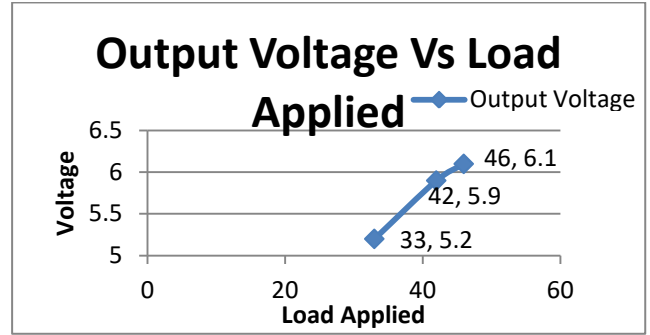

Figure 8. Variation of voltage w.r.t. the load applied to circular supported boundary condition

B. Model Validation

The output voltage generated from the experimental model and from the mathematical model had been compared to validate the present planned work which is shown in table 2. From the table 2 it was observed that the maximum error percentage between experimental and mathematical model is 2.837.

Table 2 Validation table

Sr. No.	No. of Strokes	Load Applied	Experimental Output Voltage	Mathematical Output Voltage	%age Error
1	1	33	0.43	0.4422	2.837
2	1	42	0.55	0.5628	2.327
3	1	46	0.60	0.6164	2.733

V. CONCLUSION

The experimental model to apply the dynamic periodic load on piezoelectric material for energy harvesting created successfully. The setup is used to harvest energy from circular piezo-patch with end supported boundary conditions with full bridge rectifier circuit as a rectifying circuit and 6.10V of voltage is generated. The created model can apply dynamic load at all required places in all the industry. It is noted that after a small fluctuation in initial observations, the voltage output becomes almost steady with respect to applied load. Mathematical modeling of the created system has also been developed which successfully validated with experimental results with a small percentage error 2.837 percentages.

REFERENCES

1. S. R. Hong, S. B. Choi, Y. T. Choi, &N. M. Wereley, "A hydro-mechanical model for hysteretic damping force prediction of ER damper: experimental verification," Journal of Sound and Vibration, 2005, vol.285, no.4-5, pp.1180-1188.
2. A. Benjeddou, "Modelling and simulation of adaptive structures and composites: Current trends and future directions," Progress in computational structures technology, 2004,pp. 251-280.
3. J. Yadav, D. Yadav, R. Vashistha, D. P. Goyal & D. Chhabra, "Green energy generation through PEHF-a blueprint of alternate energy harvesting," International journal of green energy,2019, vol.16, No.3, pp. 242-255.
4. D. Yadav, J. Yadav, R. Vashistha, D. P. Goyal & D. Chhabra, "Modeling and simulation of an open channel PEHF system for efficient PVDF energy harvesting," Mechanics of Advanced Materials and Structures, 2019, pp.1-15.



5. A. Budhwar & D. Chhabra, Comparison of energy harvesting using single and double patch pvdf with hydraulic dynamism, International Journal of R&D in Engineering, Science and Management, 2016, vol.4, no.1, pp. 56-67.
6. E. L. Eremin & E. A. Shelenok, "Automatic control system of testing vibration shaker". In 2013 International Siberian Conference on Control and Communications (SIBCON), IEEE, Sept. 2013, pp. 1-10.
7. X. Fu & W. H. Liao, "Modeling and analysis of piezoelectric energy harvesting with dynamic plucking mechanism," Journal of Vibration and Acoustics, 2019, vol.141, no.3, pp. 031002.
8. J. Y. Lee, M. K. Lee, J. G. Oh & K. S. Kim, "Study on the energy conversion from the dynamic load of vehicles on the road using piezoelectric materials," In Materials Science Forum, Trans Tech Publications, 2010, vol. 658, pp. 57-60.
9. V. K. Mehta & R. Mehta, Principles of Electronics, S. Chand & Co. Ltd., India, 2005.
10. S.K. Vashist and D.Chhabra "Optimal placement of piezoelectric actuators on plate structures for active vibration control using genetic algorithm", Proc. SPIE 9057, Active and Passive Smart Structures and Integrated Systems 2014, 905720 (9 March 2014); <https://doi.org/10.1117/12.2044904>
11. S. R. Hong, S. B. Choi, Y. T. Choi, & N. M. Wereley, "A hydro-mechanical model for hysteretic damping force prediction of ER damper: experimental verification," *Journal of Sound and Vibration*, 2005, vol.285, no.4-5, pp.1180-1188.
12. A. Benjeddou, "Modelling and simulation of adaptive structures and composites: Current trends and future directions," *Progress in computational structures technology*, 2004, pp. 251-280.
13. X. D. Xie, Q. Wang & N. Wu, "Potential of a piezoelectric energy harvester from sea waves," *Journal of Sound and Vibration*, 2014, vol.333, no.5, pp.1421-1429.
14. Y. C. Shu & I. C. Lien, "Analysis of power output for piezoelectric energy harvesting systems," *Smart materials and structures*, 2006, vol.15, no.6, pp.1499.
15. P. Dineva, D. Gross, R. Müller and T. Rangelov, Dynamic fracture of piezoelectric materials, AMC, 2014, vol.10, pp. 12.
16. D. Chhabra, P. Chandna, G. Bhushan. Design and analysis of smart structures for active vibration control using piezo-crystals International Journal of Engineering and Technology, 2014 vol. 1, no. 6, pp.153-162
17. D. Chhabra, G. Bhushan, and P. Chandna. "Multilevel optimization for the placement of piezo-actuators on plate structures for active vibration control using modified heuristic genetic algorithm", Proc. SPIE 9059, Industrial and Commercial Applications of Smart Structures Technologies 2014, 90590J (10 March 2014); <https://doi.org/10.1117/12.2044913>

University Rohtak, Haryana) India. His research interest includes Bio- Fluid Mechanics, Solid Mechanics and Fluid Mechanics.



Dr. Ramesh Kumar Garg is presently working as a Professor & Chairman with Deenbandhu Chhotu Ram University of Science and Technology, Murthal in Department of Mechanical Engineering from India. He has authored more than fifty research papers in international/national journals/ and visited number of countries for academicians programme. His research interests include System Design, Production and Industrial Engineering, Multi-Criteria decision-making Methods and analysis etc.



Dr. Deepak Chhabra is presently working as an Assistant Professor with the Department of Mechanical Engineering, University Institute of Engineering and Technology at Maharshi Dayanand University Rohtak. He has authored more than thirty research papers in international/national journals/book chapter (Elsevier) and visited number of countries for the International conferences. His research interests include Additive manufacturing, Active Vibration Control, 3D Printing, Mechanobiology etc.

AUTHORS PROFILE



Mohit Yadav received the M.Sc. & M.Phil. degree in Mathematics from Maharshi Dayanand University Rohtak, Haryana (INDIA) in 2015 and 2017 respectively. He is currently pursuing his Ph.D degree in Mathematics from the same University in Department of Applied Sciences at University Institute of Engineering & Technology (M.D. University Rohtak, Haryana) India. His research interest include Piezoelectric Energy Harvesting, Fluid Mechanics and Bio-Fluid Mechanics..



Dinesh Yadav received the B.tech & M.Tech degree in Mechanical from Maharshi Dayanand University Rohtak, Haryana (INDIA). He is currently pursuing his Ph.D degree in Deenbandhu Chhotu Ram University of Science and Technology, Murthal in Department of Mechanical Engineering from India. His research interest includes 3-D Printing, Piezoelectric materials and Fluid mechanics



Dr. Surendra Kumar received the M.Sc. degree in Mathematics from Maharshi Dayanand University Rohtak, Haryana (INDIA) in 2001 and Ph.D. in Mathematics in 2011 from the same University. He is currently working in Department of applied Sciences at University Institute of Engineering & Technology (M.D.