

ORIGINAL ARTICLE

A mutation in caspase-9 decreases the expression of BAFFR and ICOS in patients with immunodeficiency and lymphoproliferation

N Clemente¹, E Boggio¹, CL Gigliotti¹, E Orilieri¹, G Cappellano¹, E Toth¹, PA Valletti¹, C Santoro¹, I Quinti², C Pignata³, LD Notarangelo⁴, C Dianzani⁵, I Dianzani¹, U Ramenghi⁶, U Dianzani¹ and A Chiochetti¹

Lymphocyte apoptosis is mainly induced by either death receptor-dependent activation of caspase-8 or mitochondria-dependent activation of caspase-9. Mutations in caspase-8 lead to autoimmunity/lymphoproliferation and immunodeficiency. This work describes a heterozygous H237P mutation in caspase-9 that can lead to similar disorders. H237P mutation was detected in two patients: Pt1 with autoimmunity/lymphoproliferation, severe hypogammaglobulinemia and Pt2 with mild hypogammaglobulinemia and Burkitt lymphoma. Their lymphocytes displayed defective caspase-9 activity and decreased apoptotic and activation responses. Transfection experiments showed that mutant caspase-9 display defective enzyme and proapoptotic activities and a dominant-negative effect on wild-type caspase-9. *Ex vivo* analysis of the patients' lymphocytes and *in vitro* transfection experiments showed that the expression of mutant caspase-9 correlated with a downregulation of BAFFR (B-cell-activating factor belonging to the TNF family (BAFF) receptor) in B cells and ICOS (inducible T-cell costimulator) in T cells. Both patients carried a second inherited heterozygous mutation missing in the relatives carrying H237P: Pt1 in the transmembrane activator and CAML interactor (*TACI*) gene (S144X) and Pt2 in the perforin (*PRF1*) gene (N252S). Both mutations have been previously associated with immunodeficiencies in homozygosis or compound heterozygosis. Taken together, these data suggest that caspase-9 mutations may predispose to immunodeficiency by cooperating with other genetic factors, possibly by downregulating the expression of BAFFR and ICOS.

Genes and Immunity advance online publication, 8 January 2015; doi:10.1038/gene.2014.74

INTRODUCTION

Caspases are a family of cysteine-dependent aspartate-directed proteases present in the cytoplasm as inactive proenzymes; some are involved in apoptotic induction, whereas others are involved in cell activation.^{1–3} In the immune system, apoptosis has a crucial role in the deletion of autoreactive lymphocytes and in cell-mediated cytotoxicity. Apoptosis acts via two pathways: the *extrinsic pathway* triggered by surface death receptors that belong to the tumor necrosis factor receptor family, which induce activation of caspase-8 and -10, and the *intrinsic pathway* that proceeds through the mitochondrial release of cytochrome *c* and activation of caspase-9.⁴ Both pathways converge in the activation of effector caspases (caspase-3, -6 and -7) and are partly interconnected because caspase-8 cleaves BH3 interacting-domain death agonist (Bid) and this induces cytochrome *c* release from the mitochondria.^{5–7}

Caspases may also exert non-apoptotic functions, such as influencing cell proliferation, migration and the immune response.^{8,9} They are involved in the differentiation of several cell types, including macrophages, and may have a role in the secretion of cytokines and growth factors.^{10–13} Moreover, activation of caspases in a temporally and spatially restricted manner may mediate localized cellular remodeling.¹³

Deleterious caspase-8 gene mutations cause a peculiar immunological phenotype, in which B- and T-cell accumulation in the lymph nodes and spleen is associated with severe hypogammaglobulinemia, increased susceptibility to infections and defective apoptosis and lymphocyte activation *in vitro*.¹⁴ The involvement of caspase-8 in lymphocyte activation was confirmed by several reports showing that its inhibitors decrease lymphocyte activation *in vitro* and its inactivation causes immunodeficiency in mice.^{13,15} It has been suggested that this effect may depend on the inhibition of a caspase-dependent cleavage of proteins involved in either cell cycle control (such as p27^{KIP1}) or signaling (such as FADD-like interleukin-1 β -converting enzyme-like inhibitory protein, FLIP). Moreover, caspase-8 is involved in the activation of the nuclear factor- κ -light-chain-enhancer of activated B cells (NF- κ B), a transcription factor that is crucial for lymphocyte activation.^{16–18}

Caspase-3 has also been suggested to influence the immune system; its loss in mice results in B- and T-cell accumulation in the lymph nodes and spleen, ascribed to defective apoptosis for T cells and to altered regulation of cell cycle for B cells.¹⁹

Loss-of-function mutations of the caspase-10 gene (*CASP10*) can cause the autoimmune lymphoproliferative syndrome (ALPS; OMIM no. 601859) due to defective function of the Fas death receptor.²⁰ In most ALPS patients, the Fas defect is due to

¹Interdisciplinary Research Center of Autoimmune Diseases (IRCAD) and Department of Health Sciences, University of Eastern Piedmont 'A Avogadro', Novara, Italy; ²Department of Clinical Immunology, University of Rome 'La Sapienza', Rome, Italy; ³Department of Pediatrics, 'Federico II' University, Naples, Italy; ⁴Division of Immunology, Children's Hospital, Harvard Medical School, Boston, MA, USA; ⁵Department of Drug Science and Technology, University of Turin, Turin, Italy and ⁶Department of Pediatrics, University of Turin, Turin, Italy. Correspondence: Dr A Chiochetti, Interdisciplinary Research Center of Autoimmune Diseases (IRCAD) and Department of Health Sciences, University of Eastern Piedmont 'A Avogadro', via Solaroli 17, Novara 28100 Italy.

E-mail: annalisa.chiochetti@med.unipmn.it

Received 23 May 2014; revised 9 October 2014; accepted 17 November 2014

mutations of the Fas gene, although mutations of the Fas ligand (*FasL*) or caspase-10 genes have been occasionally detected, whereas the mutated gene is unknown in some patients.^{20–24} ALPS is characterized by polyclonal accumulation of lymphocytes in the spleen and lymph nodes, with lymphadenomegaly and/or splenomegaly and expansion of T-cell receptor $\alpha\beta^+$ T cells lacking CD4 and CD8, namely double-negative T cells. These patients frequently display autoimmune manifestations during childhood and may develop lymphomas in adulthood.²⁴ We have also previously described an incomplete form of ALPS that lacks the expansion of double-negative T cells, a required criterion for ALPS diagnosis; this variant form has been named Dianzani autoimmune lymphoproliferative disease (DALD) by Victor McKusick (OMIM no. 605233).^{25,26}

Typically, ALPS patients display hypergammaglobulinemia, but we previously described a subgroup that developed hypogammaglobulinemia during the course of disease.^{24,27} This phenotype resembles that of common variable immunodeficiency (CVID; OMIM no. 240500), a primary immunodeficiency characterized by defective antibody production and hypogammaglobulinemia.^{28,29} CVID usually manifests during the second and third decade by recurrent bacterial infections of the upper and lower respiratory tract; up to 20% of CVID patients also display signs of autoimmunity and lymphoproliferation (splenomegaly). Moreover, both ALPS and CVID patients may display a skewed distribution of B-cell subsets.^{30,31}

CVID may be caused by variations in several genes involved in B-cell activation and differentiation, including the *CD19/CD21/CD81*, transmembrane activator and calcium modulator and cyclophilin ligand interactor (*TACI* or *TNFRSF13B*), B-cell-activating factor belonging to the TNF family (*BAFF*) receptor (*BAFFR*) and inducible T-cell costimulator (*ICOS*) genes.^{29,32} *CD19*, *CD21* and *CD81* are components of the coreceptor of the B-cell receptor and are involved in B-cell activation. *TACI* and *BAFFR* (or *TNFRSF13C*) are expressed by B cells and bind the *BAFF* cytokine, thereby having a role in B-cell activation and survival. *ICOS* is expressed by activated T cells and has a role in the formation of lymphoid follicles by binding the *ICOS* ligand (*ICOSL* or *B7h*, or *B7H2*) expressed by B cells.³²

Other diseases that may display mixed features of lymphoproliferation and immunodeficiency are familial hemophagocytic lymphohistiocytosis (FHL; OMIM no. 603553), due to defective function of perforin, which leads to ineffective immune hyperactivation upon viral infection, with tissue damage and a fatal outcome;^{33,34} and X-linked lymphoproliferative syndrome (XLP; OMIM no. 308240), due to the deficiency of either *SAP*

(*SLAM-associated protein*) or *XIAP* (*X-linked inhibitor of apoptosis protein*), thereby causing increased susceptibility to Epstein–Barr virus infection.³⁵ All these cases are intriguing because they show that autoimmunity/lymphoproliferation and immunodeficiency overlap in several diseases. The aim of this study was to assess the involvement of mutations in the caspase-9 gene (*CASP9*) in the development of hypogammaglobulinemia and/or lymphoproliferation. We began our analysis with patients displaying both clinical phenotypes and then considered those with either ALPS or hypogammaglobulinemia. We detected a heterozygous H237P mutation in two patients who also carried a second heterozygous mutation: one in the *TNFRSF13B* gene, which encodes *TACI*, and the other in *PRF1* gene, which encodes perforin. Analysis of the patients' lymphocytes and the transfection experiments of the mutated *CASP9* cDNA in lymphocytes showed that expression of the mutated caspase-9 protein correlated with the downregulation of *BAFFR* in B cells and *ICOS* in T cells, which may be involved in the patients' low immunoglobulin (Ig) levels.

RESULTS

Patient analyses

CASP9 variations were searched in the genomic DNA from seven patients displaying autoimmunity, chronic lymphadenomegaly and/or splenomegaly and hypogammaglobulinemia. We sequenced exons from 2 to 9 and their intron/exon boundaries but not exon 1, as no amplification was obtained with four different sets of primers because of its high GC content. We detected a heterozygous 710A>C nucleotide substitution (nucleotide position given from the ATG translation initiation site) in exon 5 in one patient (Pt1) (Figures 1 and 2a, b). This mutation results in the amino-acid substitution H237P (*CASP9*^{H237P}) and it was not detected in any of the 140 healthy donors. This variation has been described in the dbSNP database as a rare variant with an allelic frequency < 0.01% (rs 146054764).

Pt1 was an 18-year-old male, displaying features of both ALPS and CVID since the age of 3 years. The signs of ALPS were chronic thrombocytopenia, lymphadenomegaly, splenomegaly and expansion of double-negative T cells (8–10%) in the peripheral blood, whereas those of CVID were severe hypogammaglobulinemia (low IgM, IgG and IgA levels), recurrent pulmonary infections with bronchiectasia and retarded physical growth. In his family, the mutation was carried by the father (F1) and the elder sister (S1a), but not by the mother (M1) or the younger sister (S1b) (Figure 2b).

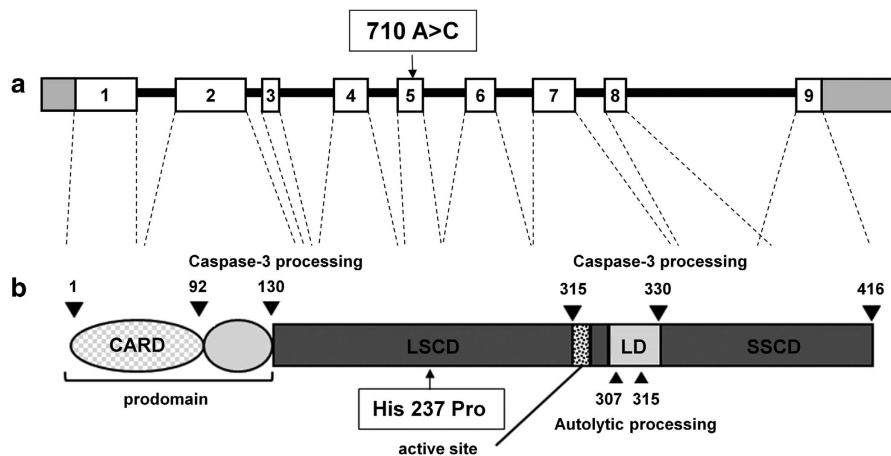

Figure 1. *CASP9* variation carried by the patients. Graphical representation (not in scale) of caspase-9 gene: (a) boxes represent the exons; arrows indicate the mutation and protein (b); and numbers indicate the amino-acid positions. CARD, caspase recruitment domain; LD: linker between the two subunits; LSCD: large subunit catalytic domain; SSCD: small subunit catalytic domain.

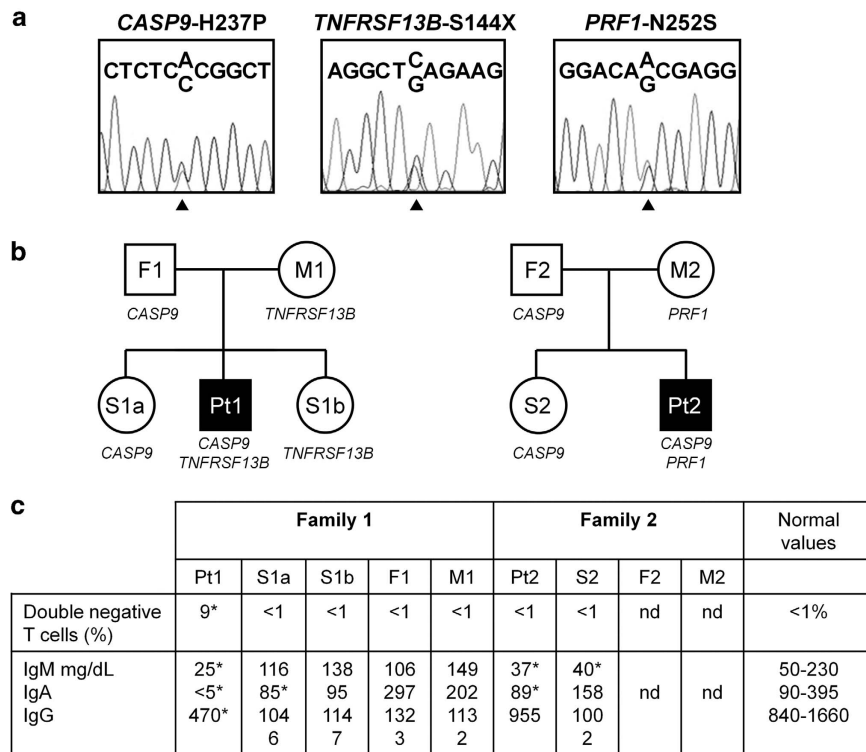

Figure 2. Pedigrees of family 1 and family 2. **(a)** Electropherograms of *CASP9*, *TNFRSF13B* (*TACI*) and *PRF1* sequences performed on the genomic DNA of Pt1 for *CASP9* and *TNFRSF13B* and of Pt2 for *PRF1*. Black arrows show the heterozygous position. **(b)** Pedigrees of family 1 and family 2 showing the inheritance of the *CASP9*^{H237P} mutation; inheritance of the S144X *TNFRSF13B* and N252S *PRF1* mutations are also shown. Circles represent females; squares males; patients are shown in black. **(c)** Levels of blood double-negative (DN) T cells and serum Ig in the patients' families.

The discovery of a mutation in *CASP9* in a subject with signs of both ALPS and CVID prompted us to extend the analysis to 78 patients with ALPS or DALD, lacking Fas, FasL, caspase-10 and caspase-8 mutations, and 51 patients with primary hypogammaglobulinemia, including 45 who fulfilled the diagnostic criteria for CVID, but displayed no signs of ALPS or DALD. We found the same mutation (710A>C) in one adult patient (Pt2), who displayed recurrent otitis media and respiratory infections during childhood and low serum IgM levels, whereas his IgA and IgG levels were, respectively, borderline and normal. He never showed signs of ALPS or DALD and he remained healthy in adulthood until he developed Burkitt lymphoma at the age of 30. In Pt2's family, the mutation was carried by the father (F2) and sister (S2) but not by the mother (M2) (Figure 2b). Both Pt1 and Pt2 were Italian but from different geographic origins. No other mutations in *CASP9* were detected in any patient.

Because both Pt1 and Pt2 displayed hypogammaglobulinemia, we assessed the Ig levels in the available sera of the patients' healthy family members. The results showed that all the relatives displayed normal Ig levels, except for individuals S1a and S2, who carried *CASP9*^{H237P} and displayed slightly decreased IgA and IgM levels, respectively (Figure 2c). This analysis was not performed in individuals F2 and M2 as their sera were not available.

Then, the genetic analysis was extended to the *ICOS*, *TACI* and *BAFFR* genes, involved in CVID;^{29,32} *FAS*, *FASL* and *CASP10* involved in ALPS;²⁴ *PRF1*, *UNC13D* and *STX11* (syntaxin 11) involved in FLH;^{33,34} and *SAP* and *XIAP* involved in XLP.³⁵

Results showed that Pt1 carried two mutations in *TACI*, a 431C>G and a 577T>C substitution that result in the S144X and C193R changes, respectively (Figures 2a and b). Homozygosity for a different base change causing S144X (431C>A) has previously been associated with CVID and this mutant allele is not expressed.³⁶ Both mutations were detected in M1 and S1b, but

neither were detected in F1 and S1a, which shows that they were located at the same allele (Figure 2b). Furthermore, the S144X mutation was not detected in any of the 100 healthy individuals. By contrast, Pt2 carried a variation in *PRF1*, an A>G substitution at position 755 causing an N252S change (rs150053969) that has been associated with FLH, ALPS, type 1 diabetes and B-cell lymphomas.^{33,37-39} This mutation was detected in M2, but not S2 (Figure 2b). In healthy donors, its allelic frequency was >0.02% (2/816).

As both patients displayed decreased Ig levels *in vivo*, we assessed surface expression of CD19, *TACI*, *BAFFR* and *ICOS* (involved in CVID) in the patients' peripheral blood mononuclear cells (PBMCs) by immunofluorescence and flow cytometry (Figure 3). In resting PBMCs, we assessed the expression of *TACI*, *BAFFR* and HLA-DR in CD19⁺ B cells, whereas the expression of *ICOS*, HLA-DR and CD25 was assessed in CD3⁺ T cells from phytohemagglutinin (PHA)-activated PBMCs. The results showed that both patients displayed decreased expression of *BAFFR* in B cells and decreased expression of *ICOS* in activated T cells. By contrast, expression of *TACI* was in the normal range in the B cells of both patients, but it was borderline in Pt1, congruent with his mutation of the *TACI* gene. Moreover, B-cell expression of CD19 and HLA-DR, and T-cell expression of CD3, CD8, CD4, HLA-DR and CD25 were in the normal range in both patients (data not shown).

Lymphocyte activation was assessed in the patients' PBMCs by evaluating the response to anti-CD3 monoclonal antibody (mAb) in terms of proliferation and interleukin (IL)-2 secretion (Figure 4a) and the response to pokeweed mitogen (PWM) in terms of proliferation and secretion of IgM and IgG (Figure 4b). The results showed that all these lymphocyte activation responses were defective in both patients. Moreover, we evaluated whether the defective proliferative response to CD3 could be overcome by CD28 costimulation, or by the addition of exogenous IL-2

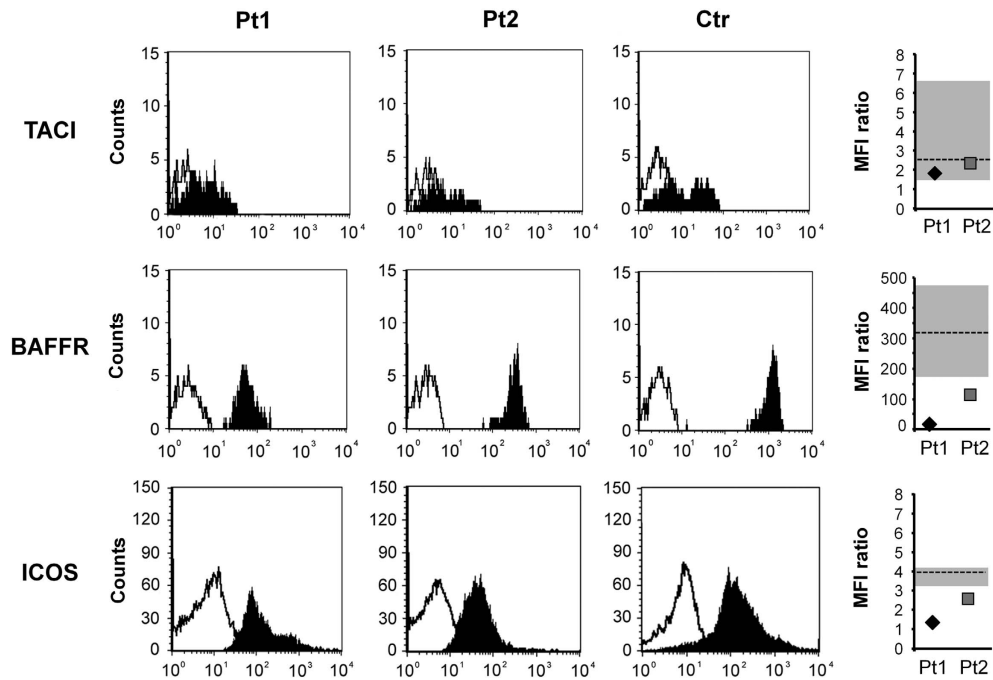

Figure 3. Surface expression of TACI, BAFFR and ICOS in PBMCs from patients and healthy donors. Cytofluorimetric histograms showing the surface expression of TACI and BAFFR assessed in CD19⁺ cells and of ICOS in PHA-activated CD3⁺ T cells by two-color immunofluorescence: unstained cells (white) and stained cells (black). The graphs on the right show the MFI ratios of the patients and the controls; the gray boxes indicate the 5th–95th percentile and the dashed lines show the median of 17 controls.

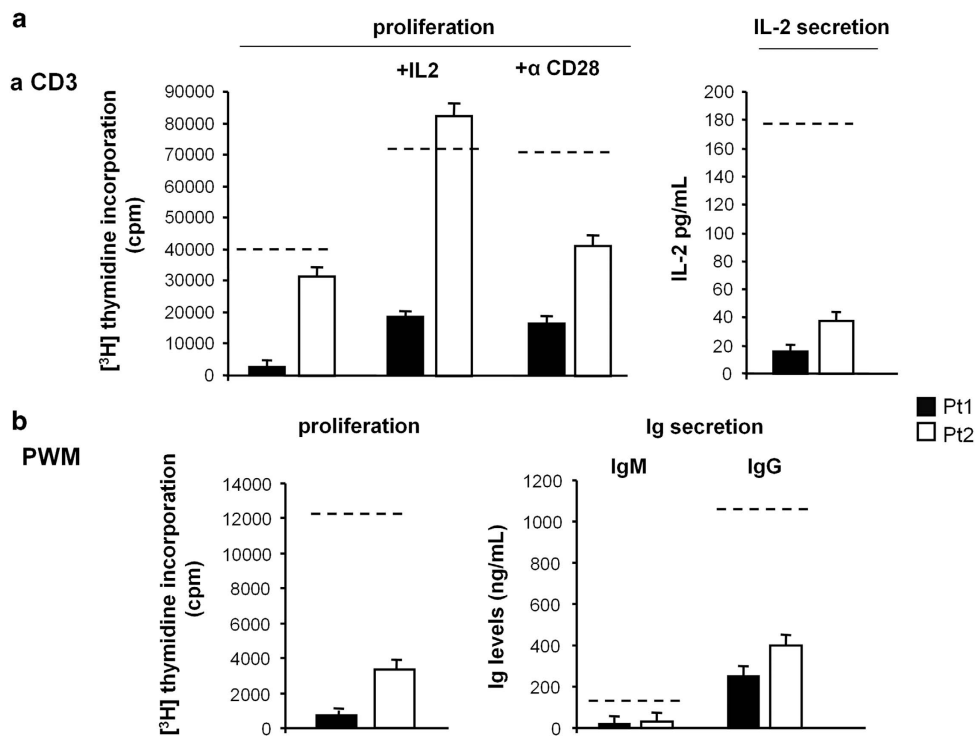

Figure 4. Proliferation and effector properties after stimulation with anti-CD3 mAb or PWM in Pt1 and Pt2. (a) Cell proliferation and IL-2 secretion induced by stimulation of PBMCs with anti-CD3 mAb (1 $\mu\text{g ml}^{-1}$) and cell proliferation induced by anti-CD3+exogenous IL-2 (10 U ml⁻¹) and anti-CD3+anti-CD28 (10 $\mu\text{g ml}^{-1}$) mAb. (b) Cell proliferation and secretion of IgM and IgG induced by stimulation of PBMCs with PWM (10 $\mu\text{g ml}^{-1}$). The dotted lines indicate the 5th percentile of the activity displayed by all normal controls ($n = 19$). Each patient was analyzed four times using different blood samples and the results are shown as the mean \pm s.e.

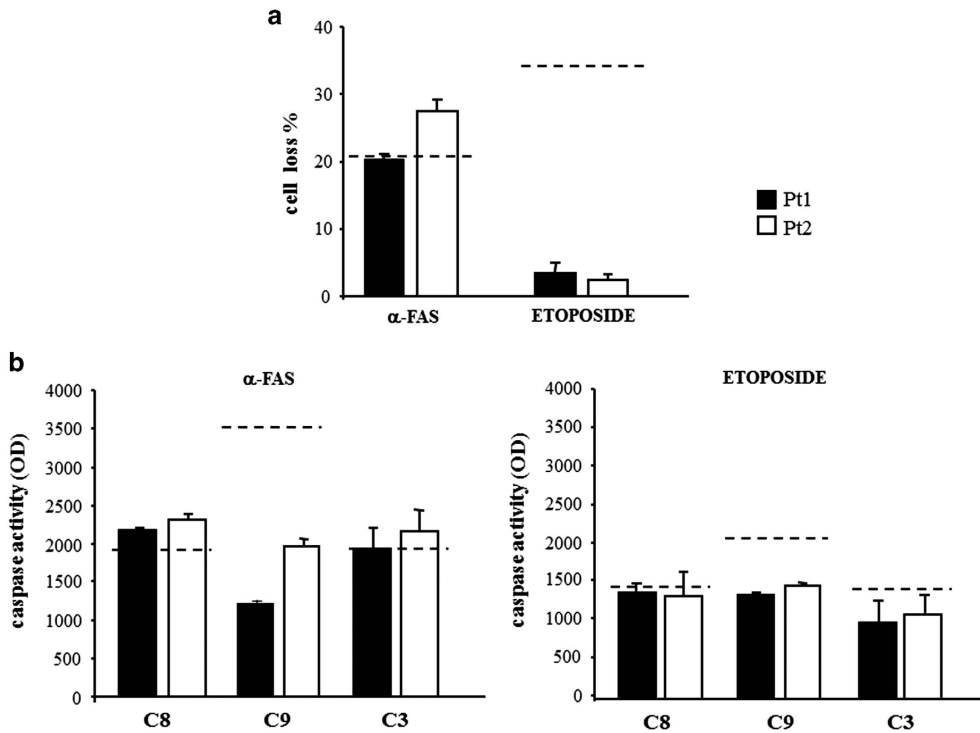

Figure 5. Cell loss and caspase-8, -9 and -3 activation induced by anti-Fas mAb or etoposide in Pt1 and Pt2 T cells. PBMCs were activated with PHA at days 0 ($1 \mu\text{g ml}^{-1}$) and 8 ($0.1 \mu\text{g ml}^{-1}$) and cultured in RPMI 1640+10% fetal calf serum (FCS)+exogenous IL-2 (10 U ml^{-1}). Days after the second stimulation, cells were treated with either anti-Fas mAb or etoposide. (a) Cell loss was assessed by counting live cells (evaluated by the trypan blue exclusion test) in each well and (b) caspases activation by fluorimetric assays in cells treated or untreated with etoposide. The dotted lines indicate the 5th percentile of the activity displayed by normal controls ($n = 19$). Each patient was analyzed four times using different blood samples and the results are shown as the mean \pm s.e.

(10 U ml^{-1}) because both patients displayed defective IL-2 secretion. The results showed that both exogenous IL-2 and CD28 costimulation had some effect in both patients and exogenous IL-2 rescued the defect in Pt2 (Figure 4a).

Functional characterization of *CASP9*^{H237P}

To assess the function of the mutated protein (*CASP9*^{H237P}), either anti-Fas mAb or etoposide was used to activate the extrinsic or the mitochondrial pathway, respectively, and to trigger apoptosis in PBMCs from both patients. Then, we analyzed the apoptotic response in terms of cell loss and activation of caspase-8 (extrinsic pathway), caspase-9 (mitochondrial pathway) and caspase-3 (effector pathway). Figure 5 shows that both patients displayed defective activation of caspase-9 and normal activation of caspase-8 in response to either anti-Fas or etoposide. Moreover, they displayed defective cell loss and defective activation of caspase-3 in response to etoposide but not to anti-Fas.

To further assess *CASP9*^{H237P} function, cDNAs coding for *CASP9*^{H237P} or the wild-type protein (*caspase-9*^{WT}) were cloned into the pcDNA3.1 vector (mock), fused to hemagglutinin (HA)- or FLAG-tag sequences, respectively (*H237P*^{HA} and *WT*^{FLAG} plasmids). Then, 293T cells, expressing minimal levels of endogenous caspase-9, were transiently transfected with either mock alone (293T^{MOCK}), *WT*^{FLAG} plus mock (293T^{WT}), *H237P*^{HA} plus mock (293T^{H237P}) or *WT*^{FLAG} plus *H237P*^{HA} (293T^{WT/H237P}). Western blot analysis showed that spontaneous cleavage of caspase-9, which is a sign of its autoactivation, was detectable in 293T^{WT}, but not in 293T^{H237P} or 293T^{WT/H237P} expressing cells (Figure 6a). Then, we assessed cell recovery and activation of caspase-9 in these cells cultured in the presence and absence of etoposide. Results showed that cell recovery was significantly lower and caspase-9 activity was higher in 293T^{WT} than in 293T^{H237P} and 293T^{WT/H237P} either in the presence or in the absence of etoposide

(Figures 6b and c). These data indicate that *CASP9*^{H237P} is less active than *caspase-9*^{WT} and that it exerts a dominant-negative effect on *caspase-9*^{WT}. As caspase-9 activity involves caspase-9 interaction with apoptotic protease-activating factor (APAF)-1 to form the apoptosome, we assessed this interaction by immunoprecipitating caspase-9 and assessing APAF-1 co-immunoprecipitation by western blot in 293T^{WT} and 293T^{H237P}. Results detected the co-immunoprecipitation in 293T^{WT} but not in 293T^{H237P} (Figure 6d), which shows that *CASP9*^{H237P} displays defective interaction with APAF-1.

To confirm these data, PBMCs from healthy donors were transfected with a mock plasmid carrying green fluorescence protein (GFP) in the absence (PBMCs^{GFP}) or presence (PBMCs^{H237P}) of *H237P*^{HA} and cultured for 5 days in the presence of PWM or PHA. Then, cell proliferation was assessed by the incorporation of [³H]thymidine (TdR). The results showed that cell proliferation was lower in PBMCs^{H237P} than in PBMCs^{GFP} (Figure 7a). The effect on the apoptotic response was assessed on PHA-activated PBMCs (PHA-PBMCs) transfected at day 5 of culture to obtain PBMCs^{GFP} and PBMCs^{H237P}. Twenty-four hours later, cells were treated with anti-Fas mAb or etoposide to evaluate cell loss and activation of caspase-9. Results showed that PHA-PBMCs^{H237P} displayed lower cell loss and caspase-9 activation than PHA-PBMCs^{GFP} in response to both treatments (Figures 7b and c). Finally, the effect on cell cycle was analyzed by assessing the expression of p27^{KIP1} in PHA-PBMCs transfected at day 5 to obtain PHA-PBMCs^{GFP} and PHA-PBMCs^{H237P}, or co-transfected with *WT*^{FLAG} plus *H237P*^{HA} (PHA-PBMCs^{WT/H237P}). Twenty-four hours later, western blot analysis detected higher levels of p27^{KIP1} in PHA-PBMCs^{H237P} and PHA-PBMCs^{WT/H237P} than in PHA-PBMCs^{GFP} (Figure 7d).

To assess whether *CASP9*^{H237P} influences the expression of BAFFR, we compared the expression of BAFFR, TACI, HLA-DR and B7h in CD19⁺ B cells from resting PBMCs^{H237P} and PBMCs^{GFP} by

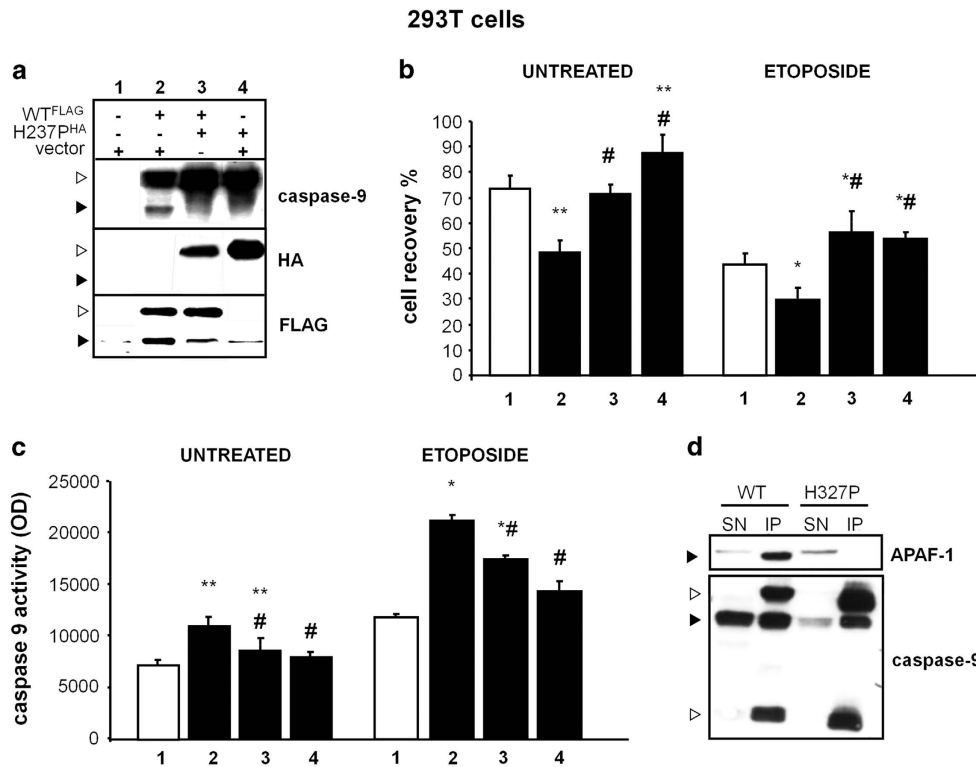

Figure 6. CASP9^{H237P} impairs the apoptotic response and caspase-9 activation in 293T-transfected cells. **(a)** Western blot analysis of cell lysates obtained from 293T cells transfected with the empty pcDNA3.1 vector or WT^{FLAG} or H237P^{HA} or both are shown. The white arrow shows the procaspase-9 and the black arrow indicates the cleaved form. **(b)** Cell recovery and **(c)** caspase-9 activity evaluated 18 h after transfection, as indicated in the panel a, and cultured in the presence and absence of etoposide (5 $\mu\text{g ml}^{-1}$); data are expressed as the mean \pm s.e. of the results from six experiments. *Differences vs empty vector; #differences vs WT^{FLAG} (* $P < 0.05$; ** $P < 0.01$). **(d)** Co-immunoprecipitation of caspase-9 and APAF-1 in cell lysates from 293T cells transfected with WT^{FLAG} or H237P^{HA}. Upper panel shows lysates immunoprecipitated with anti-caspase-9 and blotted with anti-APAF-1; lower panel is the same blot decorated with an anti-caspase-9 antibody; the black arrows mark the specific signals and the white arrows mark the heavy and light Ig chains.

two-color immunofluorescence 24 h after the transfection. Moreover, the effect on the expression of ICOS was assessed on PHA-PBMCs transfected at day 3 of culture to obtain PHA-PBMCs^{GFP} and PHA-PBMCs^{H237P}. Twenty-four hours later, expression of ICOS, CD25 and HLA-DR was assessed in CD3⁺, CD4⁺ and CD8⁺ T cells by two-color immunofluorescence. The results showed that CD19⁺ PBMC^{H237P} expressed lower levels of BAFFR than CD19⁺ PBMCs^{GFP} (Figure 8a), whereas the expression of TACI, HLA-DR, B7h and CD19 was similar in the two cell preparations (data not shown). Moreover, CD3⁺ PHA-PBMC^{H237P} expressed lower levels of ICOS than CD3⁺ PHA-PBMCs^{GFP} (Figure 8b), which was detected in both the CD4⁺ and CD8⁺ T-cell subsets (data not shown), whereas expression of CD3, CD4, CD8, CD25 and HLA-DR was similar in the two cell preparations (data not shown). To confirm these results, the transfection experiments were repeated in TonsBCs (B cells from tonsils) and Raji cells, expressing high levels of BAFFR, and in PHA-TH (PHA-activated purified CD4⁺ T helper) cells, expressing high levels of ICOS. The results demonstrated that the expression of BAFFR was lower in TonsBC^{H237P} and Raji^{H237P} than in TonsBC^{GFP} and Raji^{GFP} (Figure 8a) and that the expression of ICOS was lower in PHA-TH^{H237P} than in PHA-TH^{GFP} (Figure 8b).

To confirm that defective caspase-9 activity may modulate the expression of BAFFR and ICOS and cell proliferation, we treated PHA-activated PBMCs from healthy donors with Z-VAD-FMK (30 μM), inhibiting caspase-9 and other caspases, at day 3 from activation and assessed BAFFR and ICOS expression, cell proliferation and the apoptotic response to etoposide at day 5. Results showed that Z-VAD-FMK significantly decreased BAFFR and ICOS expression, cell proliferation and cell apoptosis (Supplementary Figure 1).

DISCUSSION

This work shows that the H237P substitution decreases caspase-9 activity and impairs lymphocyte apoptosis and activation. The defective enzyme activity caused by this mutation is in line with the notion that the hydrazolic group of histidine 237 may coordinate the key cysteine of the catalytic site.⁴⁰

The defects in caspase-9 activity and apoptotic response were demonstrated in primary patient lymphocytes, as well as in cell lines transfected with H237P^{HA}. Transient transfection of 293T cells showed that CASP9^{H237P} had lower enzymatic and proapoptotic activity than caspase-9^{WT} and also inhibited the function of caspase-9^{WT} through a dominant-negative effect. This was surprising because caspase-9 activation requires aggregation of the apoptosome, a molecular platform composed of seven molecules of APAF-1, cytochrome *c* and ATP. Each APAF-1 molecule binds to one procaspase-9 molecule, which then recruits another APAF-1 molecule.⁴¹ Therefore, recruitment of inactive forms of caspase-9 or a reduced association with APAF-1 may affect the overall function of the apoptosome, as has been previously shown by other authors using deletion mutants of caspase-9.⁴² Transient transfection of 293T cells showed that CASP9^{H237P}, differently from caspase-9^{WT}, is not associated to APAF-1 at detectable levels.

The defect in lymphocyte activation was shown in the patients' lymphocytes that displayed defective CD3-induced proliferation and IL-2 secretion and defective PWM-induced proliferation and Ig secretion. The effect of defective caspase-9 activity on lymphocyte activation was confirmed by the decreased proliferative response displayed by normal PBMCs transfected with CASP9^{H237P} or treated with the caspase inhibitor Z-VAD-FMK.

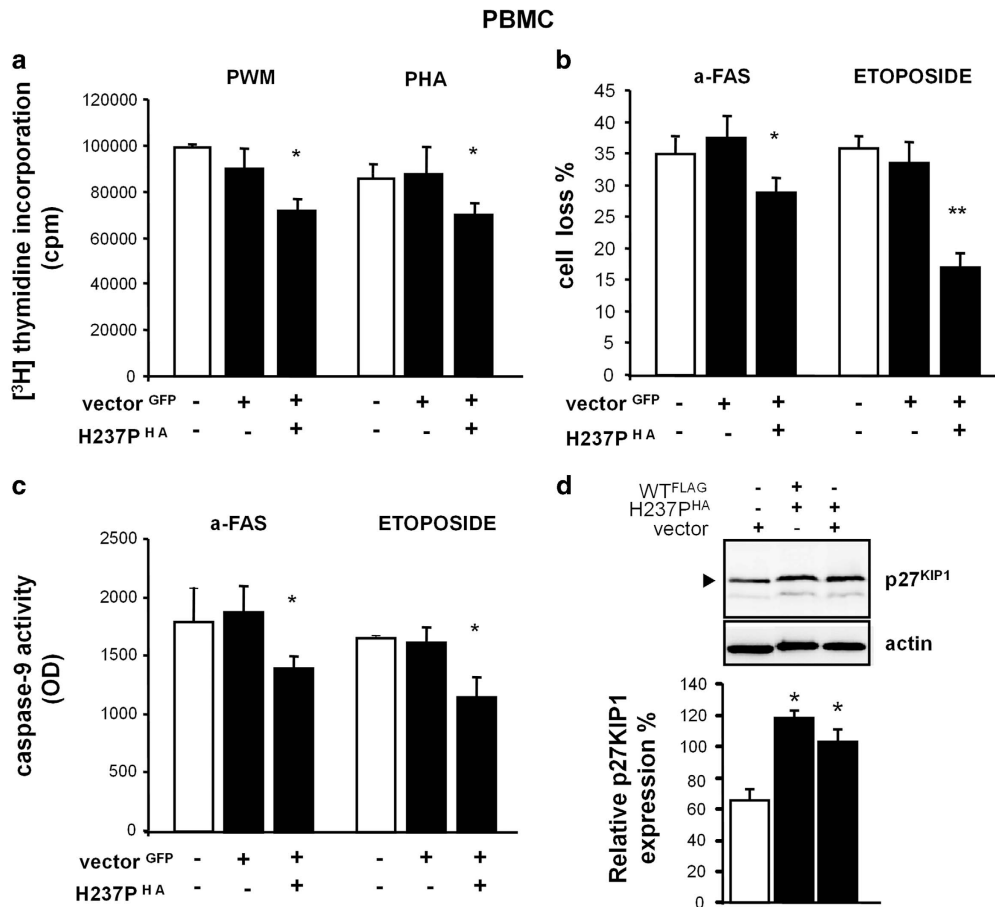

Figure 7. *CASP9^{H237P}* impairs the proliferative and apoptotic responses and caspase-9 activation in transfected PBMCs. (a) Resting PBMCs from normal donors were transiently transfected with vector^{GFP} alone or plus H237P^{HA} (C9). Cell proliferation in response to PWM or PHA was assessed by incorporation of [³H]thymidine. (b) Cell loss and (c) caspase-9 activity in response to treatment with anti-Fas mAb or etoposide. Data are expressed as the mean \pm s.e. ($n = 9$). (d) Western blot and respective relative expression levels (\pm s.e.) of p27^{KIP1} normalized to actin expression from four independent experiments in transfected PHA-PBMCs. The black arrow indicates the p27^{KIP1} relative band. Asterisks mark differences from GFP-transfected cells. The percentage of GFP-positive cells was $52 \pm 5\%$ (mean \pm s.e.) for PBMCs^{GFP} and $54 \pm 4\%$ for PBMCs^{H237P}.

The dual effect of the caspase-9 defect on lymphocyte apoptosis and activation mimics the defects observed in two siblings carrying homozygous mutations of the caspase-8 gene.¹⁴ They displayed defective lymphocyte apoptosis, as well as impaired activation of T, B and natural killer cells, defective IL-2 secretion and developed a disease with ALPS, hypogammaglobulinemia and increased susceptibility to infections. The heterozygous carriers were healthy.

In Pt1 and Pt2, as in the caspase-8 deficient patients, the lymphocyte apoptosis and activation defects paralleled a clinical phenotype with impaired immune function and lymphoproliferation. The most severe phenotype was displayed by Pt1 with overt CVID and ALPS. Pt2 displayed milder symptoms displayed by decreased serum IgM, increased susceptibility to infections during childhood and development of Burkitt lymphoma in adulthood. The lymphoma could be a consequence of immunodeficiency, but might also be favored by an unapparent preneoplastic lymphoproliferation, which is regarded as a cause of lymphomas.^{43,44} It is noteworthy that even the ALPS displayed by Pt1 can be regarded as a preneoplastic lymphoproliferation because it predisposes patients to lymphoma development. The involvement of caspase-9 in lymphoma development is also suggested by the finding that high expression of Bcl-2 and XIAP, which inhibit caspase-9 activation, and defective apoptotic response to etoposide

correlate with an unfavorable prognostic value in diffuse large B-cell lymphomas.⁴⁵

An unexpected effect of the *CASP9* mutation was its involvement in decreasing the expression of BAFFR and ICOS. This is shown by the finding that both patients displayed decreased expression of these receptors in B cells and activated T cells, respectively. Moreover, transfection of *CASP9^{H237P}* or treatment with Z-VAD-FMK decreased the expression of BAFFR in B cells and ICOS in activated T cells from normal donors. This effect was specific because expression of several other cell markers were unchanged.

The inhibitory effect of *CASP9^{H237P}* on cell proliferation and apoptosis was independent of its effect on the expression of BAFFR and ICOS, as it was also detected in 293T cells, which do not express those receptors. Moreover, transfection of ICOS in PBMCs transfected with *CASP9^{H237P}* rescued the decreased expression of ICOS but not the decreased proliferative and apoptotic responses of these cells (data not shown). As suggested for caspase-8, this effect might be due to inhibition of a caspase-dependent cleavage of proteins involved in the control of cell cycle, as indicated by the increased expression of p27^{KIP1}, which is expected to block cell entry into the S phase, displayed by PBMCs transfected with *CASP9^{H237P}*.

BAFFR and ICOS have a role in follicle formation because BAFFR is expressed by follicular B cells and supports their survival,⁴⁶

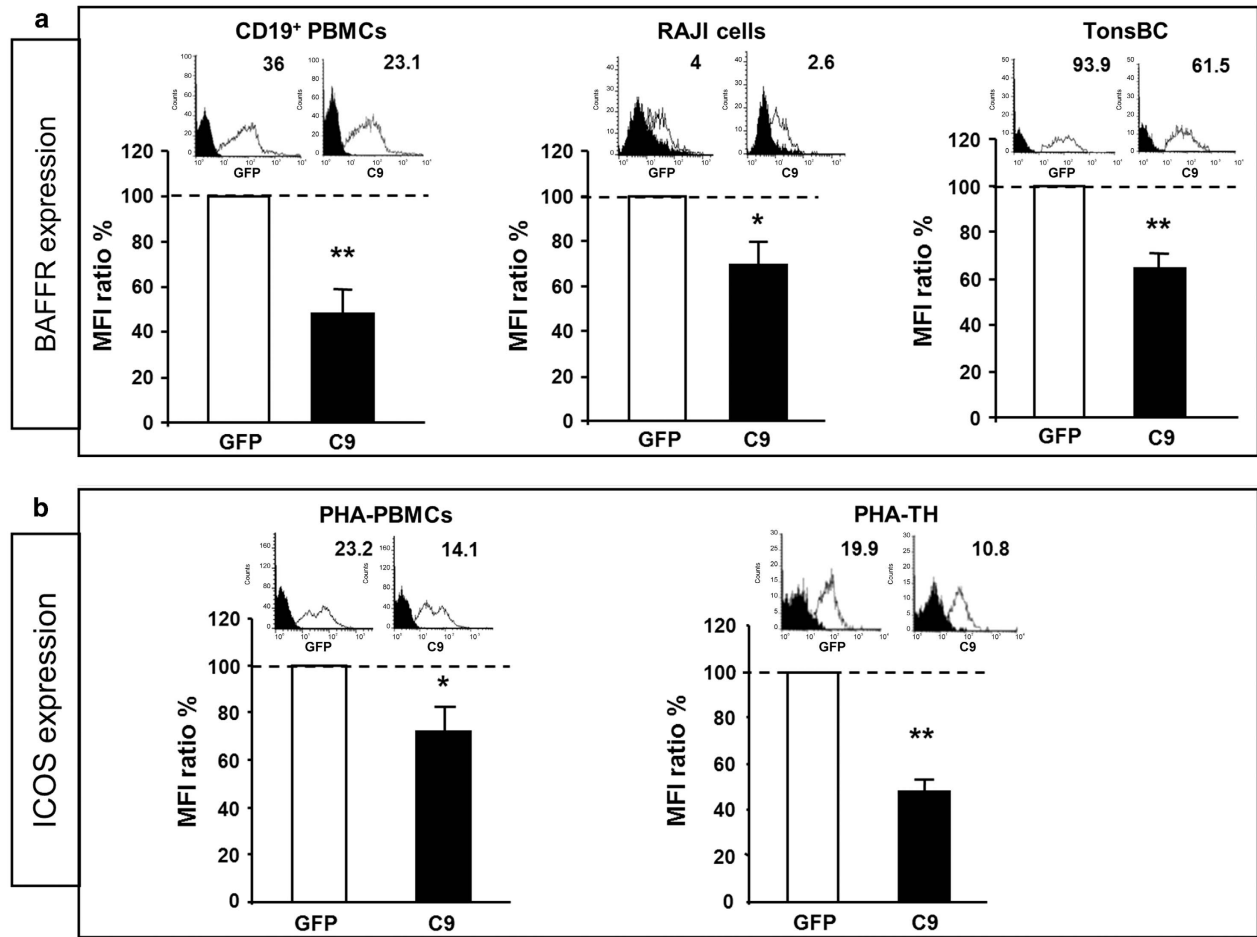

Figure 8. Surface expression of BAFFR and ICOS in lymphocytes of healthy donors after transient transfection of *CASP9*^{H237P}. **(a)** Expression of BAFFR in CD19⁺ PBMCs, Raji cells and total TonsBCs transiently transfected with vector^{GFP} alone or plus H237P^{HIA} (C9). **(b)** Expression of ICOS in CD3⁺ PBMCs (PHA-PBMCs) or purified CD4⁺ T cells (PHA-TH) transiently transfected with vector^{GFP} alone or with H237P^{HIA} (C9). Upper panels show representative cytofluorimetric histograms of the unstained cells (black) and the stained cells (white); numbers indicate the mean fluorescence intensity ratio (MFI-R). Lower panels show the mean \pm s.e. of MFI-R of BAFFR or ICOS expression from nine experiments; results are relative to the BAFFR or ICOS expression displayed by GFP-transfected set at 100% (dotted line) in each experiment. Asterisks mark differences from GFP-transfected cells. The 100% value corresponded to MFI ratio = 65 ± 8 for BAFFR and 11 ± 2 for ICOS.

whereas ICOS is expressed by T helper follicular cells and interacts with both cognate and bystander B cells.⁴⁷ Therefore, the low expression of BAFFR and ICOS may explain the low Ig levels of our patients, which seems to be a hallmark of the *CASP9* mutation because it was detected in all of the patients' family members carrying the *CASP9*^{H237P} but not in the others. Unfortunately, we could not assess BAFFR and ICOS expression in these family members because their cells were not available.

Penetrance of *CASP9*^{H237P} seems to be incomplete as the four carriers in the patients' families were healthy, although two of them (S1a and S2) displayed a subclinical defect with a mild decrease of serum IgM and IgA, respectively. The severity of the clinical outcome may thus depend on the influence of concurrent genetic and environmental factors. Congruent with the role of concurrent genetic factors, Pt1 and Pt2 each carried heterozygous mutations of a second gene. This was inherited from their *CASP9*^{H237P}-free mothers and may have contributed to their clinical outcome.

Pt1 carried a S144X mutation in *TNFRSF13B* coding for TACI, a receptor that binds BAFF and APRIL (a proliferation-inducing ligand). TACI is expressed on peripheral blood B cells, particularly on the CD27⁺ subset. TACI-deficient mice display humoral immunodeficiency together with autoimmunity and lymphoproliferation.^{36,48,49} In humans, several *TNFRSF13B*

mutations have been associated with both CVID and IgA deficiency. In particular, Salzer *et al.*³⁶ detected homozygous S144X mutations in a patient with hypogammaglobulinemia and hepatosplenomegaly; his brother, who was healthy, carried the same mutations and displayed lymphocytosis. The mutation inserts a stop codon in exon 3 and impairs the expression of the TACI protein and mRNA.³⁶ In line with this, Pt1 displayed a borderline expression of TACI in B cells. Pt1 also carried a second mutation (C193R) in exon 4 of the same allele, but this should be irrelevant as it is located downstream of the inserted stop codon. S144X seems non-penetrant in heterozygosity as shown both by Salzer *et al.*³⁶ and by our analysis of heterozygous patients M1 and S1b. Therefore, the finding that Pt1 is the only member of the family with both S144X and *CASP9*^{H237P} suggests that the two mutations may have cooperated in the disease development of Pt1, possibly through the borderline expression of TACI and the decreased expression of BAFFR and ICOS, which are all involved in B-cell function.

Pt2 carried a heterozygous mutation of *PRF1* coding for perforin, which is stored in the lytic granules of cytotoxic cells and involved in cell-mediated cytotoxicity.^{33,34} Biallelic *PRF1* mutations cause FHL, an immunodeficiency characterized by hemophagocytosis, fever, hepatosplenomegaly, cytopenia, hypertriglyceridemia, hypofibrinogenemia, frequent nervous system involvement and

increased frequency of lymphomas.³³ The disease is ascribed to the decreased capacity of cytotoxic cells to clear viral infections, whose persistence may support the lymphoproliferative picture. FHL is a recessive disease and subjects carrying heterozygous *PRF1* mutations are generally healthy; however, inherited *PRF1* mutations have also been associated with the development of lymphomas and ALPS.³⁷ In lymphomas, they can be either heterozygous or homozygous, whereas they are heterozygous in ALPS but are associated with inherited defects that affect Fas function. A similar role as a risk factor for ALPS has also been described for the *UNC13D* gene encoding for MUNC13-4, which is involved in perforin secretion and the development of a genetic variant of FHL.^{50,51} The N252S mutation has been detected in FHL, ALPS and lymphomas.^{33,37–39} It occurs within the membrane attack complex, a region critically involved in the pore-forming activity of perforin, but its functional significance has been debated because it has been associated with normal natural killer activity.⁵² In Pt2, a double caspase-9 and perforin defect may be involved in the development of his Burkitt lymphoma as both mutations may impair the immune response and favor lymphoproliferation.

The clinical phenotype of our heterozygous patients is very different from the high perinatal lethality, severe alteration of central nervous tissue development, and minor alterations of the immune system impairment displayed by the caspase-9^{-/-} mice. These differences, however, may reflect the residual caspase-9 activity displayed by our heterozygous patients and the cooperation of their second mutations.⁵³

In conclusion, our data show that caspase-9 is involved in both lymphocyte apoptosis and activation and that its defective activity can induce a clinical pattern of immunodeficiency and lymphoproliferation qualitatively similar to that induced by defective caspase-8 activity.

MATERIALS AND METHODS

Patients

We analyzed 136 unrelated Italian patients: 7 with autoimmunity, chronic lymphadenomegaly and/or splenomegaly and hypogammaglobulinemia, 78 with ALPS or DALD, lacking Fas, FasL, caspase-10 and caspase-8 mutations and 51 with primary hypogammaglobulinemia. ALPS/DALD patients were diagnosed using the criteria established at the 2009 ALPS NIH International Workshop.²⁴ A total of 140 healthy individuals were used as controls.

The study was planned according to the guidelines of the local ethical committee, Azienda Ospedaliera della Carità, of Novara that approved the study (Protocol 106/CE). Written, informed consent was signed by the patients or by their parents if they were minors.

Sequence analyses

Specific primers were used to amplify the exons and intron boundaries of *CASP9* (gene ID: 842), *FAS* (ID: 355), *FASL* (ID: 356), *CASP10* (ID: 843), *TNFRSF13B* (*TACI*) (ID: 23495), *TNFRSF13C* (*BAFFR*) (ID: 115650), *ICOS* (ID: 29851), *PRF1* (ID: 5551), *UNC13D* (ID: 201294), *STX11* (ID: 8676), *SH2D1A* (*SAP*) (ID: 4068) and *XIAP* (ID: 331) genes. The PCR products were sequenced with the ABI PRISM BigDye™ Terminator Kit (Applied Biosystems, Foster City, CA, USA) on an automatic sequencer, Applied Biosystems 3100 Genetic Analyzer (Applied Biosystems), using the same primers, except for exon 3 of *PRF1* for which we used also an internal primer.

Cells

PBMCs were obtained by density gradient centrifugation from patients' blood and buffy coats, provided by the local Blood Transfusion Service (Novara, Italy). Total CD4⁺ T cells from healthy controls were purified using the CD4⁺ T Cell Isolation Kit II (Miltenyi Biotec, Teterow, Germany). This approach provided >97% cells displaying the CD3⁺CD4⁺CD45RA⁺CD45RO⁺CD14⁻CD16⁻ phenotype, as assessed by direct immunofluorescence and flow cytometry. B cells were purified, after homogenization, by

density gradient centrifugation from the tonsils of patients undergoing tonsillectomy in the Otolaryngology Clinic of Azienda Ospedaliera della Carità, Novara, Italy. Cell surface markers were assessed by immunofluorescence and flow cytometry using the appropriate mAb to BAFFR (BioLegend, San Diego, CA, USA), ICOS (eBioscience, San Diego, CA, USA), B7h (R&D Systems, Minneapolis, MN, USA), TACI (BioLegend), CD19 (ImmunoTools, Friesoythe, Germany), CD3 (Becton Dickinson, Franklin Lakes, NJ, USA), CD4 (Sigma, St Louis, MO, Canada), CD8 (Invitrogen, Burlington, ON, Canada), CD25 (BioLegend) and HLA-DR (Becton Dickinson). In some experiments, cells were treated with Z-VAD-FMK (30 μM) (Enzo Life Sciences, Florence, Italy).

Antigenic density was expressed as the mean fluorescence intensity ratio, using the following formula: mean fluorescence intensity of sample histogram (arbitrary units)/mean fluorescence intensity of control histogram (arbitrary units).

Cell death assays

PBMCs (1×10^5) were incubated in flat-bottom 96-well plates with control medium (200 μl) with or without anti-Fas mAb ($0.5 \mu\text{g ml}^{-1}$) (CH11; UPSTATE Waltham, MA, USA) or with etoposide ($5 \mu\text{g ml}^{-1}$) (Sigma) in the presence of exogenous IL-2 (1 U ml^{-1}) to minimize spontaneous cell death. Eighteen hours later, the live cells were counted by the trypan blue exclusion test and live cells were detected using flow cytometry by excluding those cells that were propidium iodide (Becton Dickinson) and annexin V-FITC positive (Becton Dickinson); the two methods gave overlapping results. These assays were performed in duplicate. In some experiments, PBMCs were treated with Z-VAD-FMK (30 μM) (Enzo Life Sciences). In transfected human embryonic kidney 293T cells (ATCC; no. CRL-11268, Manassas, VA, USA), cell death assay was assessed 48 h after transfection, and in the last 18 h, etoposide ($5 \mu\text{g ml}^{-1}$) or no stimulus was added to the media of culture.

The specific cell loss % was calculated as follows: $100 - (\text{total live cell count in the assay well} / \text{total live cell count in the control well}) \times 100$.

Caspase-9, -3 and -8 activity was assessed in cell lysates using a fluorimetric assay (MBL, Watertown, MA, USA). At least three control samples, using PBMCs from different healthy donors, were run in parallel. In transfected human embryonic kidney 293T cells, caspase-9 activity was assessed 24 or 48 h after transfection to evaluate activation after treatment with etoposide ($5 \mu\text{g ml}^{-1}$) or spontaneous autoactivation, respectively.

PBMCs activation assays

PBMCs (1×10^5 per well) were cultured in flat-bottom 96-well microplates with RPMI 1640+10% fetal calf serum in the presence or absence of the appropriate stimulus. The anti-CD3 mAb (OKT3 $1 \mu\text{g ml}^{-1}$ in phosphate-buffered saline) (ATCC; no. CRL-8001) was precoated into the plates by overnight incubation at 4 °C. PHA and PWM (Sigma) were used at 1 and $10 \mu\text{g ml}^{-1}$, respectively. PBMC proliferation was assessed in triplicate by evaluating the uptake of [³H]TdR ($1 \mu\text{Ci}$ per well) (Perkin-Elmer, Waltham, MA, USA) in the last 6 h of culture on days 3 and 5 for OKT3- or PHA- and PWM-treated cells, respectively; the cells were harvested and radioactivity was detected with a β-counter (Perkin-Elmer). IL-2 secretion was evaluated by performing an enzyme-linked immunosorbent assay on the day 3 culture supernatants (Becton Dickinson). In PWM- treated cells, IgG, IgM and IgA secretion was evaluated by enzyme-linked immunosorbent assay of the day 5 supernatants (Rockland, Gilbertsville, PA, USA). In some experiments, cells were treated with Z-VAD-FMK (30 μM) (Enzo Life Sciences).

Caspase-9 cloning and transfection

Total RNA was extracted from Pt1 PBMCs using the NucleoSpin RNA II Kit (Macherey-Nagel, Düren, Germany) and reverse transcribed with the ThermoScript RT-PCR System (Invitrogen, Milan, Italy). *CASP9* was amplified with the same reverse primer and with two alternative forward primers, one adding the HA-tag and the other the FLAG-tag. Because Pt1 was heterozygous for *CASP9*^{H237P}, both the wild-type (FLAG-tagged) and the mutated (HA-tagged) amplicons were obtained. These cDNAs were cloned into the pcDNA3.1 vector (Invitrogen) and sequenced.

The 293T cells were cultured in Dulbecco's modified essential medium (Invitrogen) supplemented with 10% fetal calf serum at 37 °C. A total of 3×10^6 cells were plated in 90 mm dishes and transfected with 15 μg of the empty vector, the WT^{FLAG} vector, the H237P^{HA} vector or a combination of them using the Lipofectamine 2000 Kit (Invitrogen).

PBMCs, CD4⁺ T cells, TonsBCs and Raji cells (ATCC; no. CCL-86) were cultured in RPMI 1640 medium+10% fetal calf serum and transfected using

the Amaxa Cell Line Nucleofactor Kit V (Lonza, Basel, Switzerland), according to the manufacturer's instructions. Briefly, 4 µg of each construct were co-transfected with 1 µg of the pEGFP vector (Invitrogen). Transfection efficiency was analyzed by cytofluorimetric evaluation of the proportion of GFP-expressing cells.

After 30 h, adherent and floating cells were harvested into ice-cold AKT buffer (20 mM Tris, pH 7.5, 5 mM ethylenediaminetetraacetic acid, 150 mM NaCl, 1% Triton X-100, 10% glycerol, 0.5 mM dithiothreitol, 1 mM phenylmethanesulfonyl fluoride), 1 µg ml⁻¹ leupeptin, 1 µg ml⁻¹ aprotinin, 1 µg ml⁻¹ pepstatin for 20 min and sonicated three times. Cell debris was removed by centrifugation and equal amounts of the cleared lysates were heated for 5 min at 95 °C.

Western blotting and immunoprecipitation

Protein extracts from 293T cells and PBMCs were separated by sodium dodecyl sulfate-polyacrylamide gel electrophoresis, transferred to Hybond-C extra membranes (Amersham Pharmacia Biotech, Piscataway, NJ, USA), blotted with anti-caspase-9 (1 µg ml⁻¹) (Sigma), anti-HA (0.5 µg ml⁻¹) (Millipore, Billerica, MA, USA), anti-FLAG (1 µg ml⁻¹) (Sigma), anti-APAF-1 (1 µg ml⁻¹) (Sigma), anti-p27^{KIP1} (1 µg ml⁻¹) (Sigma) or anti-actin (0.5 µg ml⁻¹) (Sigma). A peroxidase-conjugated anti-mouse or anti-rabbit (GE Healthcare, Piscataway, NJ, USA) were used as a secondary antibody (GE Healthcare) and revealed by chemiluminescence.

In the immunoprecipitation experiments, transfected 293T cells were lysed in IPB buffer (10 mM Tris-HCl, pH 7.5, 150 mM NaCl, 1% NP40, 0.5% sodium deoxycholate, 1 mM phenylmethanesulfonyl fluoride, 1 µg ml⁻¹ leupeptin, 1 µg ml⁻¹ aprotinin, 1 µg ml⁻¹ pepstatin). Five micrograms of lysate was precleared with Sepharose-ProtG beads (GE Healthcare) and then incubated with 2 µg anti-caspase-9 mAb (Sigma), anti-HA mAb (Sigma) or the polyclonal anti-FLAG (Sigma) for 1 h at 4 °C and with 20 µl of protein G beads (GE Healthcare) for a further hour at 4 °C. Beads were washed three times, boiled in sodium dodecyl sulfate-polyacrylamide gel electrophoresis sample buffer, separated by sodium dodecyl sulfate-polyacrylamide gel electrophoresis and blotted with anti-APAF-1 (Sigma) and anti-caspase-9 (Sigma) antibodies.

Statistical analysis

Statistical analysis was performed using the analysis of variance followed by Dunnett's multiple comparison test, and paired *t*-test for analysis of transfected lymphocytes. The results are shown as the mean ± s.e. Genotype distributions were analyzed using the Fisher's exact test. All *P*-values are two-tailed, and the significance cutoff was **P* < 0.05 and ***P* < 0.01. Statistical analysis was performed with GraphPad Instat (GraphPad Software, San Diego, CA, USA) software.

CONFLICT OF INTEREST

The authors declare no conflict of interest.

ACKNOWLEDGEMENTS

This work was partially supported by Associazione Italiana Ricerca sul Cancro (AIRC, Milan; funding number #14430), Fondazione Cariplo (Milan), Fondazione Italiana Sclerosi Multipla (FISM, Rome), Compagnia di San Paolo (Turin), Fondazione Cassa di Risparmio di Cuneo (Cuneo), Regione Piemonte (Turin) and Associazione 'Amici di Jean' (Turin). We thank Dr Michael Lenardo and Dr Frederic Rieux-Laucat for providing some patients' DNA.

REFERENCES

- Nagata S. Apoptosis by death factor. *Cell* 1997; **88**: 355–365.
- Cohen GM. Caspases: the executioners of apoptosis. *J Biochem* 1997; **326**: 1–16.
- Dianzani U, Chiochetti A, Ramenghi UX. Role of inherited defects decreasing Fas function in autoimmunity. *Life Sci* 2003; **72**: 2803–2824.
- Zou H, Li Y, Liu X, Wang X. An APAF-1-cytochrome *c* multimeric complex is a functional apoptosome that activates procaspase-9. *J Biol Chem* 1999; **274**: 11549–11556.
- Riedl SJ, Shi Y. Molecular mechanisms of caspase regulation during apoptosis. *Nat Rev Mol Cell Biol* 2004; **5**: 897–907.
- Li H, Zhu H, Xu CJ, Yuan J. Cleavage of BID by caspase 8 mediates the mitochondrial damage in the Fas pathway of apoptosis. *Cell* 1998; **94**: 491–501.

- Luo X, Budihardjo I, Zou H, Slaughter C, Wang X. Bid, a Bcl2 interacting protein, mediates cytochrome *c* release from mitochondria in response to activation of cell surface death receptors. *Cell* 1998; **94**: 481–490.
- Budd RC. Death receptors couple to both cell proliferation and apoptosis. *J Clin Invest* 2002; **109**: 437–441.
- Alam A, Cohen LY, Aouad S, Sekaly RP. Early activation of caspases during T lymphocyte stimulation results in selective substrate cleavage in nonapoptotic cells. *J Exp Med* 1999; **190**: 1879–1890.
- Netea MG, Lewis EC, Azam T, Joosten LA, Jaekal J, Bae SY *et al*. Interleukin-32 induces the differentiation of monocytes into macrophage-like cells. *Proc Natl Acad Sci USA* 2008; **105**: 3515–3520.
- Sordet O, Rébé C, Plenchette S, Zermati Y, Hermine O, Vainchenker W *et al*. Specific involvement of caspases in the differentiation of monocytes into macrophages. *Blood* 2002; **100**: 4446–4453.
- Kang TB, Ben-Moshe T, Varfolomeev EE, Pewzner-Jung Y, Yogev N, Jurewicz A *et al*. Caspase-8 serves both apoptotic and nonapoptotic roles. *J Immunol* 2004; **173**: 2976–2984.
- Yi CH, Yuan J. The Jekyll and Hyde functions of caspases. *Dev Cell* 2009; **16**: 21–34.
- Chun HJ, Zheng L, Ahmad M, Wang J, Speirs CK, Siegel RM *et al*. Pleiotropic defects in lymphocyte activation caused by caspase-8 mutations lead to human immunodeficiency. *Nature* 2002; **419**: 395–399.
- Salmena L, Lemmers B, Hakem A, Matsiyak-Zablocki E, Murakami K, Au PY *et al*. Essential role for caspase 8 in T-cell homeostasis and T-cell-mediated immunity. *Genes Dev* 2003; **17**: 883–895.
- Levkau B, Koyama H, Raines EW, Clurman BE, Herren B, Orth K *et al*. Cleavage of p21Cip1/Waf1 and p27Kip1 mediates apoptosis in endothelial cells through activation of Cdk2: role of a caspase cascade. *Mol Cell* 1998; **1**: 553–563.
- Dohrman A, Kataoka T, Cuenin S, Russell JQ, Tschopp J, Budd RC. Cellular FLIP (long form) regulates CD8+ T cell activation through caspase-8-dependent NF-κB activation. *J Immunol* 2005; **174**: 5270–5278.
- Su H, Bidere N, Zheng L, Cubre A, Sakai K, Dale J *et al*. Requirement for caspase-8 in NF-κB activation by antigen receptor. *Science* 2005; **307**: 1465–1468.
- Woo M, Hakem R, Furlonger C, Hakem A, Duncan GS, Sasaki T *et al*. Caspase-3 regulates cell cycle in B cells: a consequence of substrate specificity. *Nat Immunol* 2003; **4**: 1016–1022.
- Wang J, Zheng L, Lobito A, Chan FK, Dale J, Sneller M *et al*. Inherited human caspase 10 mutations underlie defective lymphocyte and dendritic cell apoptosis in autoimmune lymphoproliferative syndrome type II. *Cell* 1999; **98**: 47–58.
- Fisher GN, Rosenberg FJ, Straus SE, Dale JK, Middleton LA, Lin AY *et al*. Dominant interfering Fas gene mutations impair apoptosis in a human lymphoproliferative syndrome. *Cell* 1995; **81**: 935–946.
- Rieux-Laucat F, Le Deist F, Hivroz C, Roberts IA, Debatin KM, Fischer A *et al*. Mutations in Fas associated with human lymphoproliferative syndrome and autoimmunity. *Science* 1995; **268**: 1347–1349.
- Wu J, Wilson J, He J, Xiang L, Schur PH, Mountz JD. Fas ligand mutation in a patient with systemic lupus erythematosus and lymphoproliferative disease. *J Clin Invest* 1996; **98**: 1107–1113.
- Oliveira JB, Bleesing JJ, Dianzani U, Fleisher TA, Jaffe ES, Lenardo MJ *et al*. Revised diagnostic criteria and classification for the autoimmune lymphoproliferative syndrome (ALPS): report from the 2009 NIH International Workshop. *Blood* 2010; **116**: e35–e40.
- Dianzani U, Bragardo M, Di Franco D, Alliaudi C, Scagni P, Buonfiglio D *et al*. Deficiency of the Fas apoptosis pathway without Fas gene mutations in pediatric patients with autoimmunity/lymphoproliferation. *Blood* 1997; **89**: 2871–2879.
- Ramenghi U, Bonisconi S, Migliaretti G, DeFranco S, Bottarel F, Gambarato C *et al*. Deficiency of the Fas apoptosis pathway without Fas gene mutations is a familial trait predisposing to development of autoimmune diseases and cancer. *Blood* 2000; **95**: 3176–3182.
- Campagnoli MF, Gambarini L, Quarello P, Garelli E, Carando A, Baravalle V *et al*. The broad spectrum of autoimmune lymphoproliferative disease: molecular bases, clinical features and long-term follow-up in 31 patients. *Haematologica* 2006; **91**: 538–541.
- Cunningham-Rundles C, Bodian C. Common variable immunodeficiency: clinical and immunological features of 248 patients. *Clin Immunol* 1999; **92**: 34–48.
- Park MA, Li JT, Hagan JB, Maddox DE, Abraham RS. Common variable immunodeficiency: a new look at an old disease. *Lancet* 2008; **372**: 489–502.
- Warnatz K, Schlesier M. Flow cytometric phenotyping of common variable immunodeficiency. *Cytometry B Clin Cytom* 2008; **74**: 261–271.
- Rensing-Ehl A, Warnatz K, Fuchs S, Schlesier M, Salzer U, Draeger R *et al*. Clinical and immunological overlap between autoimmune lymphoproliferative syndrome and common variable immunodeficiency. *Clin Immunol* 2010; **137**: 357–365.
- Park JH, Resnick ES, Cunningham-Rundles C. Perspectives on common variable immune deficiency. *Ann NY Acad Sci* 2011; **1246**: 41–49.

- 33 Gholam C, Grigoriadou S, Gilmour KC, Gaspar HB. Familial haemophagocytic lymphohistiocytosis: advances in the genetic basis, diagnosis and management. *Clin Exp Immunol* 2011; **163**: 271–283.
- 34 Voskoboinik I, Dunstone MA, Baran K, Whisstock JC, Trapani JA. Perforin: structure, function, and role in human immunopathology. *Immunol Rev* 2010; **235**: 35–54.
- 35 Rezaei N, Mahmoudi E, Aghamohammadi A, Das R, Nichols KE. X-linked lymphoproliferative syndrome: a genetic condition typified by the triad of infection, immunodeficiency and lymphoma. *Br J Haematol* 2011; **152**: 13–30.
- 36 Salzer U, Chapel HM, Webster AD, Pan-Hammarstrom Q, Schmitt-Graeff A, Schlesier M *et al*. Mutations in TNFRSF13B encoding TACI are associated with common variable immunodeficiency in humans. *Nat Genet* 2005; **37**: 820–828.
- 37 Clementi R, Chiochetti A, Cappellano G, Cerutti E, Ferretti M, Orilieri E *et al*. Variations of the perforin gene in patients with autoimmunity/lymphoproliferation and defective Fas function. *Blood* 2006; **108**: 3079–3084.
- 38 Clementi R, Locatelli F, Dupre L, Garaventa A, Emmi L, Bregni M *et al*. A proportion of patients with lymphoma may harbor mutations of the perforin gene. *Blood* 2005; **105**: 4424–4428.
- 39 Orilieri E, Cappellano G, Clementi R, Cometa A, Ferretti M, Cerutti E *et al*. Variations of the perforin gene in patients with type 1 diabetes. *Diabetes* 2008; **57**: 1078–1083.
- 40 Rensatus M, Stennicke HR, Scott FL, Liddington RC, Salvesen GS. Dimer formation drives the activation of the cell death protease caspase 9. *Proc Natl Acad Sci USA* 2001; **98**: 14250–14255.
- 41 Adams JM, Cory S. Apoptosomes: engines for caspase activation. *Curr Opin Cell Biol* 2002; **14**: 715–720.
- 42 Pop C, Timmer J, Sperandio S, Salvesen GS. The apoptosome activates caspase-9 by dimerization. *Mol Cell* 2006; **22**: 269–275.
- 43 Ehrenfeld M, Abu-Shakra M, Buskila D, Shoenfeld Y. The dual association between lymphoma and autoimmunity. *Blood Cells Mol Dis* 2001; **27**: 750–756.
- 44 Oertel SH, Riess H. Immunosurveillance, immunodeficiency and lymphoproliferations. *Recent Results Cancer Res* 2002; **159**: 1–8.
- 45 Muris JJ, Cillessen SA, Vos W, van Houdt IS, Kummer JA, van Krieken JH *et al*. Immunohistochemical profiling of caspase signaling pathways predicts clinical response to chemotherapy in primary nodal diffuse large B-cell lymphomas. *Blood* 2005; **105**: 2916–2923.
- 46 Shulga-Morskaya S, Dobles M, Walsh ME, Ng LG, MacKay F, Rao SP *et al*. B cell-activating factor belonging to the TNF family acts through separate receptors to support B cell survival and T cell-independent antibody formation. *J Immunol* 2004; **173**: 2331–2341.
- 47 Xu H, Li X, Liu D, Li J, Zhang X, Chen X *et al*. Follicular T-helper cell recruitment governed by bystander B cells and ICOS-driven motility. *Nature* 2013; **496**: 523–527.
- 48 Gross JA, Johnston J, Mudri S, Enselman R, Dillon SR, Madden K *et al*. TACI and BCMA are receptors for a TNF homologue implicated in B-cell autoimmune disease. *Nature* 2000; **404**: 995–999.
- 49 Seshasayee D, Valdez P, Yan M, Dixit VM, Tumas D, Grewal IS. Loss of TACI causes fatal lymphoproliferation and autoimmunity, establishing TACI as an inhibitory BlyS receptor. *Immunity* 2003; **18**: 279–288.
- 50 Boggio E, Aricò M, Melensi M, Dianzani I, Ramenghi U, Dianzani U *et al*. Mutation of FAS, XIAP, and UNC13D genes in a patient with a complex lymphoproliferative phenotype. *Pediatrics* 2013; **132**: e1052–e1058.
- 51 Aricò M, Boggio E, Cetica V, Melensi M, Orilieri E, Clemente N *et al*. Variations of the UNC13D gene in patients with autoimmune lymphoproliferative syndrome. *PLoS One* 2013; **8**: e68045.
- 52 Voskoboinik I, Thia MC, Trapani JA. A functional analysis of the putative polymorphisms A91V and N252S and 22 missense perforin mutations associated with familial hemophagocytic lymphohistiocytosis. *Blood* 2005; **105**: 4700–4706.
- 53 Zheng TS, Hunot S, Kuida K, Flavell RA. Caspase knockouts: matters of life and death. *Cell Death Differ* 1999; **6**: 1043–1053.

Supplementary Information accompanies this paper on Genes and Immunity website (<http://www.nature.com/gene>)