

Identification of Pilot Performance Parameters for Human Performance Models of Off-Nominal Events in the NextGen Environment

Brian F. Gore, Becky L. Hooey
San Jose State University Research Foundation, San Jose, CA
Ames Research Center Moffett Field, CA

Christopher D. Wickens, Angelia Sebok, Shaun Hutchins
Alion Science and Technology

Ellen Salud
San Jose State University Research Foundation, San Jose, CA
Ames Research Center Moffett Field, CA

Ronald Small, Corey Koenecke, & Julie Bzostek
Alion Science and Technology

NASA STI Program...in Profile

Since its founding, NASA has been dedicated to the advancement of aeronautics and space science. The NASA scientific and technical information (STI) program plays a key part in helping NASA maintain this important role.

The NASA STI program operates under the auspices of the Agency Chief Information Officer. It collects, organizes, provides for archiving, and disseminates NASA's STI. The NASA STI program provides access to the NASA Aeronautics and Space Database and its public interface, the NASA Technical Report Server, thus providing one of the largest collections of aeronautical and space science STI in the world. Results are published in both non-NASA channels and by NASA in the NASA STI Report Series, which includes the following report types:

- **TECHNICAL PUBLICATION.** Reports of completed research or a major significant phase of research that present the results of NASA Programs and include extensive data or theoretical analysis. Includes compilations of significant scientific and technical data and information deemed to be of continuing reference value. NASA counterpart of peer-reviewed formal professional papers but has less stringent limitations on manuscript length and extent of graphic presentations.
- **TECHNICAL MEMORANDUM.** Scientific and technical findings that are preliminary or of specialized interest, e.g., quick release reports, working papers, and bibliographies that contain minimal annotation. Does not contain extensive analysis.

- **CONTRACTOR REPORT.** Scientific and technical findings by NASA-sponsored contractors and grantees.
- **CONFERENCE PUBLICATION.** Collected papers from scientific and technical conferences, symposia, seminars, or other meetings sponsored or co-sponsored by NASA.
- **SPECIAL PUBLICATION.** Scientific, technical, or historical information from NASA programs, projects, and missions, often concerned with subjects having substantial public interest.
- **TECHNICAL TRANSLATION.** English-language translations of foreign scientific and technical material pertinent to NASA's mission.

Specialized services also include creating custom thesauri, building customized databases, and organizing and publishing research results.

For more information about the NASA STI program, see the following:

- Access the NASA STI program home page at <http://www.sti.nasa.gov>
- E-mail your question via the Internet to help@sti.nasa.gov
- Fax your question to the NASA STI Help Desk at (301) 621-0134
- Phone the NASA STI Help Desk at (301) 621-0390
- Write to:
NASA STI Help Desk
NASA Center for AeroSpace Information
7121 Standard Drive
Hanover, MD 21076-1320

NASA/CR—2010-216411

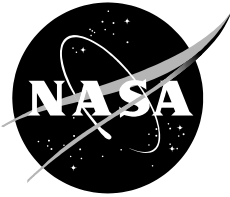

Identification of Pilot Performance Parameters for Human Performance Models of Off-Nominal Events in the NextGen Environment

Brian F. Gore, Becky L. Hooey
San Jose State University Research Foundation, San Jose, CA
Ames Research Center Moffett Field, CA

Christopher D. Wickens, Angelia Sebok, Shaun Hutchins
Alion Science and Technology

Ellen Salud
San Jose State University Research Foundation, San Jose, CA
Ames Research Center Moffett Field, CA

Ronald Small, Corey Koenecke, & Julie Bzostek
Alion Science and Technology

National Aeronautics and Space Administration
Ames Research Center
Moffett Field, California 94037

December 2010

Acknowledgements

Phase 1 of the research, ASDO Concept Development and Scenario Specification, was led by Angelia Sebok and Ken Leiden from Alion Science and Technology with contributions from Ronald Small, Christopher Wickens, and Shaun Hutchins from Alion and Becky Hooey, Ellen Salud, and Brian Gore from San Jose State University Research Foundation.

Phase 2 of the research, Off-nominal parameter meta-analysis, was led by Becky Hooey from San Jose State University with contributions from Ellen Salud and Brian Gore from San Jose State University Research Foundation and Christopher Wickens, Angelia Sebok, and Shaun Hutchins from Alion Science and Technology.

Phase 3 of the research, N-SEEV modeling, was led by Christopher Wickens from Alion Science and Technology with contributions from Angelia Sebok, Corey Koenecke, and Julie Bzostek from Alion Science and Technology and Becky Hooey and Brian Gore from San Jose State University Research Foundation.

The authors thank the following for their time, effort, and contributions to this project and for sharing their knowledge, research, and insights into NextGen operations: Dave Foyle (COTR), John Robinson, Doug Isaacson, Todd Callantine, Ev Palmer, Tom Prevot, Savvy Verma, Gordon Hardy, Nancy Smith, Walt Johnson, and Vern Battiste, Richard Shay, and Brett Warden. We also thank the pilots who participated in the Phase 1 focus group and Flight Research Associates for their assistance in recruiting the pilot participants.

The use of trademarks or names of manufacturers in the report is for accurate reporting and does not constitute an official endorsement, either expressed or implied, of such products or manufacturers by the National Aeronautics and Space Administration.

Available from:

NASA Center for AeroSpace Information
7121 Standard Drive
Hanover, MD 21076-1320
(301) 621-0390

NASA Center for Aerospace Information
7121 Standard Drive
Hanover, MD 21076-1320
(301) 621-0390

Table of Contents

| | |
|---|-----------|
| Chapter 1. Introduction | 1 |
| Chapter 2. Phase 1: ASDO Concept Development and Scenario Specification | 4 |
| 2.1 Introduction | 4 |
| 2.2 Methods | 5 |
| 2.3 Description of Current-Day System..... | 9 |
| 2.3.1 Arrival, Approach, Landing, and Departure Phases of Flight..... | 9 |
| 2.3.2 Flight Deck Controls, Instrumentation, and Displays | 10 |
| 2.3.2.1 Flight Management System | 11 |
| 2.3.2.2 Mode Control Panel | 13 |
| 2.3.2.3 Primary Flight Display | 14 |
| 2.3.2.4 Navigation Display | 16 |
| 2.3.2.5 Electronic Flight Instrument System | 17 |
| 2.3.2.6 Display Select Panel | 18 |
| 2.3.2.7 Pedestal | 19 |
| 2.3.3 Flight Crew..... | 20 |
| 2.4 Current Day Nominal Scenarios | 21 |
| 2.4.1 Arrival / Approach | 21 |
| 2.4.2 Departure..... | 24 |
| 2.5 Description of NextGen Super Density Operations..... | 27 |
| 2.5.1 NextGen Concepts | 27 |
| 2.5.2 Assumptions Regarding NextGen Displays..... | 29 |
| 2.6 NextGen Approach / Arrival Scenarios..... | 36 |
| 2.6.1 Nominal Arrival | 36 |
| 2.6.2 Off-Nominal Arrival | 39 |
| 2.6.3 Focus Group Results | 58 |
| 2.7 NextGen Departure Scenarios..... | 59 |
| 2.7.1 Nominal Departure..... | 59 |
| 2.7.2 Off-Nominal Departure | 61 |
| 2.7.3 Focus Group Results | 70 |
| 2.8 Summary and Conclusions | 71 |
| Chapter 3. Phase 2: Parameter Meta-Analysis of Off-nominal HITL Studies..... | 72 |
| 3.1 Introduction | 72 |
| 3.2 Method..... | 73 |
| 3.2.1 Selection Criteria..... | 73 |
| 3.2.2 Technical Approach to Analyses | 75 |
| 3.3 Results – Miss Rate Analyses..... | 75 |
| 3.3.1 Off-Nominal Event Characteristics: Phase of Flight, Expectancy and Event Location | 76 |
| 3.3.2 Flight Deck Technology Factors..... | 77 |
| 3.4 Results – Response Latency Analyses..... | 82 |
| 3.5 Conclusion | 83 |
| 3.5.1 Summary | 83 |
| 3.5.2 Limitations and Opportunities for Future Research..... | 85 |
| 3.5.2.1 Small Sample Size | 85 |
| 3.5.2.2 Data Were Limited to Simulation Studies | 86 |
| 3.5.2.3 Data Included Studies with Single-Pilot Crews..... | 86 |
| 3.5.2.4 Data Were Limited to a Specific Class of Off-Nominals | 86 |
| 3.5.3 Next Steps | 87 |

| | |
|--|------------|
| Chapter 4. Phase 3: Predicting NextGen Performance with N-SEEV | 88 |
| 4.1 Introduction | 88 |
| 4.2 SEEV Model..... | 89 |
| 4.2.1 SEEV Parameters | 90 |
| 4.2.2 How the Model Works | 90 |
| 4.2.3 Level of Detail..... | 91 |
| 4.3 Noticing SEEV (N-SEEV) Model..... | 91 |
| 4.4 Validation Against Meta-Analysis Miss Rate Data | 92 |
| 4.5 Sensitivity Analysis for Parameter Changes..... | 99 |
| 4.6 Predictions for NextGen Technology and Procedures..... | 99 |
| 4.6.1 NextGen Approach Scenarios with and without an Electronic Flight Bag..... | 100 |
| 4.6.2 NextGen Takeoff / Departure Scenarios | 101 |
| 4.6.3 NextGen Scenarios with Increased Pilot Self-Separation Responsibilities | 103 |
| 4.6.4 Very Closely Spaced Parallel Approaches..... | 105 |
| 4.6.5 Airborne Taxi Clearances | 106 |
| 4.7 Summary | 107 |
| 4.8 Discussion | 108 |
| 4.9 Future Research..... | 109 |
| 4.9.1 Parameter Setting | 109 |
| 4.9.2 Speed – Accuracy Tradeoff: Noticing Time vs. Miss Rate | 110 |
| 4.9.3 Single Pilot Modeling | 111 |
| 4.9.4 Separate Effect of Effort | 111 |
| 4.9.5 Visual Attention Only | 111 |
| Chapter 5. Conclusion..... | 112 |
| 5.1 Current-Day and NextGen Task Analyses for Approach and Departure | 112 |
| 5.2 Identification of Off-Nominal Scenarios for NextGen ASDO Operations..... | 112 |
| 5.3 Comprehensive Data Set of Human Performance Responses to Off-Nominal Events | 112 |
| 5.4 Validated N-SEEV Model..... | 113 |
| 5.5 Performance Predictions for NextGen Scenarios..... | 113 |
| 5.6 Research Methods to Predict the Unpredictable..... | 114 |
| 5.7 Summary | 114 |
| 5.8 Final Words..... | 115 |
| Chapter 6. References | 116 |
| Appendix A. Phase 1 Bibliography of Materials Relevant to NextGen Operations | 123 |
| Appendix B. Phase 1 Current Day Arrival Scenario Task Analysis | 128 |
| Appendix C. Phase 1 Current Day Departure Scenario Task Analysis | 189 |
| Appendix D. Phase 1 Presentation Delivered to the Pilot Focus Group | 202 |
| Appendix E. Phase 1 Summary of the Demographic Data from the Pilot Focus Group..... | 216 |
| Appendix F. Phase 1 Summary of Input from the ATC SME | 218 |
| Appendix G. Phase 1 Table of Off-Nominal Events and Contributing Factors..... | 220 |
| Appendix H. Phase 1 Comprehensive List of Off-Nominal Event Ratings..... | 231 |
| Appendix I. Phase 2 List of All Off-Nominal Studies Identified..... | 235 |
| Appendix J. Phase 2 Coded List of Off-Nominal Studies Used in Analyses | 242 |
| Appendix K. NRA NNX08AE87A Generated Publications | 246 |

List of Figures

| | |
|---|----|
| Figure 1.1. Interaction amongst Phases 1) Scenario Specification, 2) Parameter Meta-Analysis, and 3) N-SEEV Validation and Predictions..... | 3 |
| Figure 2.1. Normal Phases of Flight | 9 |
| Figure 2.2. A B-777 Flight Deck..... | 11 |
| Figure 2.3. A B-777 Forward Instrument Panel..... | 12 |
| Figure 2.4. A B-777 Mode Control Panel | 13 |
| Figure 2.5. A Primary Flight Display..... | 15 |
| Figure 2.6. A Navigation Display | 16 |
| Figure 2.7. The Electronic Flight Instrument System | 18 |
| Figure 2.8. A Display Select Panel | 19 |
| Figure 2.9. A B-777 Pedestal | 20 |
| Figure 2.10. Current-day Nominal Arrival Scenario..... | 24 |
| Figure 2.11. Current-day Departure Scenario | 26 |
| Figure 2.12. A Boeing 787 Flight Deck, Showing Displays and Layouts Relevant for NextGen..... | 30 |
| Figure 2.13. A Boeing 787 Flight Deck Layout, Including a VSD and Surface Map. | 31 |
| Figure 2.14. A Boeing 787 Flight Deck Layout, Including Integrated Weather Displays and Navigation Performance Data.. | 31 |
| Figure 2.15. A Boeing 787 Flight Deck Layout, Including a Synthetic Vision System, an Enhanced Vision System (Camera Views), Taxi Guidance, and Terrain Data on the PFD | 32 |
| Figure 2.16. The Electronic Flight Bag on a Boeing 787 Flight Deck.. | 32 |
| Figure 2.17. A Potential Surface Map Display Taxiway Navigation and Situation Awareness (T-NASA) Display. | 33 |
| Figure 2.18. A potential PFD with integrated navigation performance data. | 33 |
| Figure 2.19. A Potential Vertical Situation Display..... | 34 |
| Figure 2.20. Potential Wake Vortex Displays..... | 34 |
| Figure 2.21. Potential Cockpit Display of Traffic Information (CDTI) may be implemented as 2-D (top), or 3-D (bottom)..... | 35 |
| Figure 2.22. Nominal Event NextGen Approach/Arrival Scenario | 38 |
| Figure 2.23. A NextGen Arrival Scenario with Nominal and Off-Nominal (ON) Events | 40 |
| Figure 2.24. Murphy Diagram of NextGen Arrival / Approach Off-Nominal 1 | 45 |
| Figure 2.25. Murphy Diagram of NextGen Arrival / Approach Off-Nominal 2 | 46 |
| Figure 2.26. Murphy Diagram of NextGen Arrival / Approach Off-Nominal 3 | 47 |
| Figure 2.27. Murphy Diagram of NextGen Arrival / Approach Off-Nominal 4 | 48 |
| Figure 2.28. Murphy Diagram of NextGen Arrival / Approach Off-Nominal 5 | 49 |
| Figure 2.29. Murphy Diagram of NextGen Arrival / Approach Off-Nominal 6 | 50 |
| Figure 2.30. Murphy Diagram of NextGen Arrival / Approach Off-Nominal 7 | 51 |
| Figure 2.31. Murphy Diagram of NextGen Arrival / Approach Off-Nominal 8 | 52 |
| Figure 2.32. Murphy Diagram of NextGen Arrival / Approach Off-Nominal 9 | 53 |
| Figure 2.33. Murphy Diagram of NextGen Arrival / Approach Off-Nominal 10 | 54 |
| Figure 2.34. Murphy Diagram of NextGen Arrival / Approach Off-Nominal 11 | 55 |
| Figure 2.35. Murphy Diagram of NextGen Arrival / Approach Off-Nominal 12 | 56 |
| Figure 2.36. Murphy Diagram of NextGen Arrival / Approach Off-Nominal 13 | 57 |
| Figure 2.37. NextGen Nominal Departure | 60 |
| Figure 2.38. A NextGen Departure Scenario, with Nominal and Off-nominal Events | 61 |

List of Figures

Figure 2.39. Murphy Diagram of NextGen Departure Off-Nominal 162
Figure 2.40. Murphy Diagram of NextGen Departure Off-Nominal 263
Figure 2.41. Murphy Diagram of NextGen Departure Off-Nominal 364
Figure 2.42. Murphy Diagram of NextGen Departure Off-Nominal 465
Figure 2.43. Murphy Diagram of NextGen Departure Off-Nominal 566
Figure 2.44. Murphy Diagram of NextGen Departure Off-Nominal 667
Figure 2.45. Murphy Diagram of NextGen Departure Off-Nominal 768
Figure 2.46. Murphy Diagram of NextGen Departure Off-Nominal 869
Figure 4.1. Cockpit layout with 15 Areas of Interest (AOI).93
Figure 4.2. Stacked bar graph showing the percent dwell time (PDT) in key areas of interest for
HITS (left) and non-HITS (right) trials.....96
Figure 4.3. Model Predicted and Meta-analysis Obtained Miss Rate, associated with the Expectancy
Effect, HITS Cost, and Cockpit Location Cost.....98

List of Tables

| | |
|---|-----|
| Table 1.1. Potential Off-Nominal Events in the ASDO Transitional Airspace | 2 |
| Table 2.1. Perceived Safety Impact for Off-Nominals in NextGen Arrivals / Approaches..... | 59 |
| Table 2.2. Perceived Efficiency Impact for Off-Nominals in NextGen Arrivals / Approaches | 59 |
| Table 2.3. Perceived Safety Impact for Off-Nominal Events in NextGen Departures | 70 |
| Table 2.4. Perceived Efficiency Impact for Off-Nominal Events in NextGen Departures..... | 71 |
| Table 3.1. Phase of Flight Main Effect | 76 |
| Table 3.2. Event Expectancy Main Effect..... | 76 |
| Table 3.3. Event Location Main Effect | 77 |
| Table 3.4. Event Expectancy by Event Location Interaction | 77 |
| Table 3.5. HUD Use Main Effect..... | 78 |
| Table 3.6. HUD Use X Event Expectancy Interaction..... | 78 |
| Table 3.7. HUD Use X Event Location Interaction | 78 |
| Table 3.8. HITS Use Effects | 79 |
| Table 3.9. HUD Use by HITS Use Interaction | 79 |
| Table 3.10. Clearance Delivery Main Effect..... | 80 |
| Table 3.11. Datalink X Error Type Interaction | 80 |
| Table 3.12. Graphical Route Main Effect | 81 |
| Table 3.13. Graphical Route X Error Type Interaction..... | 81 |
| Table 3.14. Delivery Method as Moderated by Graphical Route Displays | 82 |
| Table 4.1. Parameters for Four Model Runs | 95 |
| Table 4.2. Model-Predicted Miss Rates as a Function of Event Location and Salience..... | 97 |
| Table 4.3. Model-predicted Miss Rates as a Function of Event Location (Runs 8-10) and Salience (Runs 11-13)..... | 99 |
| Table 4.4. Value and Bandwidth (BW) Parameters and Percent Dwell Time (PDT) for an Automated Cockpit During Approach Phase (shown here with the EFB not in use)..... | 100 |
| Table 4.5a. Miss Rate Data with a NextGen Automated Cockpit on Approach with and without an EFB as a Function of Off-Nominal Event Location | 101 |
| Table 4.5b. Response Time Data with a NextGen Automated Cockpit on Approach with and without an EFB as a Function of Off-Nominal Event Location..... | 101 |
| Table 4.6. Parameter Values for Takeoff (left) and Departure (right) Scenarios..... | 102 |
| Table 4.7a. Take-off and Departure Miss Rates as a Function of Event Location | 103 |
| Table 4.7b. Take-off and Departure Noticing Time as a Function of Event Location | 103 |
| Table 4.8a. Self-separation Miss Rates | 104 |
| Table 4.8b. Self-Separation Noticing Times | 104 |
| Table 4.9. Very Closely Spaced Parallel Approaches (VCSPA) Parameters | 105 |
| Table 4.10a. Very Closely Spaced Parallel Approaches (VCSPA) Miss Rates..... | 106 |
| Table 4.10b. Very Closely Spaced Parallel Approaches (VCSPA) Noticing Times | 106 |
| Table 4.11a. Airborne Taxi Clearance Miss Rates..... | 106 |
| Table 4.11b. Airborne Taxi Clearance Noticing Times | 107 |
| Table 4.12. Mean Time and Miss Rate Master Summary of all Model Runs, Research Phase, Scenario and Off Nominal Event Description..... | 107 |

Acronyms

| Acronym | Definitions |
|----------|--|
| 4D | Four Dimension (Latitude, Longitude, Altitude, and Time) |
| 4DT | Four Dimensional Trajectory |
| A/P | Autopilot |
| A/T | Autothrottle(s) |
| AC | Aircraft |
| ADI | Attitude Direction Indicator |
| ADS-B | Automatic Dependent Surveillance Broadcast |
| ADS-X | Automatic Dependent Surveillance (Future) |
| AGL | Above Ground Level |
| Alt | Altitude |
| AOI | Area of Interest |
| APP | Approach Mode |
| ARMED | Aeronautics Research Mission Directorate |
| ARPT | Airport(s) |
| ASDE | Airport Surface Detection Equipment |
| ASDO | Airspace Super Density Operations |
| ASTA | Airport Surface Traffic Automation |
| ATC | Air Traffic Control |
| ATIS | Air Terminal Information Service |
| ATM | Air Traffic Management |
| B-777 | Boeing-777 |
| BW | Bandwidth |
| CANC/RCL | Cancel/Recall |
| CAP | Captain |
| CCD | Cursor Control Device |
| CDTI | Cockpit Display of Traffic Information |
| CDU | Control Display Unit |
| COTR | Contract Officer Technical Representative |
| CSPA | Closely Spaced Parallel Approaches |
| DATA | Distance and Time Available |
| ECON | Economic |
| EF | Effort |
| EFB | Electronic Flight Bag |
| EFIS | Electronic Flight Instrument System |
| EICAS | Engine Indicating and Crew Alert System |
| EVO | Equivalent Visual Operations |
| EVS | Enhanced Vision System |
| EX | Expectancy |

| Acronym | Definitions |
|---------|--|
| F/D | Flight Director |
| F/O | First Officer |
| FAA | Federal Aviation Administration |
| FDMS | Flight Deck Merging and Spacing |
| FE | First Event |
| FL | Flight Level |
| FL CH | Flight Level Change |
| FMA | Flight Mode Annunciator |
| FMC | Flight Management Computer |
| FMS | Flight Management System |
| FOV | Field of View |
| FPM | Feet per Minute |
| GA | General Aviation |
| GPS | Global Positioning System |
| GS | Ground Speed |
| HAR | Height Above Runway |
| HDG | Heading |
| HITL | Human-in-the-Loop |
| HITS | Highway-in-the-Sky |
| HNL | Honolulu International Airport |
| HPM | Human Performance Model |
| HUD | Head-Up Display |
| IAS | Indicated Airspeed |
| ID | Identification |
| IFR | Instrument Flight Rules |
| IIFDT | Integrated Intelligent Flight Deck Technologies |
| ILS | Instrument Landing System |
| IMC | Instrument Meteorological Conditions |
| IOR | Inhibition of Return |
| JPDO | Joint Planning And Development Office |
| Knot | Nautical Mile Per Hour |
| Lat | Latitude |
| LNAV | Lateral Navigation |
| LOC | Localizer |
| Lon | Longitude |
| M | Mean |
| Mach | Airspeed Relative to the (Local) Speed of Sound |
| MCP | Mode Control Panel |
| MCW | Master Caution and Warning Light |
| MIDAS | Man-Machine Integration Design and Analysis System |

| Acronym | Definitions |
|-----------|--|
| NAS | National Airspace System |
| NASA | National Aeronautics Space Administration |
| ND | Navigational Display |
| NextGen | Next Generation [Air Transportation System] |
| NGATS | Next Generation Air Transportation System |
| Nm | Nautical Mile(s) |
| NORCAL | Northern California Approach and Departure Control (ATC) |
| NRA | NASA Research Announcement |
| NT | Noticing Time |
| ON | Off-Nominal |
| OTW | Out the Window |
| OW | Out the Window |
| P(Notice) | Noticing Probability |
| PAM | Parallel Approach Monitoring |
| PDT | Percent Dwell Time |
| PF | Pilot Flying |
| PFD | Primary Flight Display |
| PIL | Pilot-in-the-Loop |
| Pmiss | Miss Rate |
| PNF | Pilot Not Flying |
| POS | Position |
| PRM | Precision Runway Monitor |
| RA | Resolution Advisory |
| RAAS | Runway Awareness and Advisory System |
| RNAV | Required Navigation |
| RNP | Required Navigation Performance |
| RT | Response Time |
| S | Salience |
| SA | Situational Awareness |
| SD | Standard Deviation |
| SDO | Super Density Operations |
| SEEV | Salience, Expectancy, Effort, and Value |
| SEL | Select |
| SFO | San Francisco International Airport |
| SID | Standard Instrument Departure |
| SME | Subject Matter Expert |
| Spd | Speed |
| STA | Station |
| STAR | Standard Arrival |
| SVS | Synthetic Vision System |

| Acronym | Definitions |
|----------------|--|
| TA | Traffic Advisory |
| TA/RA | Traffic Alert/Resolution Advisory |
| TACEC | Terminal Area Capacity Enhancing Concept |
| TAS | True Airspeed |
| TBNE | To-Be-Noticed-Event |
| TCAS | Traffic Collision Avoidance System |
| TERR | Terrain |
| TISB | Traffic Information Service Broadcast |
| TOC | Top of Climb |
| TOD | Top of Decent |
| TOGA | Takeoff/Go-Around |
| U.S. | United States |
| UAL | United Air Lines |
| V | Value |
| V/S | Vertical Speed |
| V ₁ | Velocity Speed 1 |
| V ₂ | Velocity Speed 2 |
| VCSPA | Very Closely Spaced Parallel Approach |
| VHF | Very High Frequency |
| VMC | Visual Meteorological Conditions |
| VNAV | Vertical Navigation |
| VOR | Vhf Omni-Directional Radio |
| V _R | Velocity rotate |
| VS | Vertical Speed |
| VSD | Vertical Situation Display |
| WPT | Waypoint |
| WV | Wake Vortex |
| WXR | Weather Radar |

CHAPTER 1. INTRODUCTION

“Super density operations” (SDO) is a term with several meanings within the air transportation research domain. It is one of eight key capabilities identified by the Joint Planning and Development Office that defines the proposed Next Generation Air Transportation System¹ (NextGen) vision (JPDO, 2007). NASA’s Airspace Super Density Operations (ASDO) concept provides highly efficient operations at the busiest airports and terminal airspace by utilizing trajectory-based operations that are robust to weather and other disturbances to meet the NextGen demands in super dense and regional/metroplex airspace while minimizing environmental impact (Isaacson, 2007). This includes the requirements for: (1) simultaneous sequencing and deconfliction technologies for trajectory management of aircraft in terminal airspace; (2) precision spacing and merging capabilities to reduce workload and spacing variance between aircraft in terminal and extended terminal airspace; and (3) methods for optimizing resource utilization among interconnected airports.

Given the reduced aircraft separation buffers and the additional requirements that are being placed on the operators, the ASDO concept is ripe with opportunity for off-nominal events to occur that could threaten both the efficiency and safety of ASDO operations. These off-nominal events may range from ‘less-likely but necessary’ operations that are slightly outside the range of normal operations (such as weather, turbulence, windshear events) to very rare events (such as partial or full equipment failures and security breaches). An inappropriate response to an off-nominal event can lead to a cascading effect in the system and disrupt the entire airspace flow. Examples of off-nominal events that required detection and action by pilots and/or controllers are provided in Table 1.1 below.

Human performance modeling of these off-nominal scenarios, with appropriate and valid input parameters, can lead to a detailed understanding of operator performance, provide insight into the root causes of human error, and determine conditions of latent error, which, if left unchecked in system design conditions, may lead to errors. Testing such advanced system concepts in the relative safety of a Human Performance Model (HPM) is both cost- and time-efficient and, when used in concert with empirical research, is a system design concept that is likely to achieve maximum human performance (see Gore & Jarvis, 2005; Foyle & Hooey, 2008). Such an approach during the design, or re-design, of a system will produce systems that are safer, more efficiently used by the operator, more robust to errors and inadvertent misuse, and more likely to bridge the gap when moving from an existing system to a future operational system. The manner in which pilots and controllers detect and respond to these events is therefore of the utmost importance to the success of the ASDO concept, and is the focus of this research. The goals of this research are to characterize human-system interactions for future technologies needed to enable the NextGen, and to identify candidate scenarios and related data parameters required to develop HPMs. These models can be used to predict human-system performance associated with the new roles, procedures, and technologies characteristic of NextGen SDO.

¹ Formerly known as NGATS, currently referred to as NextGen

Table 1.1. Potential Off-Nominal Events in the ASDO Transitional Airspace

| Off-Nominal Continuum | Off-Nominal Event | Impact on ASDO Operations |
|---|--|--|
| Less Likely (Just outside normal operations)  Very Rare Events | Conflict Alert | Given increased precision requirements and reduced separation minima, the frequency of both conflict alerts and false alerts may increase dramatically in future ASDO environments impacting pilot and controller workload and trust in automation. |
| | Unpredicted Weather Events | Emergent weather conditions in the terminal airspace can cause severe propagating safety effects in ASDO environments. |
| | Sudden Turbulence or Wind-Shear | These events may require an adjustment to an aircraft's trajectory increasing workload for both pilots and controllers. In some cases, aircraft may have to exit ASDO operations eliminating the ability to conduct 4D trajectories or very-closely spaced runway approaches. |
| | Aircraft Deviates from Assigned Trajectory | Since aircraft in ASDO will be operating in closer proximity than in current-day operations, any deviation from the assigned trajectory is much more likely to cause an immediate conflict with another aircraft, and safe avoidance maneuvers may be limited or unavailable. |
| | Security Breach | Any airport that suffers a security breach will cause massive disruptions for both pilots and ATC (Air Traffic Control) who may have to revert to manual operations to safely divert aircraft. |
| | Equipment Failure | The NextGen is based on multiple layers of technology and implies increased flight deck automation and new function allocation. Any number of equipment failures could occur such as a failure of GPS or ADS-B, aircraft-based surveillance systems, flight automation, or datalink. |

The present work followed a three-phase approach to characterize pilot performance in off-nominal scenarios relevant to ASDO operations. The interaction among the three phases of the research is illustrated in the figure below (Figure 1.1). In Phase 1, detailed task analyses for current-day approaches and departures were generated, and nominal and off-nominal scenarios for NextGen operations were projected. These scenarios were used to guide Phase 2 and 3 research efforts. Phase 2 of the research used a combined top-down, bottom-up approach to: (1) Conduct a parameter meta-analysis of the available off-nominal data for arrival / approach and departure phases of flight; and (2) Document human performance parameters such as response latency and accuracy allowing for generalization to future ASDO operations. These parameters were used to refine a model of human attention in Phase 3, the Noticing-time Salience, Effort, Expectancy, and Value (N-SEEV) model (Wickens, Goh, Helleberg, Horrey, & Talleur, 2003; Wickens & McCarley, 2008; Wickens, McCarley, Alexander, Thomas, Ambinder, & Zheng, 2008; Wickens Sebok, Bagnall, & Kamienski, 2007). The model was then run in a variety of conditions to perform sensitivity analyses to demonstrate the effect of event eccentricity and salience on miss rate and noticing time. The model

runs provided data on distribution of attention on the flight deck, event detection latency, as well as duration of attentional neglect, and illustrated that the model was a good fit to the empirical data outlined in Phase 2. Finally, the model was used to predict pilot performance to off-nominal events in NextGen Scenarios.

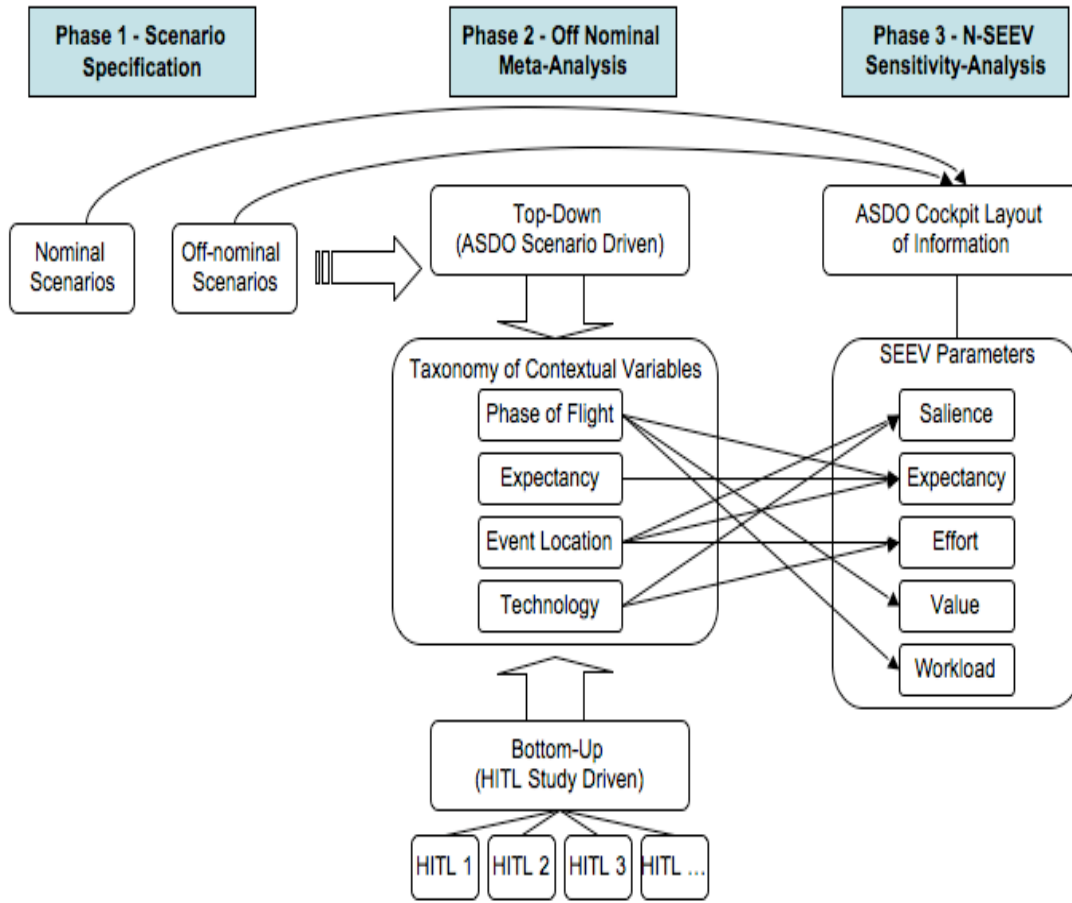

Figure 1.1. Interactions among Phases 1) Scenario Specification, 2) Off-nomina Meta-Analysis, and 3) N-SEEV Sensitivity Analysis.

CHAPTER 2. PHASE 1: ASDO CONCEPT DEVELOPMENT AND SCENARIO SPECIFICATION

2.1 Introduction

To meet the expected increases in air traffic demands, the National Aeronautics and Space Administration (NASA) and the Federal Aviation Administration (FAA) are developing and researching Next Generation Air Transportation System² (NextGen) concepts. The NextGen Airspace Super Density Operations (ASDO) concept provides high efficiency by relying on trajectory-based operations. These are intended to be robust to weather and other disturbances, and allow pilots and air traffic managers to meet increased capacity demands while minimizing environmental impact (Isaacson, 2007). With the expectation that NextGen will provide a closer coupling between the airport and airspace domains, there is a need to identify the shared impact of the proposed operational concepts at the boundary between these domains, so that the flight crew experiences a seamless transition.

Under current-day nominal conditions, this transition phase represents a period of higher risk exposure, complexity, and operator workload compared to some other phases of flight. It is likely that ASDO may exacerbate these issues by changing the nature of the flight deck-to-ground (i.e., pilot-to-controller) interactions. Changes may involve allocating additional responsibilities to the flight deck in order to reduce physical separation between aircraft and other potential hazards at times when uncertainty in critical airspace parameters (e.g., weather) is increased. Changes for ASDO will certainly involve allocating greater responsibility to both ground-based and air-based automation tools. ASDO adds to pilot task demands the need to receive and comply to 4D trajectories, while coupled with another aircraft for a very closely spaced runway landing, which implies the need to monitor displays for wake vortex information. Adding to the workload is the additional requirement of receiving and acknowledging a taxi clearance while airborne to ensure smooth taxi operations.

Often procedures are designed to support routine activity, but they cannot always anticipate every off-nominal situation. Generally, reliability levels are specified for equipment, in order to meet certification requirements. However, experience has revealed that even certified equipment can fail (or fail to operate as intended), and, in particular, the necessary human (pilot and controller) element in the NextGen system will also occasionally contribute unpredicted or unwanted actions. Thus, it is necessary for computational models to assure that the system is robust and resilient to these unexpected or off-nominal events. Even though humans may be responsible for causing such events (e.g., due to an error or erroneous assumption about how automated tools will function in a specific situation), so too they will need to **respond to** such events. Correspondingly then, computational models of human performance must be populated with valid parameters of these off nominal response times and accuracies.

² Formerly known as NGATS, currently referred to as NextGen.

Thus, human performance modeling of these off-nominal scenarios with appropriate and valid input parameters can lead to a detailed understanding of operator performance, provide insight into the root causes of human error, and determine conditions of latent error, which, if left unchecked in system design conditions, may lead to errors.

This approach will also allow designers to identify concepts that may be unsafe and should be discarded, because predicted responses to unusual, but still possible, off-nominal events are simply too slow or error-prone to preserve safety.

This first phase of the current project aims to identify prototypical NextGen scenarios with the goal of creating valid human performance models. The focus of this effort has been on long-term (e.g., 2025) NextGen implementation. Models will be used to evaluate performance in potential NextGen conditions, and to identify potential concerns.

The specific objectives of Phase I of this research, which is the focus of the current chapter, *The ASDO Concept Development and Scenario Specification*, are to:

1. Define detailed nominal scenarios for arrival / approach and departure.
2. Develop high-level nominal NextGen scenarios for arrival / approach and departure.
3. Identify and characterize specific off-nominal NextGen situations for arrival / approach and departure.

This chapter summarizes the project team's efforts in identifying and characterizing NextGen nominal and off-nominal occurrences. Section 2.2 describes the methods the team used to accomplish these goals. Section 2.3 describes current-day pilot operations, including the phases of flight, a modern glass-cockpit flight deck, and the flight crew responsibilities. Section 2.4 provides a narrative of the current-day nominal arrival / approach and departure scenarios. Section 2.5 gives an overview of NextGen pilot operations and identifies the assumptions the project team made in their analyses. Sections 2.6 and 2.7 contain the descriptions and results of detailed analyses of NextGen arrival / approach and departure scenarios. For each scenario type, the nominal and off-nominal events are identified and described. Detailed information is provided for the off-nominal events. These include tables of contributing factors, modified Murphy Diagrams, and results of a focus group discussion. Section 2.8 concludes with a summary and a brief description of how these results will be used in the subsequent phases of this research.

2.2 Methods

The work consisted of four main tasks: Analyzing current-day nominal operations, developing a high-level vision of NextGen operations, specifying equivalent nominal scenarios in NextGen airspace, and identifying potential off-nominal occurrences in the NextGen scenarios. In performing this work, the project team reviewed relevant literature (See Appendix A for a list of relevant documents), interviewed pilot and air traffic control (ATC) subject matter experts (SMEs), conducted a focus-group data-gathering session with six commercial pilots, and met with NextGen concept developers and researchers from NASA and industry. The team took an iterative approach to the tasks, developing a preliminary understanding and building onto it with further data collection and analyses.

The first step in this work was to perform *detailed task analyses of current day nominal arrival / approach and departure scenarios* from the flight deck perspective. Arrival / approach scenarios were evaluated from the Top of Descent (TOD) to just after touchdown and rollout to the taxiway. Departures were from just before takeoff (at the end of the runway) to Top of Climb (TOC).

The current-day task analyses are presented in Appendix B (arrival / approach and landing) and Appendix C (departure, climb, and initial level-off). These analyses detail the tasks performed by the captain and first officer of a Boeing 777 (B-777) in current day operations. They also identify the displays and controls used by the flight crew to gather information or perform actions. In addition, the analyses include time estimates for each task.

The task analyses were accomplished in a series of meetings with the pilot SME, using appropriate B-777 procedures, and discussing step by step how tasks are performed. The team had access to the B-777 flight manuals and the navigation, arrival, approach, and departure charts needed for the chosen scenario. Sitting before a life-size poster of a B-777 flight deck, the pilot SME pointed out relevant controls and displays for each task. Scenarios were created by selecting a current route and iterating the arrival and departure scenarios until all relevant details were included.

In particular, the project team sought scenarios where NextGen technology benefits would apply, and where off-nominal issues could be explored via human performance modeling in subsequent efforts. In order to explore off-nominal issues, the nominal scenarios needed sufficient details for eventual comparisons with the off-nominal situations. The main purpose was to enable these comparisons, so the team began with SME discussions, examined current B-777 controls and displays, and created the detailed task analyses for arrival and departure, as shown in Appendices B and C.

Second, an effort was undertaken to develop an *understanding of the NextGen concepts* that will affect future airspace and airport operations. This was accomplished by identifying and reviewing numerous NextGen and ASDO documents (the References section has a complete list). Further, the team discussed these concepts with a pilot SME who is a United B-777 captain and a regular consultant to NASA. The SME has both operational experience with various NextGen concepts (e.g., tailored arrivals, equivalent visual operations) and familiarity with NextGen research (e.g., merging and spacing displays, synthetic vision displays). In addition, the team included Dr. Christopher Wickens, who has many years of experience researching NextGen concepts and enabling technologies (e.g., the synthetic vision system, wake vortex visualization techniques, cockpit display of traffic information).

Once the team developed a preliminary understanding of NextGen, a presentation outlining this vision was created. Three team members met with several concept developers at NASA Ames to discuss these issues in detail. Further, the team met with a retired air traffic controller, who was familiar with ATC automation concepts, to discuss NextGen concepts and operations from the ground perspective. The team used the comments from NASA personnel and the air traffic controller to refine the NextGen vision, described in detail in Section 2.5.

Next, the team *identified preliminary NextGen scenarios*. These were created for both *arrivals and departures*, and identified both *nominal and off nominal conditions*. The team identified relevant

NextGen concepts and enabling technologies from various NASA and Joint Planning and Development Office (JPDO) NextGen documents, and developed timelines of potential NextGen scenarios. These were distributed and discussed among the team. The timelines were updated, discussed in detail with the pilot and ATC SMEs, and further refined.

Off-nominal scenarios were evaluated in more detail. This was done via discussions with the SME, project team brainstorming, and review of the small, but growing literature on off-nominal events caused by future airspace technology, to identify the causal factors that could lead to each identified off-nominal situation. A systematic approach to identify off-nominal events, and their contributing factors, was modified from the approach proposed by Foyle and Hooey (2003). Foyle and Hooey proposed that off-nominal events could be classified as a function of human-system interaction issues. The human-system interaction issues deemed relevant for NextGen operations include:

- i) *Environment* – Unexpected changes in the environment such as sudden turbulence or windshear.
- ii) *Management*– Interactions with other agents in the system such as other pilots, ATC, company dispatch,
- iii) *Human* – Events caused by pilot error, and
- iv) *Machine* – Failure (partial or total) of the physical equipment or automation.

There are two caveats that merit discussion. First, this research is primarily pilot-centric. That is, the off-nominals, and contributing factors, were developed from the perspective of ‘what could go wrong’ on the flight deck. Second, the scope of this research effort limited the off-nominal definition to NextGen ASDO operations. Off-nominal events that occur in current-day operations such as Flight Management System (FMS) mode-awareness errors, or an aircraft emergency were not included.

The project team ***presented the preliminary NextGen scenarios to NASA concept developers*** to solicit feedback about the NextGen scenario development work, and to identify potential missing events.

To evaluate the off-nominal situations in more detail and to identify other potential off-nominals, the team conducted a ***scenario-based focus group***. This group consisted of six (five current and one recently retired) airline pilots. The focus group moderators presented the envisioned NextGen operations (See Appendix D for presentation materials), starting first with arrival / approaches and then departures. The focus group moderators guided a discussion to determine how the proposed NextGen operations would change pilots’ tasks and procedures. Subsequently, the participants were asked to brainstorm to identify off-nominal events specific to NextGen operations. Walking through time-slices of the nominal NextGen arrival / approach and departures, participants were asked to identify “What could go wrong.” After an unstructured brainstorming session, the moderators guided the pilots to consider the four human-system categories: 1) Environment (e.g., weather disruptions, traffic) 2) Management (e.g., ATC errors or interactions with other aircraft), 3) Human (e.g., human error) and 4) Machine (e.g., system unreliabilities or system failures).

Upon completion of the off-nominal brainstorming session, the moderators presented a list of all off-nominal events (those identified previously by the project team and those identified during the focus group) to the pilots. Pilots rated these off-nominal events on a scale of 1-7 in terms of their perceived impact of safety and their perceived impact on efficiency using the ratings scales below.

Severity of impact on safety

| | | | | | | |
|--|---|---|----------|---|---|--|
| 1 | 2 | 3 | 4 | 5 | 6 | 7 |
| Very low <i>(No anticipated safety threats)</i> | | | Moderate | | | Very high <i>(Loss of separation or aircraft state jeopardized)</i> |

Severity of impact on system efficiency

| | | | | | | |
|--|---|---|----------|---|---|---|
| 1 | 2 | 3 | 4 | 5 | 6 | 7 |
| Very low <i>(Other aircraft not affected)</i> | | | Moderate | | | Very high <i>(All aircraft in region require re-routing)</i> |

The demographic data summary for the focus group participants is provided in Appendix E, and the results of the off-nominal discussion and ratings are summarized in Sections 2.6 and 2.7.

Next, following the systematic approach to identify off-nominal events and their contributing factors, **Murphy Diagrams** were created to present contributing factors associated with the Environment, Management, Human, and Machine. Murphy diagrams, developed by Pew, Miller, and Fehrer (1981) are based on the axiom of Murphy’s Law, which states that ‘if anything can go wrong, it will’. Murphy diagrams are used to identify all individual sources of error that could occur. A Murphy diagram is a tree diagram in which the first branch is a dichotomy between successful and unsuccessful performance. Unsuccessful performance is then redefined in terms of the sources of error. In this case, the sources of error include the taxonomy adapted from Foyle and Hooey (environment, management, human, and machine). Note that these are considered *modified* Murphy Diagrams, since traditional Murphy diagrams identified proximal and distal contributors to incidents instead of our imposed taxonomy of off-nominal contributors (Kirwan & Ainsworth, 1992).

While the focus of this work is pilot-centric, it was deemed important to consider the ATC perspective as well, given the close interactions between pilots and ATC. To get an **Air Traffic Controller’s perspective**, the team interviewed a retired air traffic controller with 25 years of tower and Terminal Radar Approach Control (TRACON) experience. His insights allowed the team to further refine both NextGen concepts and contributors to detailed off-nominal situations. A summary of the discussion with this ATC SME is in Appendix F.

2.3 Description of Current-Day System

Although this research was conducted using the B-777 as an example, the information presented here and in Section 2.4.1 applies to all air transports. Air carriers (i.e., airlines and cargo carriers) are required to file instrument flight rule (IFR) flight plans. Aircraft on IFR flight plans are required to follow ATC directives. In return, ATC keeps aircraft safely separated, both in the air and on the ground. As previously mentioned, this research focused on the arrival, approach and landing phases of flight, and then a departure (take-off, climb). Figure 2.1 shows the relationship of these phases to the other phases of *normal* flight; the highlighted segments were the focus of this research.

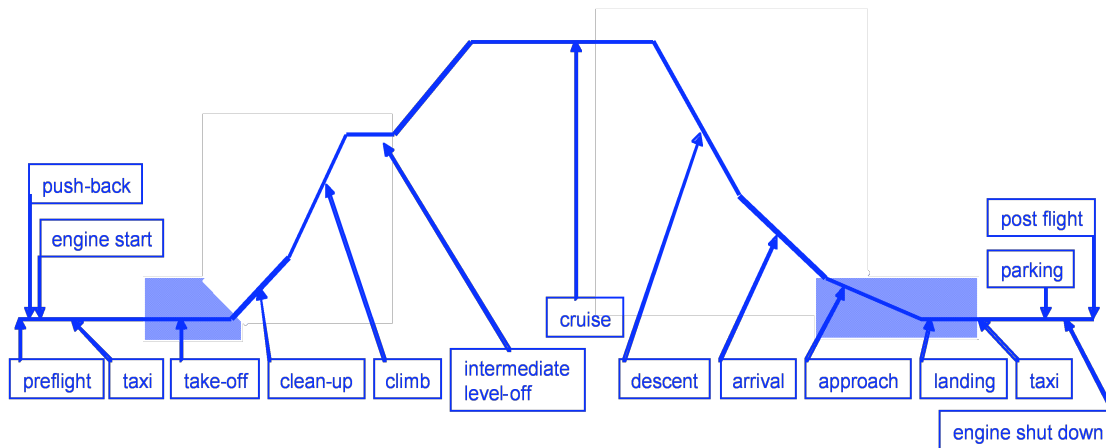

Figure 2.1. Normal Phases of Flight

Although the missed approach and subsequent divert phases of flight are not shown in Figure 2.1, they are considered phases of a normal flight, but their occurrence is rare amongst professional pilots. Two of the SMEs estimated the occurrence of missed approaches to be about one missed approach per 5 years per pilot, or, based on 20 landings per month per pilot, 1 missed approach per 1200 landings. Similarly, the hold phase of flight, which can be requested by ATC during the cruise, descent, or approach phases of flight, has become less common in recent years due to a more strategic methodology for spacing and sequencing arriving aircraft. Even though uncommon, missed approaches and holds are still considered part of normal flight. This is in contrast to emergency situations, which are abnormal and outside the scope of this research for current day operations.

2.3.1 Arrival, Approach, Landing, and Departure Phases of Flight

The arrival phase may begin at about 75 to 100 miles from busy airports as procedures for the orderly sequencing and descent begin to take effect. The goal is to bring aircraft from the high altitude cruise environment to a position and altitude nearer the airport where they can begin a published approach. The approach phase typically begins at about 30 miles from the arrival airport, at about 10,000 feet, and ends just prior to the main gear touching down. The landing phase then begins, and continues until the pilot has taxied off the runway. During the arrival and approach

phases, pilots of air transports must follow instrument approach procedures near busy metroplexes, regardless of visibility, because published instrument procedures ensure an orderly flow of traffic into congested airports. Instrument arrival and approach procedures have been meticulously designed to transition aircraft safely from the enroute airway structure to the arrival airport by specifying the course and altitude to avoid terrain, obstacles, and nearby air traffic patterns.

Instrument approaches are classified into two types: non-precision and precision. The difference is determined by the type of navigation aids available at the airport as well as the corresponding instrumentation available on the flight deck. The B-777 is equipped with a full range of instrumentation to support virtually all types of non-precision and precision approaches. A non-precision approach provides only lateral guidance to the pilot whereas a precision approach provides both lateral and vertical guidance to the runway. Instrument Landing System (ILS) precision approaches for properly equipped runways and flight decks are further delineated into three categories (Category I, II, III) depending on minimum visibility requirements and decision height altitudes. For this project, the focus was on a Category I ILS approach.

Assuming visibility permits the Category I approach to continue, the landing phase of flight goes relatively quickly. After passing through decision height, the pilot uses visual cues to align with the runway centerline. The landing of the aircraft is very much a skill-based task, as the pilot flies the aircraft to touchdown and roll-out using the aircraft's flight controls and throttles. For more details about approach types and procedures, see the *Cognitive task analysis of commercial jet aircraft pilots during instrument approaches for baseline and synthetic vision displays* (Keller, Leiden, & Small, 2003).

Lastly, for the present research, the departure phase that we examined included the takeoff, initial climb and aircraft clean-up (landing gear and flaps raised), and then a climb to an intermediate level-off at about 23,000 feet (FL230). The final climb to the enroute cruise altitude is very similar to the intermediate climb, so we stopped our analysis at the intermediate altitude. For departures from busy airports, there are often published standard instrument departure (SID) procedures that pilots follow to safely exit congested airspace. Equally likely is that ATC will issue direction vectors and step climbs to keep traffic separated and to enable the departing airliner to exit the airport's airspace and join the enroute cruise phase as expeditiously as practical.

2.3.2 Flight Deck Controls, Instrumentation, and Displays

The B-777 flight deck (Figure 2.2, accessed from <http://www.airliners.net/>) is referred to as a “glass cockpit” because computer screens are used to represent the traditional instrumentation (e.g., attitude indicator) found in older aircraft. In addition, a glass cockpit allows the information from several different traditional instruments to be combined onto a single display, saving panel space and allowing the pilots to gather the most salient related information in a single visual scan. Only the most relevant B-777 information is presented below with emphases on depicting the primary controls, instrumentation, and displays needed during the arrival, approach, landing, and departure phases of flight. Figure 2.3 (following page) depicts the B-777's forward instrument panel (see www.meroweather.com for interactive images of all instruments and displays on the B-777 flight deck).



Figure 2.2. A B-777 Flight Deck

The primary flight deck controls and displays that will be described in following subsections are:

- Flight Management System (FMS),
- Mode Control Panel (MCP),
- Primary Flight Display (PFD),
- Navigation Display (ND),
- Electronic Flight Instrument System (EFIS),
- Display Selection Panel, and
- Pedestal controls.

2.3.2.1 Flight Management System

The function of the flight management computer (FMC) is to assist the pilot with the planning and execution of the flight route. During the flight-planning phase of flight (prior to leaving the departure airport's gate), the pilot enters the flight route, aircraft weight, and expected wind and temperature conditions into the FMC via the control display unit (CDU) interface (Casner, 2001). Collectively, the FMC and CDU are referred to as the *flight management system (FMS)*.

777 Forward Instrument Panel

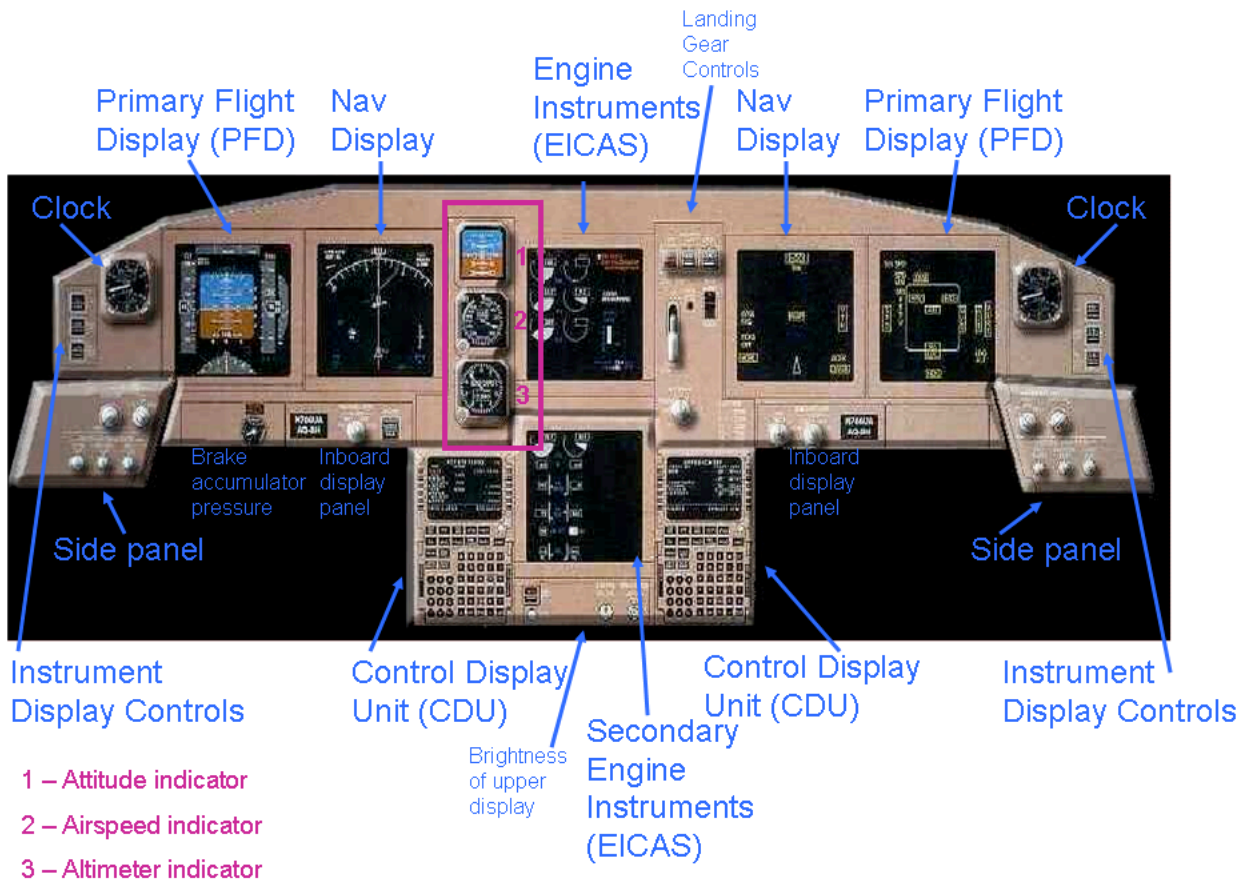

Figure 2.3. A B-777 Forward Instrument Panel

Information about the flight route includes *expected* departure runway and departure procedure, cruise altitude and waypoints, arrival and approach procedures, and the landing runway assignment. The *actual* flight route may differ from the expected or planned route depending on weather and ATC requirements, often requiring the pilot to reprogram the FMC in flight. The FMC is capable of calculating the optimal flight path and economical speeds during the climb, cruise, and descent phases of flight. When an aircraft is following the flight route in the FMC, it is often simply referred to as the *FMS trajectory*.

Although the FMS trajectory theoretically can be followed from just after takeoff through landing, the reality is that ATC clearances during the arrival and departure phases of flight often differ from what has been programmed into the FMC due to traffic sequencing. Pilots do not typically reprogram the FMC to account for these ATC clearances for two reasons. First, reprogramming requires long task times, cognitive workload, and heads-down time (Degani, Mitchell, & Chappel, 1995). Second, ATC clearances at low altitudes (below about 18,000 feet in the U.S.) are more tactical, instructing the aircraft to change heading, altitude, or airspeed (or any combination of the three). Hence, the strategic guidance functions (e.g., VNAV (for vertical navigation)) that are needed to follow an FMS trajectory during other phases may be impractical at low altitudes.

Instead, simpler and quicker guidance functions that correspond directly with ATC clearances for heading, altitude, and speed are used via the Mode Control Panel (MCP), as explained below.

2.3.2.2 Mode Control Panel

The B-777 MCP, shown in Figure 2.4, is used to select the guidance function to change the trajectory as needed. The MCP allows guidance functions to be either *engaged* or *armed*. A guidance function that is *engaged* means that the guidance function is currently active. A guidance function that is *armed* means that the guidance function will engage (i.e., become active) when the required conditions for its engagement have been met. Because the guidance functions that are engaged or armed on the MCP can be difficult to decipher based on a quick glance at the MCP, a portion of a separate display, the primary flight display (PFD; described later), displays the speed, lateral, and vertical path guidance that is engaged or armed. The portion of the PFD for this status information is the *flight mode annunciation* (FMA), also described later in the PFD subsection.

777 Glareshield – Mode Control Panel (MCP)

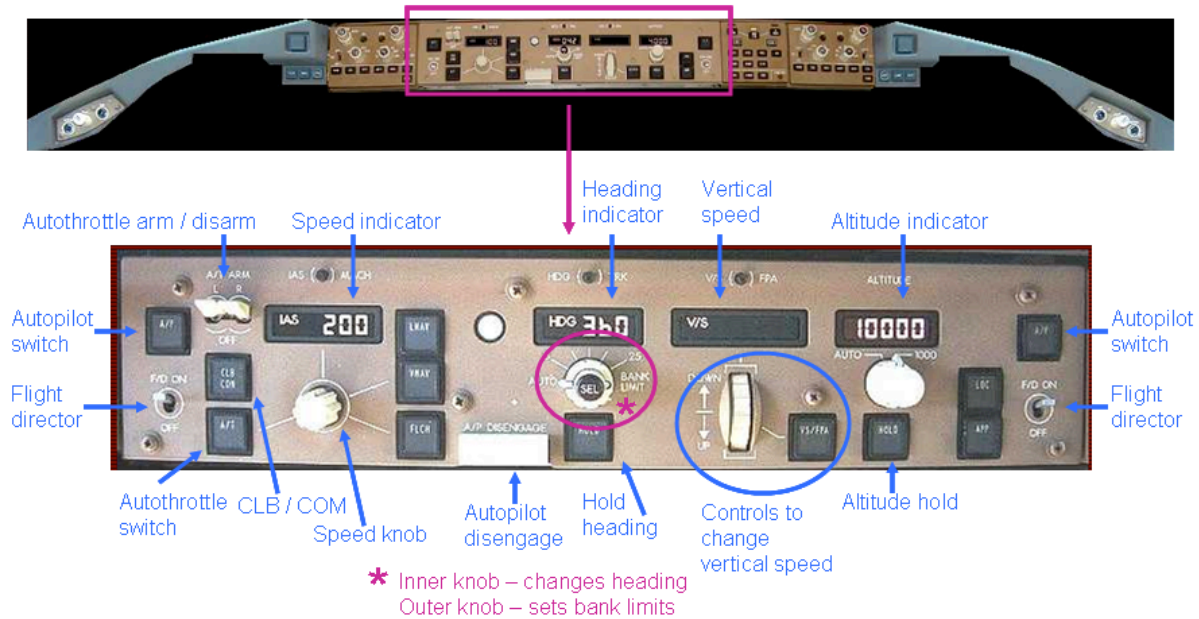

Figure 2.4. A B-777 Mode Control Panel

MCP switches and indicators

A brief description of the MCP functions used during approach is as follows (adapted from Casner, 2001).

- A/P – autopilot activation and engagement (this control is available to both the captain (CAP) (left side) and the first officer (F/O) (right side).
- F/D – flight director for captain (left side) and first officer (F/O) (right side).
 - ON – Allows display of Flight Director command bars on respective PFD.
 - OFF – Removes Flight Director from respective PFD.
- A/T ARM
 - ARM – Arms auto-throttle for engagement.
 - OFF – Disarms auto-throttle, preventing engagement.
- CLB/CON – Used to reduce throttle setting to climb (CLB) thrust after takeoff and climb to 400 feet above the runway. If single engine, then this switch commands maximum continuous (CON) thrust.
- IAS/MACH – Speed indicator.
 - Speed Knob – Changes the value in the speed indicator.
- LNAV – Engages FMS lateral navigation guidance.
- VNAV – Engages FMS vertical navigation guidance.
- FL CH – Engages FLIGHT LEVEL CHANGE function.
- Disengage Bar – Press the bar to disengage the autopilot from controlling aircraft.
- HDG – Magnetic heading selection and indication.
 - SEL Knobs – Inner knob – Changes value in heading indicator.
 - Outer knob – Bank limit selector.
- Heading HOLD – engages HEADING HOLD.
- V/S – Vertical speed selection (in feet per minute) and selector (thumb wheel).
- Altitude selection and selector.
 - Altitude Knob – Changes the value in the altitude selection window.
- Altitude HOLD – Engages ALTITUDE HOLD mode manually.
- LOC – Arms or engages LOCALIZER mode to intercept and track the localizer (lateral guidance signal) to the runway.
- APP – Arms or engages APPROACH mode to intercept and track both localizer and glideslope signals to the runway.

2.3.2.3 Primary Flight Display

During the approach, the PFD is the primary display used for aircraft control; both the captain and F/O have a PFD (Figure 2.5).



Figure 2.5. A Primary Flight Display

The information provided by the PFD includes:

- Top center of display – FMAs for speed, lateral, and vertical modes (left to right).
- Left side vertical bar presents the airspeed and a trend arrow (green). The current airspeed is in the magnification “window” (currently 30 knots).
- Middle of display – the artificial horizon (i.e., attitude indicator) depicted by blue (sky) and brown (ground). The display is now showing zero bank (wings level) and zero pitch. Along the top of the blue portion is the bank indication. Along the bottom and right side are “dots” (represented by white circles) left or right of the localizer, and above or below the glideslope. The diamonds show actual position relative to the localizer and glideslope centerlines.
- Bottom center shows the aircraft heading in degrees (with the ones digit dropped).
- Right side (to the right of the attitude indicator) shows the altitude. The current altitude is in the magnification “window” (currently about 130 feet).
- Vertical speed indicator is to the right of the altitude bar. It is a pointer type indicator and presents thousands of feet per minute (fpm) of climb or descent (currently indicating about 750 fpm of descent).

2.3.2.4 Navigation Display

The navigation display (ND) provides a map view of the area in which the aircraft is flying (Figure 2.6). Both the captain and F/O have an ND. The ND can be configured in various modes with *map* mode being the most common. In fact, during approach, it is common for the ND of one of the pilots to be in map mode and the other pilot to be in *ILS* mode. ILS mode allows the raw ILS data to be displayed. Using different modes allows the pilots to crosscheck information. For example, the map mode displays information based on where the FMS calculates the aircraft position to be. If the aircraft location is in error for any reason (e.g., a navigation radio on the ground has been moved, but the onboard database has not been updated to reflect the new location), there would be no way to know this from the map mode. However, if the other pilot is using the ILS mode and there is an ILS signal detected, then the discrepancy would become apparent by comparing the two displays.



Figure 2.6. A Navigation Display

The information provided by the ND includes:

- Upper left corner – the ground speed (GS; currently 455 knots) and true airspeed (TAS; currently 485 knots). Directly beneath them is the wind vector (from 285 degrees at 33 knots), plus an arrow depicting the wind direction.
- Upper middle – the current magnetic track, 300 degrees.
- Upper right – the current waypoint (PP024), the expected time for reaching that point (0443.2 Zulu, or Greenwich Mean Time), and the current distance to that point (26.6 nautical miles).

- Middle - the four white arcs depict distances from ownship, which is the open white triangle near the bottom middle of the ND. In this example, each arc represents 40 nautical miles (nm) from ownship, with the second arc labeled as “80”. The outer arc also notes the heading or track, with the ones digit dropped, so that “30” means 300 degrees. The prominent green shading represents terrain or weather, depending on the ND modes selected. The currently programmed FMS trajectory extends from the front point of the ownship triangle. The lateral path is magenta, as is the next waypoint in the route; subsequent waypoints are white. Beneath each waypoint name is the expected time of arrival at that point. Near the ownship triangle are 2 diamonds, representing other aircraft detected by TCAS (the traffic collision avoidance system). To the right of ownship is an aircraft that is 3000 feet below ownship’s altitude. To the 10 o’clock position and about 60 miles from ownship, is another TCAS-detected aircraft that is only 900 feet below ownship (hence its larger symbol than the closer aircraft, mentioned above). The arrow next to the larger aircraft indicates that aircraft is descending.
- Lower left and right corners – illustrate the data blocks for the navigational radios (i.e., nav aids) tuned into the left and right aircraft navigation radios, respectively. In this case, both are tuned to JAB (a fictitious VOR) located 63.3 nm away. JAB is also on the route of flight as the 3rd waypoint from ownship’s current position. Its position is noted by a green VOR symbol (which obscures the white waypoint symbol) because it is the nav aid currently tuned into the navigational radio(s).

2.3.2.5 Electronic Flight Instrument System

The electronic flight instrument system (EFIS) is on either side of the MCP so that both pilots can access it to select from the various modes for their respective displays (PFD and ND). In addition to providing switches for altimeter modes, EFIS primarily allows the pilots to change the information presented on their respective NDs. For example, EFIS switches control the ND mode (which is usually the map mode), the scale of the display (in nautical miles), and which additional information is displayed (weather, waypoints, airports, terrain, etc.). Figure 2.7 further explains the EFIS functions.

777 Glareshield – EFIS

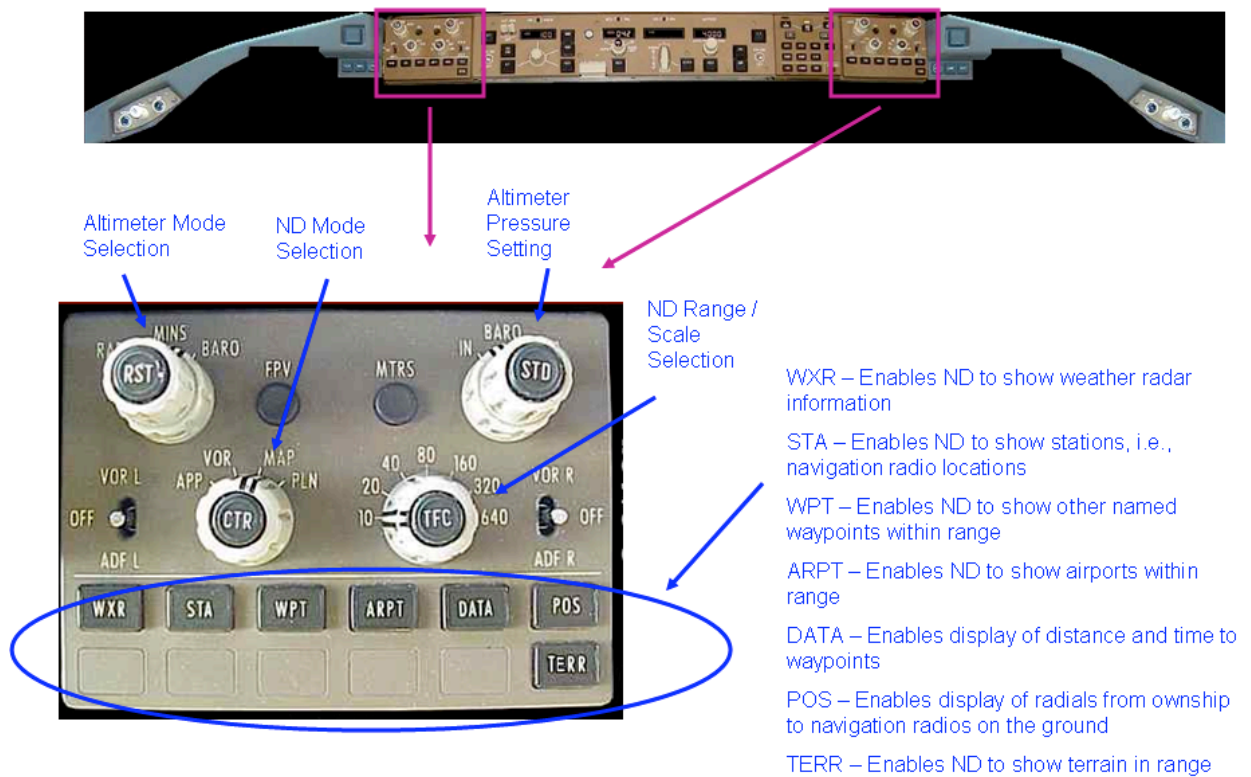

Figure 2.7. The Electronic Flight Instrument System

2.3.2.6 Display Select Panel

This single display select panel in front of the F/O controls which display formats are presented on the upper and lower EICAS (Engine Indicating and Crew Alert System), and the pilots' respective inboard displays. The F/O selects a display by pressing its button, and then what information to present on that display. In the example depicted in Figure 2.8, the lower center display currently presents engine and status information (which is the typical configuration). The F/O could also press the left inboard switch and then display the electrical system information there, although this would be unusual, as the lower center display is typically used for system schematics. If the lower center display failed, then the other displays would be used for supplemental information. The other function on this panel is the Cancel/Recall (CANC/RCL) button in the lower right corner of the panel. This button, on its first push, presents all alert messages (e.g., low hydraulic pressure) previously presented during the flight. The second push of this button removes (cancels) the list of alerts from the upper EICAS display.

777 Glareshield – Display Select Panel

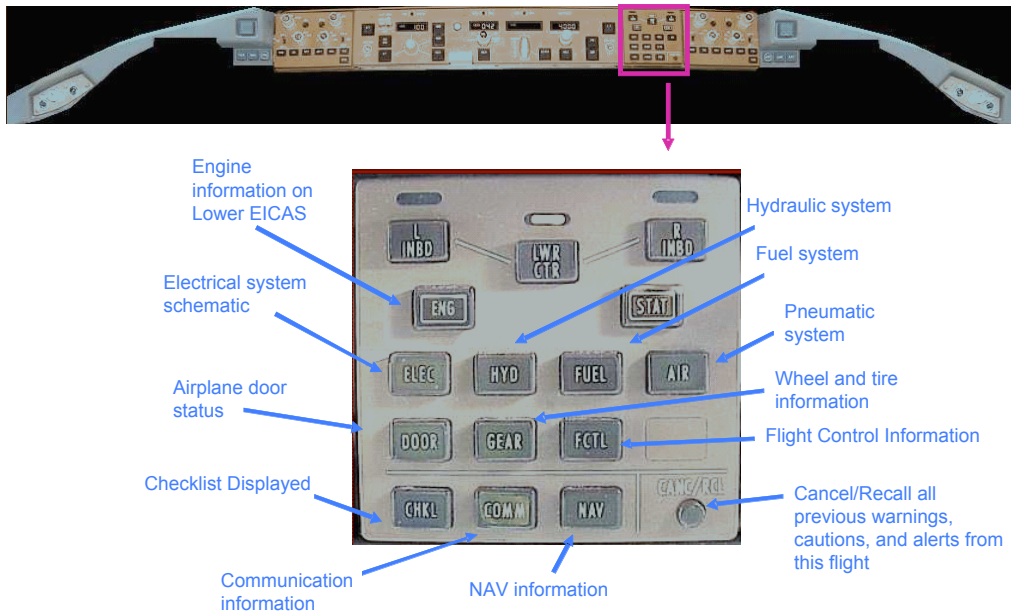

Figure 2.8. A Display Select Panel

2.3.2.7 Pedestal

The pedestal (Figure 2.9), located between the pilots' seats, has major controls, many of which are self-explanatory (for example, the throttles control engine thrust, the flap handle controls flap position, the radio panels control the respective radios), and a spare FMC CDU. Figure 2.9 shows other controls and displays; labels indicate the most relevant ones to the present discussion and to the task analyses in the appendices.

Less obvious are the left and right cursor control devices (CCD; upper left and right portions of Figure 2.9). The CCD is a touch sensitive pad and wrist-rest device with which either pilot can move a display cursor on the EICAS displays and click on items. It is most commonly used for checking-off electronic checklist steps on the lower EICAS.

777 Pedestal

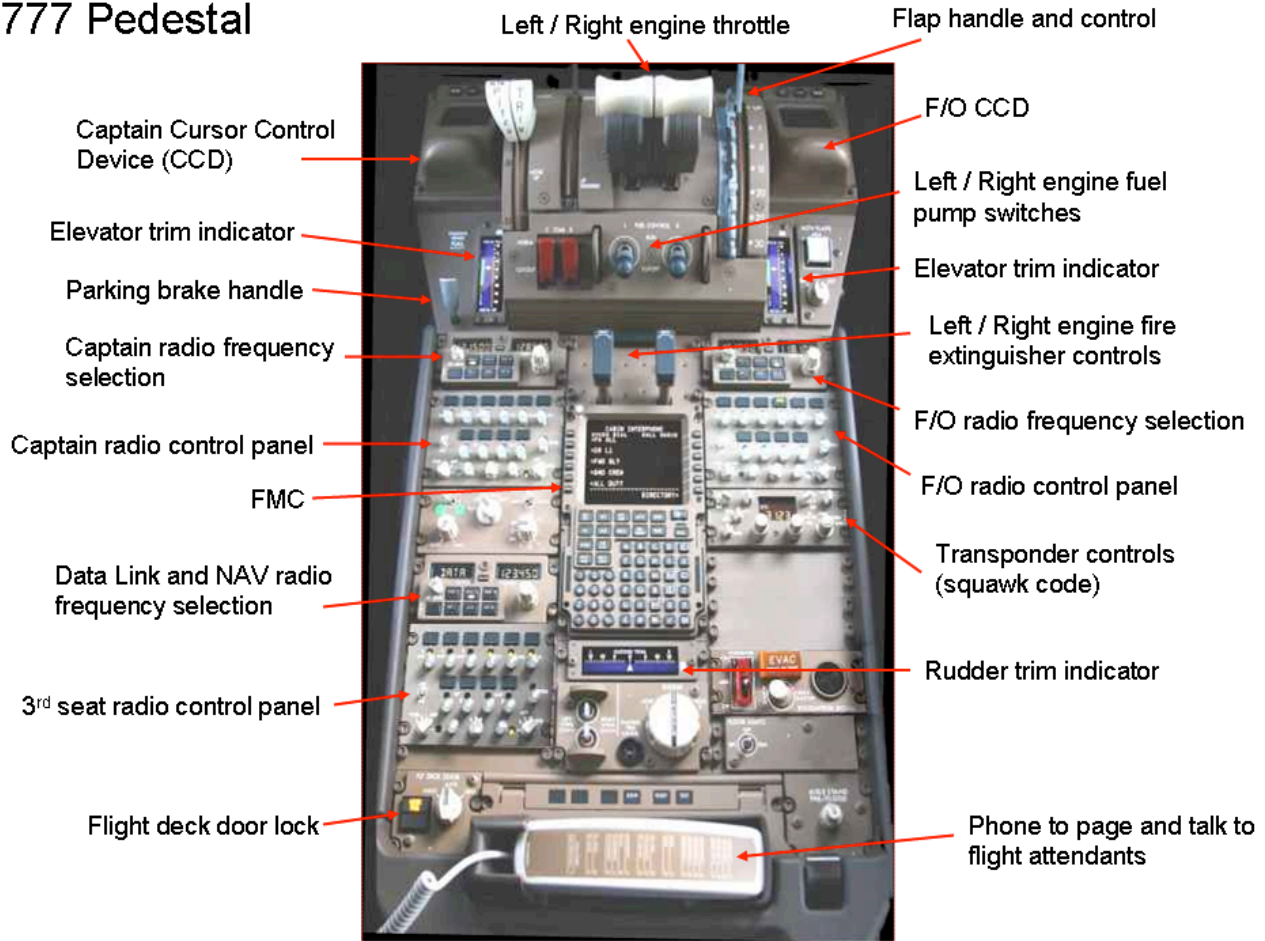

Figure 2.9. A B-777 Pedestal

2.3.3 Flight Crew

The B-777, like most modern airliners, has a two-pilot flight deck. The crew consists of a CAP and a FO, who sit in the port and starboard seats, respectively. The aircraft can be flown from either position. The person flying the aircraft is called the pilot flying (PF). The other person is the pilot not flying (PNF).

As the title suggests, the PF controls the aircraft by actually flying it with the yoke, rudder pedals and throttles, or via the autopilot controls described earlier in Section 2.3. The PNF monitors aircraft performance, communicates with ATC and the cabin (flight attendants and passengers), reads checklists, and configures the aircraft’s gear and flap positions upon the command of the PF. The PF and PNF work as a crew by coordinating all major trajectory or configuration changes. For example, when ATC clears the flight to a new altitude, the PNF acknowledges the radio call, the PF dials the new altitude into the MCP and points to the new MCP altitude setting, awaiting the PNF’s confirmation. After the PNF confirms the setting is correct, the PF controls the climb or descent to the new altitude.

Air carriers have different procedures that specify which pilot should be flying the aircraft during the various phases of flight. For example, one airline might specify that the CAP fly during take-off and the F/O fly during approach and landing. Then, on the next leg of the trip, they switch so the F/O flies the take-off. This allows both pilots to maintain their skill levels through all phases of flight. An exception to alternating PF and PNF duties is that the CAP taxis the aircraft at all air carriers with which we are familiar. Taxiing is not alternated between the F/O and CAP because most airliners have only one tiller (i.e., nose wheel steering control) located to the left of the captain's seat.

2.4 Current Day Nominal Scenarios

The following two sub-sections highlight a B-777 arrival and approach into San Francisco (SFO) from oceanic airspace, and then its departure from SFO's Runway 28L toward oceanic airspace. Both scenarios assume present-day (July, 2008) conditions in terms of available technology, and FAA and airline procedures. It is further assumed that the reader has at least a basic understanding of airline procedures and terminology (acronyms are defined in the Acronyms section). Lastly, in each sub-section, the CAP is the PF while the F/O is the PNF. The narratives are based on the detailed task analyses, which are provided in Appendix B (arrival) and Appendix C (departure).

2.4.1 Arrival / Approach

The arrival / approach scenario begins with the arrival of United 573, a B-777 from Honolulu, at 37,000 feet (i.e., FL370) over the Pacific Ocean heading toward SFO, about 175 miles from the coast of California. The flight crew is in radar and radio contact with Oakland Center and the oceanic strategic lateral offset procedure has been removed (which means that the aircraft is flying the centerline of the inbound course, not offset for wake turbulence avoidance on the oceanic "highways"). Cruise speed is Mach 0.84 in clean configuration; gross weight is about 450,000 pounds. The FMC is set for the arrival; waypoints go from CINNY to HADLY, OSI, MENLO, ROKME, HEMAN, OKDUE (final approach fix for SFO Runway 28L), RW28L (the waypoint designation for this runway), and OLYMM (the missed approach fix for the planned ILS approach to Runway 28L).

The flight deck door is locked after the pilots' meal trays and beverage containers were returned to the cabin. At this point in the flight, the pilots are mentally preparing for the arrival, approach, and landing by opening charts and gathering information – such as the current conditions at SFO (broadcast via the automated terminal information service, or ATIS) and the expected parking gate at SFO. In current-day operations, this information arrives via datalink. It is noteworthy that current weather at SFO is fair, with overcast skies and visibility limited to 5 nm, according to the ATIS. This information about instrument meteorological conditions (IMC) typically prompts the pilots to review procedures more carefully than they would when arriving in visual meteorological conditions (VMC).

Initial pilot actions are to verify that the FMC waypoints match the published arrival and approach charts, including speed and altitude restrictions. They also set-up the FMC for a VNAV ECON descent, followed by a Flaps 30 landing. Before the pace of required actions increases, the pilots

review the published arrival and approach information, and the PF verbally briefs the PNF about key items, procedures, and techniques. Both pilots set the altimeters, radio and navigation frequencies, decision height, and final course on their respective navigation displays.

In the verbal briefing, the pilots discuss normal procedures and what they expect the runway to look like when they break-out of the clouds in the last (approximately) 5 miles of the approach. They pay particular attention to contingencies, such as the missed approach procedure, in their structured conversation. Each pilot independently verifies procedural information and asks the other about specific techniques or items that may not be absolutely clear.

The “Approach Descent Checklist” requires specific checks and settings, and pilots typically also discuss items of personal preference. They configure the flight deck for landing as much as practical at this stage, including settings for autobrakes and display options. As they complete checklist items, the PNF clicks on items that have not automatically turned green (from white) on the electronic checklist display to confirm their accomplishment.

Typically, ATC radios flights to begin descent from the cruise altitude at the pilot’s discretion. The PNF acknowledges all such radio clearances, and both pilots coordinate new altitude settings on the glare shield’s MCP. UAL 573 starts down when the airplane reaches the “top of descent” point as determined by the FMC (based upon the weight, winds, and altitude restrictions on the arrival or approach). ATC issues new altitudes to UAL 573 to transition it from the enroute cruise environment to the airport environment as it flies the published route to the runway, and as traffic conditions dictate. At each altitude change, the pilots coordinate the new MCP setting so that there is no doubt that the autopilot will fly to the correct altitude.

Usually, early in the descent, the PNF will make an announcement to the passengers regarding the arrival airport’s weather, approximate landing time, and expected parking gate. As the aircraft descends, the PF pays particular attention to descent rates, published altitude or airspeed restrictions, current airspeed, engine performance and overall aircraft performance. The pilots also note autopilot mode annunciations on their primary flight displays (PFDs) to ensure everything is functioning normally.

While descending and flying closer to SFO, Oakland Center directs UAL 573 to switch to Northern California (NORCAL) approach control. This ATC facility clears UAL 573 for further descents, as traffic permits, and notifies the pilots to expect a specific approach to a specific runway at SFO. NORCAL also informs all aircraft on its radio frequency of any changes to the SFO altimeter setting, since altitudes below 18,000’ vary in absolute height based on the local atmospheric pressure (unlike higher altitudes which are based upon a fixed mean sea level). The local altimeter setting is the last step on the Approach Descent Checklist.

As UAL 573 continues to descend and maneuver for the approach to SFO, the pace of activity and traffic density increases. When visibility conditions permit, the pilots scan for traffic; if in the clouds, they monitor their cockpit displays more carefully. Approaching various clearance step-down altitudes, the PNF announces 1,000’ from the cleared altitude, and the PF acknowledges. Both pilots ensure the autopilot levels-off at the correct altitude.

Ideally, they would fly a continuous descent all the way to the runway, as a means to save fuel and to keep traffic moving smoothly. That is one goal of NextGen; current operations do not permit that efficiency. Therefore, as UAL flies closer to SFO (or any major airport), ATC often issues speed and altitude restrictions to sequence and space traffic for the most limited resource in the national airspace system – the runways. Using the cockpit display of traffic and the party line feature of the radio, the pilots form a mental picture of the traffic sequence and conditions. As examples, they can often determine which aircraft ahead of them is the one they will follow all the way to landing. They also get a sense of how congested traffic is by listening to ATC instructions to other aircraft to slow down and/or maneuver for spacing, or to enter holding patterns.

The PF sets the MCP and FMC for the next set of restrictions or clearances from ATC, both pilots verify the settings, and both monitor progress on their navigation displays. The PNF also announces to the cabin when the flight attendants should prepare for landing (at about 25-30 miles from the airport). As the pace of activity increases even more, the PF pays particular attention to aircraft performance and autopilot compliance to clearances. The PNF cross-checks and monitors, and is attentive to radio calls from ATC in order to answer them as expeditiously as practical.

As UAL 573 flies closer to SFO (about 15 miles), it is time to slow further and begin configuring the aircraft for landing. The PF calls for preliminary flap settings; the PNF sets the flaps and then confirms their position via the upper EICAS display. The PF also glances at the flap display, and can feel the aircraft pitch and thrust change as the flaps lower. At about 10 miles from the airport (and within 5 minutes of landing), the PF progressively slows toward a landing speed of about 130 knots by setting the desired speed on the MCP after calling for the next lower flap setting.

At about 5-10 miles from the runway threshold, UAL 573 intercepts and flies the ILS guidance. The PF will do so sooner, if cleared for the approach by ATC. Both pilots ensure that the ILS signal is strong and providing proper final approach guidance to the runway. Continuing to slow, the PF commands more flaps and “gear down” at the appropriate points. The PNF acts on the commands, confirms the commanded configuration, and announces them to the PF. At about this distance, the SFO tower typically clears UAL 573 to land on Runway 28L. The PNF acknowledges the radio call and repeats the clearance to the PF. Also, the PNF accomplishes the Final Descent Checklist and confirms the steps to the PF, who also double-checks them via quick glances. The PF’s primary concern is the precise performance of the autopilot as UAL 573 flies the ILS guidance at the correct speed, and in the correct configuration.

As UAL 573 flies closer to the Runway 28L, the PNF calls out mandatory altitude “gates” at 2,500’, 1,000’ and 500’. These points are when both pilots confirm aircraft performance, stability and configuration. The PNF also glances out the front window to try to see the airport or runway as UAL approaches 28L. As soon as the PNF sees the airport or runway environment, he or she announces that fact to the PF, who then brings the out-the-window view into his or her visual crosscheck. If the runway is not seen in time (typically by about 100’ above the runway), the PF executes a missed approach.

For this particular scenario, the pilots see the runway well before decision height. The PF disengages the autopilot and hand flies the B-777 to touchdown at about 1,000’ after the runway threshold on the runway centerline (the desired point). The speed brakes automatically rise as the

PF flies the nose wheel to the runway and begins to apply reverse thrust. The PF slows the aircraft on the centerline, and the PNF monitors the decreasing airspeed and the aircraft alignment. At 60 knots, the PF has reverted from reverse thrust to forward idle and uses the nose wheel steering to exit the runway. The PNF replies to the tower’s taxi instructions, monitors for taxiing traffic, and begins to cleanup the aircraft (e.g., raise the flaps) in preparation for the next outbound flight. This current day nominal arrival and approach is illustrated in Figure 2.10.

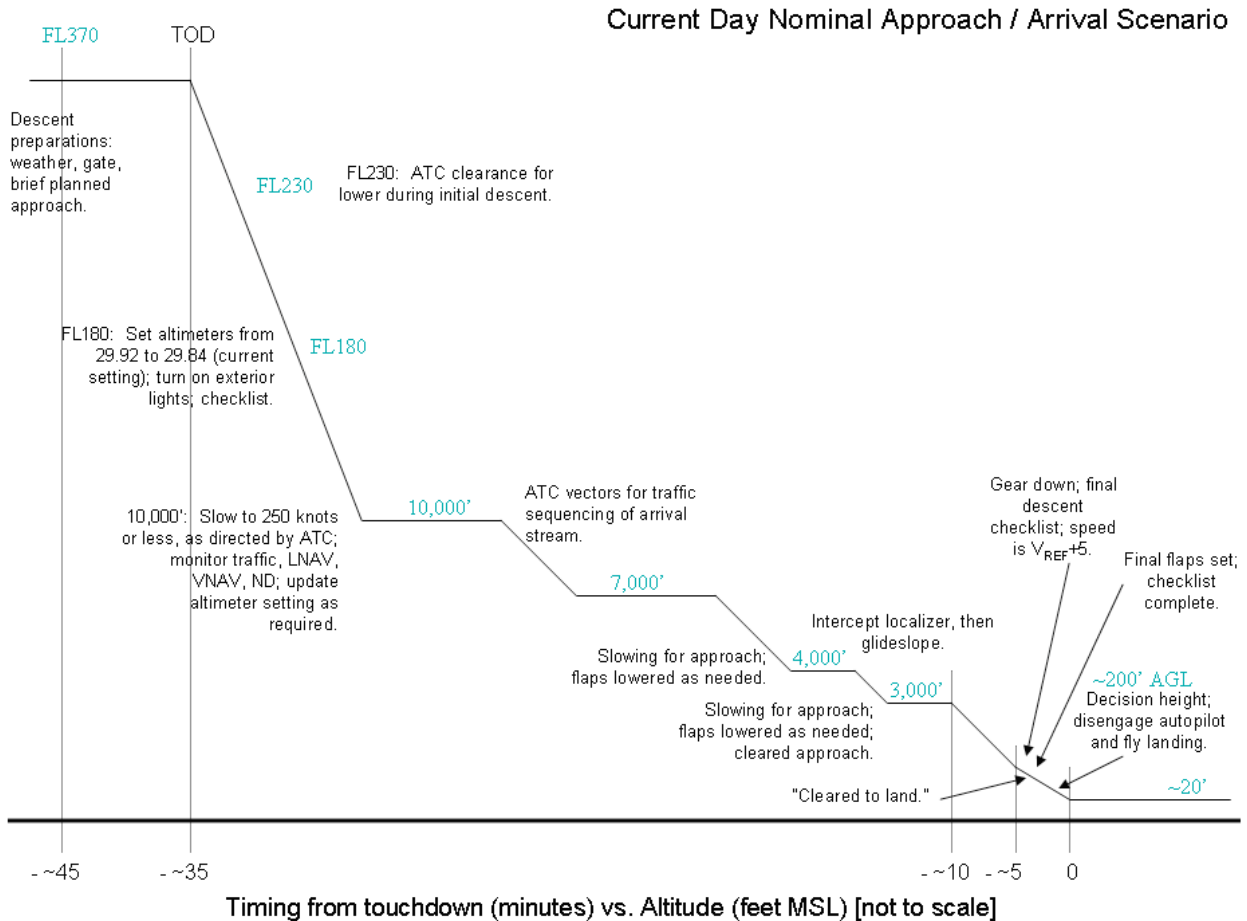

Figure 2.10. Current-day Nominal Arrival Scenario

2.4.2 Departure

United 373 is next in line (#1) for departure on Runway 28L at SFO. The pilots watch the traffic and operations at SFO while listening carefully to the tower frequency in anticipation of being cleared onto the runway. The B-777’s gross weight for takeoff from SFO, bound for HNL (Honolulu), is 520,000 pounds. The CAP is the PF and the FO is the PNF for this leg. They have their respective displays configured for the impending takeoff and departure.

SFO Tower radios UAL 373 to taxi onto the runway and hold in position. The PNF acknowledges the call, while the PF releases the parking brakes, adds power to both engines, and taxis onto the

runway using nose wheel steering via the tiller. While accomplishing this short taxi roll, the captain calls for the final Before Takeoff Checklist items, and turns on applicable external lighting to make the aircraft as visible as possible to others. Simultaneously, the PNF switches the transponder to TA/RA (traffic advisory/resolution advisory – the mode of the transponder to activate replies to ATC radar sweeps and to provide TCAS guidance). When aligned with the runway centerline, the PF stops and waits for takeoff clearance. The PNF calls the checklist complete. A few seconds later, the tower clears UAL 373 for takeoff. As the PNF acknowledges the clearance, the PF turns on all three landing lights and asks the PNF if he is ready to go. The PNF says, “Yes, heading 279” (to confirm the correct runway heading), so the PF smoothly advances the throttles to the approximately vertical position and moves his feet from holding the brakes to the lower portion of the rudder pedals.

Both pilots glance outside, and at the engine instruments, in rapid succession to ensure their B-777 stays aligned with the runway centerline and that the engines look normal. The PF presses a TOGA (takeoff, go around) switch so that the auto-throttles will establish the desired takeoff setting on both engines. The engine roar is audible as the aircraft begins to rapidly accelerate toward flying speed. Both pilots visually check that engine power stabilizes at the desired thrust setting and that airspeed is increasing normally. The PF is mainly concerned with keeping the aircraft properly aligned with the runway centerline, while the PNF glances outside, and at the engine instruments and airspeed. At 80 knots, the PNF calls the speed, checks for normal engine readings, and glances at the PF’s airspeed reading to ensure that everything is in synch. He announces, “Eighty knots; thrust set” to confirm all is well.

Moments later, the F/O calls out “V one” (decision speed) and again ensures there are normal engine readings. The CAP also looks at the engine instruments and moves his right hand from the throttles to the yoke. At this speed, only a catastrophe that makes the airplane unflyable would keep them on the ground, as they now have too much speed to safely stop on the runway. Seconds later, the PNF calls out “V R” to indicate that the rotation speed has been reached, and the PF smoothly pulls back on the yoke to lift the nose to about 15 degrees above the horizon. During the rotation, climb speed (V_2) is typically reached, which the PNF also announces. In this nose-up, level-wing attitude, the B-777 flies off the runway. Both pilots notice this condition as the altitude and vertical speed start to increase and the landing gear “thunk” into the fully extended strut position. As this happens, the PF calls, “Positive climb; gear up” as he flies the B-777 at the desired climb speed and heading. The PNF visually confirms the positive climb and raises the gear handle.

Typically, at this point, the tower directs the pilots to contact departure control on the specified frequency. The PNF switches radio frequency and checks-in with NORCAL Departure by giving them the B-777’s current altitude and cleared altitude. Departure usually responds by clearing the aircraft to a higher intermediate altitude. As part of this initial climb-out process, the PF begins to decrease the climb rate (at about 400 feet above the ground) and commands “Flaps one” (flap setting was 5 for takeoff). The PNF moves the flap handle to 1 and the aircraft accelerates due to less drag. At this time, UAL 373 enters the clouds. Both pilots check the outside air temperature to decide if anti-icing will be needed. While anti-ice activation is automatic, the pilots want to know because of the effect of anti-ice on climb performance, since it uses diverted hot engine air to prevent or melt any ice. Just prior to flaps-up speed, the PF commands “Flaps up,” and the PNF moves the flap handle to the up position.

The PF accelerates to 250 knots in a shallow climb. At 3,000 feet above SFO, he calls for the After Takeoff Checklist. The PNF displays the checklist on the lower EICAS and begins to check items using his CCD. The pilots check their altimeter settings and turn off unneeded lights. Departure control now clears UAL 373 direct to Mendocino (a navaid waypoint on their planned route of flight) and to FL230. As usual, the PNF replies, sets the new altitude in the MCP altitude window, and points to it. The PF also points to the new altitude and confirms it verbally. The PF engages the autopilot and selects Mendocino (ENI) as the next waypoint in his FMS Legs page. Both pilots check the new route on their CDUs and NDs, and then the PF selects execute on his CDU. Both pilots observe the B-777 banking in the correct direction toward ENI.

As UAL 373 climbs above the cloud deck at about 12,000' the PF de-selects terrain (TERR) on his ND and the PNF de-selects weather (WXR). The PNF also moves the weather radar tilt control to full up. Passing 18,000' the pilots set 29.92 in their altimeters and cross-check them. The captain also turns off exterior lights and the passenger seatbelt sign. As the pace of activity lessens, the PNF radios ATC to ask for “ride reports” (reports from prior aircraft of encounters with turbulence). He then announces expected conditions and flying time to HNL to the passengers.

Climbing through FL220, the PNF announces “1,000 to level.” The PF acknowledges and the PNF radios ATC to request a higher altitude. Oakland Center responds that UAL 373 needs to maintain FL230 for crossing traffic. The PNF acknowledges as the autopilot and auto-throttles begin to level the aircraft at FL230, thus ending the departure scenario. This current day nominal departure is illustrated in Figure 2.11.

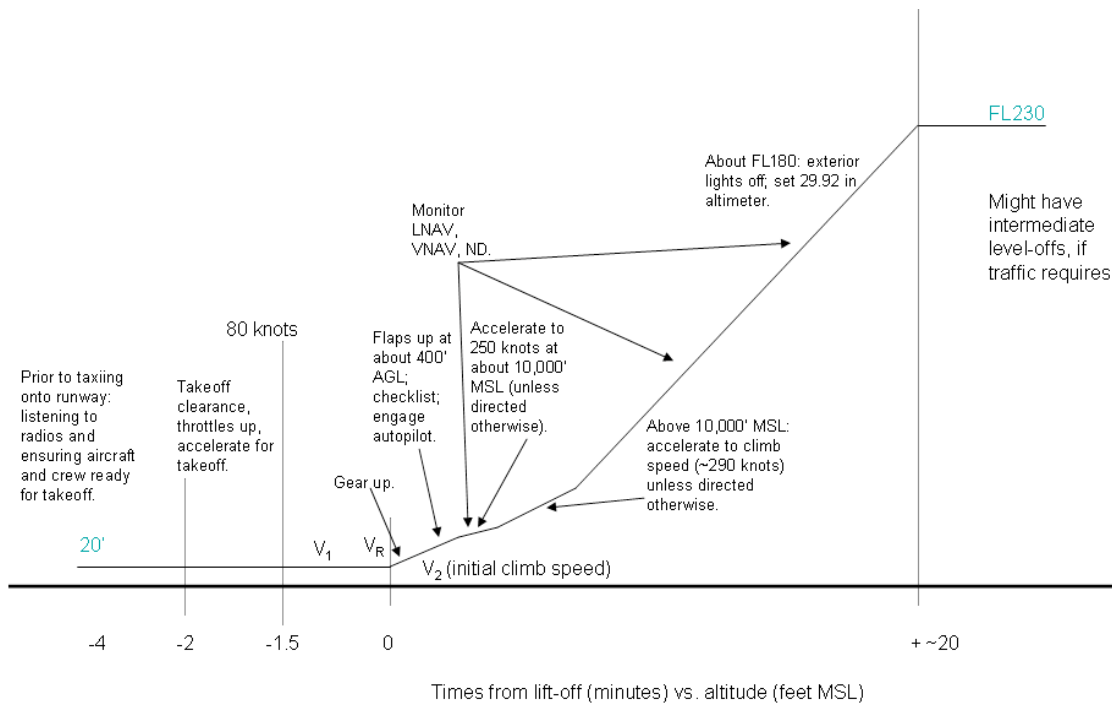

Figure 2.11. Current-day Departure Scenario

2.5 Description of NextGen Super Density Operations

2.5.1 NextGen Concepts

“Super density operations” (SDO) is a term with several meanings within the air transportation research domain. It is one of eight key capabilities identified by the Joint Planning and Development Office that defines the proposed Next Generation Air Transportation System vision (JPDO, 2007). SDO also defines a research focus area for NASA’s NextGen Air Traffic Management (ATM) Airspace Project. SDO has also become a fairly generic term to describe the uniquely constrained and complex challenge of operations at, and near, major airports and terminal area airspace. The characteristics of SDO operations which set it apart from the other air transportation research domains reflect the density and complexity of the operations, the relative immaturity of research to date to address this complexity, the degree to which weather cannot be easily avoided, and the constraints applied by environmental considerations which are not as prevalent in the enroute operational sphere (which has been more fully studied, and is a more mature research discipline) (Isaacson, 2007).

The key to NextGen SDO and what makes SDO so important is that it will enable increased traffic flows at congested airports without the need to construct new runways, which are very expensive, or even new airports at busy metroplexes, which are even more expensive and may be impossible due to the lack of available land.

The following SDO concepts and technologies will make better use of the scarce resources – runways and airspace – at the U.S.’s largest airports:

- ***Closely spaced aircraft*** – separations reduced to much less than today’s standards due to better resolution of aircraft positions and better information available on flight decks that will help avoid midair collisions and wake vortex encounters (see next bullet).
- ***Wake vortex information*** – since current separations are conservative, due in part to the need to avoid wake vortices, reduced separation will require real-time data on wake vortex generation and dispersion. This will require sensors and models to measure and predict wake trails.
- ***Paired aircraft*** – a “daisy chain” of paired leader-follower aircraft, especially on arrival and approach. With more traffic information available on flight decks, airport operations can be conducted in almost any weather condition as if it were a clear VMC day, where, in current-day operations, airliners follow each other to the landing runways. Pairing allows for closer traffic spacing and a smoother arrival flow with less workload for air traffic controllers, managers, and pilots.
- ***Very closely spaced parallel approaches (VCSPA)*** – this might involve paired aircraft, or it might involve groups of three aircraft. These three would be very closely spaced (e.g., 750 ft lateral separation), and the following group of three would be about 2 minutes behind them. This procedure, again, makes better use of the scarce runway resources, especially in marginal weather, which requires more spacing in current-day operations.
- ***Trajectory based operations*** – aircraft will be assigned four dimensional (4D) trajectories (3 spatial dimensions plus time) and expected to meet path and time requirements. Several

NextGen concept developers cautioned that there is much uncertainty in how rigid these requirements will be. The 4D “tunnel” might actually be quite large, and it is currently not known what time precisions will be required.

- **Weather information** – to help ensure that trajectories are achievable, real-time weather data will be provided to ATM and pilots. Since weather is a major factor in reducing airport departure and arrival rates, making real-time weather data and information available will allow for anticipation of weather-related delays and the application of suitable contingency plans in a timely and more efficient manner.
- **Continuous descents & ascents** – for environmental and economic reasons, leveling-off flight will be minimized. Level-offs will be limited to the cruise phase. The more time spent by aircraft at low altitudes, the more fuel burned by those aircraft.
- **Datalink communication with ATM** – rather than voice communication, NextGen communication will be electronic, visual, and text-based (like instant messaging or e-mail). The benefit to this technology is that complex clearances, such as directions for paired approaches or 4D paths, can be communicated more quickly and accurately, and then easily loaded into aircraft FMSs. The downside to datalink clearances is the added visual workload for the pilot, and the fact that mistakes can be more easily over-looked and propagated. Therefore, error (e.g., keyboard entry) and logic (e.g., is there a more efficient path?) checking seem essential to take full advantage of this capability.
- **Uplinked taxi information** – taxi clearances will be provided via datalink before the aircraft lands, thus minimizing the time spent between the runway and parking gate.
- **Equivalent visual operations** – electronically generated out the window view (with synthetic or enhanced vision displays and real-time sensing capabilities) will potentially reduce decision height, and hence better preserve landing capabilities in low visibility.
- **Mixed equipage operations** – many different aircraft with many different capabilities will (potentially) mean prioritized flights, perhaps segmented airspace or timeslots. This has the potential for blunders into airspace, and pilot or ATM errors regarding aircraft capabilities. In current-day operations, aircraft without specified capabilities are not allowed into the most congested airspace (i.e., Category B airspace), so keeping less capable aircraft out of metroplex airspace should improve efficiency. The “flip side of this coin,” though, is that when insufficiently equipped aircraft blunder into more tightly controlled airspace, it is likely that such blunders may cause major delays, inefficiencies, and other impacts.
- **Performance based services** – In the evolving and future (e.g., NextGen) airspace, there are anticipated to be a larger number of different airplane equipage capabilities, such as those enabling self separation. Similarly, current operations accommodate different levels of **required navigational performance** (RNP) such that greater precision can enable more economical operations and trajectories.
- **Self separation** – Aircraft with particular equipment (e.g., the future equivalent of automatic dependent surveillance-broadcast [ADS-B] and a cockpit display of traffic information [CDTI]), will be able to carry out tactical maneuvers to maintain separation from other traffic, in the absence of positive guidance from ATC.
- **Metroplexes** – capacity increases will be met by groups of airports that effectively function as one large airport (e.g., Newark, LaGuardia, and JFK; or San Francisco, San Jose, and Moffet

Field). This may mean more complex traffic patterns into and out of the airports, but more efficient operations overall.

- **Net-centric operations** – NextGen will rely heavily on computerized information systems (e.g., route planning capabilities for 4D trajectories, digital maps, pilot-ATM and pilot-pilot communication, replanning and rerouting capabilities, synthetic vision generation, weather and wake vortex updating and visualization) and the timely exchange of information. This need implies that computing power on the flight deck will need to be much greater than current standards, and that cybersecurity (i.e., network security) is extremely important.

2.5.2 Assumptions Regarding NextGen Displays

NextGen will require that additional information is displayed on the flight deck. While the form of this information (what it will look like) and its location (if it will be integrated into existing displays, or presented on a new display) are uncertain, the project team assumed that the following information is available on the NextGen (circa 2025) flight deck:

- Datalink text and possibly graphical messages
- Wake vortex (WV) information (potentially displayed on the ND)
- Integrated weather information (Note: this is currently on the ND in B-777.)
- Vertical situation display (VSD)
- Location of, and separation from, other aircraft, with particular focus on the lead aircraft (providing coverage beyond the TCAS traffic display) (Note: this is currently included on the ND of the B-777.)
- Equivalent visual operations (EVO) using synthetic vision system (SVS) or enhanced vision system (EVS) information located on a head-up display (HUD) or other flight deck display
- Uplinked taxi clearance (provided via datalink and/or a dynamic airport surface map or head-up display)
- Runway Awareness and Advisory System (RAAS)
- Merging and Spacing
- Electronic Flight Bag (EFB)
- Cockpit Display of Traffic Information (CDTI)

It is also unclear at this stage which technologies will provide traffic information. ADS-B and ADS-X may not have the capabilities (e.g., bandwidth) to transmit all the needed data to support the concepts illustrated in the following figures.

Figure 2.12 shows the Boeing 787 flight deck (from Carriker, 2006). This is included because it accounts for several of the concepts identified above and discussed throughout the NextGen scenarios. This flight deck also provides a possible layout of NextGen displays.



Figure 2.12. A Boeing 787 Flight Deck, Showing Displays and Layouts Relevant for NextGen

Figures 2.13 through 2.21 illustrate various display concepts that the team envisions being included (albeit likely in a more advanced form) in NextGen operations. It is possible that much of this new information will be integrated into existing displays (e.g., weather and wake vortex information integrated into the ND, datalink information on the FMS), or that new displays will be developed. These new displays may also provide data integrated from several sources (e.g., a synthetic vision system that includes enhanced vision system images).

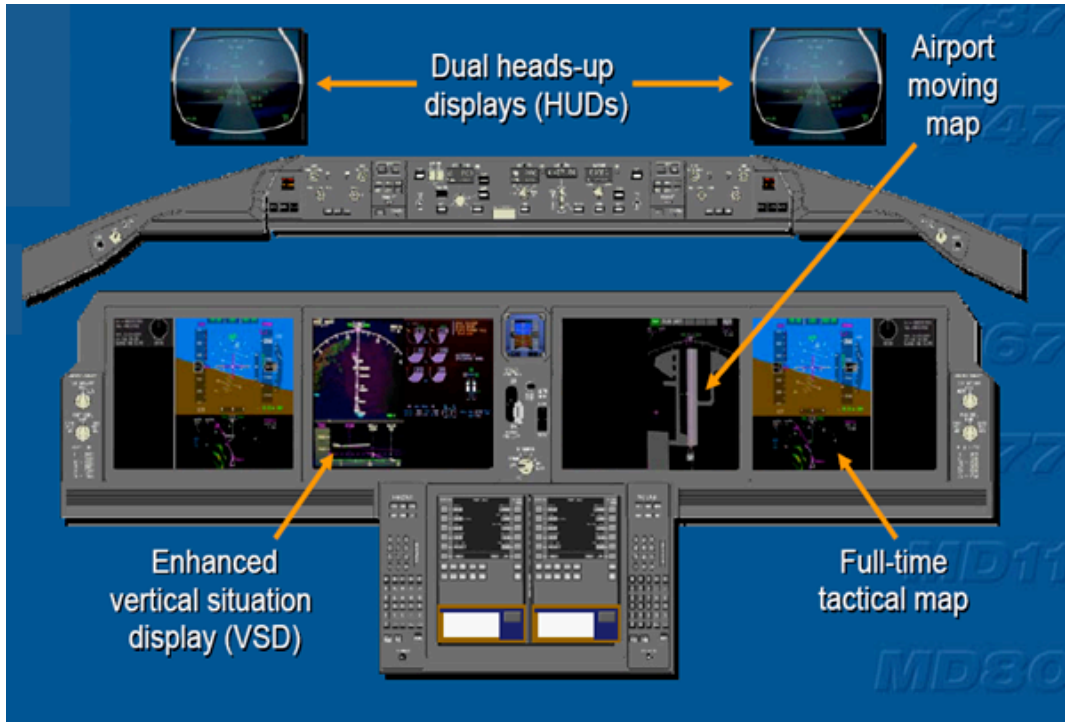

Figure 2.13. A Boeing 787 Flight Deck Layout, Including a VSD and Surface Map. Source: Carriker, 2006.

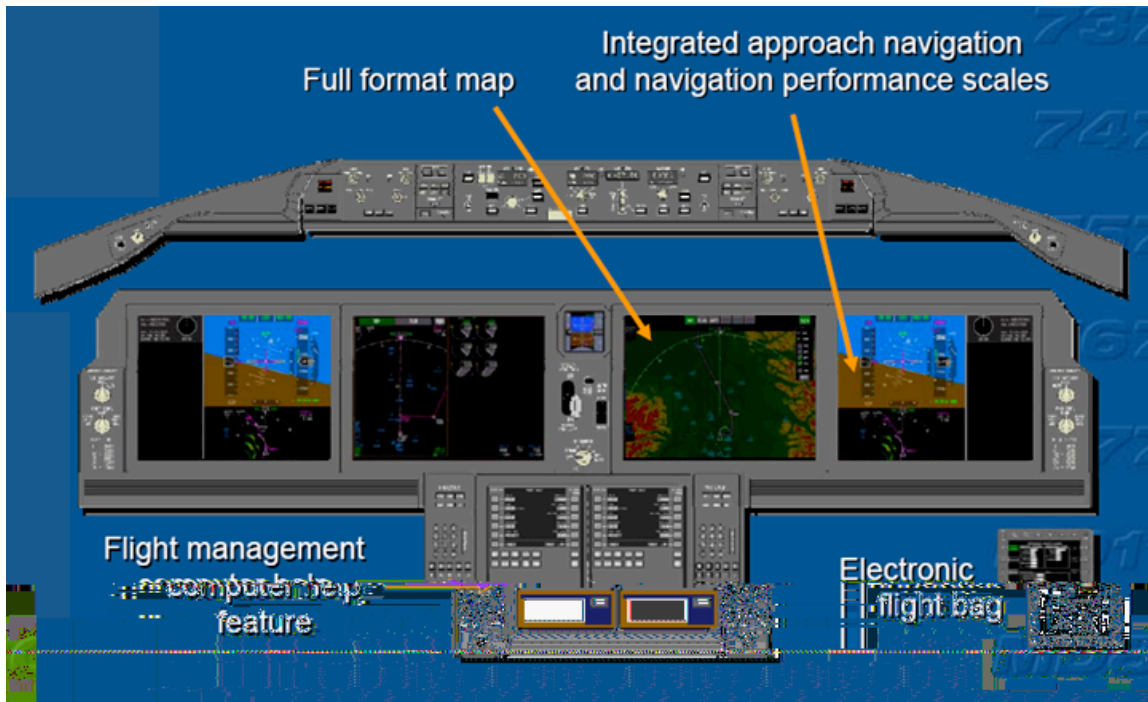

Figure 2.14. A Boeing 787 Flight Deck Layout, Including Integrated Weather Displays and Navigation Performance Data. Source: Carriker, 2006.

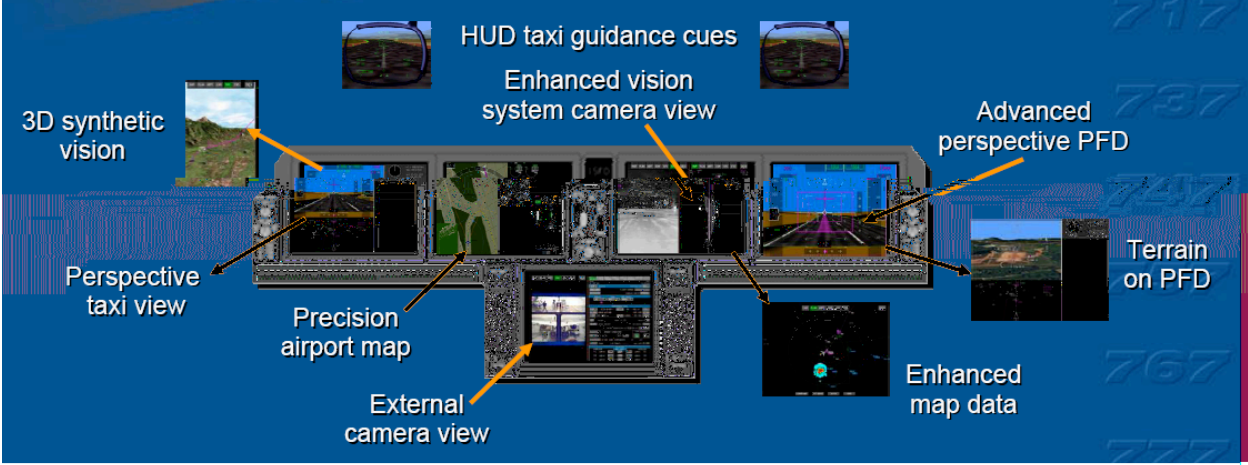

Figure 2.15. A Boeing 787 Flight Deck Layout, Including a Synthetic Vision System, an Enhanced Vision System (Camera Views), Taxi Guidance, and Terrain Data on the PFD. Source: Carriker, 2006.



Figure 2.16. The Electronic Flight Bag on a Boeing 787 Flight Deck. Source: Carriker, 2006.



Figure 2.17. A Potential Surface Map Display Taxiway Navigation and Situation Awareness (T-NASA) Display. Source: Hooey, Foyle, & Andre, 2002.



Figure 2.18. A potential PFD with integrated navigation performance data. Source: Carriker, 2006.

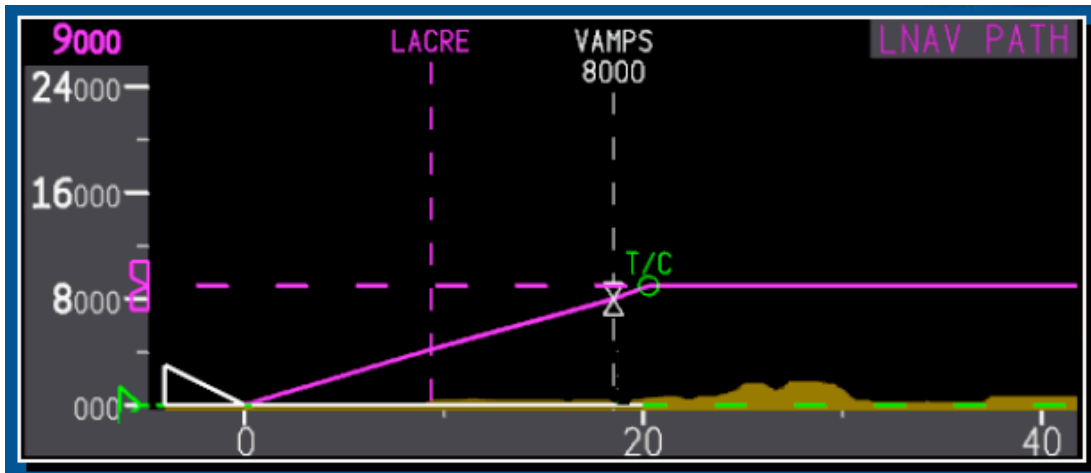

Figure 2.19. A Potential Vertical Situation Display. Source: Carriker, 2006.

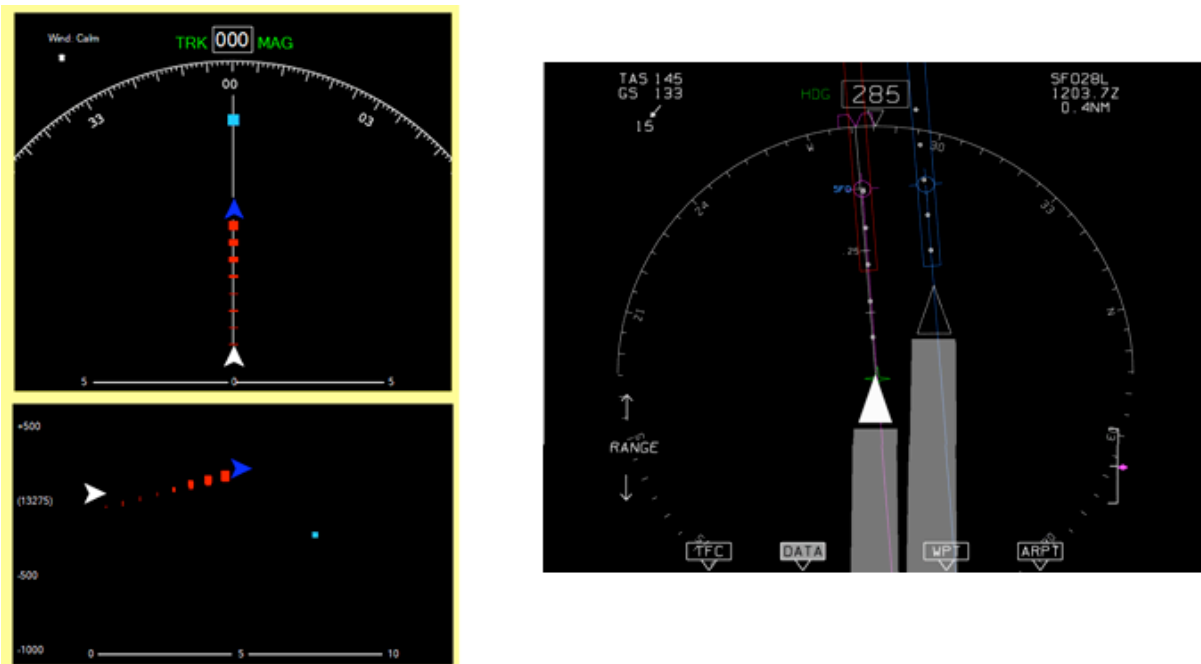

Figure 2.20. Potential Wake Vortex Displays (from Sebok et al., 2006, left, and Hardy & Lewis, 2004, right)

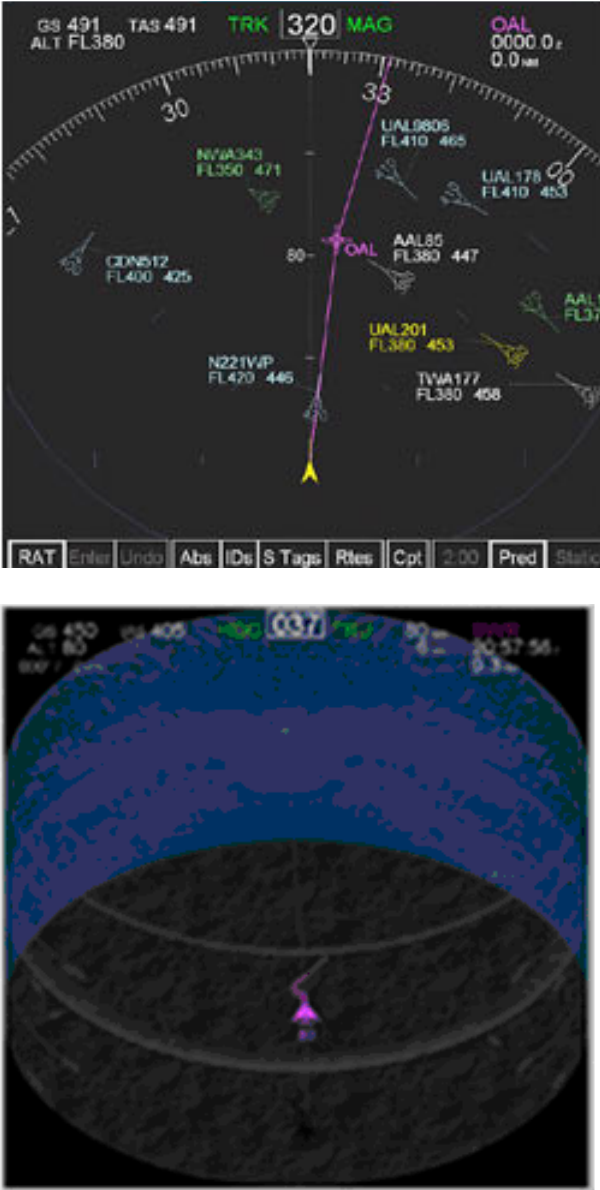

Figure 2.21. Potential Cockpit Display of Traffic Information (CDTI) may be implemented as 2-D (top), or 3-D (bottom) (source: <http://humansystems.arc.nasa.gov/ihh/cdti/cdti.html>)

2.6 NextGen Approach / Arrival Scenarios

The following two sub-sections describe NextGen arrival / approach scenarios, including nominal operations and off-nominal occurrences. This is expected to be representative of long-term NextGen operations (2025).

2.6.1 Nominal Arrival

Some time before the pilot approaches the top of descent, contact is made with ATM at the destination airport (in the current system this is the TRACON, but in NextGen it may be a different organizational element, if TRACON and enroute responsibilities are merged). Through this contact, a 4D arrival and approach procedure will be negotiated. This could involve any number of elements, depending on the evolution of NextGen, and the (related) sophistication of airborne and ground automation.

- It will likely involve a **continuous descent** procedure, unlike today's operations where arriving aircraft are "stepped-down" from their cruise altitudes to progressively lower altitudes to place them in the desired sequence. This will take less time and use less fuel, and be more environmentally friendly (including noise reduction) than current-day arrivals.
- It will probably involve meeting a series of 4D targets in tailored arrivals that are more flexible than today's standard arrivals (STARs).
- It will probably contain instructions for pairing with an aircraft along the arrival route, to transition to a very closely spaced parallel approach (VCSPA).
- It could involve the pilot assuming responsibility for separation assurance, if the aircraft is properly equipped, for example, with ADS-B (or ADS-X, a future version of ADS-B) and CDTI.

On the ground side, the development of most of these tailored procedures will take place as the air traffic manager consults a variety of automation tools, which will recommend solutions and paths (e.g., which aircraft to pair, location of coupling point, routes around weather, 4D targets), for the controller to approve and relay to the pilot. Pilots and controllers will then engage in some form of "contract negotiation" which will take place via a datalink medium. The manner in which the information is actually loaded into a NextGen FMS remains uncertain. It could be loaded by pilot transcription into the CDU or, given that information is digitally available in the cockpit, it could directly enter the CDU with a single pilot "accept" command. Clearly there are opportunities here for some dialogue, as pilots may wish to accept only parts of the "contract" offered by ATM.

Once past TOD on the arrival, assuming the FMS guides the 4D trajectory (4DT), the pilots will be engaged in continuous monitoring, with particular emphasis on assuring that 4D targets are achieved, and that flying precision is within the bounds of required navigation performance (RNP). To ensure separation, pilots will also monitor the CDTI. Also two discrete events could occur during the first half of the arrival: a coupling point with a paired aircraft for the VCSPA procedure, and an uplinked taxiway clearance. The former will be followed by communications with the paired aircraft; and the latter, possibly, by entry into a taxi-guidance system (e.g., surface management

automation). In addition, there are possibilities for added uplinked information from ATM, related perhaps to recommended weather deviations. While it is assumed that most of this routine communication will occur via datalink, it is expected that a voice communications backup will always be available. Voice communication could be easily adopted, even in routine exchanges, if information cannot be easily relayed via “texting” (e.g., pilot needing to explain why new trajectories should not be flown, or ATM explaining why they must be flown).

As the pilot continues the arrival, the CDTI, weather display, RNP display, and a wake vortex display will receive periodic visual attention, but pilots will likely rely heavily on attention-grabbing alerts to inform them if problems develop. Some time during this later arrival period, pilots will configure the runway awareness and advisory system (RAAS) display (Honeywell, 2010). The RAAS display (currently a verbal alert³, but potentially a visual display in NextGen) presents landing information based upon current aircraft weight and anticipated runway conditions. It informs the pilots if their flight parameters remain within bounds for a safe on-speed landing that will assure remaining on the runway.

In addition, pilots will closely monitor an E/SVS display (SVS combined with EVS) especially in IMC. Such monitoring will be done in parallel with traffic monitoring for the VCSPA, as the latter will probably be rendered on a separate high-resolution display. At some height above the runway (HAR), pilots will make the standard land or go-around decision, depending on whether they have visual contact with the runway, as it will be viewed through an EVS-generated image. The two-person crew will follow precise coordinated procedures in making this decision, as they continue to monitor the paired aircraft. Following touchdown, assuming degraded visibility, pilots now closely consult a taxi navigation display, both to monitor their deceleration and approach to turn-off, and to follow the taxi route to the gate.

Naturally overlaid on this description of anticipated nominal NextGen procedures will be the standard list of many current procedures, such as configuring the aircraft, monitoring ATIS (probably via datalink), monitoring engine parameters, and cockpit checklists. What may be missing during nominal approaches is any voice communications with ATC, at least for routine procedures.

Figure 2.21 depicts this episode graphically in a time line, and following the figure, a series of brief narratives are provided for each of the discrete and continuous nominal events and activities. This will serve as a backdrop for the description of off-nominal events in Section 2.6.2. It should be noted that this list is not exhaustive, in that many events represented in the current-day event scenarios will still exist here (e.g., landing gear, checklists). They are not overlaid in this representation in order to focus attention on those specific events tied to NextGen technology and procedures.

The following list describes nominal events that are depicted within the profile of an arrival / approach sequence shown in Figure 2.22. For many such events, the altitude along the path at which they occur is somewhat arbitrary, although some are constrained in the range of altitudes at which they could occur.

³ Richard Shay, B-777 pilot and project pilot SME. July, 2008, personal communication.

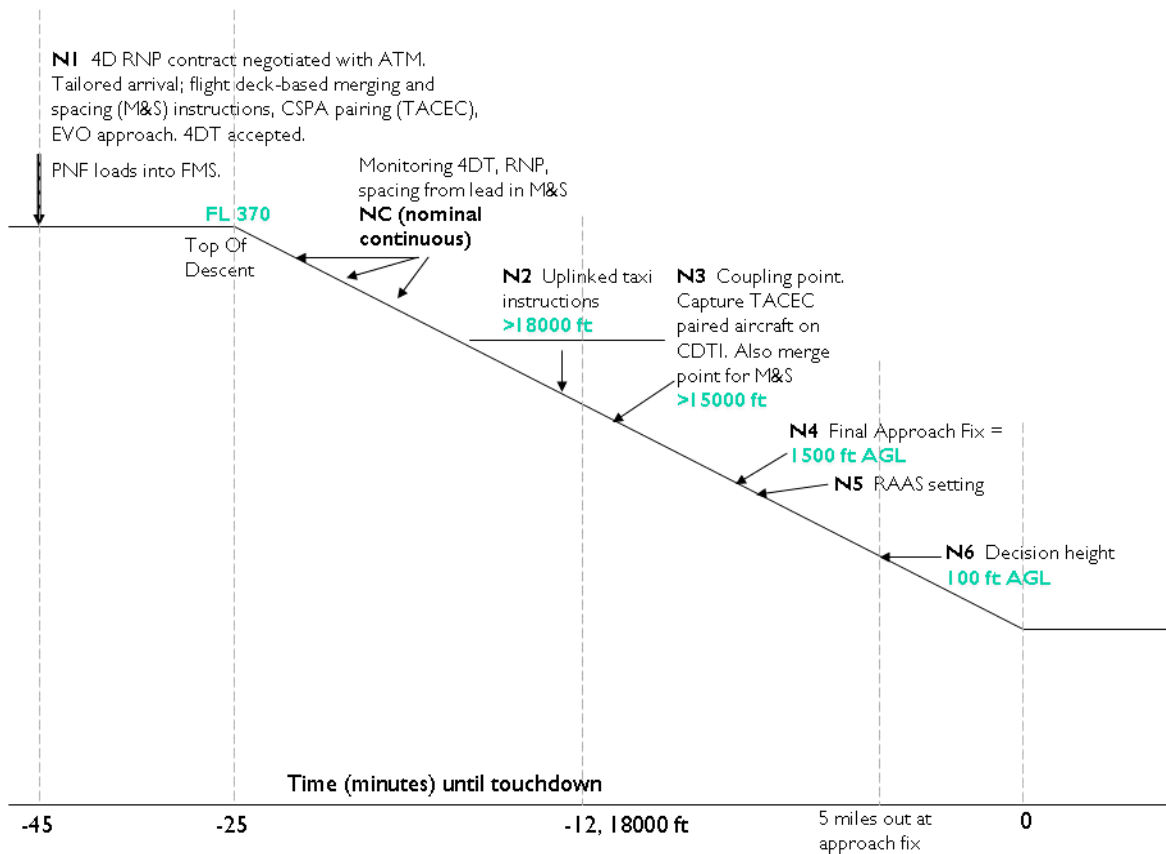

Figure 2.22. Nominal Event NextGen Approach/Arrival Scenario

N1. Uplinking and loading of 4DT contract approach. When information necessary to fly a 4D trajectory approach is uplinked (a 4D contract), there will be some dialogue with information exchanged, quite possibly via datalink. This exchange may be more complex if coupled with a terminal area capacity enhancing concept (TACEC; Miller, Dougherty, Stella, & Reddy, 2005; Verma, Lozito, Kozon, Ballinger, & Resnik, 2008), such as VCSPA pairing, since it will require procedures at a downstream coupling point.

N2. Uplinked taxi clearance. It is expected that ATC will uplink a taxi clearance to the aircraft, ideally above 18,000 feet HAR, so that the workload of evaluating these instructions is not imposed on final preparations for the approach and landing. This may take the form of a full 4D taxi clearance (i.e., a taxi clearance with required time of arrivals associated with checkpoints such as runway crossings or arrival at gate). Alternatively, the clearance may include only the first segment of a taxi clearance to increase runway exit efficiency.

N3. Coupling point. If a paired approach is to be flown for a VCSPA, there will be a point at which contact is made with the paired aircraft, and, presumably it is located on a CDTI. If a merging and spacing operation is contracted, this is the merge point (Hoffman *et al.*, 2005). Discussions with pilot SMEs suggest a preference for this above 15,000 feet.

N4. Final approach fix. While this clearly exists in current operations, it could have implications for the future. It is included here because even in NextGen operations it is expected to remain an important landmark in terms of final preparations for landing.

N5. RAAS setting. The Runway Awareness and Advisory System (RAAS) (Honeywell, 2010), or a similar system, will monitor aircraft energy parameters on approach, and to alert the pilots if outside acceptable bounds (i.e., too fast, too slow, too high, or too low). Presumably this system will have access to aircraft weight, wind, and runway conditions to calculate safe bounds. It is an open question whether or not this system will be fully automated or set by the pilots. It is also not known if this information will be presented verbally (as it is today) or visually.

N6. Decision height in an IMC approach. This is a standard event, although the HAR may vary depending on aircraft equipage. For example, it is likely that an aircraft equipped with EVO or EVS displays will have lower decision heights. Current NASA Langley work (Kramer, Bailey, & Prinzel, 2009) estimates decision height to be 100 feet HAR for EVS-equipped aircraft in a low visibility landing.

2.6.2 Off-Nominal Arrival

Figure 2.23 illustrates potential off-nominal events (labeled ON) associated with the arrival and approach phases of flight. This figure also shows the nominal arrival events (labeled N) for comparison purposes. Off-nominal events are presented in red, below the timeline. We emphasize that our presentation here is *restricted only to off-nominal events that are directly related to NextGen technology and its associated procedures*, either **caused** by breakdowns of that technology, or heavily mediated by the technology. Thus there are numerous off-nominal events – such as engine failure, pilot incapacitation, unpredicted severe weather disturbances, or structural damage – that occur in current-day scenarios. While these are critical, and could well be laid on top of the following catalogue of off-nominals, their identification and description is not intended as part of this Phase I report.

One additional off-nominal that deserves highlighting, even though it occurs in current scenarios, is the FMS-based “surprise” (Sarter & Woods, 2000). This is a circumstance in which the FMS carries out an action that was not anticipated by the pilots, or fails to carry out an action that was anticipated (e.g., continue cruise beyond the anticipated TOD). The causes of such surprises lie within the complexity of, and coupling between, the FMS’s many modes, and the fact that pilots may not always be aware of the implications of mode changes or of temporary departures from planned flight paths. In the profiles presented below, we do not represent such FMS surprises, as they could occur at any point during arrival, approach or departure and, as noted, they occur within present day operations. However, we mention FMS surprises here because the increased automation in both air and ground systems likely to accompany NextGen procedures and technology, can make such surprises (and similar ones) more likely.

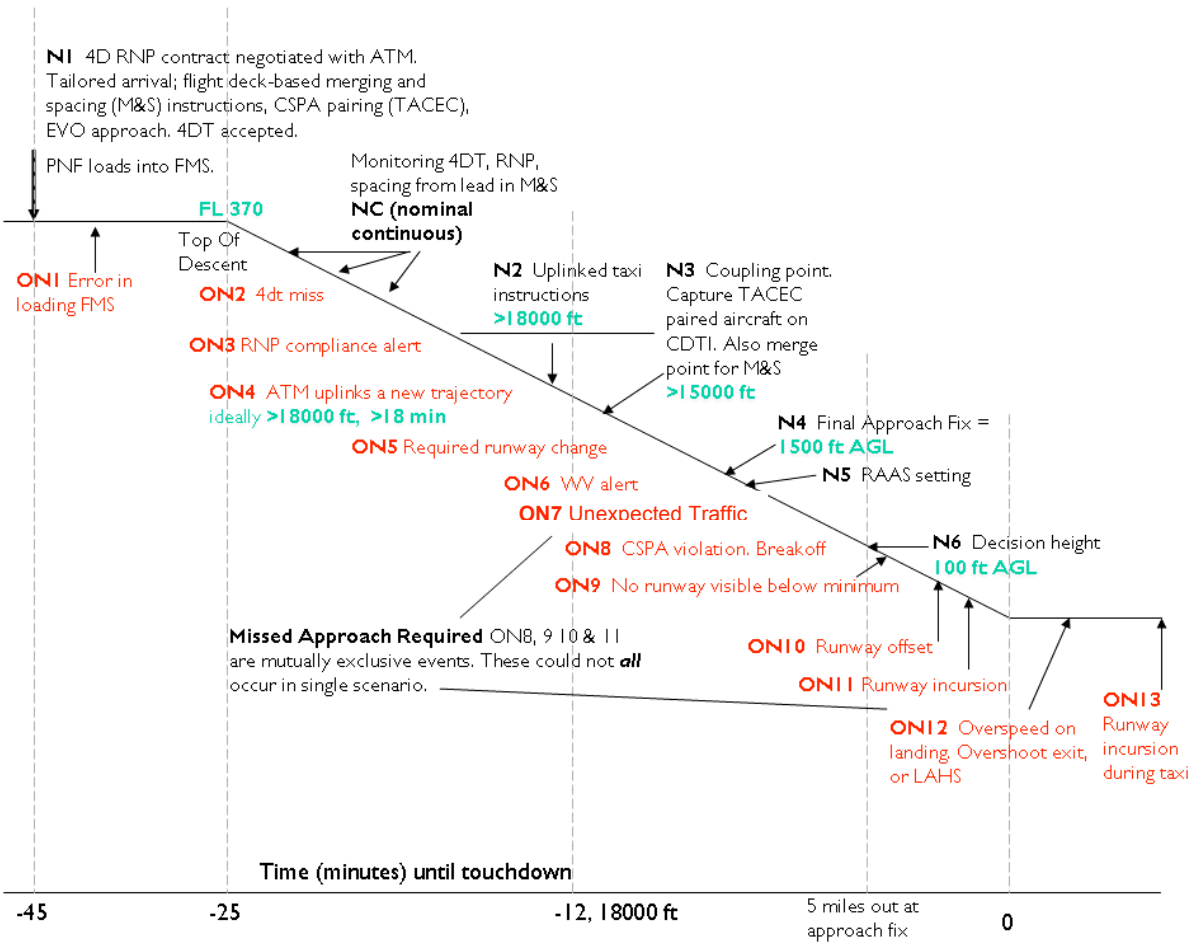

Figure 2.23. A NextGen Arrival Scenario with Nominal and Off-Nominal (ON) Events

The following off-nominal descriptions, below, include a text summary of the off-nominal event as well as additional information. Attributes including expected frequency, location where information is visible, and when in the arrival the event might happen are also presented. Frequency was subjectively estimated, with SME input, as Moderate, Low, and Rare based upon how often, in the typical pilot’s arrival / approach, the event might occur.

ON1 Data input error

- a. *Description:* As noted above, when information necessary to fly a 4D trajectory approach is uplinked (a 4D contract), there will be some dialogue with information exchanged, quite possibly via datalink. This exchange may be more complex if coupled with a TACEC (including VCSPA pairing), or merging and spacing instructions since it will require procedures at a downstream coupling point. Depending on how this dialogue is implemented, there are multiple opportunities for error. (1) If pilots must type it into the FMS or a flight deck merging and spacing (FDMS) entry device, there is the potential for keyboard entry errors. (2) If a datalink can be automatically loaded into the FMS or FDMS tool (with a pilot “accept” key), then there are opportunities to accept an “unflyable” trajectory (e.g., ATM errors in defining a 4D target that cannot be met with current airspeed limits). (3) Finally, the database used by ATM may be faulty. For example, in configuring a 4D arrival, it may fail to correctly integrate the forecast of bad weather, or to incorporate a hazard (e.g., radio tower) recently erected near the approach. There are, of course, a variety of ways in which such off-nominal events can be “noticed” in the cockpit, and hence variety of potential failures of noticing. Datalink protocols will be carefully analyzed to assess these. The time at which these off-nominal events may occur prior to TOD is uncertain. Note that this will also apply to uplinked taxi information.
- b. *Frequency:* Low.
- c. *Location:* Comparison of datalink display (or loaded FMS parameters) with mental expectations. There will probably not be an explicit warning if such expectations are violated (Olsen & Sarter, 2001).
- d. *Time window:* Prior to TOD for the original “contract.” Any time during arrival sequence for other datalink information exchange (e.g., uplinked taxi information). The time window for **noticing** the error however could be anywhere from the initial exchange to touchdown.

ON2 4DT miss

- a. *Description:* Given a “4D contract” with 4D targets, it is possible that these can be missed in any number of dimensions. For example, a waypoint can be reached too early or too late; or, the right waypoint can be reached at the right time, but too low. While the 4DT is a concept for NextGen, near term examples are those in which 3D targets, gates, or restrictions are missed (or predicted to be missed). Another example is loss of separation on a continuous descent approach with flight-deck-based merging and spacing. Such an off nominal event has two implications. First, it will probably need to be corrected. Second, it is an indication that the RNP limits (which were “contracted” at the time the approach was negotiated) may have been exceeded and need to be re-negotiated (see also ON3).
- b. *Frequency:* Low.
- c. *Location:* Probably will be an ND alert.
- d. *Time window:* Between TOD and final approach fix.

ON3 RNP compliance failure

- a. *Description:* See above. It is likely that this will occur whenever a 4D target is missed; but, it might occur at other places between targets, when there is a degradation of the aircraft's navigation system (e.g., GPS), or a degradation of the performance characteristics of the airplane to achieve the required trajectories (e.g., due to icing).
- b. *Frequency:* Low.
- c. *Location:* Currently the RNP alert is located on a separate display.
- d. *Time window:* Between TOD and final approach fix.

ON4 Uplinked new trajectory

- a. *Description:* This might occur whenever the computed flight plan must be revised, due to weather changes or trajectory changes of an aircraft with which ownship is paired (e.g., the lead aircraft for merging and spacing, prior to the merge point; or the paired aircraft for VCSPA). This off-nominal has many shared characteristics with ON1, which will not be repeated here.
- b. *Frequency:* Moderate, particularly in crowded airspace and uncertain weather.
- c. *Location:* Datalink display (with chime) or ND CDTI for new trajectory information regarding paired or lead aircraft.
- d. *Time window:* Between TOD and final approach fix.

ON5 Required runway change

- a. *Description:* This off-nominal will occur whenever wind shifts at the airport change the landing runway; or other ground events, such as the closure of a runway because of unexpected circumstances.
- b. *Frequency:* Moderate.
- c. *Location:* Datalink display initially, then ND.
- d. *Time window:* Between TOD and final approach fix.

ON6 Wake vortex alert

- a. *Description:* A change in wind or turbulence blows a wake vortex of a leading, higher aircraft into the predicted flight path. In current procedures, conservative separation standards are used to avoid WV encounters. In NextGen, this will be automatically determined by WV alert software.
- b. *Frequency:* Low, since separation standards should be predicated on characteristics of nearby traffic.
- c. *Location:* ND, assuming that WV data will be presented on the ND (Sebok *et al.*, 2006).
- d. *Time window:* Increasingly likely as final approach fix or merge point for paired approaches is neared. This particular off-nominal will be more likely on departure and climb out, where leading aircraft are more likely to be in front and **above** the alerted aircraft, as WVs descend from the generating aircraft.

ON7 Unexpected traffic

- a. *Description:* A nearby aircraft suddenly appears on the CDTI. This could result because the technology enabling broadcast of traffic location was temporarily inoperable and resumed working, or a non-equipped (for self separation) aircraft unexpectedly flew into controlled ASDO airspace. It could also occur due to imperfections in traffic location broadcast transmissions in a highly cluttered airspace. Alternatively, traffic may disappear as broadcast transmissions fail. This is a critically important distinction (popup vs. disappearance) as humans are notoriously poor at noticing event “offsets” (i.e., the absence of data).
- b. *Frequency:* Low.
- c. *Location:* CDTI. However it is not clear whether CDTI will be a stand-alone display, or will be embedded into the ND (as current TCAS info is).
- d. *Time Window:* Broadcast failures equally likely at all points along approach. VFR (general aviation) popups of non-equipped (VFR aircraft) are increasingly likely at lower altitudes (later in approach).

Missed approach off-nominals

The following four off-nominal events (ON8 – ON11) are those that would trigger a missed approach, and hence more than one of them would not be likely to occur during a single flight.

ON8 VCSPA violation

- a. *Description:* Pilots flying a very closely spaced parallel approach, when one aircraft alters trajectory in a way to force a decoupling, and break-off. This event would include circumstances in which inappropriate pairing of a heavier with a lighter aircraft could mean that the former was unable to fly slow enough, or the latter fast enough, to maintain necessary separation.
- b. *Frequency:* Low; an important distinction would be whether the trajectory change is away from danger (ownship) or toward. The former might allow the approach to continue. The latter certainly would not.
- c. *Location:* Designated VCSPA display (parallel approach monitoring or PAM display), embedded within the ND.
- d. *Time window:* Increasing from impossible (at coupling point) to most likely (100 feet HAR).

ON9 No runway visible at decision height

- a. *Description:* Runway is not visible at decision height (DH). This will vary depending on the equipage of the aircraft. For example, EVS or EVO equipped aircraft should allow a lower DH.
- b. *Frequency:* Moderate; Some (Kramer, Bailey, & Prinzl, 2009) have not really treated this as “off nominal” at all.
- c. *Location:* Out-the-window (OTW) view, coupled with altitude monitoring.
- d. *Time window:* Below a few hundred feet HAR.

ON10 Runway offset

- a. *Description:* Error in HUD or SVS runway outline that positions this outline offset from the position of the true runway. In analogous current conditions, this could be an offset of the ILS localizer.
- b. *Frequency:* Rare.

- c. *Location*: OTW view.
- d. *Time Window*: Below DH

ON11 Runway incursion on final

- a. *Description*: An obstacle, such as a snow plow or deer on the runway. This refers specifically to an obstacle that is not rendered on the EVO display, and hence becomes evident only at breakout.
- b. *Frequency*: Rare.
- c. *Location*: OTW view.
- d. *Time window*: Below ceiling.

ON12 Overshoot runway exit or fail to hold short of intersecting runway

- a. *Description*: Landing long or simply missing the cleared runway exit, or failing to hold short of an intersecting runway when instructed to do so. This could happen if the RAAS (see N5) was not functioning correctly by failing to alert pilots as to violations of energy parameters, or if incorrect information about the exit or hold short point was entered.
- b. *Frequency*: Moderate.
- c. *Location*: OTW view or taxi navigation display.
- d. *Time window*: After touch-down.

ON13 Incursions on the ground

- a. *Description*: These are similar to ON11, but refer to obstacles, which on-board automation fails to notify, which have occurred after wheels down. The capability to identify these incursions depends on a surface management automation system, as well as communications from all ground surveillance systems.
- b. *Frequency*: Rare.
- c. *Location*: OTW view.
- d. *Time window*: After touch-down.

These off-nominals are presented as modified Murphy Diagrams in Figures 2.24 through 2.36. Instead of identifying proximal and distal contributors to incidents, as traditional Murphy Diagrams do (Kirwan & Ainsworth, 1992), these diagrams identify contributors in terms of the relevant environmental, management, human and machine factors (also presented in Table format in Appendix G). These diagrams were generated by the project team and the pilot SME, and were refined as a result of discussions with an ATC SME, the pilot focus group, and NASA concept developers.

APPROACH ON1

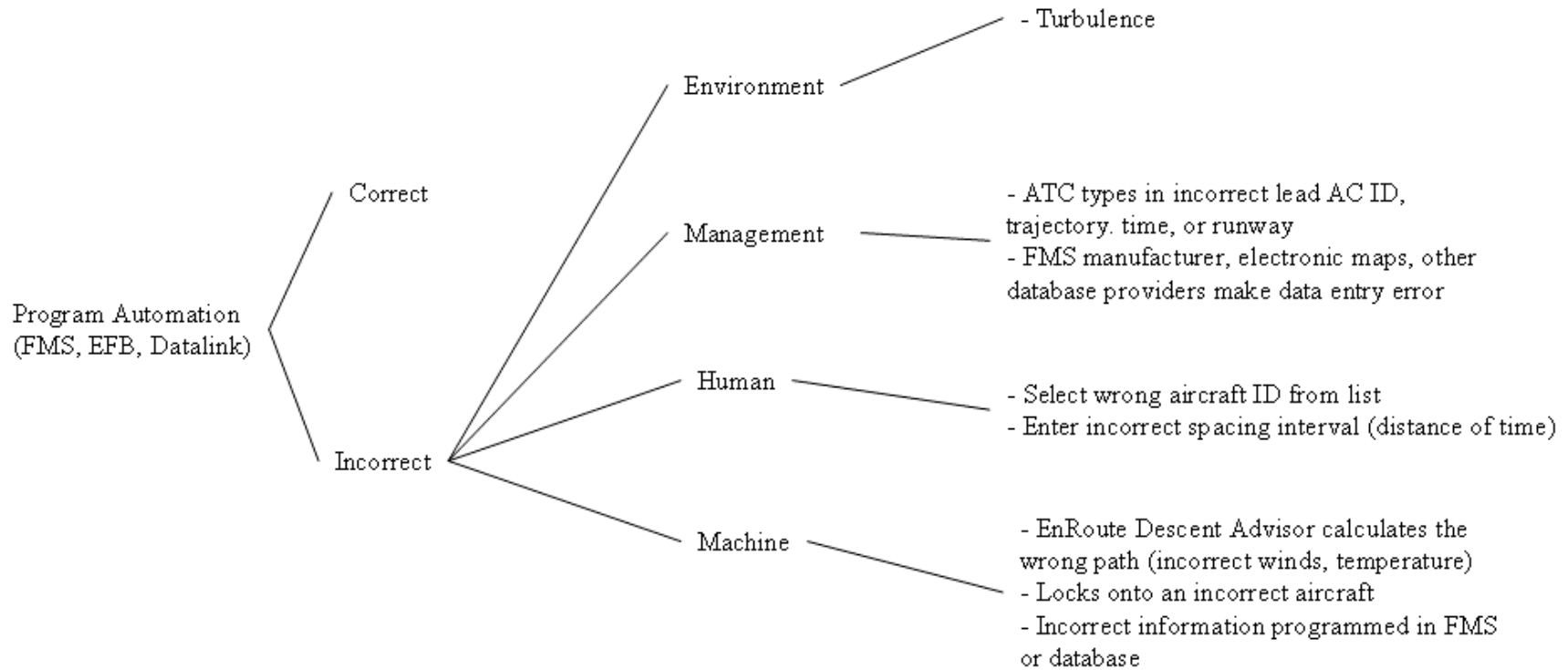
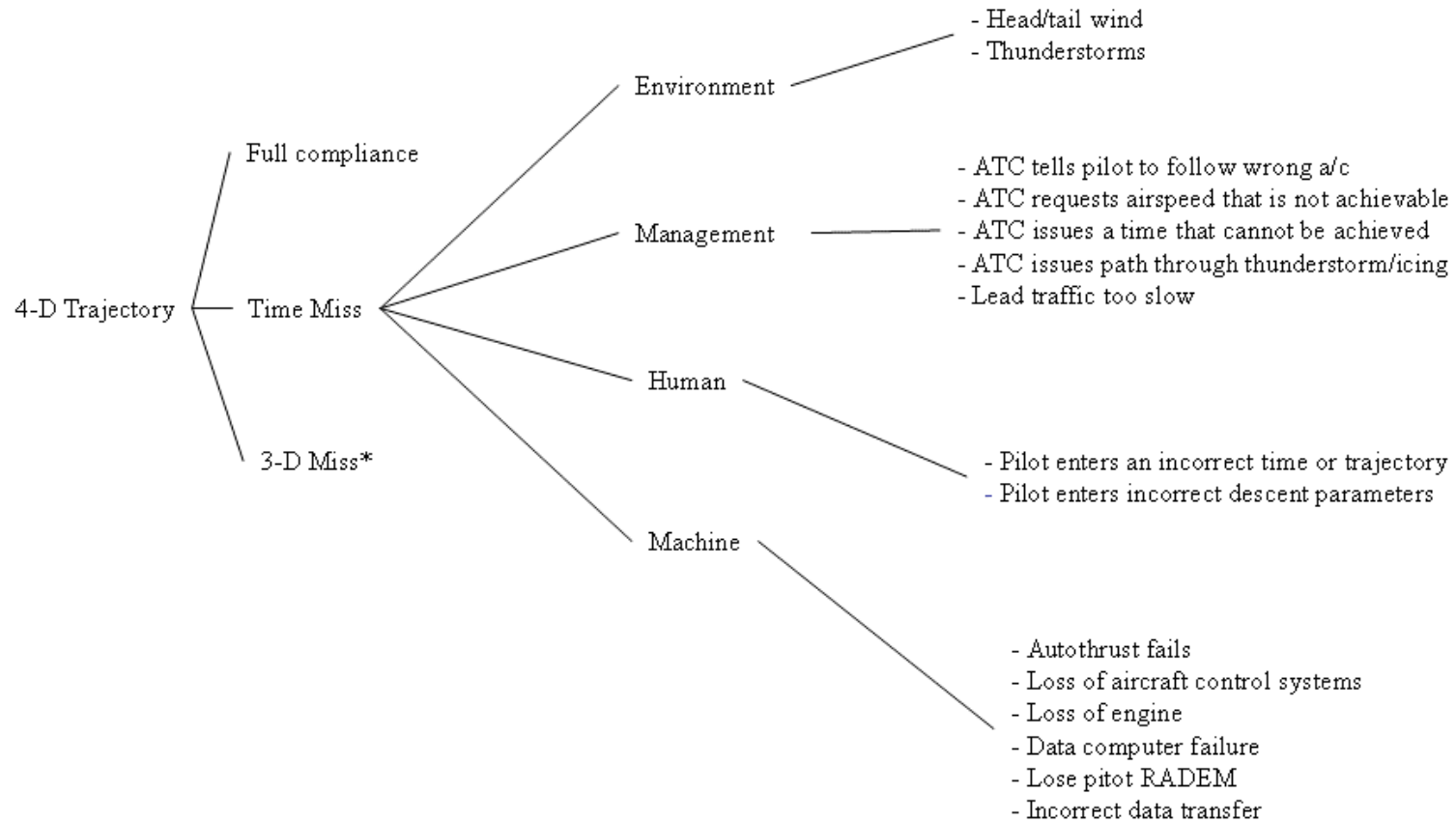

Figure 2.24. Murphy Diagram of NextGen Arrival / Approach Off-Nominal 1

APPROACH ON2



*3D miss not addressed, as it is not unique to NextGen operations

Figure 2.25. Murphy Diagram of NextGen Arrival / Approach Off-Nominal 2

APPROACH ON3

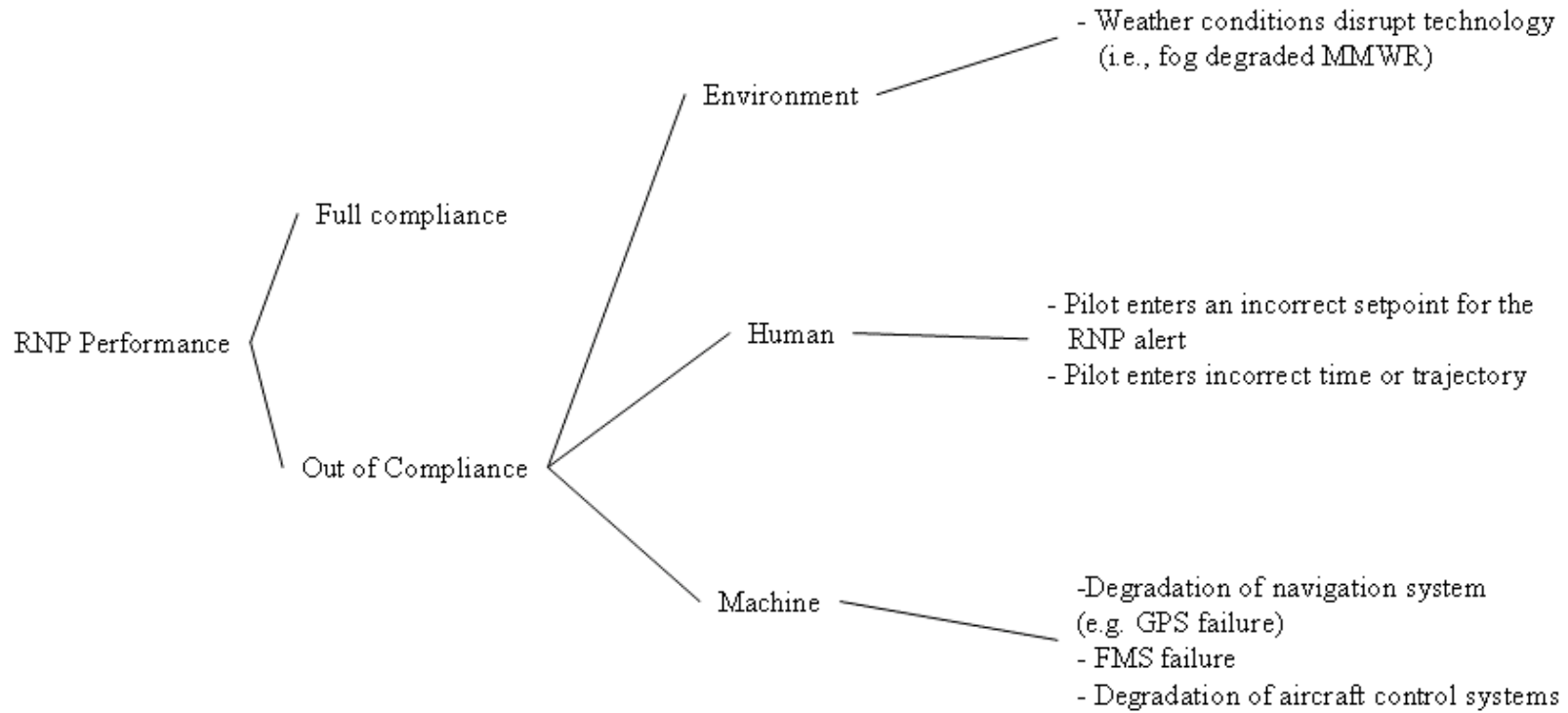

Figure 2.26. Murphy Diagram of NextGen Arrival / Approach Off-Nominal 3

APPROACH ON4

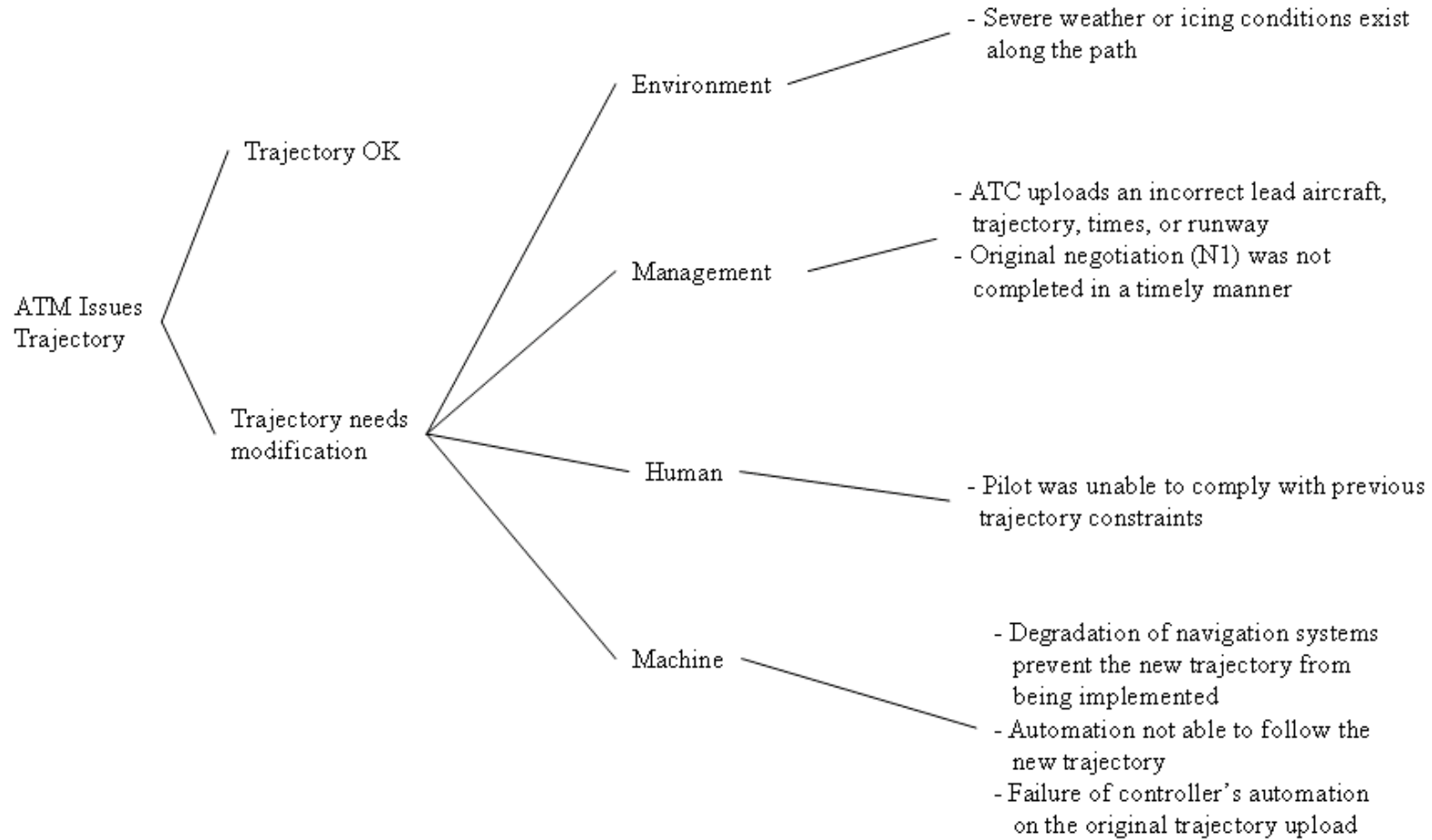

Figure 2.27. Murphy Diagram of NextGen Arrival / Approach Off-Nominal 4

APPROACH ON5

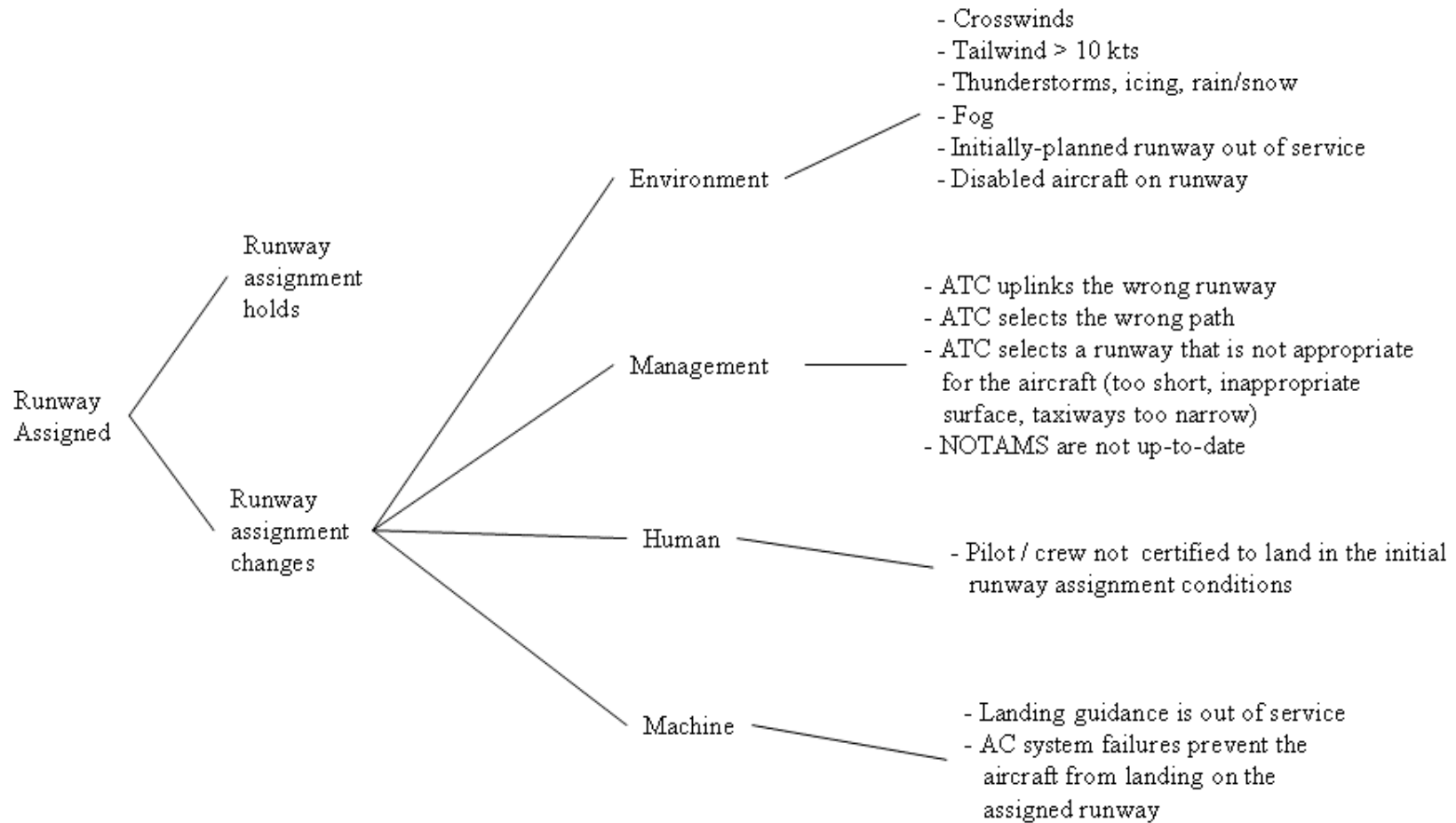

Figure 2.28. Murphy Diagram of NextGen Arrival / Approach Off-Nominal 5

APPROACH ON6

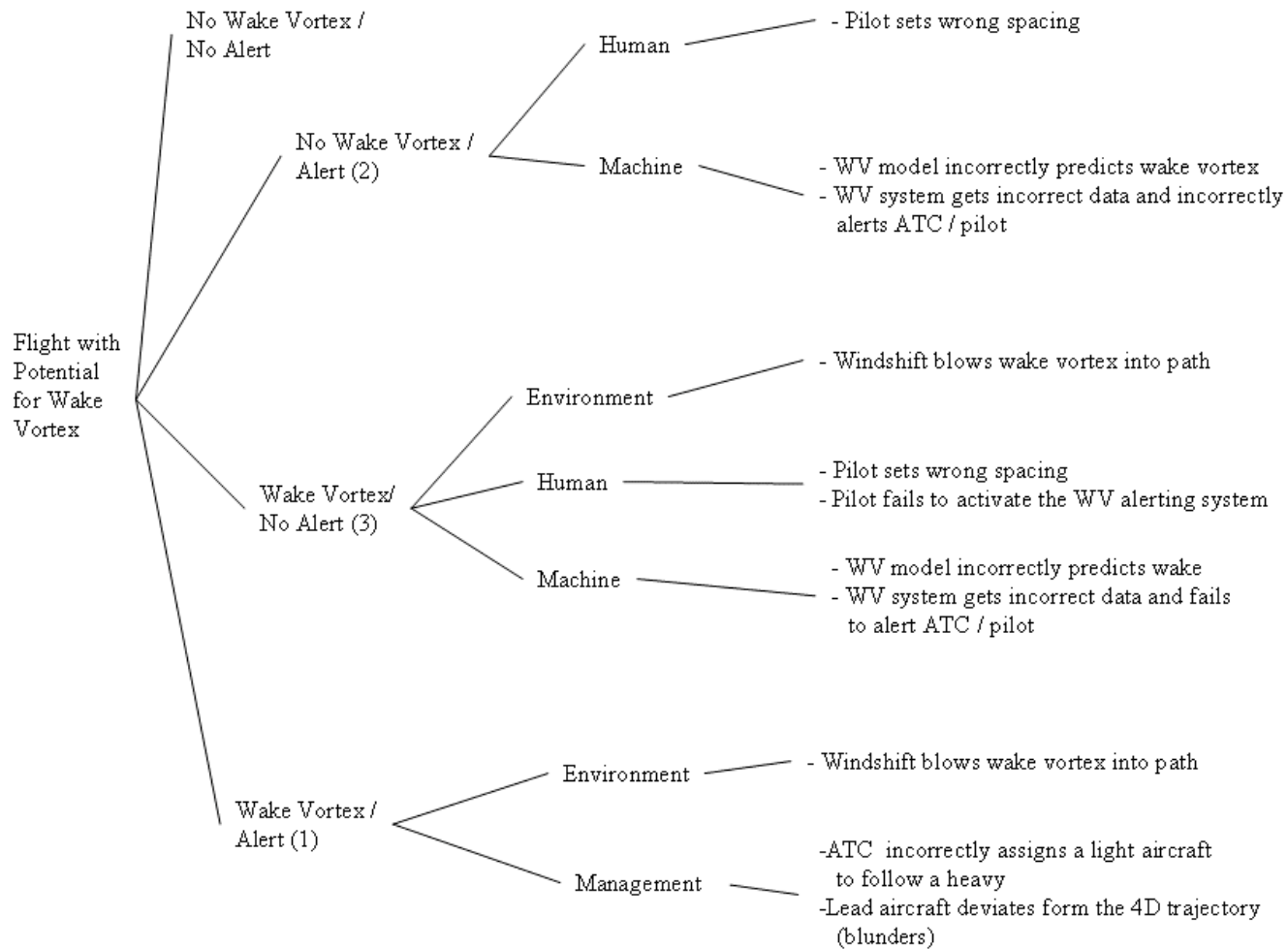

Figure 2.29. Murphy Diagram of NextGen Arrival / Approach Off-Nominal 6

APPROACH ON7

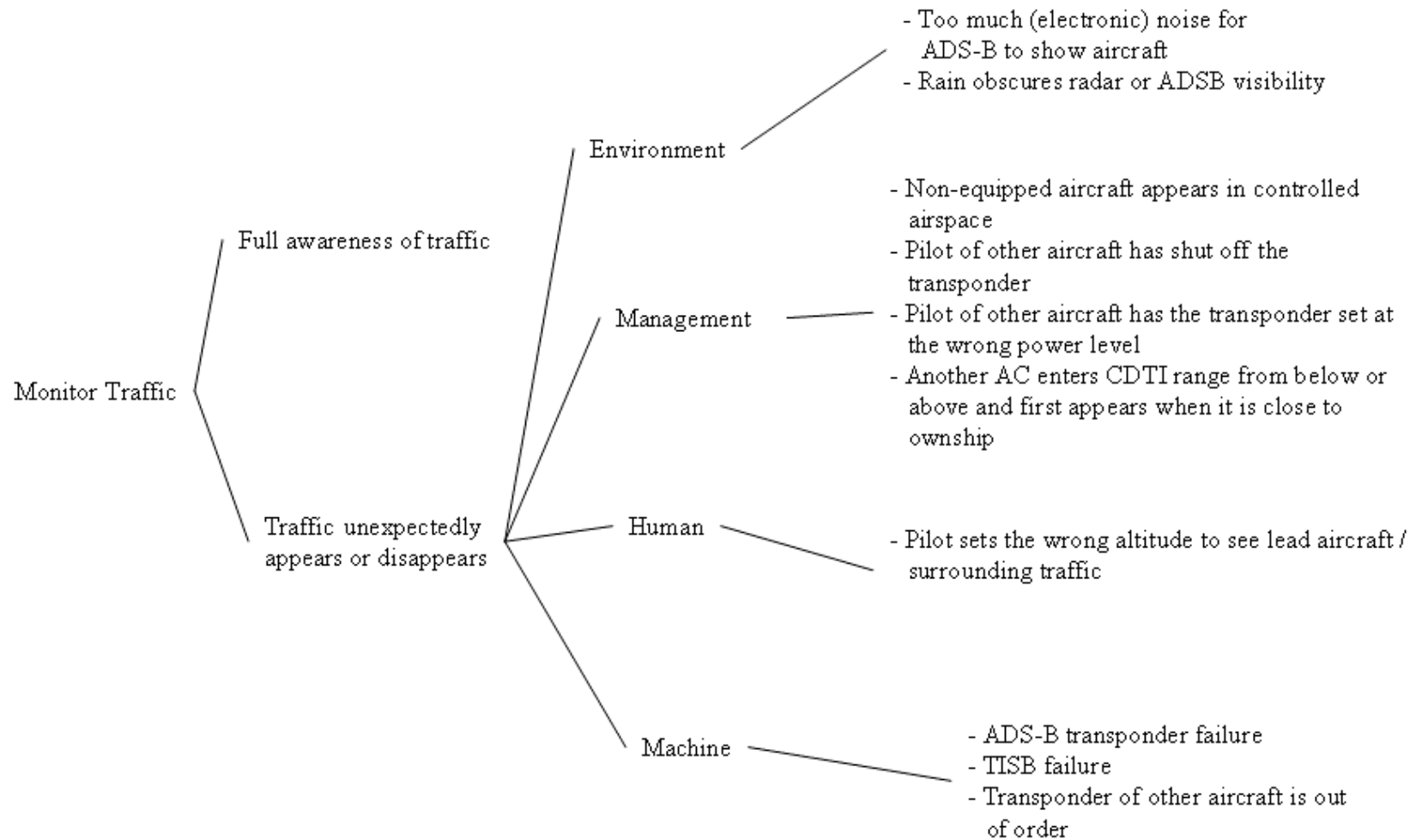

Figure 2.30. Murphy Diagram of NextGen Arrival / Approach Off-Nominal 7

APPROACH ON8

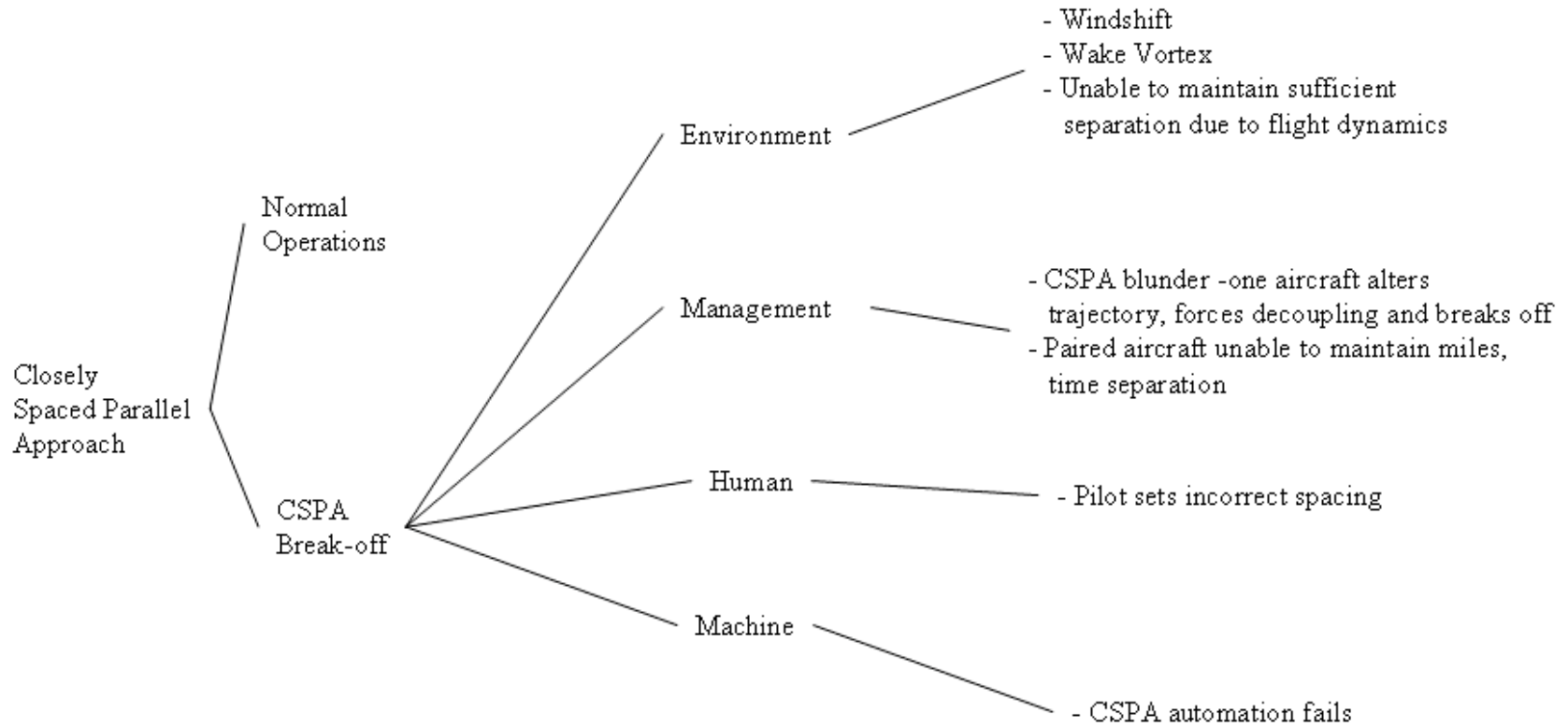

Figure 2.31. Murphy Diagram of NextGen Arrival / Approach Off-Nominal 8

APPROACH ON9

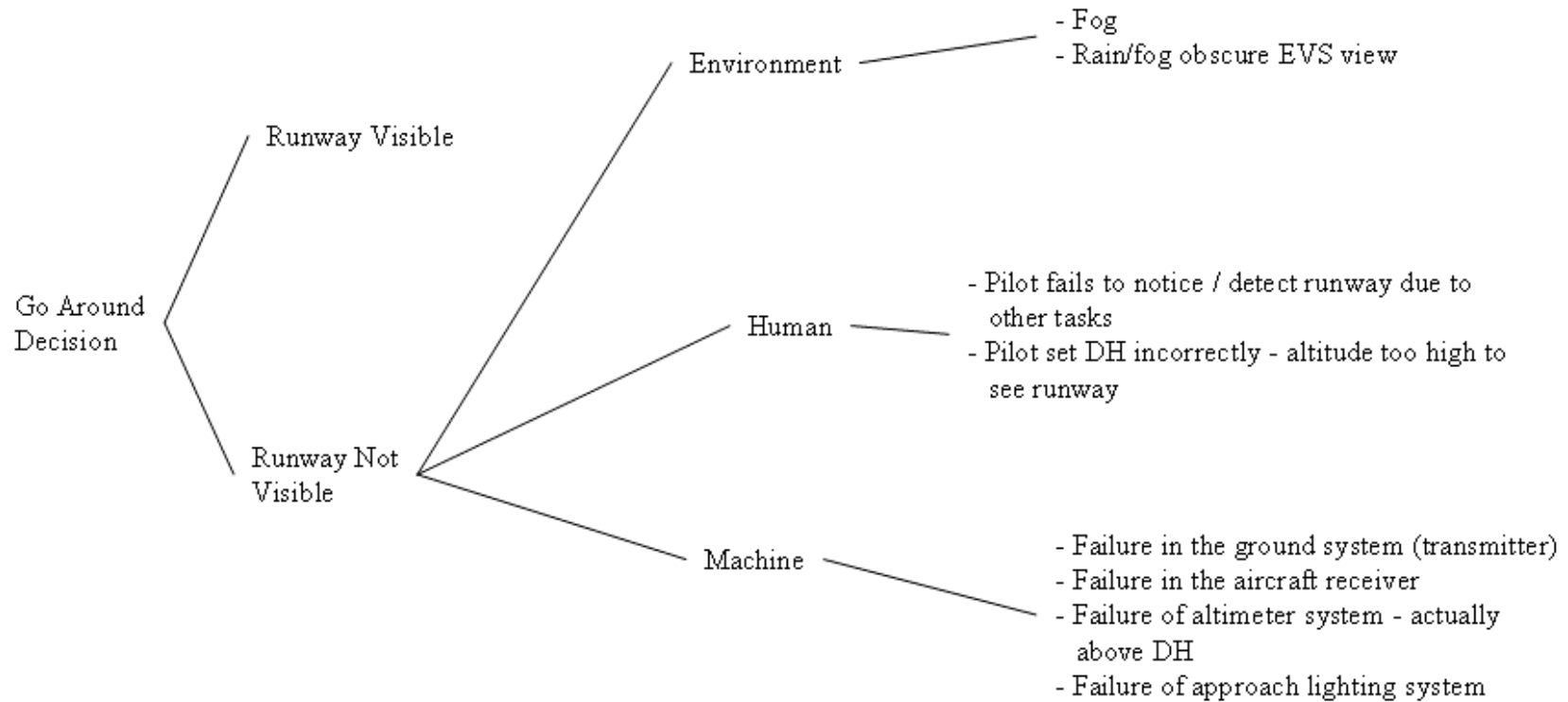

Figure 2.32. Murphy Diagram of NextGen Arrival / Approach Off-Nominal 9

APPROACH ON10

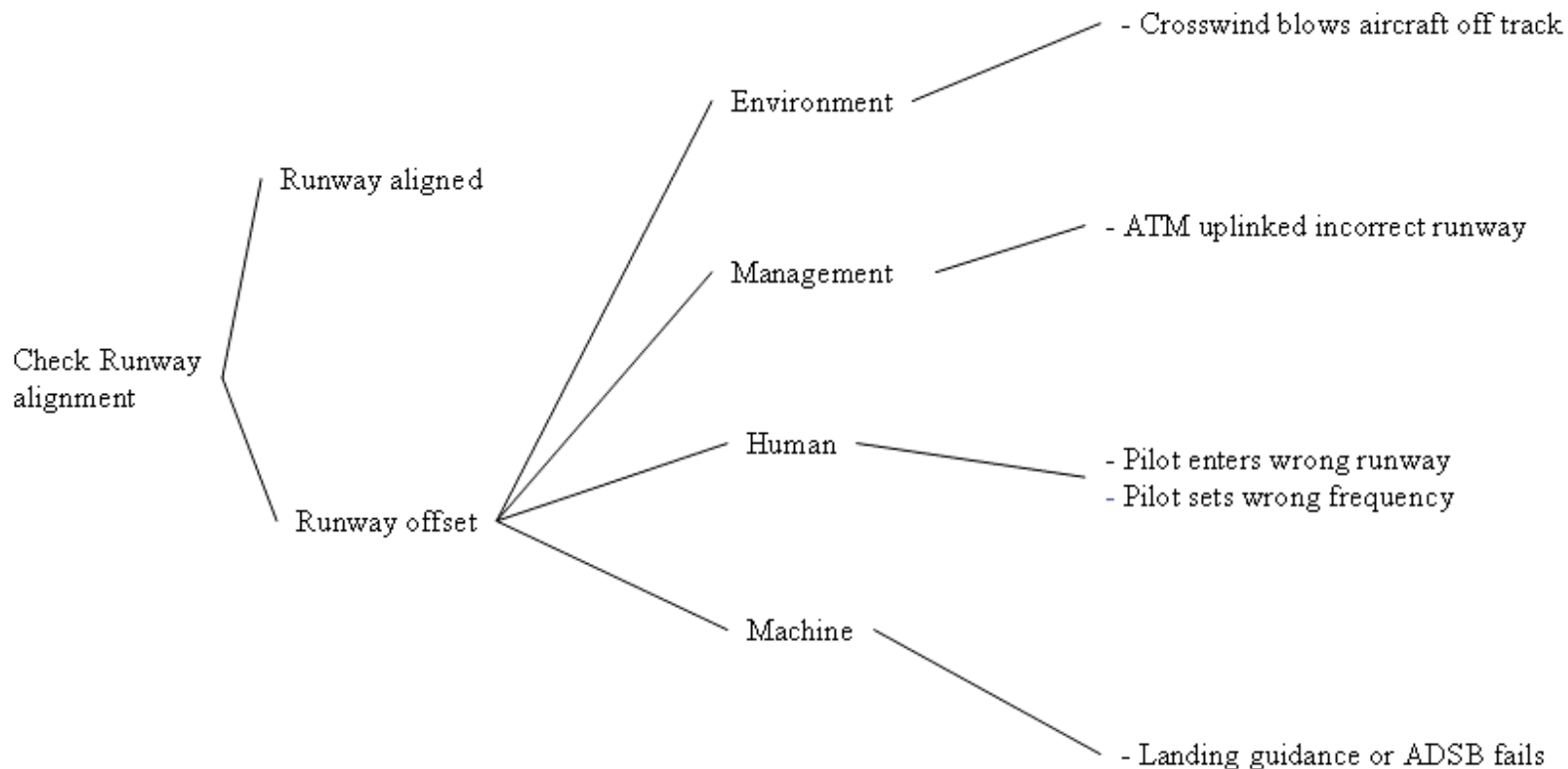

Figure 2.33. Murphy Diagram of NextGen Arrival / Approach Off-Nominal 10

APPROACH ON11

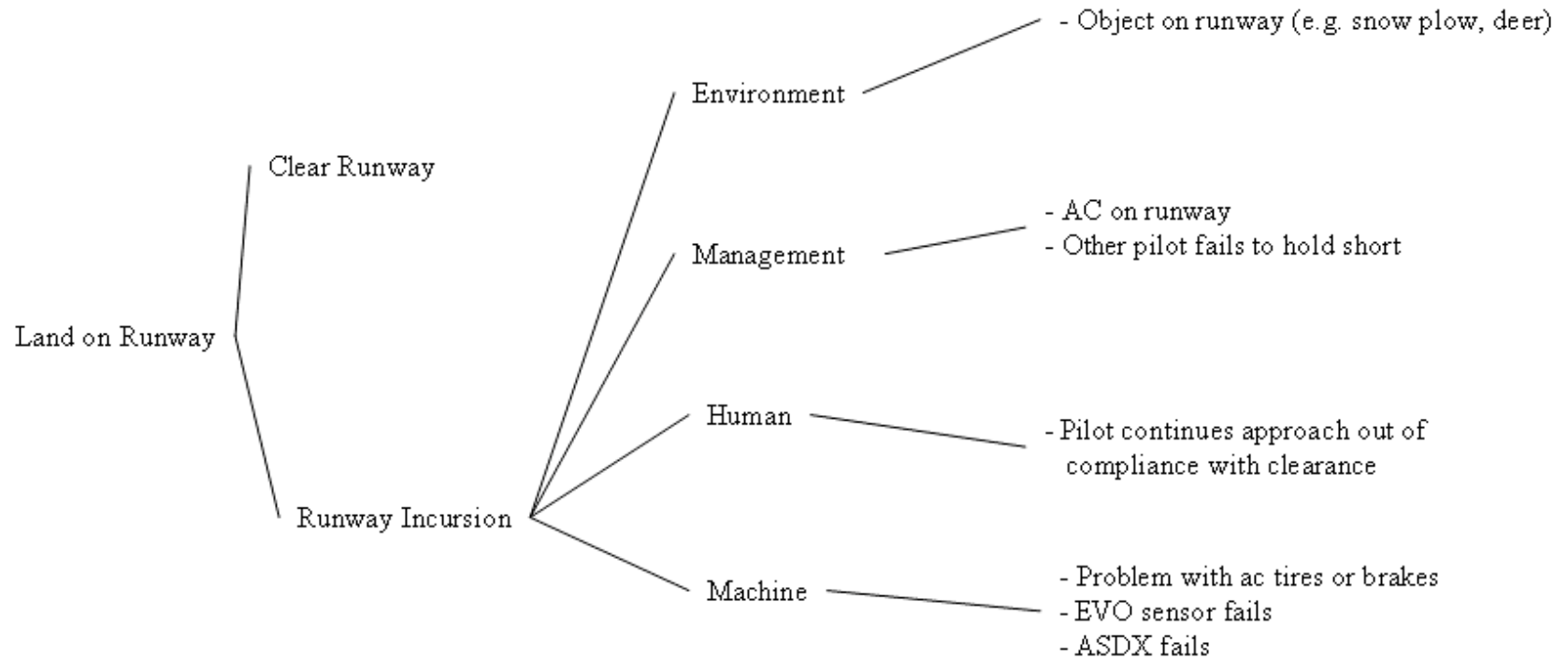

Figure 2.34. Murphy Diagram of NextGen Arrival / Approach Off-Nominal 11

APPROACH ON12

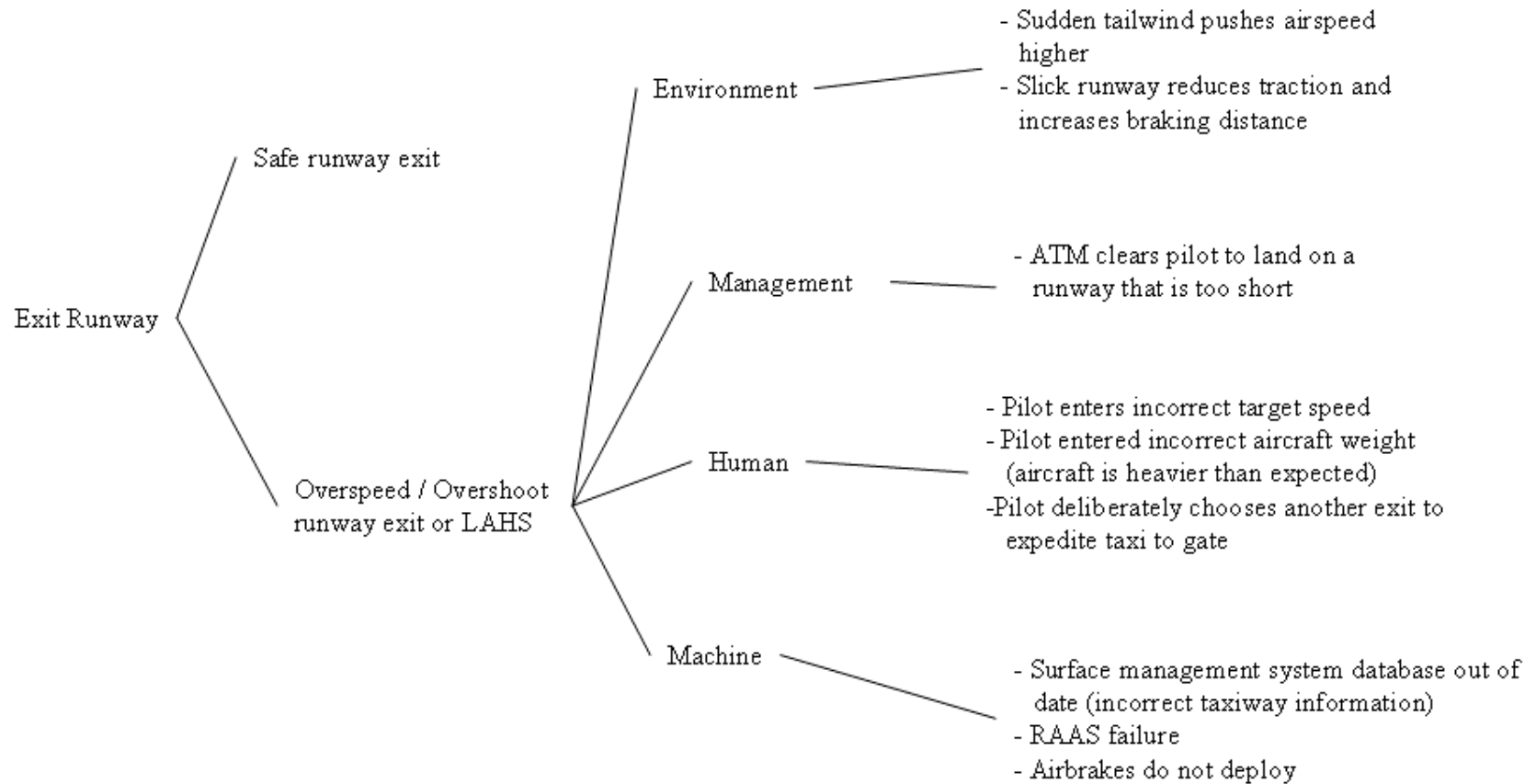

Figure 2.35. Murphy Diagram of NextGen Arrival / Approach Off-Nominal 12

APPROACH ON13

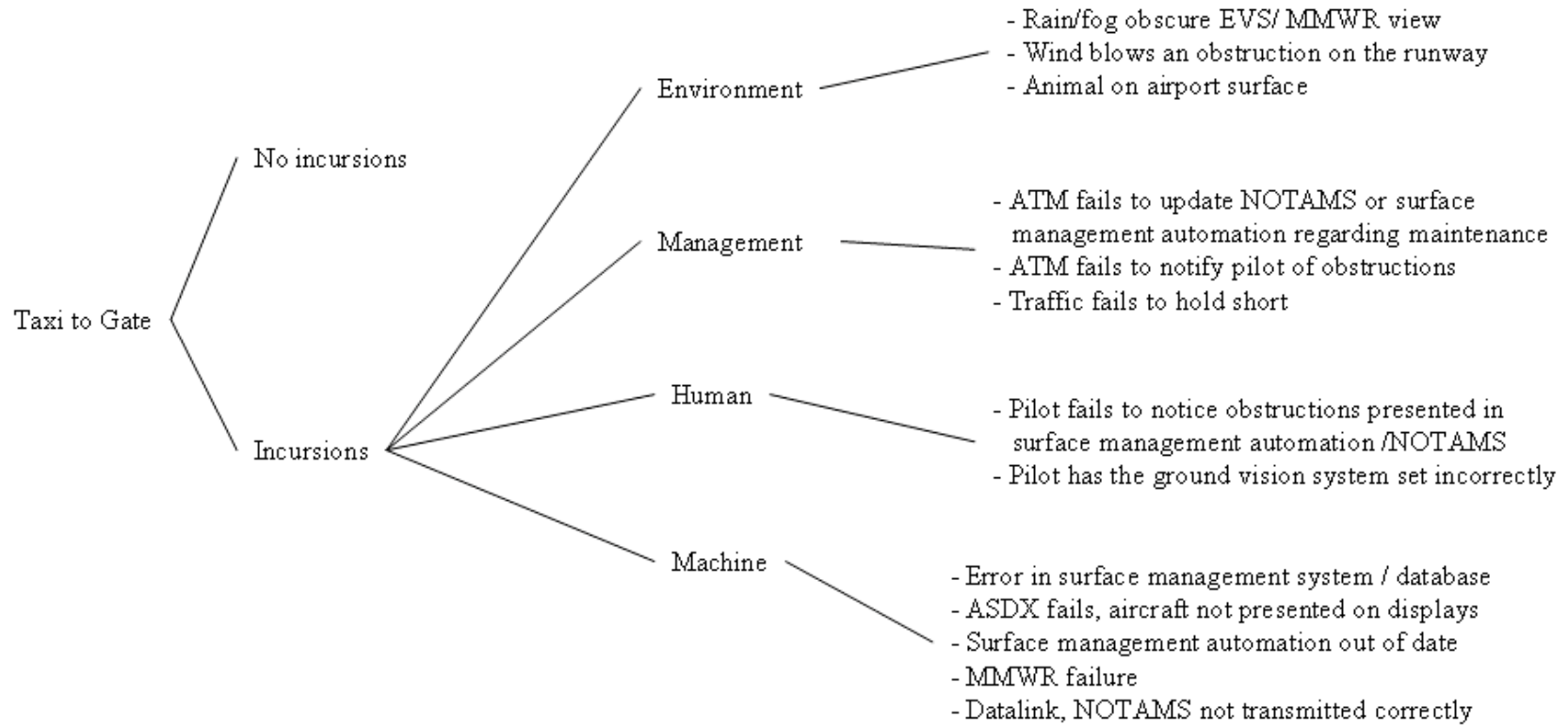

Figure 2.36. Murphy Diagram of NextGen Arrival / Approach Off-Nominal 13

2.6.3 Focus Group Results

Of the six pilots (five currently employed and one recently retired) who participated in the focus group, two were captains, and four were first officers. (One of the first officers also had experience as a captain). The pilots' age ranged from 39 to 60 (Mean = 47.5). The pilots' years of experience as a commercial pilot ranged from 14 to 33 (Mean = 25). The pilots had a range of experiences with advanced flight deck automation including datalink (6 pilots), FMS (6 pilots), head-up displays (2 pilots), terrain displays (5 pilots), and weather displays (6 pilots). Five of the six pilots reported previous experience conducting Tailored Arrivals. Five of the six pilots had experience flying very closely spaced parallel approaches in VFR conditions. See Appendix E for a more detailed summary of the pilot demographic information.

Pilots were asked to estimate the severity of impact of these off-nominal events on *safety* (see Table 2.1) and on *efficiency* (see Table 2.2) in NextGen. The ratings ranged from 1 to 7, with 1 being the least severe and 7 being most severe. These ratings were averaged across the six pilots, as shown in the tables below. The tables are color coded for rapid interpretation of the pilots' severity ratings. Ratings 5-7 (significant impact) are indicated with pink highlighting, 3-5 (moderate impact) are indicated with yellow, and 1-3 (minor impact) are indicated with green.

In terms of the perceived impact on safety, as Table 2.1 indicates, pilots were most concerned with those occurrences that could lead to a potential collision or loss of control (e.g., spacing violation, runway incursion). Data entry errors and being off the planned 4D trajectory were considered moderately important, and changes to trajectories and clearances were regarded as relatively minor occurrences.

Table 2.2 shows the pilots' estimates of the severity of impact on system *efficiency* for each off-nominal event. The same type of color-coding is used in this table. As this table shows, pilots provided "moderate" ratings for nearly all off-nominals. The few "severe" off-nominals are for issues that will clearly affect traffic flow, such as runway changes and emergencies. It was assumed that the pilots found it more difficult to predict the effects of off-nominals on efficiency in NextGen, so they tended to choose "middle of the road" values to describe most occurrences.

Note that throughout the meetings with NASA concept developers and the focus groups, six other off-nominal events were identified. These events were either not unique to NextGen operations or were not uniquely different from those already identified, and thus, are not presented here. However, they were rated by the pilots, and for completeness the full set is presented in Appendix H.

Table 2.1. Perceived Safety Impact for Off-Nominals in NextGen Arrivals / Approaches

| Off-nominal Event | Perceived Safety Impact | | | | | | Average | |
|---|--------------------------------|---|---|---|---|---|----------------|-----|
| | <i>Participant</i> | 1 | 2 | 3 | 4 | 5 | | 6 |
| | | | | | | | | |
| ON1: Data input error | | 5 | 6 | 2 | 7 | 3 | 3 | 4.3 |
| ON2: 4D Trajectory miss | | 3 | 4 | 2 | 4 | 4 | 4 | 3.5 |
| ON3: Required Navigation Performance compliance alert | | 2 | 3 | 5 | 2 | 3 | 3 | 3.0 |
| ON4: ATC uplinks a new trajectory | | 2 | 2 | 3 | 3 | 3 | 3 | 2.7 |
| ON5: Required runway change | | 2 | 2 | 2 | 4 | 3 | 4 | 2.8 |
| ON6: Wake Vortex alert | | 5 | 4 | 6 | 4 | 6 | 5 | 5.0 |
| ON7: Unexpected Traffic | | 5 | 5 | 6 | 5 | 6 | 5 | 5.3 |
| ON8: Very Closely spaced parallel approach violation | | 6 | 6 | 7 | 6 | 6 | 6 | 6.2 |
| ON9: Runway not visible below minimum | | 3 | 4 | 3 | 5 | 5 | 6 | 4.3 |
| ON10: Runway offset | | 5 | 4 | 7 | 6 | 2 | 7 | 5.2 |
| ON11: Runway incursion | | 6 | 7 | 7 | 7 | 6 | 6 | 6.5 |
| ON12: Overspeed at landing / overshoot exit | | 4 | 4 | 3 | 2 | 3 | 5 | 3.5 |
| ON13: Runway incursion during taxi | | 6 | 4 | 7 | 6 | 6 | 6 | 5.8 |

Table 2.2. Perceived Efficiency Impact for Off-Nominals in NextGen Arrivals / Approaches

| Off-nominal Event | Perceived Efficiency Impact | | | | | | Average | |
|--|------------------------------------|---|---|---|---|---|----------------|-----|
| | <i>Participant</i> | 1 | 2 | 3 | 4 | 5 | | 6 |
| | | | | | | | | |
| ON1: FMS data entry error | | 5 | 4 | 2 | 2 | 5 | 5 | 3.8 |
| ON2: 4D Trajectory miss | | 3 | 5 | 4 | 2 | 6 | 5 | 4.2 |
| ON3: RNP compliance alert | | 4 | 5 | 4 | 2 | 4 | 4 | 3.8 |
| ON4: ATC uplinks a new trajectory | | 2 | 3 | 5 | 3 | 5 | 4 | 3.7 |
| ON5: Required runway change | | 4 | 5 | 7 | 7 | 5 | 5 | 5.5 |
| ON6: Wake Vortex alert | | 4 | 4 | 5 | 4 | 4 | 3 | 4.0 |
| ON7: Unexpected Traffic | | 2 | 3 | 5 | 3 | 5 | 2 | 3.3 |
| ON8: Very Closely spaced parallel approach violation | | 3 | 6 | 4 | 4 | 4 | 2 | 3.8 |
| ON9: Runway not visible below minimum | | 3 | 6 | 6 | 4 | 4 | 2 | 4.2 |
| ON10: Runway offset | | 4 | 3 | 4 | 4 | 3 | 2 | 3.3 |
| ON11: Runway incursion | | 5 | 7 | 5 | 4 | 5 | 2 | 4.7 |
| ON12: Overspeed at landing / overshoot exit | | 5 | 4 | 5 | 3 | 4 | 2 | 3.8 |
| ON13: Runway incursion during taxi | | 3 | 3 | 5 | 2 | 5 | 2 | 3.3 |

2.7 NextGen Departure Scenarios

2.7.1 Nominal Departure

Figure 2.37 depicts a graphical view of NextGen departures. Similar to the notion of tailored arrivals (continuous descent), it is expected that ATC will upload departure paths that are tailored to

enable efficient continuous climb, without the need to level off or to follow current fixed navaids or standard departure paths. Our description of the NextGen departure (both nominal and off-nominal) is considerably less complex than for the arrival sequence for several reasons. Because aircraft are diverging after take-off, both airspace density (safety) and capacity are less serious issues, and hence need to be less the target of NextGen technology and procedures, than is the case when aircraft are converging on an airport. In addition, many of the nominal and off-nominal events, such as 4D contract negotiation, following the 4D trajectory, and monitoring RNP and the CDTI, are essentially similar to their description in the context of arrival / approach, and will not be repeated here.

However, three aspects of departure may substantially influence performance. First, because time pressure is less on the ground than in meeting a TOD “gate,” time-pressure (and turbulence induced) errors in accepting and loading a 4D contract will be less for departures than for arrivals. Second, wake vortex alerts may be **more** prevalent on departures, because the dynamics of the wake vortex causes it to drift downward from the generating aircraft, which here, unlike an arrival, will be more likely to cause it to penetrate the flight path of the following aircraft. Finally, this analysis includes events that, while unique to departure, are not unique to NextGen: events related to the rejected take-off. Future technologies and tools could help make rejected take offs even less frequent and less problematic than they are today (e.g., by eliminating pilot errors that result in rejected take-offs, and their impact on the departure stream). Automation has been considered a way to support this time- and safety-critical decision, and hence it could appear within a suite of future technologies.

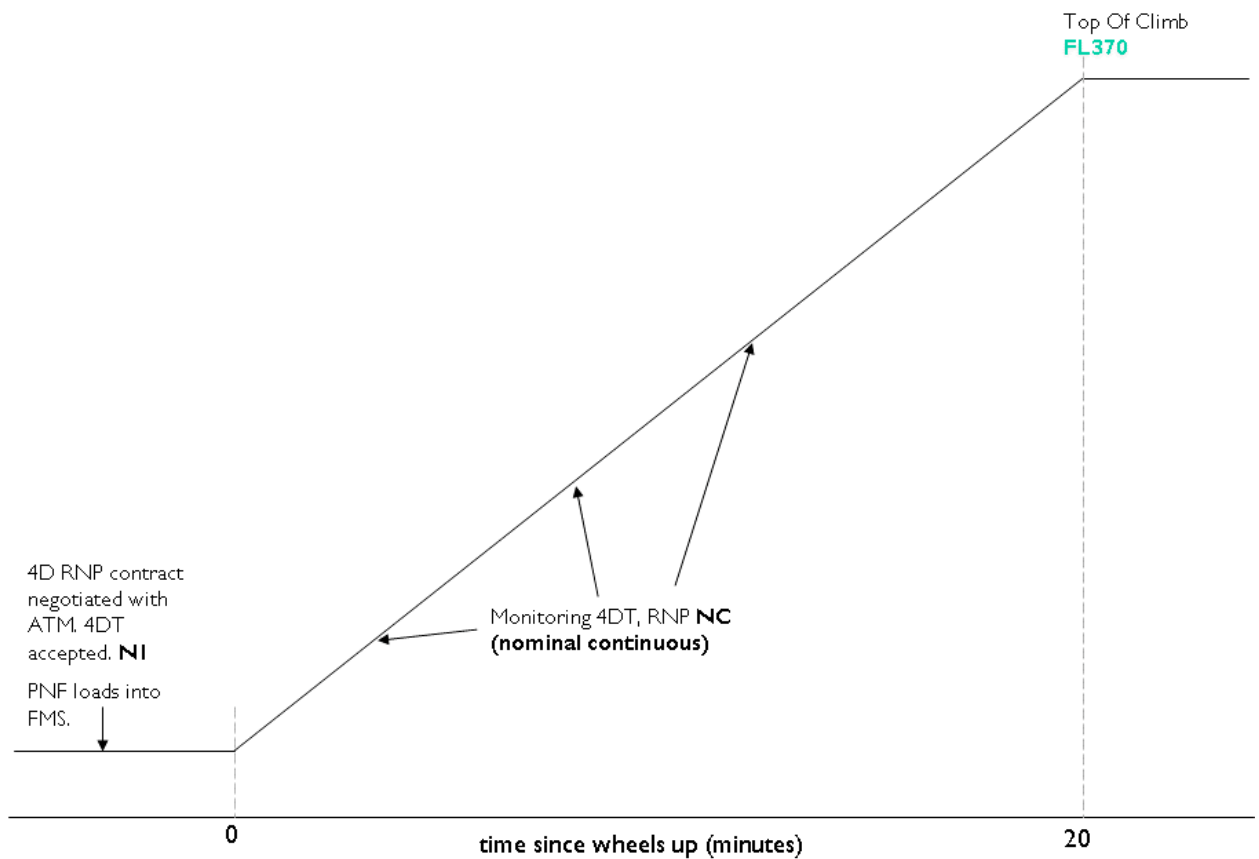

Figure 2.37. NextGen Nominal Departure

2.7.2 Off-Nominal Departure

Figure 2.38 represents an analogous presentation of our analysis, to that carried out for the arrival scenario. The off-nominal events are presented in red along with the nominal events presented in black. Similarly, modified Murphy Diagrams presented in Figures 2.39 through 2.46 below (and tables in Appendix G) are provided for each of the off-nominal conditions. In this section, however, we have not elaborated the narrative descriptions of the off-nominal events as they replicate those described in the approach section. While most of the off-nominal events are uniquely associated with NextGen technology and procedures, we have included rejected take-offs here because of their critical impact on super density operations.

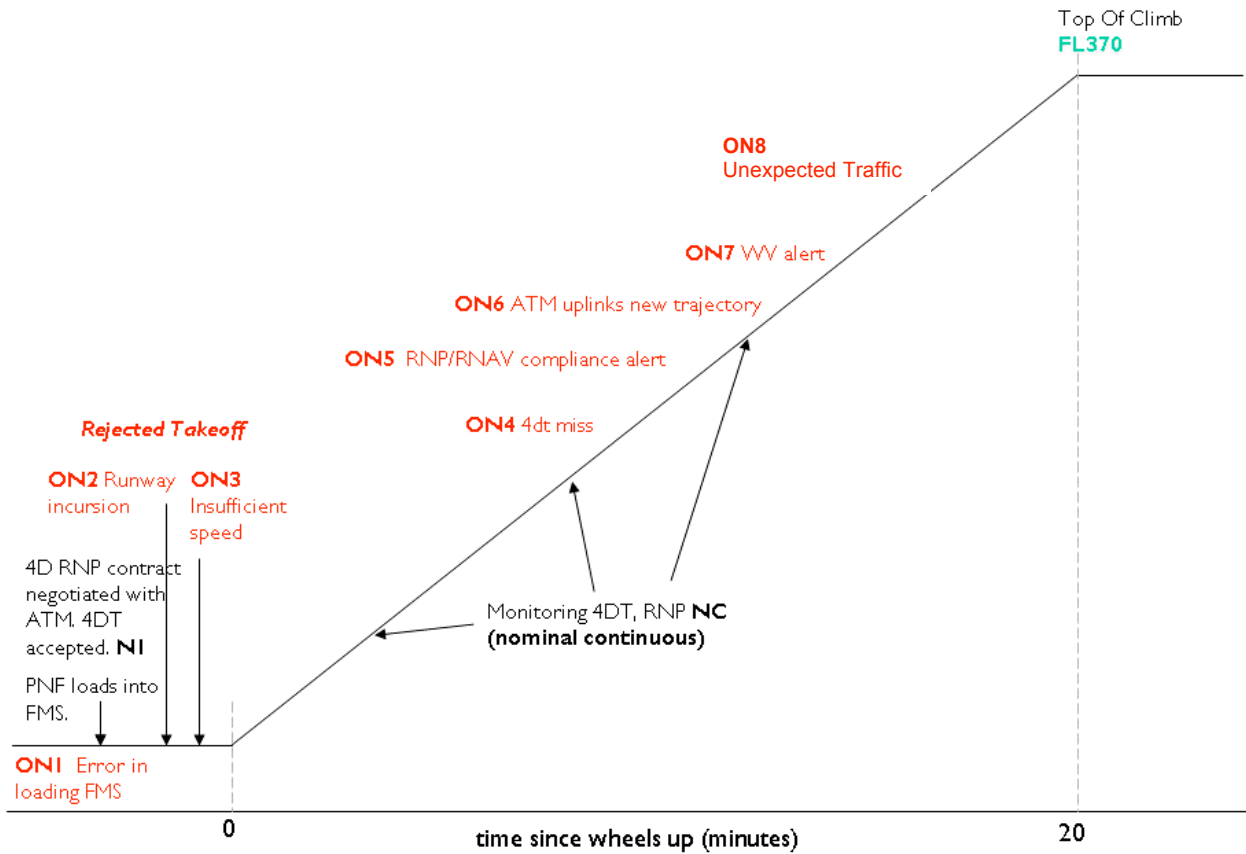

Figure 2.38. A NextGen Departure Scenario, with Nominal and Off-nominal Events

DEPARTURE ON1

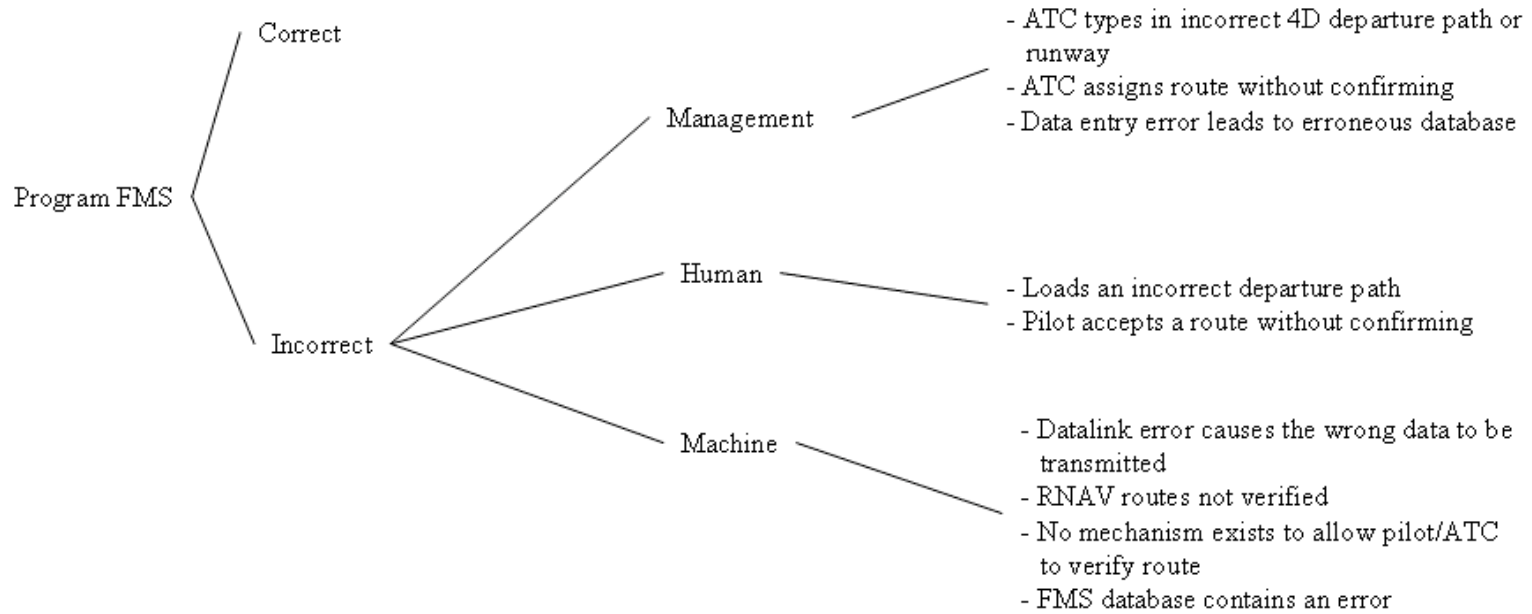

Figure 2.39. Murphy Diagram of NextGen Departure Off-Nominal 1

DEPARTURE ON 2

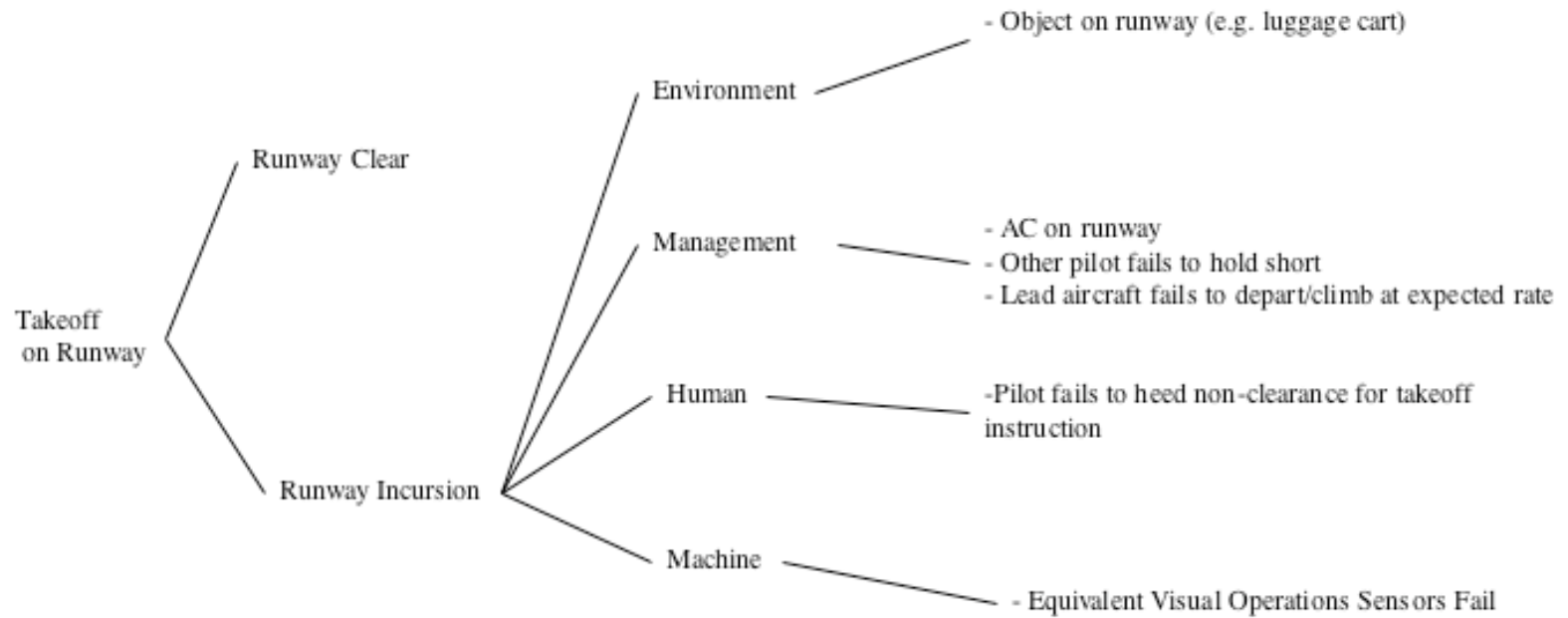

Figure 2.40. Murphy Diagram of NextGen Departure Off-Nominal 2

DEPARTURE ON 3

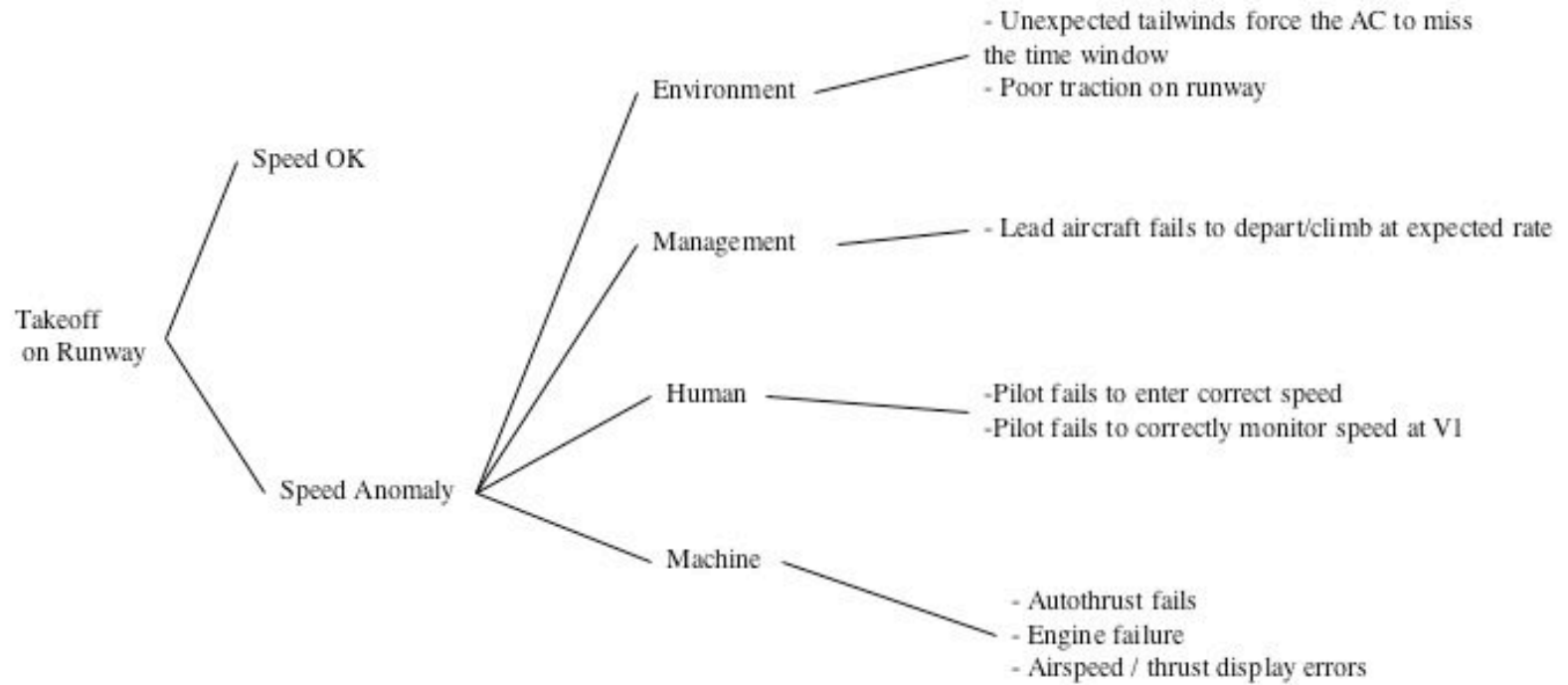
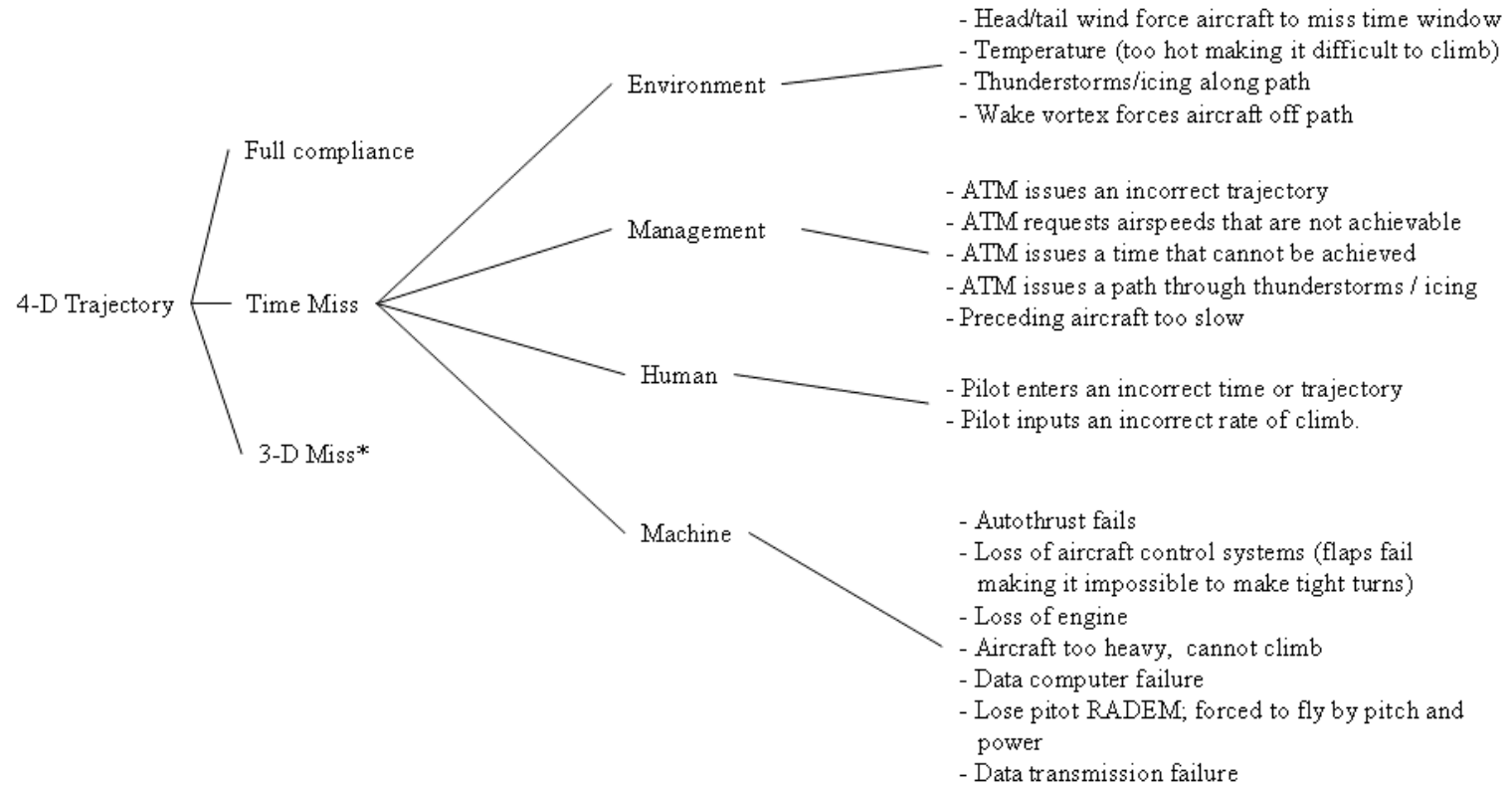

Figure 2.41. Murphy Diagram of NextGen Departure Off-Nominal 3

DEPARTURE ON4



*3D miss not addressed, as it is not unique to NextGen operations

Figure 2.42. Murphy Diagram of NextGen Departure Off-Nominal 4

DEPARTURE ON5

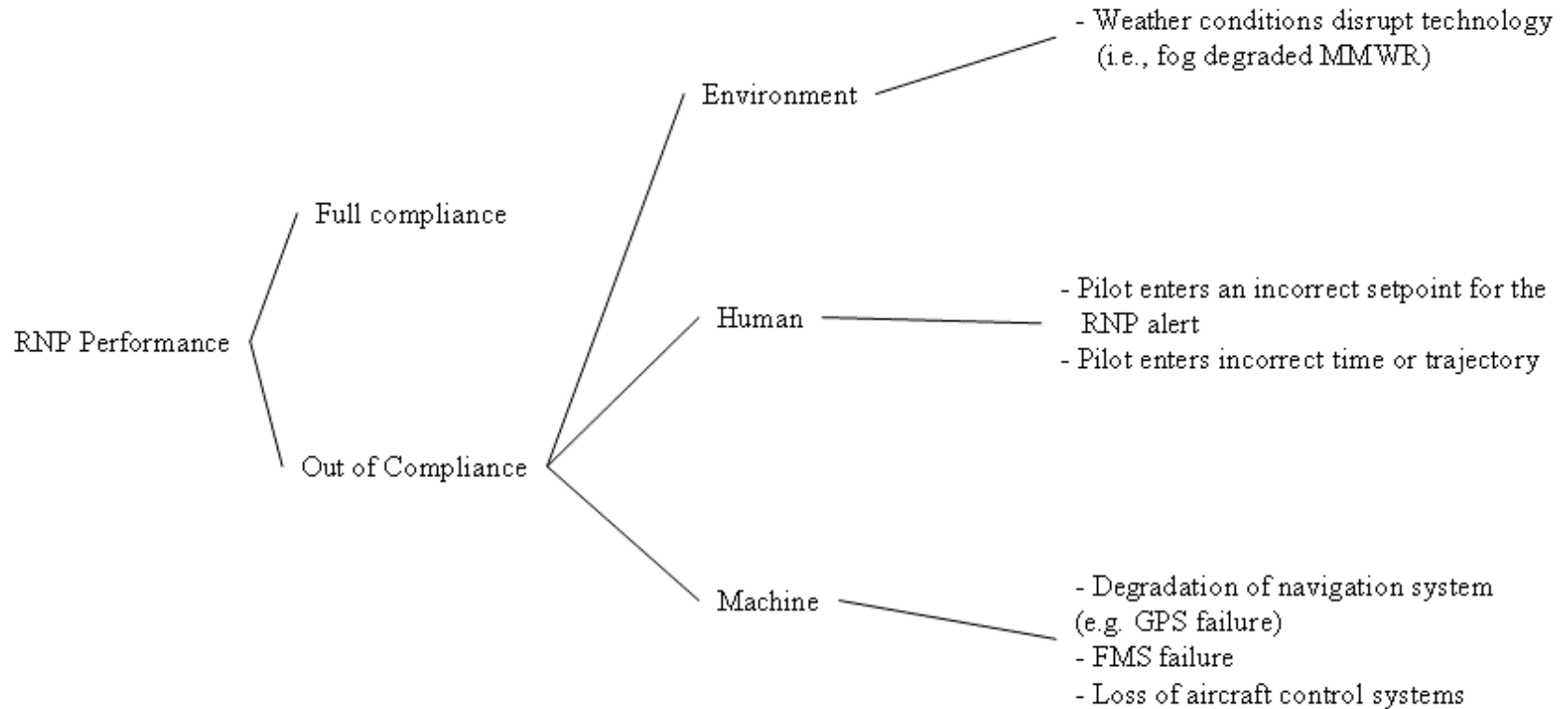

Figure 2.43. Murphy Diagram of NextGen Departure Off-Nominal 5

DEPARTURE ON6

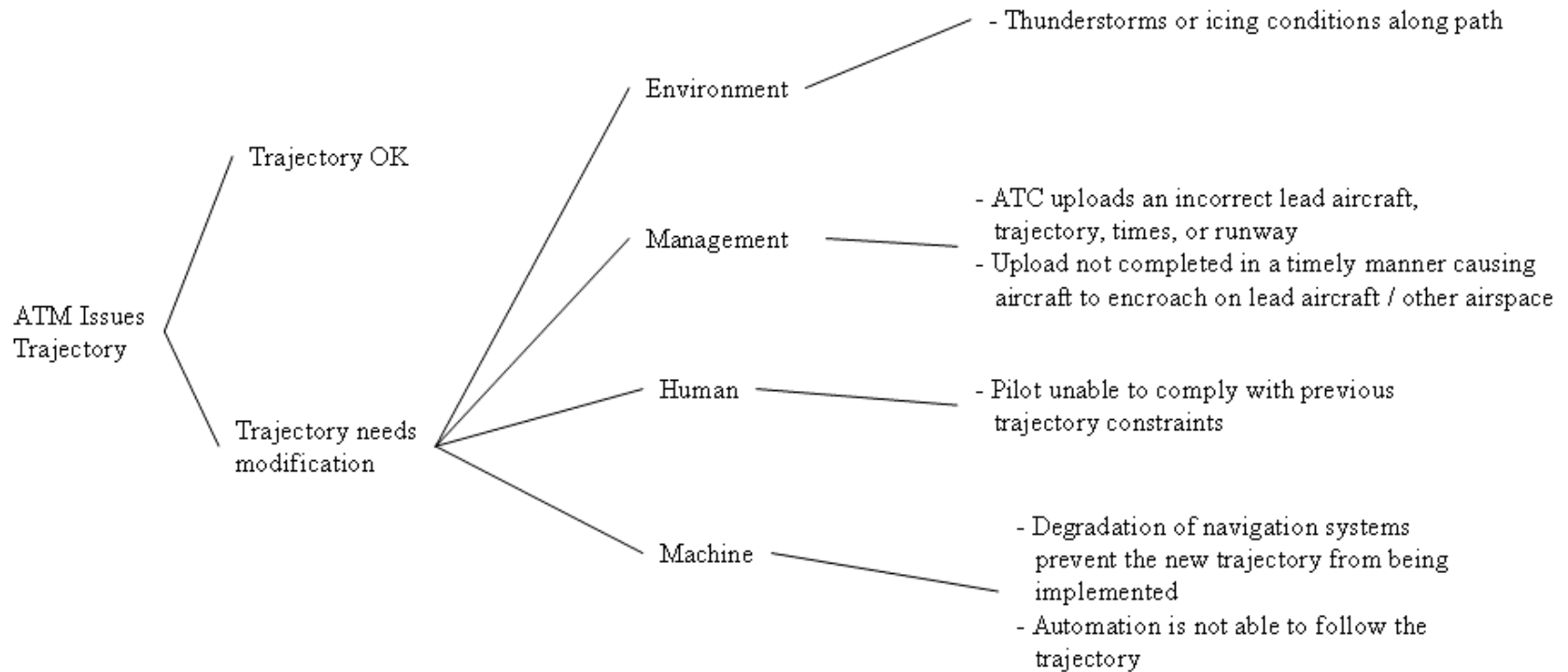

Figure 2.44. Murphy Diagram of NextGen Departure Off-Nominal 6

DEPARTURE ON7

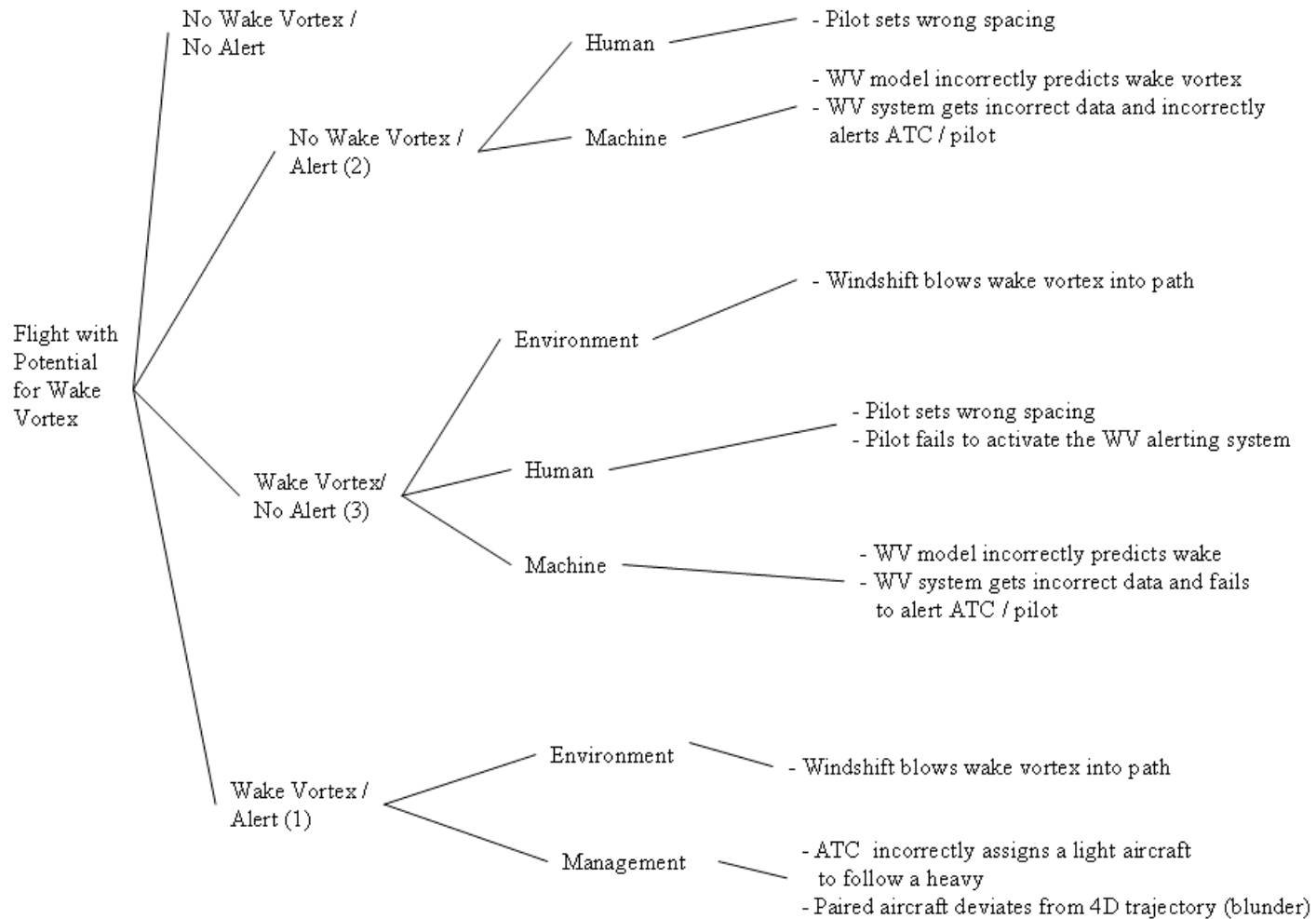

Figure 2.45. Murphy Diagram of NextGen Departure Off-Nominal 7

DEPARTURE ON8

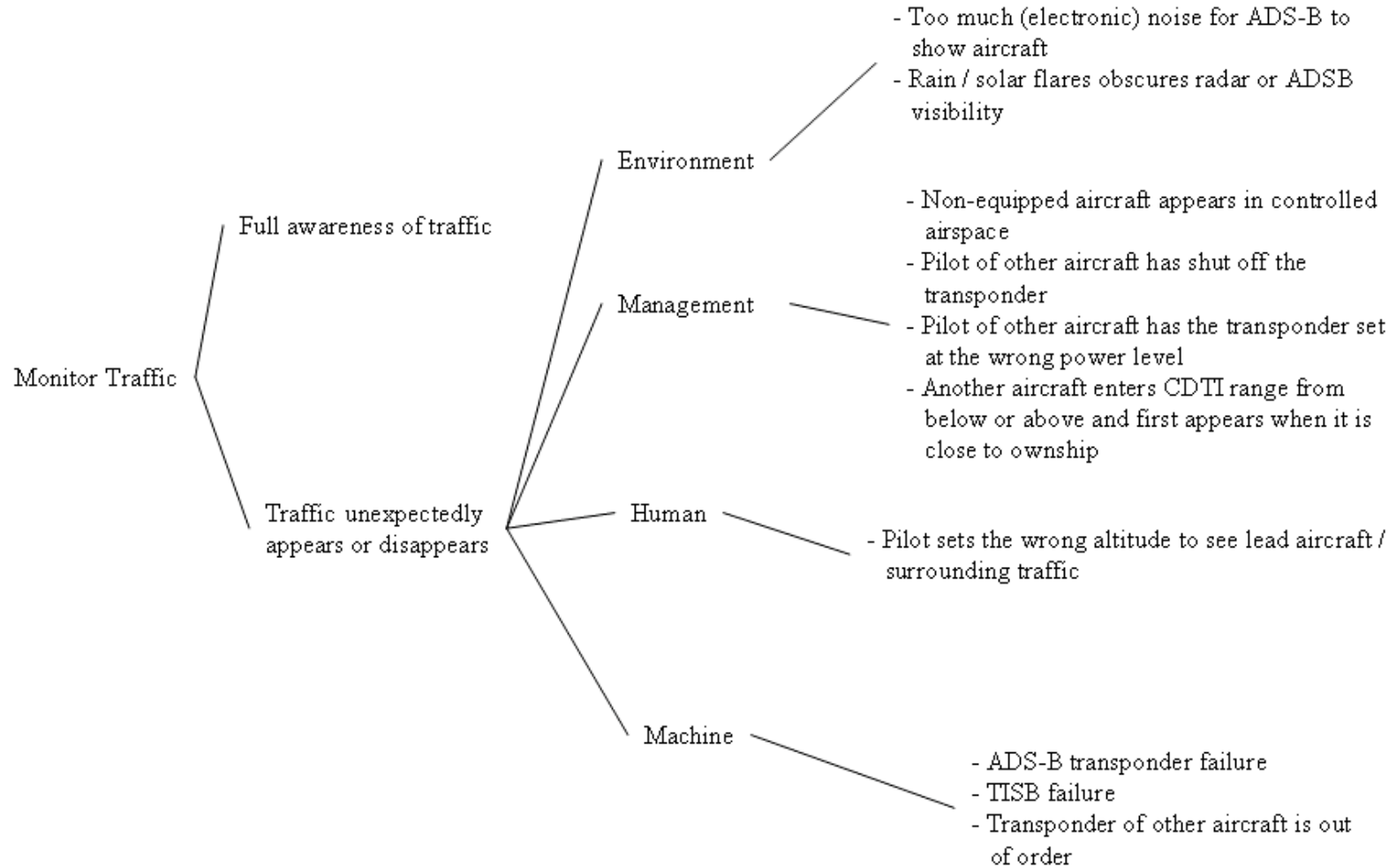

Figure 2.46. Murphy Diagram of NextGen Departure Off-Nominal 8

2.7.3 Focus Group Results

The following tables present the results of the pilot focus group discussions. Note that, as for approaches, additional off-nominals were identified by the pilots, but are not presented here as they were not NextGen specific; see Appendix H for a comprehensive list).

As Table 2.3 indicates, pilots’ estimates of the **safety** impact of the Departure off nominals were similar to their concerns for arrival / approach. They were most concerned with those occurrences that could lead to a potential collision or loss of control (e.g., route into terrain, popup traffic, aborted takeoff). Data entry errors were regarded as more severe on departure than arrival, perhaps because of discussions regarding a route into terrain. Being off the planned 4D trajectory was considered moderately important, and changes to trajectories and clearances were regarded as relatively minor occurrences.

Table 2.3. Perceived Safety Impact for Off-Nominal Events in NextGen Departures

| Off-nominal Event | Perceived Safety Impact | | | | | | Average | |
|-----------------------------------|--------------------------------|---|---|---|---|---|----------------|-----|
| | <i>Participant</i> | 1 | 2 | 3 | 4 | 5 | | 6 |
| ON1: Data entry error | | 7 | 6 | 3 | 7 | 4 | 6 | 5.5 |
| ON2: Runway incursion | | 5 | 5 | 6 | 7 | 5 | 6 | 5.7 |
| ON3: Speed Anomaly | | 4 | 5 | 6 | 5 | 5 | 6 | 5.2 |
| ON4: 4DT miss | | 2 | 4 | 3 | 4 | 2 | 5 | 3.3 |
| ON5: RNP Compliance alert | | 3 | 3 | 5 | 2 | 4 | 4 | 3.5 |
| ON6: ATM uploads a new trajectory | | 2 | 3 | 2 | 2 | 3 | 3 | 2.5 |
| ON7: Wake Vortex alert | | 5 | 4 | 6 | 5 | 5 | 6 | 5.2 |
| ON8: Unexpected traffic | | 6 | 5 | 6 | 5 | 5 | 6 | 5.5 |

Table 2.4 below shows the pilot ratings for perceived **efficiency** impact of off-nominal occurrences in NextGen Departures. As this table shows, and identical to the Arrival / Approach scenario, pilots provided “moderate” ratings for nearly all off-nominals. The one “severe” off-nominal (runway incursion) was an issue that will clearly affect traffic flow. Again, this was believed to be due to uncertainty about how off-nominals will impact efficiency in NextGen, rather than truly reflecting an “across the board” moderate impact.

Table 2.4. Perceived Efficiency Impact for Off-Nominal Events in NextGen Departures

| <i>Off nominal event</i> | <i>Perceived Efficiency Impact</i> | | | | | | <i>Average</i> | |
|-----------------------------------|------------------------------------|----------|----------|----------|----------|----------|----------------|----------|
| | <i>Participant</i> | <i>1</i> | <i>2</i> | <i>3</i> | <i>4</i> | <i>5</i> | | <i>6</i> |
| ON1: Data entry error | | 5 | 4 | 2 | 5 | 4 | 3 | 3.8 |
| ON2: Runway incursion | | 4 | 7 | 6 | 3 | 5 | 6 | 5.2 |
| ON3: Speed Anomaly | | 4 | 7 | 3 | 2 | 5 | 4 | 4.2 |
| ON4: 4DT miss | | 3 | 4 | 5 | 3 | 5 | 6 | 4.3 |
| ON5: RNP compliance alert | | 3 | 4 | 4 | 5 | 4 | 6 | 4.3 |
| ON6: ATM uploads a new trajectory | | 2 | 4 | 3 | 3 | 4 | 6 | 3.7 |
| ON7: Wake vortex alert | | 3 | 4 | 3 | 1 | 5 | 3 | 3.2 |
| ON8: Unexpected traffic | | 3 | 4 | 4 | 3 | 4 | 3 | 3.5 |

2.8 Summary and Conclusions

This research identified current-day operations in detail to provide an effective basis for human performance model development. Modeling current-day capabilities will be important to provide a baseline against which to compare NextGen concepts to ensure that they do indeed increase system efficiency without reducing safety as measured by pilot performance, workload, and situation awareness.

This research also yielded typical NextGen arrival and departure scenarios at a higher level of detail. The validity of these scenarios has been established with both NASA researchers and commercial pilots generally familiar with NextGen concepts.

A plausible set of off-nominal events that could occur in NextGen operations and identified attributes related to their detectability (location), frequency, and criticality (safety and efficiency impact) was identified. By positioning these along a time line together with nominal operations for each phase of flight, the team offers insight into the concurrent task workload that is expected when the event occurs.

CHAPTER 3. PHASE 2: PARAMETER META-ANALYSIS OF OFF-NOMINAL HITL STUDIES

3.1 Introduction

As reported in Phase 1 of this project, the next generation of the National Airspace System (NextGen; JPDO, 2007) is expected to require new technology to enable operations such as flexible 4D trajectories, very closely spaced parallel approaches, reduced aircraft wake vortex separation standards, equivalent visual operations, precision spacing and merging, and tightly-coordinated taxi operations. Some of the flight deck technologies that are anticipated with the transition to the NextGen include the use of Head-up displays (HUDs), Highway-in-the-sky (HITS) displays, datalink, and graphical routing information. To ensure that these new technologies and operations are robust to system perturbations (Burian, 2008), it is important to ensure that they support pilot performance in both nominal and off-nominal conditions. Off-nominal conditions may range from ‘less-likely but necessary’ operations that are slightly outside the range of normal operations (such as conflict alerts and unpredicted weather events), to very rare events (such as aircraft trajectory blunders and equipment failures). An inappropriate response to an off-nominal event can lead to a cascading effect in the system and disrupt the entire airspace flow. Therefore, a challenge facing the aviation research community is the need to predict pilot performance in the face of off-nominal events.

Due to the unexpected nature of off-nominal events, the opportunities to collect pilot response data in human-in-the-loop (HITL) simulations are often limited to one data point per subject, which both limits the ability to draw valid conclusions and to generalize the findings to other events and scenarios (Wickens, 2001). Human Performance Models are research tools that have been used to evaluate pilot performance under nominal conditions and are often cited as a solution to examine off-nominal scenarios (see Foyle & Hooey, 2008). To date, however, models of off-nominal or unexpected scenarios are limited because insufficient data exist to characterize performance and populate the models. The use of reliable and valid data sources to populate human performance models (HPMs) is critical to the success of any modeling effort. This phase of the research effort aimed to extract and extrapolate data from existing human-in-the-loop studies to inform the development of HPMs of Airspace Super Density Operations scenarios. The goal was to develop a comprehensive dataset that characterizes pilot performance during off-nominal events.

The scope of this research was limited to off-nominal events with clear, unambiguous, onsets and clearly defined responses. We assert that human responses to these types of off-nominal events are human performance primitives that transcend across phases of flight and pilot tasks, and thus are inherently well suited for inclusion as inputs for HPMs. At the same time, we acknowledge, that this is a limited set of off-nominal events and excludes other important types of events that involve multiple conflicting cues, or those which require lengthy diagnostic procedures to identify a problem and response. While this latter category is certainly important for NextGen aviation operations, it was beyond the scope of the present research effort. Our approach was to conduct a *parameter meta-analysis* across diverse HITL datasets that included off-nominal events. A meta-analysis is a statistical technique that combines the results of several studies that address a set of related research

hypotheses in an attempt to overcome the problem of reduced statistical power in studies with small sample sizes. This technique compensates for one known limitation of most HITL off-nominal studies – namely that HITL studies are often limited to one data point per human subject, because to include more than one eliminates the unexpectancy that is the very essence of an “off-nominal response” (see Foyle & Hooey, 2003). We use the term ‘parameter meta-analysis’, because unlike a formal meta-analysis that averages *effect-sizes* across studies, our effort will average ASDO-relevant quantitative human performance parameters – specifically means and frequencies of off-nominal *event detection latency and accuracy*. These measures were characterized along a taxonomy of relevant ASDO characteristics.

This parameter meta-analysis is expected to characterize how noticing probability (P(Notice)) and noticing time (NT) are influenced by important variables such as pilot expectancy and event location, and how these expectancy-location functions are modulated by the presence of flight deck technologies such as head-up displays (HUDs), highway-in-the-sky (HITS) displays, datalink, and graphical route displays. The advantage of this parameter meta-analysis approach is that it produces estimates of the cost or benefit of each factor on response latency and accuracy rather than simply summarizing average latency for each particular off-nominal event. This method has previously been used to evaluate SVS (Synthetic Vision System) displays (Wickens, 2005), as well as to analyze human response to imperfect diagnostic automation (Wickens & Dixon, 2007).

There are two specific goals of this phase of the research effort:

- 1) Produce human performance parameters that characterize the probability of noticing an event and the latency associated with responding to an event.
- 2) Generate a dataset that can be used in the subsequent phase of research to validate a model that predicts P(miss) and response latency for future NextGen scenarios.

3.2 Method

3.2.1 Selection Criteria

A comprehensive review of the literature was undertaken to search for studies that included off-nominal scenarios. In addition to global database searches and personal contact with relevant researchers in the field, the following periodicals were systematically reviewed by the research team:

- Annual Conference on Manual Control (1965-1984)
- Digital Avionics System Conference (1990 -2007)
- IEEE Transactions of Systems, Man, Cybernetics. Part A: Systems and Humans (1998 - 2004)
- IEEE Transactions of Systems, Man, Cybernetics. Part C: Applications and Reviews (1998 - 2004)
- International Journal of Aviation Psychology (1991, 1994, 1997-2007)
- International Symposium on Aviation Psychology (1981 - 1997)
- Human Factors Journal (1977 - 2007)
- NASA Technical Reports Server (1901 – 2008)

- Proceedings of the Human Factors and Ergonomic Society Annual Meeting (1973 - 2007)
- US-Europe Air Traffic Management R&D Seminar (<http://www.atmseminar.org/>) (1997 - 2007)

This search yielded over 80 HITL studies (See Appendix I for a list of all studies identified).

The scope of the literature was necessarily constrained to include papers that met the following criteria:

- The study was within the aviation domain, with an emphasis on pilot performance.
- The study was either a simulation or flight test with human pilots as subjects.
- Subjects had not received training regarding, or been cued to the possibility of, the off-nominal event.
- The off-nominal event was either truly surprising (i.e., one per subject) or very infrequent (e.g., one per condition).
- The off-nominal event had a clear, unambiguous onset (e.g., warning light onset, traffic on runway) and an objective, measurable response (e.g., button press, eye glance, or verbal response).
- The paper included sufficient detail to discern the method used and the performance data (either response/latency time or detection/miss rates or both).
- The paper was publicly available in the literature.

This process reduced the set of relevant HITL studies to 34 studies (see Appendix J) that met the specific criteria for inclusion in the analyses. The conclusions of those studies that were not included in the analyses are valuable in their own right for those wishing to understand off-nominal responses. However we found it difficult to pool their data with other data for certain reasons: for example their procedures were sufficiently different from the other studies as to cast doubt on whether they could be associated with the same class; in some cases, critical variables necessary for classification (e.g., event expectancy or location) were not specified in sufficient detail for us to be confident of the classification category; and in some cases, only miss rate data were reported when then relevant variable, for the current meta-analysis, was latency.

The articles that were selected for inclusions were then summarized on the following dimensions:

- Subjects (number, type, experience)
- Task (phase of flight, study goals, technology studied, test environment)
- Off-nominal event description
- Off-nominal event expectancy / frequency
- Results including response time and event detection rates

A synthesis of these studies revealed two general classes of events: Event Onset Detection events, in which the pilot had to respond to an object such as traffic or terrain in the world, or an alert or warning in the cockpit; and Error Detection events, in which the pilots received information which contained an error, such as an ATC clearance, and pilots typically had to consult either his/her own

memory or another source of information within the cockpit to detect if the information was correct or incorrect. Both error types were included in these analyses.

3.2.2 Technical Approach to Analyses

Two dependent variables were examined in the following analyses: 1) Miss-rate, or the number of pilots that failed to respond to the event divided by the number of pilots that experienced each event⁴ and 2) Response latency, or time from event onset to the required response to acknowledge response, as defined by the experimenter. As will be seen, much more miss-rate data exist than response latency data, and most studies provided one or the other measure, but not both.

Analyses were conducted by pooling⁵ the event detection miss rate for common conditions across studies and weighting the studies by their sample size. For example, if two studies in one condition had miss rates of 1/5 and 30/50, a single proportion for the studies of 31/55 was extracted. Note that this mean proportion is far closer to the 0.60 value of the second study, than the 0.2 value of the first – but using this weighted approach, the resulting value more closely reflects the proportion of the larger sample size than if both studies had been given equal weighting. Chi-squared tests were used to assess if the relative frequency count of missed vs. non-missed events was statistically equivalent across the level of another variable. Subsequently, where appropriate, further chi-square tests were conducted to determine whether a difference observed might be modulated by a second factor. The modifications may occur when levels of another factor exert very different effects (i.e., a classic two-way interaction), and this modulation can be amplified if the *N* of the different studies contributing to the other factor is very different at its two levels. We adopt a liberal alpha level of 0.1 for all analyses as we believe that for this exploratory meta-analysis, and given the relatively small number of studies available, this is an appropriate tradeoff of Type I and Type II errors.

3.3 Results – Miss Rate Analyses

There were a total of 26 HITL studies with valid miss rate data. An analysis of the probability of a pilot failing to respond to the off-nominal event (that comprises the miss rate data), pooled across all available studies and event types, revealed an **overall miss rate of 0.32**, a value that is noteworthy for its magnitude above zero. All studies included in our analyses contained a positive indication of the off-nominal event, that is, the events were clearly visible, and hence certainly could be detected if they were expected and attention focused toward their location. Even in these “positively-

⁴ In calculating miss rate, on occasion, if there was more than one event per pilot, and the data did not specify the miss rate for the first event, miss rate was calculated as the number of events missed divided by the total number of events.

⁵ Our initial approach was to extract a miss rate from each study/condition, and treat this miss-rate as single raw data points which were subjected to an Analysis of Variance (ANOVA). One problem with this approach was that we were treating as equivalent (e.g., 1 data point) studies with a high sample size (and hence a reliable estimate of miss rate) and those with a very low sample size (e.g., *N* = 4; an unreliable estimate). As a consequence, the high variability of the latter (low *N*) points often contributed a great deal of variance to the data, sometimes creating highly non-normal distributions that grossly violated ANOVA assumptions. Although we avoided some of these violations by using non-parametric tests, these tests lacked a great deal of statistical power. A second problem with this approach is that certain cells that were to be compared were populated only by 1 or 2 studies, thus creating a very low sample size, which further constrained statistical power. The chi-square approach that we adopted using pooled miss rates increased the sample size, (the denominator) and hence statistical power relative to the ANOVA approach.

indicated” studies, almost 1/3 of the off-nominal events were not detected. This detection rate was further examined as a function of: 1) off-nominal event characteristics and 2) flight deck technology characteristics.

3.3.1 Off-Nominal Event Characteristics: Phase of Flight, Expectancy and Event Location

Three characteristics of the off-nominal events were evaluated: Phase of flight, event expectancy, and event location. These main effects, and interactions among them, are described below along with tables that present the chi-square and the associated miss rates. The fraction shows the total number of misses / the total number of subjects in that condition. The number in parentheses is the decimal form of that same fraction. Event characteristics that were also moderated by the absence or presence of flight deck technologies will be described in the following section.

Phase of Flight. An analysis of miss rate (that is, the rate that pilots failed to detect an off-nominal event) revealed that across all 26 studies in our analysis, the probability of missing an off-nominal event was highest during departures ($p_{miss} = .50$), followed by cruise ($p_{miss}=.47$), arrival/approach ($p_{miss} = .39$), and taxi ($p_{miss} = .20$; $\chi^2 (3) = 34.61, p < .001$; see Table 3.1). The reader is cautioned in interpreting the departure miss rate, however, as this was comprised of only one study with eight pilots. These miss rates may reflect an expectancy effect as pilots tend to be more vigilant and aware of both the traffic environment and their aircraft status during the arrival and taxi phases than in the cruise and departure phases. They may also reflect a location effect as events during cruise tended to be located on the instrument panel, but during approach the event tended to be out-the-window (OW). These effects will be discussed next.

Table 3.1. Phase of Flight Main Effect

| Departure | Phase of Flight | | | χ^2 | p< |
|-----------------|--------------------|---------------------|-------------------|----------|------|
| | Cruise | Arrival | Taxi | | |
| 4 / 8 (0.50) | 56 / 119 (0.47) | 110 / 281 (0.39) | 50 / 248 (.20) | 34.61 | .001 |

Expectancy. The effect of expectancy on pilot detection of off-nominal events was assessed by comparing the miss rate from the *first off-nominal event* a pilot experienced to that from all subsequent off-nominal events (see Table 3.2). As would be expected, the probability of missing the event was higher if it was the first event ($p_{miss} = 0.48$) than for subsequent off-nominal events ($p_{miss} = 0.29$; $\chi^2 (1) = 24.70 p < 0.001$). This produced an **Unexpectancy Cost of 0.19**.

Table 3.2. Event Expectancy Main Effect

| Event Expectancy | | χ^2 | p< |
|------------------|------------------|----------|------|
| First Event | Not First Event | | |
| 94 / 195 (0.48) | 181 / 625 (0.29) | 24.70 | .001 |

Event Location. Next, the off-nominal events across all available studies were classified as occurring either OW or head-down in the cockpit. The probability of missing an event was lower when it was OW ($p_{\text{miss}} = 0.29$) than when it was head down ($p_{\text{miss}} = 0.39$), $\chi^2(1) = 9.88$, $p < 0.01$, yielding a **Cockpit Location Cost of 0.10** (Table 3.3).

Table 3.3. Event Location Main Effect

| Event Location | | χ^2 | $p <$ |
|----------------|------------------|----------|-------|
| OW | Head Down | | |
| 195/677 (0.29) | 103 / 261 (0.39) | 9.88 | 0.01 |

Expectancy X Event Location Interaction. The analysis also yielded an interaction between event expectancy and location (see Table 3.4). There was a large unexpectancy cost when the off-nominal event was OW (p_{miss} for first OW event = 0.50; p_{miss} for subsequent OW events = 0.23; $\chi^2(1) = 39.86$, $p < 0.01$; **OW Unexpectancy Cost of 0.27**) but when the off-nominal event was within the cockpit, there was no difference in miss rate as a function of expectancy ($p_{\text{miss}} = 0.41$ for both). This could reflect that pilots bring their own knowledge of real-world expectancies to the HITL study since in actual operations the frequency, and therefore expectancy, of a head-down event is much greater than for OW events. In other words, in the simulations, the first cockpit event, was not as truly surprising as the first OW event.

Table 3.4. Event Expectancy by Event Location Interaction

| Expectancy | Event Location | | χ^2 | $p <$ |
|-----------------|-----------------|-----------------|----------|-------|
| | OW | Cockpit | | |
| First Event | 80 / 161 (0.50) | 14 / 34 (0.41) | 0.82 | >.1 |
| Not First Event | 92 / 406 (0.23) | 89 / 219 (0.41) | 22.35 | .001 |
| χ^2 | 39.86 | .004 | | |
| $p <$ | 0.001 | >.1 | | |

3.3.2 Flight Deck Technology Factors

The analyses of pilots’ event detection as a function of the presence of various advanced flight deck technologies was driven in a bottom-up fashion by considering the range of technologies studied in the available literature. The flight deck technologies included in these analyses include head-up displays (HUDs), highway-in-the-sky (HITS) displays, datalink, and graphical route displays. The effects of these technologies, and relevant interactions, are presented next with tables of the miss rates and chi-square analyses.

Head-Up Display (HUD). HUDs are used in current operations for approach and landing, and may be used in NextGen for surface operations and to support low-visibility operations. An analysis using six HITL studies evaluated whether the presence of a HUD affected the probability of detecting an off-nominal event (regardless of event location). The probability of missing an event was higher when the pilots were flying with a HUD ($p_{\text{miss}} = 0.39$) than without ($p_{\text{miss}} = 0.31$), $\chi^2(1) = 4.13$, $p < .05$. This produced a **HUD Cost of 0.08**.

Table 3.5. HUD Use Main Effect

| Presence of HUD in Cockpit | | χ^2 | $p <$ |
|----------------------------|------------------|----------|-------|
| HUD | No HUD | | |
| 66 / 169 (0.39) | 202 / 655 (0.31) | 4.13 | .05 |

Next, this HUD effect was examined to determine the extent to which it was moderated by Event Expectancy. As can be seen in Table 3.6, there was no significant HUD Effect for the first, truly surprising events (p_{miss} with HUD = 0.37; p_{miss} without HUD = 0.48; $\chi^2(1) = 1.87$, $p = .17$; **non-significant HUD benefit = 0.11**). However, for the subsequent, somewhat surprising events, the miss rate was higher when flying with a HUD ($p_{\text{miss}} = 0.40$), than when flying without a HUD ($p_{\text{miss}} = 0.28$; $\chi^2(1) = 5.59$, $p < .05$; **HUD Cost for Subsequent Events = 0.12**).

Table 3.6. HUD Use X Event Expectancy Interaction

| Expectancy | Presence of HUD in Cockpit | | χ^2 | $P <$ |
|-----------------|----------------------------|------------------|----------|-------|
| | HUD | No HUD | | |
| First Event | 19 / 51 (0.37) | 64 / 132 (.48) | 1.87 | .17 |
| Not First Event | 47 / 118 (0.40) | 115 / 405 (0.28) | 5.59 | 0.05 |
| χ^2 | .1 | 18.08 | | |
| p | >.1 | 0.001 | | |

This HUD effect was modified by the location of the off-nominal event (Table 3.7) in a manner that reflects the classic Fischer, Haines, and Price (1980) finding that the HUD particularly obscures unexpected OW events (See also Fadden, Wickens, & Ververs, 1999). When the off-nominal event occurred OW, the probability of missing the event was greater when pilots were flying with the HUD (p_{miss} with HUD = 0.36), than without (p_{miss} without HUD = 0.27; $\chi^2(1) = 4.63$, $p < .05$) producing an **OW HUD Cost of 0.09**. But, if the event occurred head-down in the cockpit, the probability of missing the event was lower (though not significantly) when flying with the HUD (p_{miss} with HUD = .46) than without (p_{miss} without HUD = .51; $\chi^2(1) = .40$, $p = .53$; **non-significant Cockpit Location HUD Benefit = .05**)⁶.

Table 3.7. HUD-Use X Event Location Interaction

| Event Location | Presence of HUD in Cockpit | | χ^2 | p |
|----------------|----------------------------|------------------|----------|------|
| | HUD | No HUD | | |
| OW | 44 / 121 (0.36) | 139 / 523 (0.27) | 4.63 | 0.03 |
| Cockpit | 22 / 48 (0.46) | 63 / 123 (0.51) | .4 | 0.53 |
| χ^2 | 1.3 | 28.14 | | |
| p | 0.26 | 0.001 | | |

⁶ Costs and benefits are provided, even when non-significant, as they are expected to be useful for populating HPMs, the intended purpose of these analyses.

Highway-in-the-Sky (HITS). A HITS display integrates lateral, vertical, and longitudinal information of the flight path into a perspective path through the air (Wickens & Alexander, 2009). While it may be presented either on a HUD or head-down display, it was presented head-down in all ten studies used in our analysis. The probability of missing an event (all events were OW) when flying with a HITS display was higher ($p_{miss} = 0.45$) than when flying without the HITS display ($p_{miss} = .22$; $\chi^2(1) = 31.03$, $p < .001$). This produced a **HITS Cost = 0.23**, presumably due to the fact that the head-down HITS reduced eyes-out time and induced cognitive tunneling (Fadden, Ververs, & Wickens, 2001; Wickens & Alexander, 2009). The HITS cost remained when we consider only the first, truly surprising OW event (p_{miss} with HITS = 0.55; p_{miss} without HITS = 0.33; $\chi^2(1) = 7.01$, $p < .01$; **HITS Cost for Truly Surprising OW Events = 0.22**). These results are presented in Table 3.8. There were insufficient data available to evaluate the HITS X Expectancy and HITS X Event Location interactions.

Table 3.8. HITS-Use Effects

| Event Characteristics | Presence of HITS Display | | χ^2 | $p <$ |
|-----------------------------------|--------------------------|------------------|----------|-------|
| | HITS | No HITS | | |
| OW Events only | 72 / 159 (0.45) | 111 / 494 (0.22) | 31.03 | .001 |
| First Events only (all events OW) | 50 / 91 (0.55) | 19 / 58 (0.33) | 7.01 | .01 |

HITS X HUD Interaction. A HITS by HUD analysis (see Table 3.9) also revealed that when there was a HITS display (always presented head down), there was a clear benefit to having a HUD (p_{miss} with HUD = 0.11 versus p_{miss} without HUD = 0.45; $\chi^2(1) = 3.97$, $p < .05$; **HUD Benefit with HITS display = 0.34**); but when there was no HITS, the HUD produced the classic off-nominal miss effect of Weintraub, Haines, and Randall (1985) in that the miss rate was much higher when flying with the HUD (p_{miss} with HUD = 0.41) than without (p_{miss} without HUD 0.26; $\chi^2(1) = 11.77$, $p < .001$; **HUD costs without HITS display = 0.15**). These data were collapsed across both head-down and OW events.

Table 3.9. HUD-Use by HITS-Use Interaction

| Presence of HUD | Presence of HITS Display | | χ^2 | $p <$ |
|-----------------|--------------------------|------------------|----------|-------|
| | HITS | No HITS | | |
| HUD | 1 / 9 (0.11) | 65 / 160 (0.41) | 3.12 | .07 |
| No HUD | 71 / 158 (0.45) | 131 / 497 (0.26) | 19.4 | .001 |
| χ^2 | 3.97 | 11.77 | | |
| p | .05 | .001 | | |

Datalink. It is expected that NextGen will include datalink communications between pilots and ATC (JPDO, 2007). A great deal of research has evaluated a range of datalink issues such as pilot workload, situation awareness, and heads-down time (e.g., Smith, Polson, Brown, & Moses, 2001). Four studies were identified that compared pilots' ability to detect an off-nominal event (all events were ATC clearance errors) when presented via datalink and/or voice. The probability that a pilot

missed a clearance error was more than twice as high when the clearance was presented via datalink alone ($p_{\text{miss}} = 0.69$) than by voice alone ($p_{\text{miss}} = 0.33$) and voice with datalink together ($p_{\text{miss}} = 0.38$; $\chi^2(2) = 25.73, p < 0.001$). There was no significant difference in the probability of missing the error between voice and voice with datalink ($\chi^2(1) = 0.12, p = 0.72$), so the presence of voice appears to be a buffer, or error-trapping agent, against clearance comprehension errors (see Hooey, Foyle, & Andre, 2001). (The reader is cautioned that the data for voice-only clearance errors are limited to 18 subjects from a single study). A comparison of the Voice with Datalink together and Datalink-only conditions yielded a **Datalink-only Cost of 0.31**.

Table 3.10. Clearance Delivery Main Effect

| Clearance Delivery Method | | | χ^2 | $p <$ |
|---------------------------|------------------|-------------|----------|-------|
| Datalink | Datalink + Voice | Voice Only | | |
| 260/378 (0.69) | 19 / 50 (0.46) | 6/18 (0.33) | 18.19 | 0.001 |

Next, a distinction was made between clearances that were inappropriate (such as a clearance to turn onto an occupied taxiway creating a nose-to-nose conflict) and those that were impossible (such as a clearance to climb to an altitude below that of the ownship’s current altitude). Inappropriate clearances tend to be subtle distinctions that require greater cognitive processing whereas impossible clearances tend to be more salient and obvious. This distinction is relevant for two reasons: 1) The impossible clearances tend to be more salient and obvious where as the inappropriate ones tend to be subtle distinctions that require greater cognitive processing. 2) A miss-rate for inappropriate clearances may be artificially inflated in a HITL simulation as experimental subjects tend to ‘go-along’ with the simulations and not question the appropriateness of the clearance more so than might be the case in the actual environment.

In looking first at inappropriate clearances (See Table 3.11), the probability of missing a clearance error was much higher when the inappropriate clearance was issued via datalink ($p_{\text{miss}} = 0.85$) than when issued by both datalink and voice ($p_{\text{miss}} = 0.5$; $\chi^2(1) = 12.27, p < 0.001$; **Datalink Cost for Inappropriate Clearances = 0.35**), however, the datalink cost was not significant for impossible clearance errors (p_{miss} with datalink = 0.54; p_{miss} with voice and datalink = 0.44; $p > 0.1$; **(non-significant Datalink Cost for Impossible Clearances = 0.1)**. Therefore, the pilots caught the more salient impossible errors equally often with or without datalink, but were hindered by datalink in detecting the less-salient inappropriate errors. This could reflect a criticality difference between the two error types, however there were insufficient data to test this hypothesis.

Table 3.11. Datalink X Error Type Interaction

| Error Type | Clearance Delivery Method | | | χ^2 | p |
|----------------------|---------------------------|------------------|---------------|----------|------|
| | Datalink | Datalink + Voice | Voice | | |
| Inappropriate | 153 / 180 (0.85) | 8 / 16 (0.5) | N/A | 12.27* | 0.01 |
| Impossible | 107 / 198 (0.54) | 15 / 34 (0.44) | 6 / 18 (0.33) | 3.62* | >.1 |
| χ^2 | 42.09 | 0.15 | | | |
| p | 0.01 | 0.70 | | | |

* Chi-square tests compare only datalink and datalink + voice

Graphical Route Displays. Displays that graphically present route information include electronic moving maps for airport surface operations (Hooey, Foyle, & Andre, 2001) or flight procedure rehearsal tools (Arthur, et al., 2004), among others. Four studies were identified that met the meta-analysis criteria and evaluated the effect of graphical displays on pilot detection of off-nominal events. Surprisingly, there was no main effect of the presence of a graphical rendition of the clearance on error detection rates (Table 3.12). When the clearance (regardless of delivery method) was accompanied by a graphical presentation within the cockpit, the probability of missing the clearance error was 0.64 as compared to 0.65 when no graphical depiction accompanied the clearance ($\chi^2(1) = 0.03, p = 0.87$; **non-significant Graphical Route Benefit = 0.01**).

Table 3.12. Graphical Route Main Effect

| Presence of a Graphical Route Display | | χ^2 | <i>p</i> |
|---------------------------------------|--------------------|----------|----------|
| Graphical Route | No Graphical Route | | |
| 99/154 (0.64) | 190/292 (0.65) | .03 | .87 |

However, for events in which the clearance was merely inappropriate, but not impossible (Figure 3.13), it appears as if the graphical presentation did improve event detection (p_{miss} with graphical route = 0.75; p_{miss} without graphical route = 0.86, $\chi^2(1) = 3.6, p = 0.06$; **Graphical Route Benefit for Inappropriate Clearance Errors = 0.11**). The graphical route benefit was not observed for impossible clearances, with the trend in the opposite direction (p_{miss} with graphical route = 0.56; p_{miss} without graphical route = 0.49; $p > 0.1$; **non-significant Graphical Route Cost for Impossible Clearance Errors = 0.07**).

Table 3.13. Graphical Route X Error Type Interaction

| Error Type | Presence of a Graphical Route Display | | χ^2 | <i>p</i> |
|----------------------|---------------------------------------|--------------------|----------|----------|
| | Graphical Route | No Graphical Route | | |
| Inappropriate | 51 / 68 (0.75) | 110 / 128 (0.86) | 3.62 | 0.06 |
| Impossible | 48 / 86 (0.56) | 80 / 164 (0.49) | 1.12 | 0.30 |
| χ^2 | 6.09 | 43.67 | | |
| <i>p</i> | 0.02 | 0.01 | | |

Datalink X Graphical Route Interaction. The extent to which the graphical route effect was moderated by the clearance delivery method was examined. As can be seen in Table 3.14, the analysis yielded an ordinal interaction. When the clearance error was presented via datalink only, the probability of missing the error was higher with the presence of the graphical route ($p_{\text{miss}} = 0.74$) than without graphical routes ($p_{\text{miss}} = 0.66$; $\chi^2(1) = 2.90, p = 0.09$). This resulted in a **Graphical Route Cost for Datalink Clearances of 0.08**. On the other hand, when the clearance was issued by both Voice and Datalink, the presence of graphical routes greatly increased the pilots' detection rates (p_{miss} with graphical route = 0.12 versus p_{miss} without graphical routes = .80; $\chi^2(1) = 23.27, p < .01$). Thus, there was a **Graphical Route Benefit for Datalink+Voice Clearances of 0.68**.

Table 3.14. Delivery Method as Moderated by Graphical Route Displays

| Delivery Method | Graphical Route Displays | | χ^2 | <i>p</i> |
|------------------|--------------------------|--------------------|----------|----------|
| | Graphical Route | No Graphical Route | | |
| Voice | (none) | 6 / 18 (0.33) | | |
| Datalink | 96 / 129 (0.74) | 164 / 249 (0.66) | 2.90 | 0.09 |
| Voice + Datalink | 3 / 25 (0.12) | 20 / 25 (0.80) | 23.27 | 0.01 |
| χ^2 | 35.54 | 10.50 | | |
| <i>p</i> | 0.01 | 0.01 | | |

3.4 Results – Response Latency Analyses

Twelve studies contained response latency data, however, not surprisingly, there were no independent variables that could be compared across all studies. Four variables were identified that could be analyzed by extracting subsets of the data. These were: **Expectancy, Automation Aid Failure, HUD-Use, and Criticality**. Effect sizes are estimated and presented both as a ‘multiplier’ which provides an estimate of the effect of one condition *relative* to another, and as a raw effect size (in seconds). The reader is cautioned that the raw effect size measure tends to be dependent on the scenario tested and the measurement techniques employed by the researcher.

Expectancy. Three studies provided response latency data that allowed for a repeated-measures statistical comparison (paired-*t*-test) of expectancy – that is they provided response latencies for a first event (FE), a truly surprising, untrained event, and also for one or more subsequent events. The mean time to detect the FE was slower ($M = 2.62$ sec; $SD = 0.76$) than to detect subsequent events ($M = 1.50$ sec; $SD = 0.55$) thus producing an **Expectancy Benefit of 1.12 seconds**. The **Expectancy Multiplier of 1.70**, shows that responses to expected events were 1.70 times faster than unexpected events. There were 281 total data points (subjects X events) that contributed to the analyses from three different HITL studies. This analysis lacked statistical power to achieve significance ($t(2) = 1.58$, $p = 0.254$), however, this finding does converge with the previous expectancy findings noted above.

Automation Aid Failure. An interesting and NextGen-relevant variable that emerged from the analysis of available HITL studies was response latencies to an event when an aiding automation failed. From two HITL studies, 72 data points (Subjects X Events) were available to compare response latencies to an event when the detection aid failed versus to the same event but when there was no detection aid at all, using paired *t*-tests. When the pilots were relying on a detection aid that had failed, the response time was longer ($M = 7.65$, $SD = 5.44$) than if they were not relying on the detection aid at all ($M = 5.05$, $SD = 2.05$; $t(1) = 0.491$, $p = 0.71$). **This yields an Automation Aid Failure Cost of 2.60 seconds and a multiplier of 1.50**. This is what we might describe as a classic automation-reliance or “complacency” effect. Unfortunately, there were only two such studies in our data set so statistical significance was not achieved. However, we provide the data here so future work can build on this finding. It is noted here that there is a robust literature exploring the complacency effect, but many of these studies did not meet our other selection criteria and thus were not included here. These criteria could be expanded in future research efforts potentially yielding a more-robust finding.

HUD Use. Response latencies to events in the world were compared when pilots were flying with and without a HUD. In total, there were three studies with data in both conditions allowing for paired comparisons with a total of 48 data points (subjects X events). In all cases the off-nominal events involved traffic visible OW. The data reveal that response times to the OW event were slower when flying with a HUD ($M = 7.86$, $SD = 4.70$) than when flying without a HUD ($M = 6.37$, $SD = 4.70$; $t(3) = 2.137$, $p = 0.122$). Using a one-tailed t -test, this effect approaches significance, and is consistent with those reported in the miss-rate analysis. The data suggest a **HUD Cost of 1.50 seconds and a multiplier of 1.20**, with events taking 1.20 times longer to detect when flying with a HUD than without. It is important to note that the absolute values are of less importance than the relative multiplier here since the actual raw latency times depend greatly on the specific off-nominal scenario parameters (e.g., detection of a truck vs. aircraft, low contrast vs. high contrast etc.) and measurement techniques.

Criticality. A final analysis was conducted to compare events based on criticality. Criticality was defined as the extent to which a mishap would have occurred in the real world, had the event not been detected, and was rated by two researchers⁷. In total there were response latencies for 10 different events, producing 674 data points (355 low-critical such as autopilot malfunctions and visual interrupts and 319 high-critical events such as incursions, and engine failures).

As would be expected, an independent t -test revealed that response times to low-critical events were much slower ($M = 14.24$, $SD = 9.40$) than for highly-critical tasks ($M = 4.97$, $SD = 4.55$; $t(14) = 2.69$, $p = 0.18$). This resulted in a **High Criticality Benefit of 9.30 seconds and a multiplier of 2.90**, suggesting that tasks with high criticality are responded to about 2.90 times faster than tasks with low criticality. Despite the large difference in means, the analysis failed to reach significance due to the high variability.

3.5 Conclusion

3.5.1 Summary

This meta-analysis characterized pilots' miss rate and response latencies for off-nominal events as a function of expectancy, event location, and the presence or absence of various advanced flight deck technologies. It was observed that the miss rate data produced several plausible and significant effects including:

- An overall miss rate of .32
- An unexpectancy cost for first, truly surprising events, especially OW events
- A cockpit location cost
- A HUD cost, especially for OW events
- A HITS cost for OW events
- A datalink cost, especially for inappropriate clearances
- A benefit of graphical routes for inappropriate clearances

⁷ authors BLH and CDW

While the existence of these and other effects confirms prior work, most critically the current analyses provided robust, stable estimates of their effect size in real-world meaningful units. These are vital in their own right, and will serve as one cornerstone for the research reported in Phase 3 (Chapter 4).

An important finding was that the presence of the advanced technologies either hindered off-nominal event detection as was the case for HUDs, HITS, and Datalink, or failed to show a significant benefit for event detection as was expected from the graphical routes. These results may reflect cognitive tunneling effects especially for the HUD and HITS technologies (Fadden, Ververs, & Wickens, 2001; Wickens & Alexander, 2009) and general complacency effects as has been well documented in Parasuraman, Molloy & Singh (1993). This raises a concern for NextGen flight deck design and points to the need for careful consideration of both nominal and off-nominal conditions in the design and evaluation of NextGen technologies and operations. The results of this parameter meta-analysis reveal insights for the development of countermeasures in terms of training, procedures, and on-board alerts and warnings to mitigate the failure to detect off-nominal events. For example, it was seen that when pilots have some forewarning that an event could happen in the simulation studies, the miss rate dropped by 19%. Looking just at OW events, the miss rate was 27% if pilots were forewarned of the possibility of the event. This suggests that training to remind pilots of the possibility of various events (such as runway incursion ‘hot spots’ or areas prone to bird strikes), or displays that indicate traffic or weather in the area, even if they are accompanied with high amounts of uncertainty, may reduce the miss rate. The finding that HUD and HITS both reduced event detection could suggest the need to mandate that airlines adopt procedures specifying that when one pilot uses the HUD or HITS, the other pilot must be eyes-out. Finally, the finding that datalink inhibited event detection, especially for inappropriate clearances, is of concern as these clearance errors are the most difficult for both pilots and automation to detect. This result may reinforce procedures that the pilots read the datalink out loud within the cockpit to maximize error detection.

It is anticipated that the results from this research will be useful for NASA to develop valid and credible predictive HPMs using tools such as NASA’s MIDAS v5 architecture. Accurately representing human behavior computationally requires accurate representations of many processes internal to an operator such as functions that simulate the effects of stressors on skilled performance through workload and timing “exceedances” (as represented in the MIDAS modeling software; Gore & Jarvis, 2005). When the cumulative workload demands of concurrent tasks exceed a pre-defined threshold, the operator is assumed to be at greater risk for shedding tasks or reduced performance levels, thereby leaving the operator vulnerable to error. Understanding when the human operator is most vulnerable permits the development and evaluation of mitigation strategies.

NASA’s MIDAS could make use of these meta-analysis results by using the data to develop algorithms and function calls that reflect a degradation function that is called by the environment only when the model is triggered by the context. These algorithms would predict the impact on performance of the time variable in the model (using the time and the multiplier determined and presented in the meta-analysis phase). Further, MIDAS could use the equations created for the probability of failing to detect an error to cause the MIDAS perception model to miss the onset of some signal. Three examples from Phase 2 are provided to illustrate the manner in which the

MIDAS model (or other human operator models) could use the information from the present NRA (NASA Research Announcement).

The first example occurs when the model encounters an “automation aid failure.” In this context, a function call would be inserted that degrades detection time performance by the following logic; Noticing Time = $x \cdot 1.50$; where x = the time to notice the event without automation, and 1.50 represents the degradation function as determined from the meta-analysis.

A second example of integrating these meta-analysis results into a MIDAS model relates to modeling the effect of expectancy. As was demonstrated previously, a truly surprising event will effect both the probability of detecting the event and the time to notice the event. From the meta-analysis data, two expectancy functions can be generated. 1) Truly Surprising $P(\text{miss}) = \text{Expected } P(\text{miss}) - 0.12$ which shows that the probability of missing the truly surprising event is 0.12 less than missing an expected, but still surprising, event. 2) Truly Surprising Noticing Time = Expected Noticing Time * 1.70; which shows that the time to detect the truly surprising event is 1.70 times longer than the time to detect a somewhat expected event.

Finally, a third example relates to information criticality. If the MIDAS model encounters highly critical information, then an information criticality algorithm triggered such as: Notice Time = $x \cdot [1/2.90]$; which specifies that the time to notice highly critical information is 2.90 times faster than the time to notice less critical information.

Incorporating this logic into MIDAS v5 is rather simple now that the multipliers and algorithms have been identified in the meta-analysis. Further, as these are backed by empirical literature and comprised of multiple studies across different phases of flights, scenarios, and tasks, these robust algorithms lend credibility to the MIDAS model, and subsequent output.

3.5.2 Limitations and Opportunities for Future Research

3.5.2.1 Small Sample Size

Each study included in this parameter meta-analysis was conducted with independent research objectives and therefore all differed on important factors relating to the events, flight scenarios, and measurement techniques. One inevitable consequence of any meta-analysis is that the diverse studies may differ from each other on variables other than those used for classification. In some cases this pooling may cause an increase in variance within a category, diluting the strength of an effect. In other cases, it may cause a confound (e.g., studies with a HUD used, on average, pilots with more experience than those without). While it might, in some cases, have been possible to create an additional category of “experience” (assuming adequate reporting of this variable by the independent researchers) the danger of creating progressively more classification dimensions is that the number of observations within each cell becomes so small that statistical comparisons are challenged. This was even true with the primary variables reported above. While it would have ideally been valuable to examine their joint effects in a full factorial design (e.g., a 2X2X2X2 design for the event miss rates) this would often leave certain cells vacant or with such a small sample size that statistics would be challenged.

3.5.2.2 Data Were Limited to Simulation Studies

As documented above, the data in the present analyses were drawn exclusively from HITL simulation studies as opposed to flight tests or other operational data. It is acknowledged that pilot behavior during simulator experiments can differ from actual operations or flight test experiments for a number of reasons including a perceived lack of consequence. Notably, Newman and Anderson (1994) reported that in studying HUD misalignment with the real world, pilots in simulator experiments tended to ignore the HUD and fly the outside scene, while pilots in flight ignored the real world and flew the HUD. Also, Newman and Anderson noted that during studies of traffic detection, pilots in the simulator failed to observe intruding aircraft, while pilots in flight appeared to detect traffic earlier. This is a real concern that warrants caution in interpreting these analyses, however, unfortunately very little off-nominal event data exist from operational environments such as flight-tests due to the inherent threats to pilot safety of such events, and the difficulty in produced reliable and repeatable off-nominal events in operational settings.

We carefully examined the time records of certain NTSB reports, where off nominal events triggered a pilot response, and flight deck recorder data provided some indication of the timing of compensatory flight control action. However these data proved to be too uncertain to provide reliable estimates of response time.

It is worth noting however, that our original intent was to employ a large sample of real world Air Traffic Controller data into the meta-analysis, specifically examining controller responses to conflict alerts in five different en-route centers (Wickens, Rice, et al., 2008). These data had the ideal characteristics of generating clearly defined miss rates (where a “miss” was defined as a controller non response to an alert). However closer scrutiny of the data revealed that nearly all of these were cases where the controller was probably aware of the alert, but judged it to be false, and hence intentionally ignored it. This of course is a qualitatively different category from the cases of off-nominal misses in the data integrated above.

3.5.2.3 Data Included Studies with Single-Pilot Crews

Many of the studies, particularly the HITS studies, included in the analyses employed a single-pilot, general aviation, crew as test subjects. It is possible that two pairs of eyes in the commercial cockpit could reveal a different (presumably lower) miss rate.

3.5.2.4 Data Were Limited to a Specific Class of Off-Nominals

As discussed previously, the scope of the research was necessarily limited to those off-nominal events with a clear, unambiguous onset with well-defined responses. However, this excludes important off-nominal events that may have had multiple, conflicting cues, or an unambiguous onset such as scenarios in which an event evolved slowly. The same method developed and employed in the present research could be employed to explore other classes of off-nominal events.

3.5.3 Next Steps

By pooling data across disparate HITL studies, many of which lacked statistical power to draw conclusions and generalize findings when considered individually, we identified several factors that have a robust influence on human performance in off-nominal environments. Three of the variables reported here (Expectancy, Event Location, and HITS) were used to validate a model of visual attention (N-SEEV; Wickens et al., 2009) which then was used to predict pilots' responses to off-nominal events in NextGen environments. Following HPM efforts will use a larger set of these meta-analysis findings to populate HPMs with valid estimates of pilot performance to estimate response time and accuracy to off-nominal events in the Next Generation Air Space System and to evaluate proposed mitigating solutions.

CHAPTER 4. PHASE 3: PREDICTING NEXTGEN PERFORMANCE WITH N-SEEV

4.1 Introduction

In Airspace Super Density Operations, pilot performance issues related to attention become even more critical than in current day operations because of the additional requirements likely to be placed on the operators in the NextGen aircraft. The present work was performed to gain insight into pilot performance in the unexpected “off-nominal” conditions.

The psychology of human response to unexpected events can be approached from two overlapping perspectives. On the one hand, ample data exist to show that people’s response to the unexpected slows in inverse proportion to event probability, a finding well incorporated in the Hick-Hyman Law of response time (Fitts & Posner, 1967; Wickens & Hollands, 2000). On the other hand, one can analyze the three information-processing operations that typically take place in real world contexts when unexpected events occur: noticing, diagnosing, and responding. While the processing of all of these may be delayed by low expectancy, more significant is the fact that the first operation may fail altogether: people often do not notice unexpected events, even if these events are relatively salient. This phenomenon is known as *change blindness* (Simons & Levin, 1997; Rensink, 2002; Stelzer & Wickens, 2006) or inattentive blindness. In a classic study of situation awareness breakdowns in aviation, Jones and Endsley (1996) observed that the majority of such breakdowns occurred at the first phase of SA (noticing and perception), rather than later phases of diagnosis and prediction. Furthermore, tragedies in aviation can be associated with failures to notice critical off-nominal events, such as the failure of a position broadcast (NTSB, 2006) or the unintentional decoupling of an autopilot and subsequent low altitude alert in a commercial airline crash into the Everglades (Nakao, 1994; Wiener, 1971). There is an important distinction to be drawn here between ‘somewhat surprising’ unexpected events (which often produce slower response times than expected events), and truly surprising ones (which may be missed altogether). Taleb (2007) has referred to these as “gray swans” and “black swans” respectively.

The modeling of pilot response delay (or non-response) to unexpected events is particularly important for projections of NextGen procedural safety because of the time and money required to carry out pilot-in-the-loop (PITL) simulations. Also, manipulations that can be made in PITL simulations may be limited, particularly for conceptual systems and procedures for which pilots may not have experience, and hence the subject population for PITL simulations will not be typical of the future population anticipated to execute those procedures. Valid computational models that can make predictions about performance in operationally meaningful units (e.g., seconds saved, events missed) can fill this gap. While such models may not be able to offer precise predictions of optimal configurations, they often can signal poor designs, and can be used to narrow the parameter space that should be examined should be examined more thoroughly with PITL research. One such computational model is NASA’s Man-Machine Integration Design and Analysis System (MIDAS; Gore, 2008).

The objective of this final phase of research was to apply, refine, and validate a model that predicts the time to notice off-nominal events and apply this to future NextGen scenarios. The SEEV model of human attention (see Wickens, Goh, Helleberg, Horrey, & Talleur, 2003; Wickens & McCarley, 2008; Wickens, McCarley, Alexander, Thomas, Ambinder, & Zheng, 2008), comprised of four

parameters (Saliency, Expectancy, Effort, and Value) was modified to create Noticing-SEEV (N-SEEV). This phase of the research included four elements:

- 1) Apply and refine a computational model (N-SEEV) to predict response parameters for off-nominal events.
- 2) Validate N-SEEV by comparing output to the meta-analysis data reported in Phase 2 above.
- 3) Conduct a sensitivity analysis to provide miss rates as a function of event location and event saliency.
- 4) Use the validated model to predict pilot responses to future NextGen scenarios.

4.2 SEEV Model

SEEV is a computational and plausible model that accounts for how four quantifiable elements do and/or should drive pilot's attention around the cockpit environment. While attention formally includes all aspects of selective attention, in most applications we use foveal vision (the direction of scan) as a proxy for attention (although the SEEV model has been expanded to include auditory attention as well; Wickens et al. (2008), application 1). This current application of SEEV uses foveal vision as attention.

Research (e.g., Wickens & McCarley, 2008; Wickens et al., 2003) suggests that attention is driven by saliency (S) (salient events capture attention), and inhibited by effort (Ef) (we sometimes do not switch attention when doing so requires a long eye movement or head movement; attention is "lazy"). Attention is driven by looking to where we expect (Ex) to gain high value (V) (support important tasks) information. Thus the factors:

S, (-Ef), Ex and V **do** drive attention.

However the case can be made that only Ex and V **should** drive attention, since these are the two parameters that characterize the optimal *expected-value* decision making of where people should look (or attend) to gain information. Only if saliency is directly correlated with value (valuable sources are made salient by the designer), should saliency influence scanning. In this sense, saliency and effort are "nuisance variables" that inhibit optimal scanning.

Note that in thinking about optimal attention allocation, there is a question of whether "optimal" should be described by the product $\{E \times V\}$, as in traditional expected value decision theory, or the sum $\{E + V\}$. For various reasons described in Wickens et al. (2008), we have chosen the latter term.

A key element in the SEEV model is the Area of Interest (AOI), a region in visual space, such as the primary flight display, or outside world, where attention is assumed to be fixated at any one period (note that several successive fixations can take place within a single AOI, as when the pilot's eye scans around the single AOI that is the outside world).

4.2.1 SEEV Parameters

SEEV parameters are described below.

- **Saliency** of visual events can often be given three simple levels based on an analyst’s coding. Saliency of auditory events is typically the maximum value ($S_{\max} = 2$). The onset of visual events in or near foveal vision has a saliency of one ($S = 1$). Changes that are out of foveal vision have a saliency of zero ($S = 0$). More elaborate models of attention are available also, to create more gradations of saliency coding. (See Wickens & McCarley, 2008).
- **Effort** to move attention between two areas of visual interest can be assigned a value of 1 if elements are contained within the same display, 2 for adjacent displays, and 3 for displays with one or more intervening display(s). Again, more elaborate coding is possible; e.g., that based on visual angle.
- **Expectancy** is directly related to the frequency or *bandwidth* (BW) with which events occur within an AOI. This can be actually measured and expressed in Hertz (cycles/second, or events/second), or it can be more conveniently assigned an ordinal value from 0 (no change at all; a static display) to 1 to N , where N is the most rapidly changing display, and is dictated by the sum of all changing variables within that display.
- **Value** is determined by the **importance** of the task(s) served by the AOI(s), coupled with the **relevance** of the AOI to the task(s) it serves. Thus if there are three tasks, and they can easily be rank ordered in importance, the AOI serving the most important task will have a value of 3, that serving the least, a value of 1, and that serving the middle task, a value of 2. Note that if an AOI serves two tasks, its value will be the sum of the value of the two tasks it serves.

4.2.2 How the Model Works

Attention is assumed to start fixated on an AOI. At this point its next move is governed by the “attentional attractiveness” of all surrounding AOIs, and of itself. For each AOI that attractiveness is determined by the expected value of the AOI ($E+V$), the saliency of the AOI, and inhibited by a value equal to the effort required to get there. (The effort of staying put is, of course, 0). Thus there will be a range of attractiveness values across the number of AOIs specified by the analyst. These relative values determine the probability that attention will move, and to where it is likely to move. For example if there are two AOIs, and at any given time there is a computed attractiveness value of 2 for staying put, and 2 for moving, there will be a 50-50 chance of moving or staying put (the latter implying a longer dwell where you are). As the model runs over time, it generates frequency distributions of attention transitions between all possible pairs of the N AOIs. The model creates an $N \times N$ matrix of transitions between all AOIs. From this matrix, it is possible to derive the number of visits to each AOI: this corresponds to the probability of attending to each AOI.

If a salient event is triggered to occur in an analyst-determined script file (e.g., onset of a wake vortex alert), this adds a discrete increment to the attractiveness of the AOI where the event occurs, that remains in force until attention first lands on that AOI, at which point the saliency returns to 0, and the model software measures the attention switching time between the event and that first fixation (Wickens, Sebok, et al., 2007).

We can define different model versions characterized by the parameter values during particular phases of flight. For example consider a parallel approach situation with a wake vortex display in the

cockpit. When there is no wake vortex coming off of the lead aircraft, then an AOI dedicated exclusively to wake information (e.g., a wake display) has no bandwidth (since there is no display), and the task of wake vortex monitoring has a lower value than does the task of wake vortex tracking, a task which is activated when the wake symbol appears, (the same event which also turns the salience of the wake to its pre-specified value).

At the end of N model runs with fixed parameter settings, the model gives both N values (percentage dwell time, or probability of attending to each AOI), as well as a plot over time of the movement of the eyeball across the displays.

4.2.3 Level of Detail

As a predictive model, the SEEV model can get as detailed as the analyst desires. The maximum level of detail is defined by how small a particular AOI can be specified uniquely characterize its bandwidth, and the task(s) that it supports. Thus for example, we could define an AOI as simply the Primary Flight Display; or we could get more detailed (as we do) and define two AOIs within this display, the highway in the sky, and the wake symbol. Or we could get still more detailed and subdivide the wake symbol into two AOIs, the current location, and the predicted location. There are limits to the degree that the model can be evaluated and validated against empirical scanning data however. The limitation on model detail is determined by the precision or resolution with which the scan measuring equipment can determine exactly where the eye is attending (e.g., within 5 degrees, 10 degrees.)

4.3 Noticing SEEV (N-SEEV) Model

The N-SEEV model is an elaboration of the SEEV model (Wickens et al, 2003; Wickens et al, 2008), which predicts how visual attention (saccadic eye movement) is guided in large scale environments by the **salience** of events, inhibited by the **effort** required to move attention across the visual workspace, and attracted to locations according to the **expectancy** of seeing an event at a particular location, and the **value** of that event (or cost of missing it). The original SEEV model developed by Wickens et al. (2003) was further refined in collaboration with University of Illinois (Wickens, McCarley, Steelman & Sebok, in preparation⁸). The refined version, the N-SEEV of visual attention, allows the user to employ SEEV to predict steady state scanning, and then use a salience model based on the work of Itti and Koch (2000) to predict the time for attention capture by an event of a given salience at a designated location in the display space while scanning is ongoing. There are several parameters in the model (Wickens, McCarley, Steelman, & Sebok, in preparation; Wickens, Sebok, Kamienski, & Bagnall, 2007) but the most important of these for the present use are:

- Salience of different areas of interest (AOI).

⁸ Control of Attention: Modeling the Effects of Stimulus Characteristics, Task Demands, and Individual Differences – ROA 2007 (NNX07AV97A)

- Importance (value) of each area of interest; equivalent, as in SEEV to the importance of the task served by the AOI X the relevance of that AOI to the task.
- Bandwidth of the AOI, corresponding to the frequency of change. It is assumed in the model that frequency of change is well represented by the pilot's expectations, and hence bandwidth is a proxy for expectancy.
- Saliency of the event-to-be noticed. This is based on the Itti and Koch (2000) model, and is designated in the N-SEEV model by creating a pre and post-change image of the cockpit display. From the images presented below, the model computes the saliency of the difference between them. Hence, as opposed to the first three parameters, specified numerically, the saliency is specified graphically. An example of this image is shown in Figure 4.1 below.
- Visual field of view (sigma); a parameter that can be reduced in visual angle if there is high stress or cognitive workload.
- An "inhibition of return" (IOR) parameter that specifies the likelihood that a fixation on an AOI can return immediately to that AOI, rather than requiring it to travel elsewhere. Such an immediate re-fixation can be plausible for a highly valued AOI.
- Pertinence weights for saliency, change, expectancy and value. These essentially establish the extent to which scanning is driven by the former two (bottom up) versus the latter two (i.e. top down) processes.
- Within color, pertinence weights for different specific colors (such as, in the current application, a high weighting for red and amber).

Importantly, the model captures the eccentricity effects, such that events are less likely to be detected as they fall increasingly farther in the periphery from the momentary location of the scan.

The model has previously been validated and model parameters established using a data set of visual scanning from a Boeing cockpit automation study (Mumaw et al., 2000; Sarter, Mumaw, & Wickens, 2007), and using a data set of event noticing time, and miss rate. The model was also validated for a more basic laboratory experiment by Nikolic, Orr, and Sarter (2004) that simulated the noticability of flight mode annunciator changes in the cockpit. These validations can be found in McCarley et al. (in preparation).

4.4 Validation Against Meta-Analysis Miss Rate Data

The meta-analysis described in Phase 2 identified several key variables that had robust (e.g., highly reliable) effects on off-nominal miss rate. Three of these in particular, could be described in a manner that corresponded to N-SEEV parameters. These were:

- Expectancy costs: truly surprising events were detected less well than simply unexpected events, when these events occurred OW (0.50 vs 0.23 miss rate respectively).
- Highway-in-the-sky (HITS) cost to detect truly surprising OW events (0.55 HITS vs 0.26 no-HITS).
- Costs for detecting unexpected (but not 'truly surprising') head down events (0.37) relative to OW events (0.23)

A fourth robust effect was the HUD cost to detecting OW events; that is, the classic Fischer, Haines, and Price (1980) finding. However, this cost appears to be related to the masking of the event by clutter, an issue that our model is not equipped to easily address, so this was not examined.

As a context for model testing and validation, we configured a cockpit layout shown in Figure 4.1, assumed to subtend a visual angle of approximately 40 X 60 degrees. The cockpit layout included fifteen AOIs that correspond to typical glass cockpit flight deck displays. These AOIs correspond to different instrumentation on current-day and NextGen aircraft (e.g., datalink and an electronic flight bag are included.) The sizes of these AOIs correspond to the relative sizes of the instruments on the flight deck. The AOI's on the figure represent the location of onsets or offsets that were evaluated using N-SEEV. Within this area, the field of view (FOV) parameter sigma was set to 100 pixels; the same value that had provided the best fit for the Nikolic et al. (2004) data that subtended the same visual area.

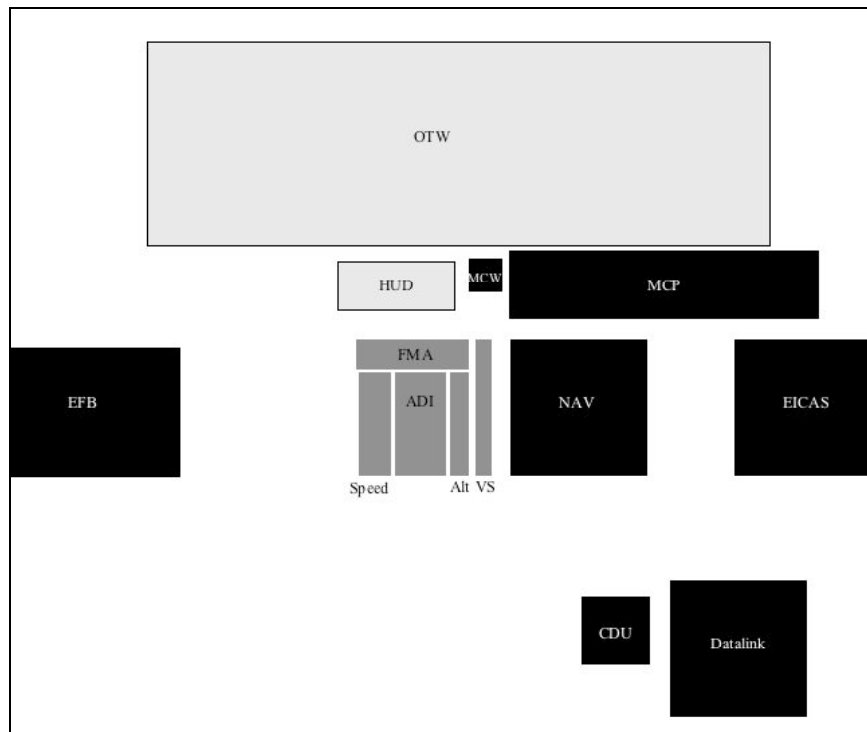

Figure 4.1. Cockpit layout with 15 Areas of Interest (AOI). The off-nominal (ON) event is either out the window (OTW) or positioned at one of the other display locations within the cockpit. Different shades of black/grey refer to rough color of the AOI.

Notes: ADI = Attitude Direction Indicator; Alt = Altitude; CDU = Control Display Unit; EFB = Electronic Flight Bag; EICAS = Engine Indicating and Crew Alert System; FMA = Flight Mode Annunciator; HUD = Head-Up Display; MCP = Mode Control Panel; MCW = Master Caution and Warning Light; NAV = Navigation Display; VS = Vertical Speed; OTW = Out-the-Window.

One analyst (CDW) who is an expert on SEEV model applications, having developed parameters for seven such previous validation applications (Horrey, Wickens, & Consalus, 2006; Wickens et al.,

2003; Wickens et al., 2008; Wickens et al., 2007), identified the AOIs that had been active in most of the experiments upon which the meta-analysis data were based. The assumption we made here is that most of the data points for this meta-analysis were contributed by studies in the non-automated, general aviation (GA) cockpit, and hence both the value and bandwidth of AOI's associated with the Flight Management System (FMS) of the automated cockpit (e.g., control display unit, CDU; mode control panel, MCP; flight mode annunciator, FMA) were set to 0. It was also assumed, since most of the studies whose data entered into the analysis were conducted during descent or final approach phase, that demands should be configured as typical of this phase (e.g., rather than cruise, take-off, or taxi).

It is important to note that the model output, a scan pattern across AOI's and an event noticing time estimate, is actually a distribution of noticing times, whose variance is attributable to where the scan happens to be when the event occurs (for example noticing the event at the very top of Figure 4.1 will be fast if the scan is on the OW, but slow if it is on the CDU because the CDU is farther from the AOI where the event occurs). Since we must translate the NT estimate distribution into a miss-rate percentage, it was necessary for us to establish a (somewhat arbitrary) criterion (Crit), on the distribution, defining the number of saccades before the target was noticed, and after which the target would not have been noticed. The latter figure constitutes "misses", and hence the miss rate is calculated as this number divided by 1000, the number of model iterations used for each Monte-Carlo simulation run. We also assumed this to be either 15 or 20 saccades (the model was run with 15 saccades, and again with 20 saccades), and assumed the fixations to be 1/2 second per saccade and its associated fixation. Hence our assumption is that if the event was not noticed within either 7.50 (Crit = 15) or 10.00 (Crit = 20) seconds, it was "missed". (We compare below these two time estimations). Justification for these criterion values, which essentially define the setting on a speed-accuracy tradeoff, is provided in McCarley et al. (in preparation).

Table 4.1 presents the parameters for the first four model runs that were used to examine the expectancy effect (top two sub-tables) and the HITS cost (bottom two). The calculated miss rate from the distribution, using a criterion of 15 saccades/fixations, is shown at the bottom of each sub-table. The best way of interpreting the criterion value of 15 saccades is that it represents a predicted *miss rate* if the pilot stopped looking for a target after 7.50 sec (at 1/2 second saccades). We compared the predicted with obtained miss rates and RT's for the four conditions in Table 3.1 (low expectancy, high expectancy, HITS, no HITS) and observed the best overall model fit was with a criterion of 15 saccades (Crit = 15). In addition, work reported in McCarley et al (in preparation) also found a Crit = 15 value was optimal. Given these two factors, the criterion of 15 saccades was chosen for model runs reported in the current phase⁹. Before turning to the miss rate analysis the most important aspect of this simulation we briefly call attention to the percent dwell time (PDT) data, generated across all AOI's and shown in the right column of each sub-table. Across the two top sub-tables, there is only one substantial difference: increasing expectancy (or bandwidth) for the off-

⁹ Note, four model runs were completed to examine the expectancy effect and the HITS cost using Crit = 20 saccades. We compared the predicted with obtained miss rates and RT's for the four conditions, and observed the best overall model fit occurred with Crit = 15. In addition, work reported in McCarley et al. (in preparation) also found that a Crit 15 value was optimal. Hence, Crit=15 was chosen for the model runs reported in the current phase.

nominal event that is presented in row 1, causes the eye to fixate there more frequently (4.5% vs 3%).

Table 4.1. Parameters for Four Model Runs

| Expectancy Comparison (runs 1 vs 3) | | | | | | | |
|--------------------------------------|--------------------|-------------|--------|-----------------|--------------------|-------------|--------|
| Low Expectancy | | | | High Expectancy | | | |
| AOI | Value | Bandwidth | PDT | AOI | Value | Bandwidth | PDT |
| 1 Off-Nominal | 0.10 | 0.00 | 0.030 | 1 Off-Nominal | 0.10 | 0.20 | 0.045 |
| 2 OW | 0.30 | 0.40 | 0.129 | 2 OW | 0.30 | 0.40 | 0.127 |
| 3 HUD | 0.00 | 0.00 | 0.001 | 3 HUD | 0.00 | 0.00 | 0.001 |
| 4 MCP | 0.00 | 0.00 | 0.003 | 4 MCP | 0.00 | 0.00 | 0.003 |
| 5 Spd | 0.30 | 0.20 | 0.090 | 5 Spd | 0.30 | 0.20 | 0.089 |
| 6 FMA | 0.00 | 0.00 | 0.048 | 6 FMA | 0.00 | 0.00 | 0.047 |
| 7 ADI | 0.60 | 0.80 | 0.274 | 7 ADI | 0.60 | 0.80 | 0.270 |
| 8 Alt | 0.60 | 0.30 | 0.147 | 8 Alt | 0.60 | 0.30 | 0.144 |
| 9 VS | 0.60 | 0.40 | 0.118 | 9 VS | 0.60 | 0.40 | 0.116 |
| 10 ND | 0.40 | 0.20 | 0.108 | 10 ND | 0.40 | 0.20 | 0.106 |
| 11 EICAS | 0.20 | 0.10 | 0.053 | 11 EICAS | 0.20 | 0.10 | 0.052 |
| 12 Datalink | 0.00 | 0.00 | 0.000 | 12 Datalink | 0.00 | 0.00 | 0.000 |
| 13 CDU | 0.00 | 0.00 | 0.000 | 13 CDU | 0.00 | 0.00 | 0.000 |
| 14 EFB | 0.00 | 0.00 | 0.000 | 14 EFB | 0.00 | 0.00 | 0.000 |
| 15 MCW | 0.00 | 0.00 | 0.001 | 15 MCW | 0.00 | 0.00 | 0.001 |
| | Noticing Time | | 15.677 | | Noticing Time | | 11.672 |
| | Standard Deviation | | 16.669 | | Standard Deviation | | 12.191 |
| | miss rate* | | 0.39 | | miss rate* | | 0.29 |
| HITS Comparison (runs 4 vs 5) | | | | | | | |
| HITS | | | | No-HITS | | | |
| AOI | Value | Bandwidth | PDT | AOI | Value | Bandwidth | PDT |
| 1 Off-Nominal | 0.10 | 0.00 | 0.029 | 1 Off-Nominal | 0.10 | 0.00 | 0.046 |
| 2 OW | 0.20 | 0.40 | 0.116 | 2 OW | 0.60 | 0.40 | 0.198 |
| 3 HUD | 0.00 | 0.00 | 0.001 | 3 HUD | 0.00 | 0.00 | 0.000 |
| 4 MCP | 0.00 | 0.00 | 0.003 | 4 MCP | 0.00 | 0.00 | 0.004 |
| 5 Spd | 0.30 | 0.20 | 0.098 | 5 Spd | 0.30 | 0.20 | 0.096 |
| 6 FMA | 0.00 | 0.00 | 0.055 | 6 FMA | 0.00 | 0.00 | 0.041 |
| 7 ADI | 1.00 | 1.00 | 0.354 | 7 ADI | 0.30 | 0.50 | 0.214 |
| 8 Alt | 0.30 | 0.30 | 0.131 | 8 Alt | 0.40 | 0.30 | 0.124 |
| 9 VS | 0.20 | 0.40 | 0.078 | 9 VS | 0.30 | 0.40 | 0.096 |
| 10 ND | 0.20 | 0.20 | 0.079 | 10 ND | 0.40 | 0.20 | 0.119 |
| 11 EICAS | 0.20 | 0.10 | 0.056 | 11 EICAS | 0.20 | 0.10 | 0.060 |
| 12 Datalink | 0.00 | 0.00 | 0.000 | 12 Datalink | 0.00 | 0.00 | 0.000 |
| 13 CDU | 0.00 | 0.00 | 0.000 | 13 CDU | 0.00 | 0.00 | 0.000 |
| 14 EFB | 0.00 | 0.00 | 0.000 | 14 EFB | 0.00 | 0.00 | 0.000 |
| 15 MCW | 0.00 | 0.00 | 0.001 | 15 MCW | 0.00 | 0.00 | 0.002 |
| | Noticing Time | | 16.311 | | Noticing Time | | 11.597 |
| | Standard Deviation | | 17.040 | | Standard Deviation | | 12.686 |
| | miss rate* | | 0.41 | | miss rate* | | 0.28 |
| *Crit = 15 | | | | | | | |

Notes: Percent dwell time (PDT) is in the right column. Noticing time for the off-nominal event is expressed in number of fixations. Miss rate assumes a cutoff of 15 fixations. ADI = Attitude Direction Indicator; Alt = Altitude; AOI = Area of Interest; CDU = Control Display Unit; EFB = Electronic Flight Bag; EICAS = Engine Indicating and Crew Alert System; FMA = Flight Mode Annunciator; HUD = Head-Up Display; MCP = Mode Control Panel; MCW = Master Caution and Warning Light; ND = Navigation Display; VS = Vertical Speed; OW = Out-the-Window; Spd = Speed.

In the bottom two sub-tables, comparing HITS (left) with no-HITS (right), we note that the substantial increase in both value and bandwidth parameters assigned to the Attitude Director

Indicator (AOI: ADI; assumed here to be host of the HITS), and this caused an increase in ADI PDT from 21% (no HITS) to 35% (HITS), while there was a corresponding decrease in OW scanning from 20% (no HITS) to 10% (HITS). These results, along with scanning to other AOIs are shown graphically in Figure 4.2. It is important to note that this 10% OW value approximates that value observed in an empirical cockpit scanning study of pilots using the HITS, as reported by Wickens et al. (in preparation).

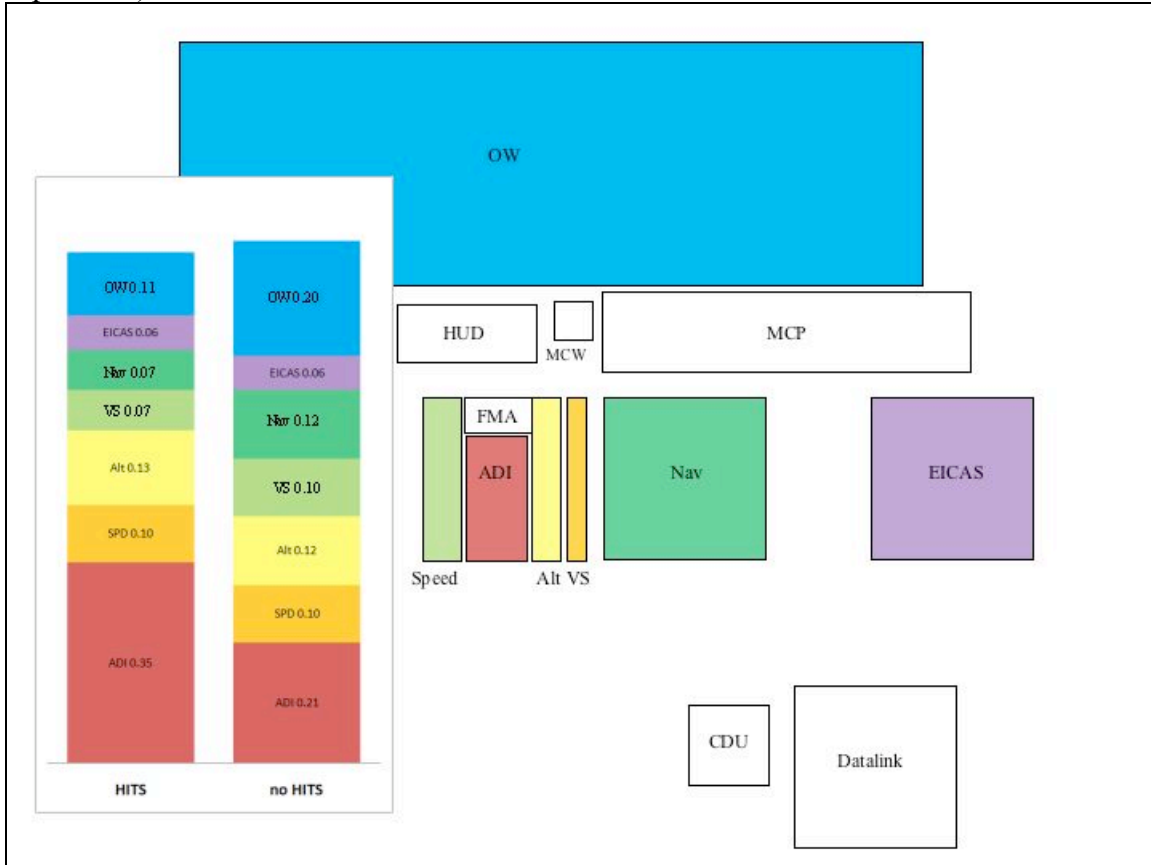

Figure 4.2. Stacked bar graph showing the percent dwell time (PDT) in key areas of interest for HITS (left) and non-HITS (right) trials. The color-coding within the bars matches the color-coded AOI's on the image. The tradeoff between OW scanning and ADI scanning (where the HITS is hosted) is evident.

Notes: ADI = Attitude Direction Indicator; Alt = Altitude; CDU = Control Display Unit; EICAS = Engine Indicating and Crew Alert System; FMA = Flight Mode Annunciator; HUD = Head-Up Display; MCW = Master Caution and Warning Light; MCP = Mode Control Panel; Nav = Navigation Display; VS = Vertical Speed; OW = Out-the-Window.

We now focus on the noticing time data for these four model runs. The top row (AOI#1) of each sub-table in Table 4.1 is the off-nominal, or to-be-noticed event. For these runs, it was defined as the AOI just above the OW in Figure 4.1. We placed the off-nominal event just above the window because a modeling constraint prevents overlapping AOIs,¹⁰ and it was assumed that the most likely

¹⁰ Because of this modeling constraint, all off-nominal events reported here were located as close to the reported AOI as possible.

scenario for an off-nominal event would be on final approach, where the aircraft would be pitched down, and hence objects on the runway would be likely to be higher, rather than lower in the pilots outside view.

Turning first to the expectancy effect (the two top sub-tables of Table 4.1), we note that the only difference between cell values on the left and on the right of the upper tables is the setting of bandwidth parameter for AOI #1 (off-nominal event), which is set to 0.20 for “unexpected” and 0 for truly surprising. (We also ran a model run with a setting of 0.10 for unexpected events, however the data provided the best fit to the model with BW set at 0.20). Note that 0.20 lies along a scale from 0 to 1.00 where 0 is truly surprising and 1.00 is maximum expectancy. As seen at the bottom of the two sub-tables, the predicted miss rate for low (BW = 0) vs. higher expectancy (BW = 0.20) is 0.39 and 0.29 respectively. This corresponds with the observed miss rates from the meta-analysis of 0.50 and 0.23 respectively.

The bottom two sub-tables of Table 4.1 depict the parameters chosen to simulate the HITS-imposed cost, for detecting truly surprising OW events. Here the main difference between the left (HITS) and right (no HITS) panel lies in the much greater value and BW parameters associated with the ADI when the HITS is present, whose effects were depicted in Table 4.1 and Figure 4.2. On the right, in the absence of the HITS, the model parameters specify that the outside world is much more valuable (higher value coefficient), since this is now the only source of evidence for altitude over hazardous terrain, and the navigation display (ND) becomes more valuable (than when the HITS is present) because the ND is the source of horizontal trajectory information.

At the bottom of these two sub-tables, we depict the predicted miss rate 0.41 (HITS) vs 0.28 (no-HITS) for noticing the truly surprising OW event. This corresponds with observed values from the meta-analysis of 0.55 and 0.33 respectively.

Our next model analysis was carried out to predict the difference in off-nominal event location (OW vs cockpit). To do this, we created a second image in which, within the context of Figure 4.1, the off-nominal event was low in the cockpit below the ADI. Because we wished to observe this location effect unconfounded by event salience, we used identical pre- and post-change off nominal event images, to those that had been used when the event-to-be-noticed was OW. Using all other model parameters identical to the higher expectancy (BW = 0.2) non-HITS trials, shown in Table 4.2 (with the setting Crit = 15), we observed predicted $p(\text{miss}) = 0.29$ (OW) and 0.48 (cockpit), compared with the meta-analysis empirical data of 0.23 and 0.41 respectively. These findings indicate that this “location effect” is relatively similar between the predicted data (difference = 0.14) and the obtained data (difference = 0.18).

Table 4.2. Model-Predicted Miss Rates as a Function of Event Location and Salience

| Run | Off-Nominal Event Location | Off-Nominal Event Salience | Miss Rate |
|-----|----------------------------|----------------------------|-----------|
| 6 | OW | Non-salient event | 0.29 |
| 7 | Cockpit | Non-salient event | 0.48 |

Collectively, we have plotted all six conditions in the scatter plot shown in Figure 4.3, and connected each of the three pairs of points being contrasted in the low- expectancy cost, the HITS cost (for truly surprising OW events) and event location cost (for unexpected but not truly

surprising events). Crit = 15 was used in all cases. The figure illustrates all three effects for which models were run. Importantly, a regression line fit through the points shown by the dashed line reveals a modestly high ($r = 0.73$) correlation. We believe this is a reasonably good fit given the heterogeneity of variables that were varied across the six conditions. We also note that a slope value reasonably close to 1.00 (1.20) and an intercept reasonably close to 0 (0.05). These close proximities mean that not only are changes in model predictions echoed in changes in obtained data (the high correlation), but the actual value of predicted miss rate corresponds closely to the actual value obtained. We also note two additional positive features of the model fit. First, for four of the points, the difference between predicted and obtained fit is within 7%, and for all six it is within 14%. Second, the slopes of each individual effect cluster around 1.0, from a value of 0.95 (the down location cost) to 1.7 (the HITS cost) to 2.7 (the expectancy effect). It is important to highlight this last finding, because it would have been possible for the high regression value to be obtained for all six, even as each effect itself was negative (e.g., a set of three short lines running parallel to the negative diagonal). The precise reason for the difference in slope across the three effects remains to be established.

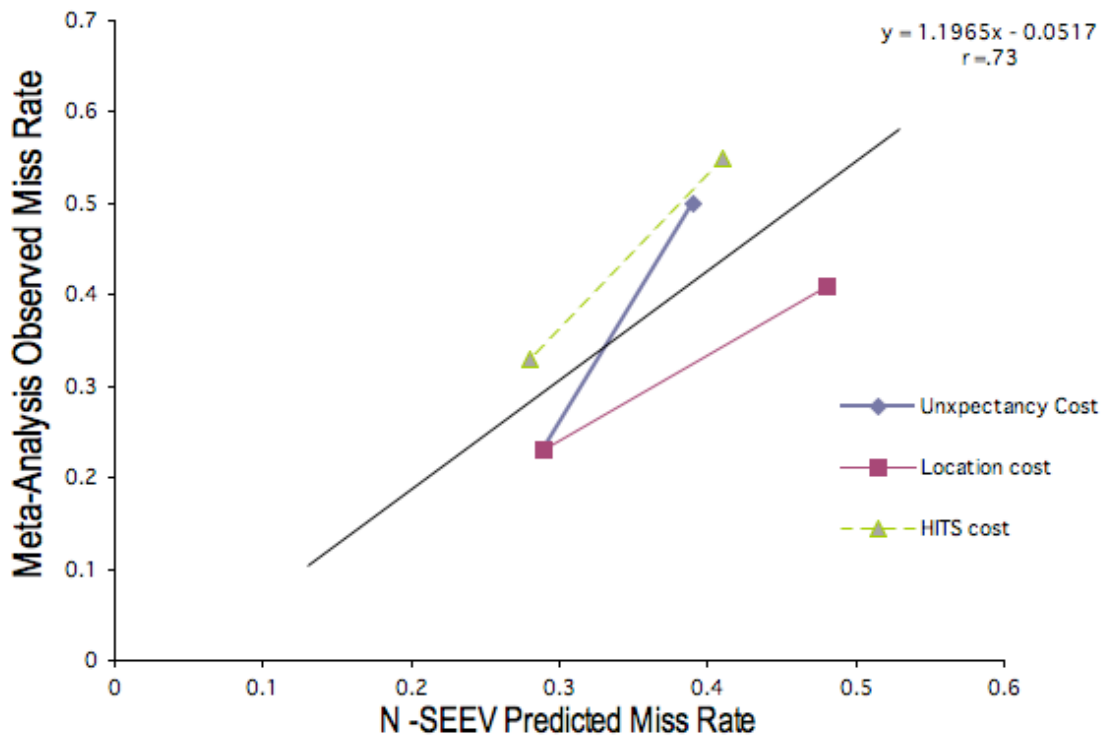

Figure 4.3. Model Predicted and Meta-analysis Obtained Miss Rate, associated with the Expectancy Effect, HITS cost, and Cockpit Location Cost Crit = 15. Best fitting regression line is the dashed line ($r = 0.73$; slope = 1.2).

In interpreting the model-predicted miss rates (and effects on miss rates), it is also important to consider the model variability that results across repeated model runs, as this variability allows us to compute a standard error of miss rate estimate, and, correspondingly a 95% confidence interval (two standard-errors). Because the Monte Carlo model runs 1000 iterations for each estimate, we can

compute this standard error based on estimates of standard error of proportions (Hayes, 1981). While such estimates vary with the absolute level of that proportion, (increasing with its deviation away from 0.50), we compute that the largest 95% confidence interval is approximately 0.03. Thus any two predicted model points that differ by more than this amount can be said to be “statistically significant ($p < 0.05$)”. We note in Figure 4.3, that all three predicted model effects differ by margins considerably greater than this value.

4.5 Sensitivity Analysis for Parameter Changes

We next chose to exercise the model across a series of different images that would assess model sensitivity to variables that would be expected to influence the noticeability of the off-nominal event. Here, noticeability is operationally defined by miss rate, with a Crit of 15 saccades). First, we varied location of an off-nominal event that was considered a non-salient event, and that was identical in salience to the event used in the six prior model runs. Then we controlled the location, to be located on the ADI, and varied the salience. The event locations and salience, and their model-predicted miss rates are shown in Table 4.3. Note that for the “Non-salient events” identified in Runs 8, 9 and 10 the indication was a desaturated yellow (red – 255, green – 255, blue – 204) that transitioned to a desaturated blue (red – 204, green – 236, blue – 255).

Table 4.3. Model-predicted Miss Rates as a Function of Event Location (Runs 8-10) and Salience (Runs 11-13)

| Run | Off-Nominal Event Location | Off-Nominal Event Salience | Miss Rate |
|-----|----------------------------|----------------------------|-----------|
| 8 | Between CDU and Datalink | Non-salient event | 0.57 |
| 9 | HUD | Non-salient event | 0.30 |
| 10 | ADI | Non-salient event | 0.22 |
| 11 | ADI | Amber alert | 0.18 |
| 12 | ADI | Red alert | 0.18 |
| 13 | ADI | Offset | 0.60 |

Notes: CDU = Control Display Unit; HUD = Head-up Display; ADI = Attitude Direction Indicator.

In large part, the noticing time values in the top half of Table 4.3 confirm expectations. Miss rate is greater when the event is buried deeper in the cockpit (run 8) than near the primary flight displays (runs 9 and 10). In runs 11-13, we examine differences in event salience, with all events occurring on the ADI, the location for the non-salient event in run 10. Compared to the relatively dull changes (de-saturated yellow to de-saturated blue) in model run 10 (miss rate = 0.22), the amber onset (run 11) event was missed much less frequently (0.18). Surprisingly however, when the same alert was red (run 12), it was no better detected. Finally, when the event at the same location (ADI) was an offset rather than an onset, its miss rate increased substantially from 0.22 (run 10) to 0.60 (run 13). This model prediction is validated by the well-know amplification of change blindness to event offsets, relative to onsets (Rensink, 2002).

4.6 Predictions for NextGen Technology and Procedures

Next model predictions were generated for a set of different NextGen scenarios as defined in Phase 1 of this research effort. These scenarios did not have sufficient data from existing studies for a

meta-analysis to provide empirical data for validation. Hence what areshown below are only predictions. In the all-important choice of how to populate the parameters for the matrices above, (i.e., in the format of Table 4.1) we assumed an automated cockpit. Hence we approximated the BW and value parameters for AOIs that had previously been used to validate the Boeing cockpit study carried out by Sarter, Mumaw, & Wickens (2007) and Mumaw et al. (2000). Those parameters can be found in McCarley et al. (in preparation).

4.6.1 NextGen Approach Scenarios with and without an Electronic Flight Bag

Here we adopted a NextGen approach/arrival scenario, tailoring the value and BW parameters typical of that flight phase, as shown in Table 4.4.

Table 4.4. Value and Bandwidth (BW) Parameters and Percent Dwell Time (PDT) for an Automated Cockpit During Approach Phase (shown here with the EFB not in use)

| AOI # and location | Value | BW | PDT |
|---------------------|-------|------|------|
| 1 Off-Nominal Event | 0.10 | 0.00 | 0.03 |
| 2 OW | 0.30 | 0.40 | 0.12 |
| 3 HUD | 0.00 | 0.00 | 0.00 |
| 4 MCP | 0.20 | 0.10 | 0.04 |
| 5 Spd | 0.30 | 0.20 | 0.08 |
| 6 FMA | 0.10 | 0.10 | 0.06 |
| 7 ADI | 0.60 | 0.80 | 0.25 |
| 8 Alt | 0.40 | 0.30 | 0.12 |
| 9 VS | 0.60 | 0.40 | 0.10 |
| 10 ND | 0.40 | 0.20 | 0.10 |
| 11 EICAS | 0.20 | 0.10 | 0.05 |
| 12 Datalink | 0.00 | 0.00 | 0.00 |
| 13 CDU | 0.20 | 0.00 | 0.03 |
| 14 EFB | 0.00 | 0.00 | 0.00 |
| 15 MCW | 0.20 | 0.00 | 0.03 |

Notes: ADI = Attitude Direction Indicator; Alt = Altitude; AOI = Area of Interest; CDU = Control Display Unit; EICAS = Engine Indicating and Crew Alert System; EFB = Electronic Flight Bag; FMA = Flight Mode Annunciator; HUD = Head-Up Display; MCW = Master Caution and Warning Light; MCP = Mode Control Panel; ND = Navigation Display; Spd = Speed; VS = Vertical Speed; OW = Out-the-Window.

Next, we manipulated the presence or absence of use of an electronic flight bag (EFB AOI in Figure 4.1). When in use, we assigned it a value parameter of 0.50 (making it less valuable than the aggregate of the primary flight display (PFD) cluster of the ADI, Speed, Altimeter and Vertical Situation Display (VSD), but more valuable than the OW view or the ND). When not in use, the value of the EFB was assigned to 0. Correspondingly the BW of the EFB was assigned a higher value (0.5) when in use, than when not (BW = 0). (Because the EFB is not a dynamic instrument in the same sense as other flight instruments, it is not easy to compute a true bandwidth for it; instead, we used the parameter to correspond to an information richness component; Horrey, Wickens, & Consalus, 2006).

We compared how use of the EFB would influence noticing time to events in three different AOIs: above the CDU, between the CDU and the DL (datalink) display, and OW. All events used the same salience of onset as that employed in the model runs 8-10 shown in Table 4.3. The miss rate data are shown in Table 4.5a. The mean noticing time data are shown in Table 4.5b.

Table 4.5a. Miss Rate Data with a NextGen Automated Cockpit on Approach with and without an EFB as a Function of Off-Nominal Event Location

| Off-Nominal Event Location | Miss Rate * | |
|----------------------------|-------------|------|
| | No EFB | EFB |
| CDU | 0.56 | 0.63 |
| Btn CDU and DL | 0.62 | 0.71 |
| OW | 0.44 | 0.51 |

Notes: CDU = Control Display Unit; EFB = Electronic Flight Bag; DL = Datalink display; OW = Out-the-Window.
 *Sigma = 100, Crit = 15.

Table 4.5b. Response Time Data with a NextGen Automated Cockpit on Approach with and without an EFB as a Function of Off-Nominal Event Location

| Off-Nominal Event Location | Noticing Time ** | |
|----------------------------|------------------|------|
| | No EFB | EFB |
| CDU | 2.95 | 2.75 |
| Btn CDU and DL | 2.9 | 3.15 |
| OW | 2.9 | 2.80 |

Notes: Represents runs 14- 19. CDU = Control Display Unit; EFB = Electronic Flight Bag; DL = Datalink display; OW = Out-the-Window.

** Seconds until detection @ 2 saccades/sec.

The data in Table 4.5a clearly indicate the increased miss rate associated with active use of the EFB (right column), an average increase of 7% (significant, given that 3% = 95% CI). It further indicates that the cost to noticing scales roughly with the distance from the active EFB; a smaller cost to noticing on the location at the CDU, than between the CDU and DL. The predicted response time data (response times for detected events) are slightly less consistent; although this mean generally increases when the EFB is in operation, and it is again, longest when the event occurs in the CDU.

4.6.2 NextGen Takeoff / Departure Scenarios

Here we focused on predicting off-nominal event responses in two earlier phases of flight, take-off (acceleration until wheels up) and departure. The parameters for take-off are shown in Table 4.6 (left) and for departure are shown in Table 4.6 (right). The take-off parameters were adopted from those providing the best fit to the Boeing data of Sarter et al. (2007) and of McCarley et al. (in preparation). Noteworthy in the left table is the very high attention predicted to be directed OW, as procedures mandate that the pilot flying (PF) maintain fixation there, while monitoring auditory call outs of velocity from the pilot not flying (PNF). Because engine parameters are particularly vital

during takeoff roll, we have increased the value of these parameters in the EICAS, relative to other runs; however this increase is not extensive for the PF; as it would be the PNF who must be responsible for monitoring head-down gauges. We note obviously that vertical information (altitude and vertical speed) have neither relevance nor bandwidth while the plane travels along the ground.

During departure, we did not have separate parameters available from our prior Boeing validation study. Hence we utilized the descent parameters from that study, with the one exception that the EICAS was assigned higher value, given the vital importance of power management during take-off.

The take-off scenario was run twice, first with the off-nominal event located on the EICAS (run 20), and again with the event located OW (run 21). The departure scenario was run with the off-nominal event OW (run 22) and again with the event located between the CDU and the lower EICAS (run 23).

Table 4.6. Parameter Values for Takeoff (left) and Departure (right) Scenarios

| Run 20 and 21: Take Off | | | Run 22 and 23: Departure | | |
|-------------------------|------------|------------|--------------------------|------------|------------|
| AOI # and location | Value | BW | AOI # and location | Value | BW |
| 1 Off-nominal event | 0.1 | 0.0 | 1 Off-nominal event | 0.1 | 0.0 |
| 2 OW | 0.9 | 0.6 | 2 OW | 0.3 | 0.4 |
| 3 HUD | 0.0 | 0.0 | 3 HUD | 0.0 | 0.0 |
| 4 MCP | 0.2 | 0.0 | 4 MCP | 0.2 | 0.0 |
| 5 Spd | 0.1 | 0.2 | 5 Spd | 0.3 | 0.2 |
| 6 FMA | 0.1 | 0.0 | 6 FMA | 0.1 | 0.0 |
| 7 ADI | 0.1 | 0.4 | 7 ADI | 0.6 | 0.8 |
| 8 Alt | 0.0 | 0.0 | 8 Alt | 0.4 | 0.3 |
| 9 VSD | 0.0 | 0.0 | 9 VSD | 0.6 | 0.4 |
| 10 ND | 0.0 | 0.0 | 10 ND | 0.4 | 0.2 |
| 11 EICAS | 0.2 | 0.2 | 11 EICAS | 0.3 | 0.2 |
| 12 Datalink | 0.0 | 0.0 | 12 Datalink | 0.0 | 0.0 |
| 13 CDU | 0.2 | 0.0 | 13 CDU | 0.2 | 0.0 |
| 14 EFB | 0.0 | 0.0 | 14 EFB | 0.0 | 0.0 |
| 15 MCW | 0.2 | 0.0 | 15 MCW | 0.2 | 0.0 |

Notes: ADI = Attitude Direction Indicator; Alt = Altitude; AOI = Area of Interest; CDU = Control Display Unit; EICAS = Engine Indicating and Crew Alert System; EFB = Electronic Flight Bag; FMA = Flight Mode Annunciator; HUD = Head-Up Display; MCW = Master Caution and Warning Light; MCP = Mode Control Panel; ND = Navigation Display; Spd = Speed; VS = Vertical Speed; OW = Out-the-Window.

The miss rate and noticing time data for these takeoff and departure scenarios are shown in Tables 4.7a and 4.7b, respectively.

Table 4.7a. Take-off and Departure Miss Rates as a Function of Event Location

| Off-Nominal Event Location | Takeoff | Departure |
|----------------------------|------------|-------------------|
| OW | 0.14 | 0.46 |
| Variable | EICAS 0.35 | Datalink/CDU 0.60 |

Notes: CDU = Control Display Unit; EICAS = Engine Indicating and Crew Alerting System; OW = Out-the-Window. Sigma = 100, Crit = 15.

Table 4.7b. Take-off and Departure Noticing Time as a Function of Event Location

| Off-Nominal Event Location | Takeoff* | Departure* |
|----------------------------|------------|-------------------|
| OW | 2.35 | 2.90 |
| Variable | EICAS 2.70 | Datalink/CDU 2.75 |

Notes: Represents Runs 20-23. CDU = Control Display Unit; EICAS = Engine Indicating and Crew Alerting System; OW = Out-the-Window.

*Seconds until detection @ 2 saccades/sec.

Focusing initially on the miss rate data during takeoff, these clearly indicate the benefit for noticing the OW event, which is missed only 14% of the time, given that the PF can is heavily driven to the forward view. (Detection performance is not perfect here, as might otherwise be predicted, because the salience of our OW event was low). The miss rate for a down event on the EICAS (of equivalent salience) was correspondingly increased to 0.35. During departure, when the pilot has a greater degree of responsibility for instrument monitoring, the miss rate for OW events increases dramatically, from 0.14 (take-off) to 0.46 (departure). The miss rate for events on the CDU or datalink display remains high, as might be expected from the layout of Figure 4.1, where, during departure, there is heavy monitoring of the primary flight instrument cluster considerably separated from the datalink/CDU event. The response times in Table 4.6b show a corresponding trend to those of the miss rate data, but are more muted in their magnitude.

4.6.3 NextGen Scenarios with Increased Pilot Self-Separation Responsibilities

A next set of model simulation runs addressed the increased visual demands of self separation responsibilities, mimicking concerns a decade ago for the added workload associated with “freeflight” (FF; Wickens, Helleberg, & Xu, 2002). Miss rate and NT are shown in Table 4.8 and b respectively. Note that in these scenarios the ND, assumed to host a CDTI, which will have both its BW and value greatly amplified. Here we increase the value parameter to 1.0, the maximum possible, given that the pilot has full and exclusive responsibility for self-separation. BW depends on the amount of traffic (e.g., density of the surrounding airspace), and this is varied from a low (BW = 0.4) to a high (BW = 0.8) traffic scenario (first two rows in Tables 4.8a and 4.8b). The next run (third row) is carried out in IMC, where (unlike all previous runs) the OW has neither BW (nothing can be seen there, so there is no visual change) nor value. Lastly, a pair of runs was conducted in which self-separation responsibility is time-shared with the need to deal with an engine failure, imposing a higher BW and value on the EICAS. This is shown in the fourth row of the table. Because we

assume that such fault management imposes a high cognitive load, as well as the higher visual load, we simulate the former by reducing the functional field of view in half ($\sigma = 100 \rightarrow \sigma = 50$) so that the fourth row (wider field of view) can be compared with the fifth (narrow) to examine the cognitive workload effects on noticing.

Table 4.8a. Self-separation Miss Rates

| Scenario | Miss Rate* |
|--|------------|
| Self-separation - low traffic | 0.50 |
| Self-separation - high traffic | 0.55 |
| Self-separation - high traffic, IMC | 0.62 |
| Self-separation - high traffic, IMC, engine failure | 0.64 |
| Self-separation – high traffic, IMC, engine failure, high cognitive load | 0.83 |

Notes: *Sigma = 100 in all but row 5, Crit = 15.

Table 4.8b. Self-Separation Noticing Times

| Scenario | Noticing Time (sec)** |
|--|-----------------------|
| Self-separation - low traffic | 3.00 |
| Self-separation - high traffic | 2.90 |
| Self-separation - high traffic, IMC | 3.00 |
| Self-separation - high traffic, IMC, engine failure | 3.00 |
| Self-separation – high traffic, IMC, engine failure, high cognitive load | 2.50 |

Notes: ** Seconds until detection @ 2 saccades/sec.

The miss rate data again follow intuition. First, imposing the responsibility of self-separation and CDTI monitoring can lead to missing approximately half of OW off-nominal events. (We are assuming here that the off-nominal misses are **not** aircraft depicted on the CDTI within the ND, but rather, represent the “rogue traffic” with a transponder turned off or that otherwise is not displayed on the CDTI; Wickens et al, 2002). Second, imposing greater traffic load has a modest impact on off-nominal detection. Third, in IMC, when the outside world is no longer considered relevant, detection of those few events that **can** be seen outside will be hindered still further. Fourth, imposing the visual demands of dealing with an engine failure has only a minimal effect on OW detection. This is because, in IMC, there is minimal scanning OW anyway, and so it is near a floor effect. Fourth, visual resources to process the EICAS display during fault management are borrowed from other nearby areas (e.g., altitude monitoring, speed monitoring, ADI). But finally, when **cognitive load** imposed by fault diagnosis is simulated by narrowing the field of view, a very pronounced penalty to detecting outside world events is imposed, with a miss rate of over 80%, the highest of any simulation run in this phase. We note in the right column of Table 4.8b, that the RT data do not track the miss rate data very accurately, and indeed, in the last row, those events that **are** detected, are actually depicted more rapidly than in the other conditions. Reasons for this disparity between miss rate and RT effects will be discussed below.

4.6.4 Very Closely Spaced Parallel Approaches

A related concept to the self separation responsibilities reported above, is the procedure for flying a very closely spaced parallel approach or NextGen’s VCSPA in low-visibility. Table 4.9 shows the parameter values that were coded for this procedure. Highlighted values are those of substantial difference from previous model runs.

Table 4.9. Very Closely Spaced Parallel Approaches (VCSPA) Parameters

| Model runs 29 & 30 | | |
|---------------------|-------------|-------------|
| AOI # & Location | Value | BW |
| 1 Off-Nominal Event | 0.10 | 0.00 |
| 2 OW | 0.10 | 0.00 |
| 3 HUD | 0.00 | 0.00 |
| 4 MCP | 0.20 | 0.10 |
| 5 Spd | 0.60 | 0.40 |
| 6 FMA | 0.10 | 0.10 |
| 7 ADI | 0.60 | 1.00 |
| 8 Alt | 0.80 | 0.60 |
| 9 VSD | 0.60 | 0.40 |
| 10 ND | 1.00 | 0.80 |
| 11 EICAS | 0.20 | 0.10 |
| 12 Datalink | 0.00 | 0.00 |
| 13 CDU | 0.20 | 0.00 |
| 14 EFB | 0.00 | 0.00 |
| 15 MCW | 0.20 | 0.00 |

Notes: ADI = Attitude Direction Indicator; Alt = Altitude; AOI = Area of Interest; BW = Bandwidth; CDU = Control Display Unit; EICAS = Engine Indicating and Crew Alert System; EFB = Electronic Flight Bag; FMA = Flight Mode Annunciator; HUD = Head-Up Display; MCW = Master Caution and Warning Light; MCP = Mode Control Panel; ND = Navigation Display; Spd = Speed; VS = Vertical Speed; OW = Out-the-Window.

While we were not able to precisely capture all of the display changes that would be adopted by this procedure, we have “proxied” these changes by substantially increasing (i.e., doubling) both the value and BW of the primary flight instruments (relative to the self-separation conditions) and increasing those on the ND as well. It is assumed (from Verma, Lozito, Kozon, Ballinger, & Resnik, 2008) that these will capture both the addition of a specialized longitudinal separation display, a relative vertical situation display, and also predictor elements on all displays that provide trend information (predictor displays are of inherently higher BW). The impact of this procedure on noticing time was modeled for noticing events on the ND itself (e.g., a traffic blunder) and on the EICAS (e.g., an engine problem). For these runs, the off-nominal events were of a non-salient variety (e.g., rather than the red or amber warnings examined during runs 11 and 12). The miss rate data are shown in Table 4.10a and the notice time data are shown in Table 4.10b.

Table 4.10a. Very Closely Spaced Parallel Approaches (VCSPA) Miss Rates

| Off-Nominal Event Location | Miss Rate* |
|----------------------------|------------|
| ND | 0.29 |
| EICAS | 0.58 |

Notes: EICAS = Engine Indicating and Crew Alert System; ND = Navigation Display; TBNE = To-be-Noticed-Event.
*Sigma = 100, Crit = 15.

Table 4.10b. Very Closely Spaced Parallel Approaches (VCSPA) Noticing Times

| Off-Nominal Event Location | Noticing Time** |
|----------------------------|-----------------|
| ND | 2.60 |
| EICAS | 2.85 |

Notes: Represents Model runs 29 & 30. EICAS = Engine Indicating and Crew Alert System; ND = Navigation Display.
** Seconds until detection @ 2 saccades/sec.

We note in Table 4.10a, the relatively low (but not 0) miss rate for events located immediately adjacent to the ND, a low value which could be expected, given the heavy visual demands of that display. But we also observe the remarkable doubling of miss rate for events on the EICAS, a display that is, in fact, adjacent to the ND, but on the opposite side from the primary instrument cluster which is also host of high visual demands during VCSPA. Noticing time also increases, but by a lesser amount.

4.6.5 Airborne Taxi Clearances

A final procedure examined was that in which a taxi clearance would be uploaded to the datalink display during descent (arrival), and the pilot would be required to both process this clearance and consult with the EFB about airport layout, runway status, runway exits, and to preview the taxi clearance. The model parameters that we ran for these three runs were essentially those of the EFB runs discussed in 3.6.1, Table 4.4, except that both the EFB and the datalink display were now given high values ($V = 0.50$) and high bandwidths ($BW = 0.50$) simulating the heavy head-down demands. As with the runs reported in Table 4.5 examining the EFB alone, here we again compared noticing time for non-salient events in (a) OW, (b) ND, and (c) Datalink. The miss rate data for these runs (31-33) are shown in Table 4.11a and the Noticing Times data are in Table 4.11b.

Table 4.11a. Airborne Taxi Clearance Miss Rates

| Off-Nominal Event Location | Miss Rate* |
|----------------------------|------------|
| OW | 0.41 |
| ND | 0.45 |
| Datalink | 0.57 |

Notes: ND = Navigation Display; OW = Out the Window
* Sigma = 100, Crit = 15.

Table 4.11b. Airborne Taxi Clearance Noticing Times

| Off-Nominal Event Location | Noticing Time ** |
|----------------------------|------------------|
| OW | 2.90 |
| ND | 2.70 |
| Datalink | 3.10 |

Notes: Represents model runs 31 and 33. ND = Navigation Display; OW = Out the Window.

** Sec until detection @ 2 saccades/sec.

The data in Table 4.11a show, importantly, that it is detection in the most remote datalink display that is most hindered by the demands of taxi-clearance information (in both miss rate and NT). The reason is that, although some of that information is presented on that very same datalink display, visual attention is also heavily invested in the most remote location from the datalink display, the EFB (see Figure 4.1). Detection of events located either between the two (ND) or above, but close to the “latitude” of the high demand (OW) does not suffer as much.

4.7 Summary

The mean noticing time and miss rate for all runs for the validation, sensitivity analysis and prediction phases of this research are presented in Table 4.12. The table also outlines the scenario description and the off nominal-event.

Table 4.12. Mean Time and Miss Rate Master Summary of all Model Runs, Research Phase, Scenario and Off Nominal Event Description

| Run | Research Phase | Scenario Description | Off-Nominal Event Description | Mean Noticing Time (sec) | Miss Rate |
|-----|----------------------|---|---------------------------------------|--------------------------|-----------|
| 1 | Validation | GA - Final Approach - Low Expectancy | Non-salient, Gray, OW | 2.67 | 0.39 |
| 2 | Validation | GA - Final Approach - Med. Expectancy* | Non-salient, Gray, OW | 2.75 | 0.34 |
| 3 | Validation | GA - Final Approach - High Expectancy | Non-salient, Gray, OW | 2.71 | 0.29 |
| 4 | Validation | GA - Final Approach - With HITS | Non-salient, Gray, OW | 2.88 | 0.41 |
| 5 | Validation | GA - Final Approach - Without HITS | Non-salient, Gray, OW | 2.68 | 0.28 |
| 6 | Validation | GA - Final Approach - OW | Non-salient, Gray, OW | 2.71 | 0.29 |
| 7 | Validation | GA - Final Approach - Down | Non Salient, Gray, Down event | 2.71 | 0.48 |
| 8 | Sensitivity Analysis | GA - Final Approach | Non Salient, Gray, Btn CDU and DL | 2.91 | 0.57 |
| 9 | Sensitivity Analysis | GA - Final Approach | Non-Salient, Gray, above the CDU | 2.77 | 0.48 |
| 10 | Sensitivity Analysis | GA - Final Approach | Non-Salient, Gray, below the ADI | 2.61 | 0.22 |
| 11 | Sensitivity Analysis | GA - Final Approach | Medium Saliency, Amber, ADI | 2.41 | 0.18 |
| 12 | Sensitivity Analysis | GA - Final Approach | High Saliency, Red, ADI | 2.31 | 0.18 |
| 13 | Sensitivity Analysis | GA - Final Approach | Offset, ADI | 3.16 | 0.60 |
| 14 | NextGen Prediction | NextGen Approach with no EFB | Non Salient, Gray, Above CDU | 2.95 | 0.56 |
| 15 | NextGen Prediction | NextGen Approach with EFB | Non Salient, Gray, Above CDU | 2.75 | 0.63 |
| 16 | NextGen Prediction | NextGen Approach with no EFB | Non Salient, Gray, Btn CDU and DL | 2.90 | 0.62 |
| 17 | NextGen Prediction | NextGen Approach with EFB | Non Salient, Gray, Btn CDU and DL | 3.15 | 0.71 |
| 18 | NextGen Prediction | NextGen Approach with no EFB | Non-salient, Gray, OW | 2.90 | 0.44 |
| 19 | NextGen Prediction | NextGen Approach with EFB | Non-salient, Gray, OW | 2.80 | 0.51 |
| 20 | NextGen Prediction | NextGen Take-off | Non Salient, Gray, Below EICAS | 2.70 | 0.35 |
| 21 | NextGen Prediction | NextGen Take-off | Non-salient, Gray, OW | 2.35 | 0.14 |
| 22 | NextGen Prediction | NextGen Departure | Non-salient, Gray, OW | 2.90 | 0.46 |
| 23 | NextGen Prediction | NextGen Departure | Non Salient, Gray, Btn CDU and DL | 2.75 | 0.60 |
| 24 | NextGen Prediction | NextGen Self-Separation - low traf | Non-salient, Gray, OW | 3.00 | 0.50 |
| 25 | NextGen Prediction | NextGen Self-Separation - high traf | Non-salient, Gray, OW | 2.90 | 0.55 |
| 26 | NextGen Prediction | NextGen Self-Separation - high traf IMC | Non-salient, Gray, OW | 3.00 | 0.62 |
| 27 | NextGen Prediction | NextGen Self-Separation - high traf IMC engine failure | Non-salient, Gray, OW | 3.00 | 0.64 |
| 28 | NextGen Prediction | NextGen Self-Separation - high traf IMC engine failure, hi cog load | Non-salient, Gray, OW | 2.50 | 0.83 |
| 29 | NextGen Prediction | NextGen VCSPA | Non-salient, Gray, Right of ND | 2.60 | 0.29 |
| 30 | NextGen Prediction | NextGen VCSPA | Non-salient, Gray, Right of EICAS | 2.85 | 0.58 |
| 31 | NextGen Prediction | NextGen Airborne Taxi Clearance | Non-salient, Gray, Below the ADI | 2.90 | 0.41 |
| 32 | NextGen Prediction | NextGen Airborne Taxi Clearance | Non-salient, Gray, Btn the CDU and DL | 2.70 | 0.45 |
| 33 | NextGen Prediction | NextGen Airborne Taxi Clearance | Non Salient, Gray, OW | 3.10 | 0.57 |

* not reported

Note that all OW events were placed slightly above the AOI due to a constraint of overlapping windows.

All ADI events were placed slightly below the ADI due to a constraint of overlapping windows

4.8 Discussion

The research effort represented the culmination of a series of sub-phases. First, over the last eight years, the SEEV model has been developed to capture cockpit scanning as driven by salience and effort (bottom up processes) and expectancy and value (top down processes; Wickens et al., 2003; Wickens et al., 2008). However in these efforts, the emphasis of salience was on the salience of an AOI rather than the salience of an event. The *N-SEEV model* was thus developed to satisfy this goal of *modeling event salience*; originally in a NASA project to design and evaluate wake vortex displays (Wickens et al., 2007), and then with subsequent refinements, and more accurate psychological modeling of event salience carried out by McCarley et al. (in preparation), where the most extensive validation of N-SEEV was carried out on a fairly basic visual simulation of FMS event noticing. Then, in the current project, we further refined and applied this model to predict scanning and noticing time within a full cockpit layout illustrated in Figure 4.1.

There are several parameters in the model. Most of these were “frozen” to accurately capture existing cockpit scanning data in the model simulations carried out by McCarley et al. (in preparation), and these fixed values were employed in the current effort. One particular parameter was adjusted and then frozen in the current effort; the setting of the speed accuracy tradeoff, by establishing the number of ½ second fixations that occurred until a “miss” was declared to have occurred (this criterion was set to 15). Finally, other parameters, particularly those associated with BW and value of display AOIs and off-nominal event location were adjusted repeatedly across the model runs of the current effort, to capture properties of each flight deck simulation. These two issues: adjusting the speed-accuracy criterion, and setting value and BW, will be discussed in further detail below.

A series of 33 model runs was then undertaken, and these can be associated with a smaller set of clusters. In all of these runs, percent dwell time (attentional interest) data was generated by the model; however we focus in this discussion exclusively on the noticing data.

The first cluster of model runs (1-7) were **validation runs**, which provided the vital link between Phase 2 (the meta-analysis) and Phase 3. (One of these rows was not used for validation because its bandwidth value – 0.10 – was replaced with 0.20). Here, as shown in Figure 4.3, we demonstrated that the model predicted the existing miss rate data from three robust effects that were observed in the meta-analysis (expectancy effect, location effect, and HITS effect). While one might wish for a higher correlation than the value of 0.72, this value is certainly adequate (50% of variance accounted for), given the great diversity of studies that generated the empirical data and the imprecision with which we were able to capture the set of cockpit layouts and procedures that contributed to a particular data point in the observed miss rate data. In support of the adequacy of model predictions, we note that all of the six empirical data points were predicted within 15% (on an absolute scale; that is, for example 55% observed, 40% predicted). Furthermore, three of the data points were predicted within 5%.

The second cluster (runs 8-13) examined key aspects of noticing time determined by salience properties of the event itself (rather than properties of the scenario or display layout). This cluster consisted of a **sensitivity analysis** rather than a validation, because we did not have available any empirical miss rate data corresponding to the parameters varied (but see McCarley et al., in preparation). Thus, our focus was to establish if miss rate varied in a magnitude and direction that

was to be expected as event eccentricity and salience were varied. Indeed these model effects were observed (see Table 4.3). Moving events closer to the center of visual action reduced miss rate, as did making them more salient (red, amber onsets); while making them less salient (offsets) increased miss rate. Indeed the only puzzling aspect of these data was the lack of a difference in miss rate (or NT) between amber and red alerts, in spite of the model-set higher pertinence values assigned to red (than amber).

The third cluster of model runs (14-32), which we label **prediction runs** involved a series of sub-clusters predicting effects on miss rate and NT of various proposed procedures and display concepts associated with NextGen operations. Specifically, we examined:

- NextGen Approaches with and without an EFB as event location varied
- Take-off and departure scenarios
- Self-separation responsibilities and engine failure
- Very closely spaced parallel approaches
- Uplinked taxi clearances during approach

The results from these runs are all reported in the previous section, and all continued to provide reasonable estimates of miss rate differences between procedures, and between different locations of off-nominal events.

We have discussed two important and interrelated issues here – the performance of pilots detecting very unusual events, and the ability of a psychologically based computational model to predict such detection. Regarding the first of these, our meta-analyses revealed substantial performance decrements, with miss rate averaged across conditions of 32%. On the one hand, such a level of performance might well be considered disconcerting for aviation safety. But on the other hand, such misses will occur quite infrequently, since the base rate of these off-nominal black swan events is, by definition, exceedingly low (but not impossible). Furthermore, the results from these high-fidelity flight simulations certainly replicate what is now well-known regarding change blindness and inattentive blindness in the real world (Rensink, 2002; Simons & Levin, 1997; Sarter Mummaw and Wickens, 2007; Stelzer & Wickens, 2007; Wickens & Alexander, 2009; Wickens Thomas & Young, 2000). That is, people simply do a poor job of noticing changes (events) when (a) these are unexpected (b) they are not salient and (c) they occur outside of foveal vision; all conditions that typified the events analyzed in our meta-analysis.

4.9 Future Research

On the basis of our overall experience during Phase 3, several additional observations can be made, as follows.

4.9.1 Parameter Setting

Our model exercise could be criticized on two grounds related to how we chose the parameters. First, there were a large number of “free parameters” in the model, and such models can often be criticized on the grounds that, with enough free parameters, one can fit any data set. In defense of

our model complexity, we note first that all parameters have solid psychological justification, linked directly to theories of attention and to a great deal of experimental research. Furthermore the levels of these parameters that were “frozen” in McCarley et al. (in preparation) were not arbitrary, but themselves based on a combination of plausibility and fit with their data sets, which were independent of the data sets used here.

A second criticism could be offered toward what might be perceived as arbitrary settings of bandwidth and value for the 15 AOIs across the 33 model runs. Here we note that several non-arbitrary rules for such settings were presented in Wickens et al. (2003) and Wickens et al. (2008), and the modeler for the current data (CDW) made efforts to adhere to those rules (e.g., displays supporting aviating of higher value than displays supporting navigating; displays of inner loop flight dynamics having higher bandwidth than those supporting outer loop dynamics, outside world in IMC having 0 bandwidth etc.). However in several instances assumptions needed to be made (e.g., how valuable the outside world was to certain tasks, or what the bandwidth was on the EFB when it was consulted). Ideally, each model run should be accompanied by a sensitivity analysis, where the parameters for every such uncertain AOI would be varied across a wide range, to establish the extent to which such variation influenced model predictions. Obviously time constraints prevented us from doing so. However in future applications that may be targeted extensively on a single procedure (e.g., VCSPA), this can be done.

4.9.2 Speed – Accuracy Tradeoff: Noticing Time vs. Miss Rate

Three factors led us to focus more on miss rate than on noticing time as the key predicted variable. First, most of the meta-analysis data reported miss rate (rather than noticing time), so it made sense to use this as the variable for validation. Second, the model, (and real data, when available) typically represents noticing time in a highly skewed fashion, with a long tail of long noticing times. This means that accurately capturing a single measure of central tendency of noticing time (which could be used for validation) is difficult, and often quite arbitrary. Third, it is evident that because many events **are** missed in simulations (and real world flight), pilots’ behavior is governed by some implicit criterion such that an event, not noticed by a certain time, will not be noticed at all. This of course was operationalized by the ‘Crit’ parameter (15 saccades) that we imposed. Our selection of this particular value for ‘Crit’ was based on iterations done both here (in the validation model runs) and in McCarley et al. (in preparation) and these iterations revealed that this criterion of 15 provided the best fit to existing data. Hence it was chosen, and as we note, its value supports reasonably good predictions.

Of course the role of noticing time in the model should not be discounted. There are certainly many time-critical situations where prediction of noticing time is as critical as that of miss rate (e.g., noticing an engine failure during takeoff roll). These are typically circumstances when the event is sufficiently salient that it will always be noticed within 15 saccades. In the current data, we did not impose such high salience as to drive miss rate to 0 and thereby cast all variance into noticing time. However it will be important for the model to be exercised for such scenarios in the future.

4.9.3 Single Pilot Modeling

One of the most important constraints of the current approach is that we only modeled event noticing by a single pilot. Clearly in many NextGen applications, there will be “two sets of eyes” in the cockpit, offering some redundancy. One approach to this complexity would be to simply predict the miss rates for both pilots as the square of the miss rate for the single pilot. (e.g., miss rate for one pilot = 0.50; miss rate for both = 0.25). The problem with this approach is that it assumes independence of scanning between the two. Yet cockpit procedures typically dictate very different and hence non-independent monitoring roles for PF and PNF (e.g., during takeoff roll). These issues remain to be examined.

4.9.4 Separate Effect of Effort

One characteristic of the current implementation of the N-SEEV model is that it does not have a separate component to characterize the effort of moving attention over greater distances. Two factors underlie this current decision. First, the loss of salience at greater eccentricities acts as sort of a proxy for effort, since it means that more peripheral events are less likely to capture attention, just as more peripheral events are less likely (for effort conservation reasons) to be part of the scanning sequence. Second, observation in our simulations with pilots (Wickens et al., 2008) reveal that this particular population is not heavily “effort-constrained” in their flight deck scanning, so that incorporating such a component for predicting pilot scanning would be unnecessary. Nevertheless it is our anticipation that future generations of N-SEEV will contain an effort parameter that is separate and independent from salience.

4.9.5 Visual Attention Only

N-SEEV is a model of visual noticing time and visual scanning, and does not (yet) encompass auditory inputs nor higher-level cognition (e.g., diagnosis, rather than detection). With regard to inter-modality noticing, there is no intrinsic reason why the salience of auditory events cannot be expressed on a common scale with visual event salience to address the noticing of auditory warnings as well (see Wickens et al., 2008; Application 1). Some data in cross modality monitoring exist to help provide validation for such a cross-modal scale in future research.

With regard to higher-level cognition, we note two things. First, N-SEEV is not intended to be a model of processes such as diagnosis, situation awareness or choice. It only feeds inputs to those higher level processes. Indeed in Wickens et al. (2008) we show how SEEV can integrate with a situation awareness model, and the effort toward such integration is currently underway in the context of the MIDAS human performance model at NASA (Hooey, Gore, Scott-Nash, Wickens, Small, & Foyle, 2008). Second, we were encouraged by observing how the manipulation of **cognitive load** associated with engine failure trouble shooting, as represented by the shrinking of the visual field of view (run 29) could produce very plausible effects on miss rate. In future research, we will also examine how well this FOV parameter can capture other effects of cognitive load on visual attention.

CHAPTER 5. CONCLUSION

Each phase of the current NRA has produced results that are expected to be useful for NASA in the development of human performance models, such as those using the Man-machine Integration Design and Analysis System v5 (MIDAS v5)¹¹ or other modeling tools, and for developing HITL simulations).

5.1 Current-Day and NextGen Task Analyses for Approach and Departure

Phase 1 (See Chapter 2) yielded fine-grained task analyses in sufficient detail to produce baseline human performance models of current-day, nominal operations for both approach and departure. These task analyses were developed in conjunction with researchers who possess expertise with human performance modeling, and as such are at a level of granularity and format that can be immediately used by NASA in their modeling efforts. Additionally, typical NextGen arrival and departure scenarios at a higher level of detail were generated. It is anticipated that NASA will use these NextGen task analyses in future HPM and HITL efforts to define and evaluate ASDO concepts by outlining the human roles and responsibilities, tasks, and procedures.¹²

5.2 Identification of Off-Nominal Scenarios for NextGen ASDO Operations

Phase 1 (see Chapter 2) also resulted in the identification of a set of off-nominal events for NextGen ASDO environments. The project team reviewed relevant literature, interviewed pilot and air traffic control (ATC) subject matter experts (SMEs), interviewed concept developers and NextGen researchers from NASA and industry, and conducted a scenario-based focus group session with commercial pilots. To define the off-nominal events, a systematic approach was adopted that included four human-system interaction issues: environment (e.g., weather, terrain), system (e.g., interactions with ATC, other pilots), human (e.g., error) and machine (e.g., partial and full system failures). This process culminated in 13 off-nominal events on arrival and 8 off-nominal events on departure. It is expected that these off-nominal events may be of use to NASA, the FAA, and industry partners to guide future research efforts and scenario development efforts for both HPMs and HITL studies. Further, it is believed that the identification of these off-nominal events will contribute to concept development efforts by identifying potential problem areas that are better addressed early in the design and development phase.

5.3 Comprehensive Data Set of Human Performance Responses to Off-Nominal Events

Phase 2 (see Chapter 3) of the research effort extracted and extrapolated data that characterizes pilot performance during off-nominal events from existing human-in-the-loop (HITL) studies. Phase 2

¹¹ For a discussion of MIDAS v5, the reader is directed to Gore, Hooley, Scott-Nash, & Foyle (2008) and to the MIDAS website <http://hsi.arc.nasa.gov/groups/midas/>; or contact MIDAS Technical POC Brian Gore.

¹² This supports Milestone AS 2.6.05 (Identify user information & decision support needs for sequencing, merging, & spacing); Milestone AS 2.6.07 (Develop procedures & technologies for initial ASDO CONOPS).

results provided an understanding of how noticing probability (P(notice)) and noticing time (NT) are influenced by important variables such as pilot expectancy and event location, and how these expectancy-location functions are moderated by other factors, such as presence or absence of various flight deck technologies and display formats. This meta-analysis produced estimates of the effect of each factor, and interactions among relevant factors, on event miss rates and response latency.

In addition to being used in Phase 3 of this research effort to validate the N-SEEV model, it is expected that these data will be directly used by NASA in two ways:

- a) As inputs into the model.
For example: a model could require as an input an event detection rate which, for many variables and scenarios, can be directly accessed from the tables presented in Phase 2 (Chapter 3).
- b) To verify and validate model output
For example: a model, if run in Monte Carlo mode, could produce a probability of detection. These probabilities could be compared to the objective miss rates as computed and presented in Phase 2 (Chapter 3).

5.4 Validated N-SEEV Model

An important contribution of the present research was in the efforts undertaken to refine, and validate the N-SEEV model. Not only did the present research realize the goals of developing and refining a computational model (N-SEEV) to predict response parameters for off-nominal events, but the team was able to successfully validate the N-SEEV model by comparing output to meta-analysis data. To bolster this validation effort, a sensitivity analysis of the N-SEEV model to provide miss rates as a function of event eccentricity and event salience was completed and the validated N-SEEV model was then used to predict pilot responses to future NextGen scenarios. The software will be available to NASA to be used as a standalone package to quickly make predictions about human attention demands of NextGen concepts.¹³

In addition, N-SEEV was developed with the criteria that it be easily integrated into NASA's MIDAS software (although the actual software integration was beyond the scope of this research effort). MIDAS already contains the SEEV sub-model, and thus can easily be augmented to incorporate the newly validated, N-SEEV model. It is anticipated that the newly refined N-SEEV model will enable more accurate predictions to be generated from the MIDAS software.

5.5 Performance Predictions for NextGen Scenarios

In Chapter 4, the N-SEEV model was exercised to make predictions about pilot performance in NextGen scenarios including:

- a. ASDO Approaches with and without an EFB

¹³ N-SEEV is available through coordination with NASA POC (Dr. Jeffrey Mulligan) on NRA topic IIFDT-3.3: Attention Directing, Individual and Ambient Characteristics.

- b. Take-off and Departures
- c. Self-separation
- d. VCSPA
- e. Airborne Taxi Clearances

The probability of missing an event and noticing times for these scenarios were provide in Chapter 4¹⁴.

5.6 Research Methods to Predict the Unpredictable

A common problem facing all researchers involved in the design and development of NextGen Operations is how to develop adequate research processes and methods to test and evaluate systems that do not yet exist. One important product of the current research is the structured approach that was used to explore human performance responses to current off-nominal events and use this to predict responses to future off-nominal events. This three-phased research effort represents a method that may be useful if replicated and extended to other problems within NASA, the FAA, or industry.

5.7 Summary

It is anticipated that the results from this research will be useful for NASA to develop more credible predictive human performance models using NASA's MIDAS v5 architecture. Armed with realistic NextGen scenarios (Phase 1), valid input data (Phase 2), and a valid N-SEEV model (Phase 3), NASA is in a better position to model pilot attention and predict noticing times to off-nominal events in NextGen scenarios. Specifically, it is expected that MIDAS will now be better-suited to support the following important concept design and development research questions:

- a) **Concept Design.** Is this a plausible concept? Can the human operator reasonably be expected to carry out the required tasks? Are there periods of extreme high workload spikes followed by long periods of low workload?
- b) **Information Presentation.** Where should information be presented? Is the alert/notification salient enough to attract the pilots' attention in a timely manner? Is the pilot likely to notice the presence/absence of information in a timely manner? Is Display Design A better/safer/more efficient than Display Design B? What information should be presented aurally rather than visually? If information is presented in a non-central location, or in a central location during high workload, high clutter, and low salience conditions, it could be missed.

¹⁴ This supports Milestone AS 2.6.07 (Develop procedures and technologies for initial ASDO CONOPS); Milestone AS 1.6.01 (Characterize and quantify the uncertainty impact of ASDO procedures).

- c) **Operator Roles and Responsibilities.** Does this concept draw the pilots' attention to a display at a time when it is more important to attend elsewhere such as OW? Does the addition of new tasks into the cockpit alter the miss rate or noticing time for OW events?
- d) **Function Allocation** – Should this task be completed by the automation or the human operator? If the pilot is responsible for a task, is it likely that the miss-rate or time to notice an event will be unacceptable?
- e) **Coordinated SA** - What information and information format increase the probability of noticing an event or reduce the time to notice the event?

5.8 Final Words

In sum, this multi-phased research effort leveraging current and future operational requirements, existing empirical literature, and predictive modeling has provided NASA with a refined approach to generate predictions of NextGen concepts grounded in empirical human attention processes. Additionally, this research effort will be useful to the research field outside of NASA through the three professional publications that have already been generated from this research (listed in Appendix K).

CHAPTER 6. REFERENCES

- Alexander, A. L., & Wickens, C. D. (2005). *3D navigation and integrated hazard display in advanced avionics: Performance, situation awareness, and workload* (Technical Report AHFD-05-10/NASA-05-2). Savoy, IL: Aviation Human Factors Division.
- Alexander, A. L., Wickens, C. D., & Hardy, T. J. (2005). Synthetic vision and the primary flight display. *Human Factors*, *47*, 693-707.
- Arthur, J., Prinzel, L. J., Bailey, R. E., Shelton, K. J., Williams, S. P., Kramer, L. J., & Norman, R. M. (2008). *Head-worn display concepts for surface operations for commercial aircraft*. (NASA/TP-2008-215321). Hampton, VA: NASA.
- Arthur, J. J., Prinzel, L. J., Kramer, L. J., Parish, R. V., & Bailey, R. E. (2004). *Flight simulator evaluation of synthetic vision display concepts to prevent controlled flight in to terrain (CFIT)* (NASA/TP-2004-213008). Hampton, VA: NASA.
- Arthur, J. J., Prinzel, L. J., Williams, S. P., & Kramer, L. J. (2004). *Synthetic vision enhanced surface operations and flight procedures rehearsal tools* (NASA/TP-2004-213008). Hampton, VA: NASA.
- Bailey, R. E., Kramer, L. J., & Prinzel, L. J. (2006). Crew and display concepts evaluation for synthetic enhanced vision systems. *Proceedings of SPIE*, vol. 6226.
- Beringer, D. B., & Harris, H. C. (1999). Automation in general aviation: Two studies of pilot responses to autopilot malfunctions. *The International Journal of Aviation Psychology*, *9*(2), 155-174.
- Boeing Commercial Airplanes. (2007). *Statistical summary of commercial jet airplane accidents*. Boeing Commercial Airplanes Aviation Safety: Seattle WA. Available at: <http://www.boeing.com/news/techissues/pdf/statsum.pdf>
- Burian, B. K. (2008). Perturbing the system: Emergency and off-nominal situations under NextGen. *International Journal of Applied Aviation Studies*, *8*(1), 114-127.
- Carriker, M. (2006). *Boeing 787 Dreamliner flight deck safety, comfort, efficiency*. Boeing Commercial Airplanes. Available at <http://www.rupa63.org/Boeing787Cockpit.pdf>
- Casner, S. (2001). *The Pilot's Guide to the Modern Airline Cockpit*. Ames, Iowa: Iowa State University Press.
- Degani, A., Mitchell, C. M., & Chappel, A. R. (1995). Task models to guide analysis: use of the operator function model to represent mode transition, *Proceedings of the Eighth International Symposium on Aviation Psychology*. OH: The Ohio State University Press.
- Earing, R. M. (1978). *The effects of expectancy and training on adaptation and detection of abrupt transition in control order*. Unpublished master's thesis, University of Illinois at Urbana-Champaign, Illinois.

- Fadden, S., Ververs, P. M., & Wickens, C. D. (2001). Pathway HUDS: Are they viable? *Human Factors*, 43, 173-193.
- Fischer, E., Haines, R. F., & Price, T. A. (1980). *Cognitive issues in head-up displays* (NASA Technical Paper 1711). Moffett Field, CA: NASA Ames Research Center.
- Fitts, P. M., & Posner, M. I. (1967). *Learning and skilled performance in human performance*. Belmont CA: Brock-Cole.
- Foyle, D. C., & Hooley, B. L. (2003). Improving evaluation and system design through the use of off-nominal testing: A methodology for scenario development. *Proceedings of the Twelfth International Symposium on Aviation Psychology*, 397-402. Dayton, Ohio: Wright State University.
- Foyle, D. C., Hooley, B. L., & Gore, B. F. (2007). *Shared awareness: Human performance model-based design tools*. Presented at the 1st Annual NASA Aviation Safety Conference. (October 10 – 12), St. Louis, MO.
- Foyle, D. C., Hooley, B. L., Wilson, J. R. & Johnson, W. A. (2002). HUD symbology for surface operations: Command guidance vs. situation guidance formats. *SAE Transactions: Journal of Aerospace*, 111, 647-658.
- Gore, B. F., & Jarvis, P. A. (2005). *New integrated modeling capabilities: MIDAS' recent behavioral enhancements*. Eighth Proceeding of the Annual SAE International Conference and Exposition - Digital Human Modeling for Design and Engineering, SAE Paper #2005-01-2701, Warrendale: USA, June.
- Gore, B.F. & Smith, J.D. (2006). Risk assessment and human performance modeling: the need for an integrated approach. In K.A. Malek (Ed.) *International Journal of Human Factors of Modeling and Simulation*, 1(1), 119-139.
- Hardy, G.H. & Lewis, E.K. (2004). Cockpit display of traffic and wake information for closely spaced parallel approaches. *AIAA Guidance, Navigation, and Control Conference and Exhibit* (2004-5106). Providence, RI.
- Hayes, W. L. (1981). *Statistics* (3rd ed). NY: CBS College publishing Co.
- Helleberg, J. (2005). *Effects of a final approach runway occupancy signal (FAROS) on pilots' flight path tracking, traffic detection, and air traffic control communications*. McLean, VA: The MITRE Corporation.
- Hofer, E. F., Braune, R. J., Boucek, G. P., & Pfaff, T. A. (2001). *Attention switching between near and far domains: An exploratory study of pilots' attention switching with head-up and head-down* (D6-36668). The Boeing Company, October 18, 2001

- Hoffman, E., Lehmann, O., Pene, N., Putz, T., Rognin, L., Trzmiel, A., & Zeghal, K. (2005). Assessing the impact of varied speed profiles on airborne spacing in a full flight simulator. *AIAA 5th Aviation Technology, Integration and Operations Conference*. 28 Sept. Arlington, VA (American Institute of Aeronautics and Astronautics).
- Honeywell (2010). Honeywell Aerospace SmartRunway™ and SmartLanding™ (2004-2010), retrieved 10/22/10 from <http://www51.honeywell.com/aero/Products-Services/Avionics-Electronics/Egpws-Home3/raas.html?c=21>
- Hooey, B. L., Foyle, D. C., & Andre, A. D. (2000). Integration of cockpit displays for surface operations: The final stage of a human-centered design approach. *SAE Transactions: Journal of Aerospace*, 109, 1053-1065.
- Hooey, B. L., Gore, B. F., Scott-Nash, S., Wickens, C. D., Small, R., & Foyle, D. C. (2008). *Developing the coordinated situation awareness toolkit (CSATK): Situation awareness model augmentation and application* (Technical Report HCSL-08-01). Moffett Field, CA: NASA Ames Research Center.
- Horrey, W. J., Wickens, C. D., & Consalus, K. P. (2006). Modeling drivers' visual attention allocation while interacting with in-vehicle technologies. *Journal of Experimental Psychology: Applied*, 12(2), 67-78.
- Iani, C., & Wickens, C. D. (2007). Factors affecting task management in aviation. *Human Factors*, 49, 16-24.
- Isaacson, D. (2007). *Airspace Super Density Operations (ASDO) Concept of Operations*, Version 1.0 (September 30, 2007). Moffett Field, CA: NASA Ames Research Center.
- Itti, L., & Koch, C. (2000). A saliency-based search mechanism for overt and covert shifts of visual attention. *Vision Research*, 40(10-12), 1489-1506.
- Johnson, N. R., Wiegmann, D. A., & Wickens, C. D. (2005). *Effects of advanced cockpit displays on general aviation pilots' decisions to continue visual flight rules (VFR) flight into instrument meteorological conditions (IMC)* (AFHD-05-18/NASA-05-6). Savoy, IL: University of Illinois, Aviation Human Factors Division.
- Jones, D. G., & Endsley, M. R. (1996). Sources of situation awareness errors in aviation. *Aviation, Space, Environmental Medicine*, 67(6), 507-512.
- Joint Planning and Development Office (JPDO). (2007). *Concept of operations for the next generation air transportation system*. Version 2.0, 13 June 2007. Washington, D.C.: FAA.
- Keller, J., Leiden, K. & Small, R. (2003). Cognitive task analysis of commercial jet aircraft pilots during instrument approaches for baseline and synthetic vision displays. In D.C. Foyle, A. Goodman & B.L. Hooey (Eds.), *Proceedings of the 2003 Conference on Human*

- Performance Modeling of Approach and Landing with Augmented Displays*, (NASA/CP-2003-212267), 15-69. Moffett Field, CA: NASA.
- Kirwan, B. & Ainsworth, L.K. (1992). *A Guide to Task Analysis*. Bristol, PA: Taylor & Francis Inc.
- Kramer, L., Bailey R., & Prinzel, L. (2009). Crew decision-making using fused synthetic / enhanced vision. *The International Journal of Aviation Psychology*, Volume [19](#), Issue [2](#) April 2009, pages 131 – 157.
- Latorella, K. A. (1998). Effects of modality on interrupted flight deck performance: Implications for datalink. *Proceedings of the Human Factors and Ergonomics Society 42nd Annual Meeting*, 42, 87-91.
- Lorenz, B., & Biella, M. (2006). Evaluation of onboard taxi guidance support on pilot performance in airport surface navigation. *Proceedings of the Human Factors and Ergonomics Society 50th Annual Meeting*, 111-115.
- McCarley, J. M., Wickens, C. D., Steelman, K., & Sebok, A. (in preparation). Control of attention: Modeling the effects of stimulus characteristics, task demands, and individual differences. *NASA Final Report, ROA 2007, NRA NNX07AV97A*.
- Miller, M.E., Dougherty, S., Stella, J., & Reddy, P. (2005). CNS requirements for precision flight in advanced terminal airspace. *Aerospace Conference, 2005 IEEE*, Big Sky, MO, USA.
- Mosier, K. L., Skitka, L. J., Heers, S., & Burdick, M. (1998). Automation bias: Decision making and performance in high-tech cockpits. *The International Journal of Aviation Psychology*, 8(1), 47-63.
- Mumaw, R., Sarter, N., Wickens C. D., Kimball, S., Nikolic, M., Marsh, R., Xu, W., & Xu, X. (2000). *Analysis of pilots' monitoring and performance on highly automated flight decks* (NASA Ames Final Project Report). Moffett Field, CA: NASA Ames Research Center.
- Nakao, M. (1994). *China airlines airbus A300-600R (Flight 140) misses landing and goes up in flame at Nagoya airport* (April 26, 1994), retrieved 11/08 from <http://shippai.jst.go.jp/en/Detail?fn=2&id=CA1000621>
- National Aeronautics and Space Administration Super Density Operations (NASA SDO). (2007, Fall). Program Description. Retrieved 10/3/07 from <http://nasaresearchers.nasaprs.com/research/detail.cfm?oppID=739>
- National Transportation Safety Board (NTSB) (2006). *Safety Recommendation: A-06-44 through – 47*. NTSB: Washington.

- Nikolic, M. I., Orr, J. M., & Sarter, N. B. (2004). Why Pilots Miss the Green Box: How Display Context Undermines Attention Capture. *The International Journal of Aviation Psychology*, 14(1), 39–52.
- Newman, R. L., McKay, D. E., Guirguis, M., & Zhang, R. (2002). (2002). Use of enhanced vision sensors for approach hazard detection. In *Proceedings of the NATO RTO SCI and SET Symposium on Enhanced and Synthetic Vision Systems*, September 10-12, 2002, Ottawa, Canada.
- Olson, W. A., & Sarter, N. B. (2001). Management-by-consent in human-machine systems: When and why it breaks down. *Human Factors*, 43(2), 255-266.
- Parasuraman, R., Molloy, R., & Singh, I. L. (1993). Performance consequences of automation-induced complacency. *International Journal of Aviation Psychology*, 3(1), 1-23.
- Pew, R.W., Miller, D.C. & Fehrer, G.G. (1981). *Evaluation of proposed control room improvements through the analysis of critical operator decisions*. EPRI Report NP 1982. Palo Alto, CA: Electric Power Research Institute.
- Prinzel, L. J., Hughes, M. F., Arthur, J. J., Kramer, L. J., Glaab, L. J., Bailey, R. E., Parrish, R. V., & Uenking, M. D. (2003). Synthetic vision CFIT experiments for GA and commercial aircraft: A picture is worth a thousand lives. *Proceedings of the Human Factors and Ergonomics Society 47th Annual Meeting*, 164-168.
- Prinzel, L. J., Kramer, L. J., Arthur, J. J., Bailey, R. E., & Comstock, R. J., (2004). Comparison of head-up and head-down “highway in the sky” tunnel and guidance concepts for synthetic vision displays. *Proceedings of the Human Factors and Ergonomics Society 48th Annual Meeting*, 11-15.
- Prinzel, L. J., Kramer, L. J., & Bailey, R. (2007). *Going below minimums: The efficacy of display enhanced/synthetic vision fusion for go-around decisions during non-normal operations* (NASA/TP 20070018289). Hampton, VA: NASA.
- Prinzel, L. J., Kramer, L. J., Bailey, R. E., & Sweeters, J. L. (2005). Development and evaluation of 2-D and 3-D exocentric synthetic vision navigation display concepts for commercial aircraft. *Proceedings of SPIE*, 5802(207).
- Rensink, R. A. (2002). Change detection. *Annual Review of Psychology*, 53, 245-277.
- Ruffell-Smith, H. P. R. (1979). *A simulator study of the interaction of pilot workload with errors, vigilance, and decisions* (Technical Memorandum 78482). Moffett Field, CA: NASA.
- Sarter, N., & Woods, D. D. (2000). Team play with a powerful and independent agent: A full-mission simulation study. *Human Factors*, 42(3), 390-402.

- Sarter, N. B., Mumaw, R., & Wickens, C. D. (2007). Pilots Monitoring Strategies and Performance on Highly Automated Glass Cockpit Aircraft. *Human Factors*, 49(3), 347-357.
- Steltzer, E. M. & Wickens, C. D. (2006). Pilots strategically compensate for display enlargements in surveillance and flight control tasks. *Human Factors*, 48(1), 166-181.
- Stevens, S. M., Goldsmith, T. E., Johnson, P. D., & Moulton, J. B. (2007). *Skill decay on takeoffs as a result of varying degrees of expectancy*. Presented at the 14th International Symposium on Aviation Psychology, Dayton, OH.
- Stevens, S. M., Goldsmith, T. E., & Johnson, P. J. (2007). Performance differences on rejected takeoffs as a function of expectancy. *Proceedings of the Human Factors and Ergonomics Society 51st Annual Meeting*, 51, 80-84.
- Verma, S., Lozito, S., Kozon, T., Ballinger, D., & Resnik, H. (2008). Procedures for off-nominal cases: Very closely spaced parallel runway operations. In *Proceedings of the 27th Digital Avionics Systems Conference*, October 26-30, 2008.
- Weintraub, D. J., Haines, R. F., & Randle, R. (1985). Head-up Display (HUD) utility, II: Runway to HUD transitions monitoring eye focus and decision times. In *Proceedings of the 29th Annual Meeting of the Human Factors and Ergonomics Society*. Santa Monica: HFES.
- Wickens, C. D. (2001). Attention to safety and the psychology of surprise. *Proceedings of the 11th International Symposium on Aviation Psychology*. Columbus, OH.
- Wickens, C. D. (2005). Attentional tunneling and task management. *Proceedings of the 13th International Symposium on Aviation Psychology*. Wright-Patterson AFB, Dayton, OH.
- Wickens, C.D. & Alexander, A. L. (2009). Attentional tunneling and task management in synthetic vision displays. *International Journal of Aviation Psychology*, 19(2), 1-17.
- Wickens, C. D., Alexander, A. L., Thomas, L. C., Horrey, W. J., Nunes, A., Hardy, T. J., & Zheng, X. S. (2004). Traffic and flight guidance depiction on a synthetic vision system display: The effects of clutter on performance and visual attention allocation (Technical Report AHFD-04-10/NASA(HPM)-04-1). Savoy, IL: Aviation Human Factors Division.
- Wickens, C. D., Alexander, A. L., Thomas, L. C., Horrey, W. J., Nunes, A., Hardy, T. J., & Zheng, X. S. (2004). *Traffic and flight guidance depiction on a synthetic vision system display: The effects of clutter on performance and visual attention allocation* (Technical Report AHFD-04-10/NASA(HPM)-04-1). Savoy, IL: Aviation Human Factors Division.
- Wickens, C. D., & Dixon, S. R. (2007). The benefits of imperfect diagnostic automation: A synthesis of the literature. *Theoretical Issues in Ergonomics Science*, 8(3) 201-212.
- Wickens, C. D., Goh, J., Helleberg, J., Horrey, W., & Talleur, D. A. (2003). Attentional models of multi-task pilot performance using advanced display technology. *Human Factors*, 45(3), 360-380.

- Wickens, C. D., Helleberg, J., & Xu, X. (2002). Pilot maneuver choice and workload in free flight. *Human Factors*, 44(2), 171-188.
- Wickens, C. D., & Hollands, J. (2000). *Engineering Psychology & Human Performance*, 3rd Ed. Upper Saddle River, N.J.: Prentice Hall.
- Wickens, C. D., Levinthal, B., & Rice, S. (2008). Imperfect Reliability in Unmanned Air Vehicle Supervision and Control. In M. Barnes & F. Jentch (Eds.) *Unmanned Air Vehicles*.
- Wickens, C. D., & McCarley, J. M. (2008). *Applied Attention Theory*. Boca-Raton, FL: CRC Press, Taylor & Francis.
- Wickens, C. D., McCarley, J. S., Alexander, A., Thomas, L., Ambinder, M., & Zheng, S. (2008). Attention-situation awareness (A-SA) model of pilot error. In D. Foyle, & B. Hooey (Eds.) *Pilot Performance Models*. Lawrence Erlbaum.
- Wickens, C. D., Rice, S., Keller, D., Hughes, J., & Hutchins, S. (2008). *Addressing the alert problem in ATC Facilities: Final report (2008-10-2)*. Las Cruces, NM: New Mexico State University.
- Wickens, C. D., Sebok, A., Bzostek, J., Steelman-Allen, K., McCarley, J. & Sarter, N. (2009). NT-SEEV: A model of attention capture and noticing on the flight deck. In Proceedings of the 15th International Symposium for Aviation Psychology. Dayton, OH: Wright State University.
- Wickens, C. D., Sebok, A., Kamienski, J., & Bagnall, T. (2007). Modeling situation awareness supported by advanced flight deck displays. *Human Factors and Ergonomics Society Annual Meeting Proceedings*. Santa Monica, CA: HFES.
- Wiener, E. L. (1977). Controlled flight into terrain. Accidents. *Human Factors*, 19, 171-182).

Appendix A. Phase 1 Bibliography of Materials Relevant to NextGen Operations

- Andre, A.D., Foyle, D.C., & Hooey, B.L. (2007). *Airspace super density operations (ASDO) seamless transition information requirements and procedural integration: Gap analysis*. Human centered systems laboratory technical report (HCSL-07-04). Moffett Field, CA: NASA-Ames Research Center.
- ASRS (Aviation Safety Reporting System) Database Report Set (2007). *RNAV incidents* (update 3.0, January 23, 2007). Moffett Field, CA: NASA-Ames Research Center.
- Barhydt, R. & Adams, C.A. (2006). *Human factors considerations for performance-based navigation* (NASA/TM-2006-214531). Hampton, VA: NASA-Langley Research Center.
- Boeing Commercial Airplanes. (2007). *Statistical summary of commercial jet airplane accidents*. Boeing Commercial Airplanes Aviation Safety: Seattle WA. Available at: <http://www.boeing.com/news/techissues/pdf/statsum.pdf>
- Callantine, T.J. & Wong, J. Crew activity tracking system for security (CATS²). Unpublished presentation (date unknown). Moffett Field, CA: NASA-Ames Research Center.
- Casner, S. (2001). *The Pilot's Guide to the Modern Airline Cockpit*. Ames, Iowa: Iowa State University Press.
- Cheng, V.H.L. (2004). *Phase III capacity-increasing concept SOAR* (Surface Operation Automation Research) (Technical report OSS-0202-13). Palo Alto, CA: Optimal Synthesis Inc.
- Cheng, V.H.L., Signor, D.B., Smith, J.C., Stell, L., and Trott, G.A. (July 1, 2007). *Next-generation air transportation system (NGATS) system-level concept design (SLCD) airport / surface domain technical integration report* (Internal Draft). Moffett Field, CA: NASA.
- Concept of Operations for Oceanic Tailored Arrivals* (Draft). Available at http://www.nasa.gov/centers/ames/research/2006/conops_ota.html as document
- Coppenbarger, R. (2007). *Tailored oceanic arrivals: Concept overview & initial field trials*. Presentation delivered to the UC Aviation Environmental Symposium. San Francisco, CA.
- Cornell, B. (March 21, 2007). San Francisco tailored arrival trials – Boeing perspective (MPG96308-07_cornell.ppt). Boeing Management Company.
- Degani, A., Mitchell, C. M., & Chappel, A. R. (1995). Task models to guide analysis: use of the operator function model to represent mode transition, *Proceedings of the Eighth International Symposium on Aviation Psychology*. OH: The Ohio State University Press.
- Federal Aviation Administration. (2006). *Roadmap for performance based navigation: Evolution for area navigation (RNAV) and required navigation performance (RNP) capabilities 2006 – 2025*. Available at

http://www.faa.gov/about/office_org/headquarters_offices/avs/offices/afs/afs400/rnp/media/RNProadmap.pdf?CFID=46230095&CFTOKEN=eee5593b73c930f-478F3783-1372-4132-EDD0A2C5B87BC49B&jsessionid=4a307531c7e76f6b6b70

- Foyle, D. C., Andre, A. D., McCann, R. S., Wenzel, E. M., Begault, D., & Battiste, V. (1996). Taxiway navigation and situation awareness (T-NASA) system: Problem, design philosophy and description of an integrated display suite for low-visibility airport surface operations. *SAE Transactions: Journal of Aerospace*, 105, 1411-1418.
- Foyle, D.C., Andre, A.D., Hooley, B.L., & Gore, B.F. (Feb. 1, 2008). ASDO: Seamless transitions research. PowerPoint presentation at NASA Ames Research Center.
- Foyle, D. C. & Hooley, B. L. (2003). Improving evaluation and system design through the use of off-nominal testing: A methodology for scenario development. *Proceedings of the Twelfth International Symposium on Aviation Psychology*. 397-402. Dayton, Ohio: Wright State University.
- Foyle, D. C. & Hooley, B. L. (Eds.) (2008). *Human Performance Modeling in Aviation*. Boca Raton, FL: CRC Press/Taylor and Francis.
- Gore, B.F. & Smith, J.D. (2006). Risk assessment and human performance modeling: the need for an integrated approach. In K.A. Malek (Ed.) *International Journal of Human Factors of Modeling and Simulation*, 1(1), 119-139.
- Hardy, G.H. (2002). *Pursuit display review and extension to a civil tilt rotor flight director*. AIAA Guidance, Navigation, and Control Conference and Exhibit (AIAA 2002-4925). Monterey, CA.
- Hardy, G.H. & Lewis, E.K. (2004). Cockpit display of traffic and wake information for closely spaced parallel approaches. *AIAA Guidance, Navigation, and Control Conference and Exhibit* (2004-5106). Providence, RI.
- Harrison, M.J. (2006). ADS-X The NextGen approach for the next generation air transportation system (IEEE paper 1-4244-0378-2/06). In *Proceedings of the 25th Digital Avionics Systems Conference*. Alexandria, VA: Aviation Management Associates.
- Hinton, D., Koelling, J., & Madsen, M. (2007). *Next generation air transportation system (NGATS) air traffic management (ATM) – airportal project*. May 23, 2007. Washington, DC: NASA.
- Hoffman, E., Lehmann, O., Pene, N., Putz, T., Rognin, L., Trzmiel, A., & Zeghal, K. (2005). Assessing the impact of varied speed profiles on airborne spacing in a full flight simulator. *AIAA 5th Aviation Technology, Integration and Operations Conference*. 28 Sept. Arlington, VA (American Institute of Aeronautics and Astronautics).

- Hooey, B. L., Foyle, D. C., & Andre, A. D. (2000). Integration of cockpit displays for surface operations: The final stage of a human-centered design approach. *SAE Transactions: Journal of Aerospace*, 109, 1053-1065.
- Hooey, B. L., Foyle, D. C., Andre, A. D., & Parke, B. (2000). Integrating datalink and cockpit display technologies into current and future taxi operations. Proceedings of the *AIAA/IEEE/SAE 19th Digital Avionics System Conference*, 7.D.2-1 - 7.D.2-8. Philadelphia, PA.
- Hooey, B. L., Foyle, D. C., & Andre, A. D. (2002). A human-centered methodology for the design, evaluation, and integration of cockpit displays. In proceedings of the NATO RTO SCI and SET Symposium on Enhanced and Synthetic Vision Systems. September, 10-12, 2002. Ottawa, Canada.
- Hughes, D. (2006). FAA accelerates performance-based navigation, outlines mandates. *Aviation Week & Space Technology*. McGraw-Hill.
- Isaacson, D. (2007). *Airspace Super Density Operations (ASDO) Concept of Operations*, Version 1.0 (September 30, 2007). Moffett Field, CA: NASA Ames Research Center.
- Joint Planning and Development Office. (2007). *Concept of operations for the next generation air transportation system*. Version 2.0, 13 June 2007. Washington, D.C.: FAA.
- Jones, D.R. (1990). *Three input concepts for flight crew interaction with information presented on a large-screen electronic cockpit display* (NASA TM 4173). Hampton, VA: NASA-Langley Research Center.
- Jones, D.R. and Prinzel, L.J. III. (2006). Runway incursion prevention for general aviation operations. In *Proceedings of the 25th Digital Avionics Systems Conference*. Hampton, VA: NASA-Langley Research Center.
- Keller, J., Leiden, K. & Small, R. (2003). Cognitive task analysis of commercial jet aircraft pilots during instrument approaches for baseline and synthetic vision displays. In D.C. Foyle, A. Goodman & B.L. Hooey (Eds.), *Proceedings of the 2003 Conference on Human Performance Modeling of Approach and Landing with Augmented Displays*, (NASA/CP-2003-212267), 15-69. Moffett Field, CA: NASA.
- Kirwan, B. & Ainsworth, L.K. (1992). *A Guide to Task Analysis*. Bristol, PA: Taylor & Francis Inc.
- Kramer, L., Bailey R., & Prinzel, L. (2009) Crew decision-making using fused synthetic / enhanced vision. *The International Journal of Aviation Psychology*, Volume 19, Issue 2 April 2009 , pages 131 – 157.

- Krozel, J., Smith, P., Andre, A., Hoffman, B., Thompson, T., Yousefi, A., & Doble, N. NASA Next Generation Air Transportation System (NGATS). National Domain Technology Integration Report (June 30, 2007)
- Leiden, K., Keller, J., & French, J. (2002). Information to support the human performance modeling of a B757 flight crew during approach and landing. Available at: http://human-factors.arc.nasa.gov/ih/hcs/publications/757_ApproachLanding_CTA.pdf
- McGraw, J. (2005). Required navigation performance (RNP) in the United States. FAA Presentation delivered at the US/Europe International Aviation Safety Conference. Cologne, GE.
- Monterey Technologies, Inc. (2005). *Crew centered concept of operations incorporating aviation safety program technologies: 2005 update*. Contract No. NAS2-01055.
- NASA (2007). NASA NGATS / ATM-airspace project system-level design, analysis, and simulation tools. Technical Integration Report (August 27, 2007).
- Olson, W.A. & Sarter, N.B. (2001). Management-by-consent in human-machine systems: When and why it breaks down. *Human Factors*, 43(2), 255-266.
- Parasuraman, R., Molloy, R., & Singh, I. L. (1993). Performance consequences of automation-induced complacency. *International Journal of Aviation Psychology*, 3(1), 1-23.
- Pew, R.W., Miller, D.C. & Feehrer, G.G. (1981). *Evaluation of proposed control room improvements through the analysis of critical operator decisions*. EPRI Report NP 1982. Palo Alto, CA: Electric Power Research Institute.
- Prinzel, L.J. III & Jones, D.R. Cockpit technology for the prevention of general aviation runway incursions. Available at: http://ntrs.nasa.gov/archive/nasa/casi.ntrs.nasa.gov/20070018290_2007018395.pdf
- Sarter, N., & Woods, D. D. (2000). Team play with a powerful and independent agent: A full-mission simulation study. *Human Factors*, 42(3), 390-402.
- Schleicher, D., Sorensen, J., & Hunter, G. *NASA next-generation air transportation system (NextGen) system level concept design (NNSLCD) terminal domain system design* (June 30, 2007). NASA Contract No. NAS2-02076.
- Sebok, A., Wickens, C., Leiden, K., Kamienski, J., & Bagnall, T. (2006). *Cockpit-based wake vortex visualization: Final report*. Contract number: NNL06AA28P. Phase I Small Business Innovative Research Project for NASA Langley.
- Sheridan, T.B. *Next generation air transportation systems: Human-automation interaction and organizational risks* Available at: http://www.resilience-engineering.org/RE Papers/Sheridan_R.pdf

- Sweet, D., Hunter, G., & Bushman, D. (2007). *NASA next generation air transportation systems (NextGen) system level concept design (NNSLCD) en-route domain system design* (June 30, 2007). NASA Contract No. NAS2-02076.
- Swenson, H., Barhydt, R. & Landis, M. (2006). *Next generation air transportation systems (NGATS) air traffic management (ATM)-airspace project*. Available at: http://www.aeronautics.nasa.gov/nra_pdf/airspace_project_c1.pdf
- Waggoner, E.G. *Enterprise architecture and engineering division products and status*. PowerPoint presentation delivered to the JPDO All Hands Meeting. (July 27, 2007).
- Weather Integrated Product Team, Joint Planning and Development Office. (2006). *Next generation air transportation systems: Weather concept of operations*. Version 1.0. Available at: http://www.jpdo.gov/library/Weather_ConOps.pdf
- Young, S.D. & Jones, D.R. (2001). *Runway incursion prevention: A technology solution*. Presented at the Joint Meeting of the Flight Safety Foundation's 54th Annual International Air Safety Seminar, the International Federation of Airworthiness' 31st International Conference, and the International Air Transport Association. Athens, Greece.

CHAPTER 7. APPENDIX B. PHASE 1 CURRENT DAY ARRIVAL SCENARIO TASK ANALYSIS

| Event / Task Description | Operator | Type | Duration | Display / alert | Control | Other info rqmts |
|---|----------|------------|----------|-----------------|-------------------------------------|------------------|
| In Cruise Flight from HNL to SFO | | | | | | |
| <ul style="list-style-type: none"> • Flight Level 370 • ~25 NM West of CINNY intersection • Radar Contact • Strategic Lateral Offset Procedure (SLOP) removed • Altimeter setting = STD • Day, Instrument Meteorological Conditions (IMC) • Primary radio is tuned to 127.800 • Secondary radio tuned to 121.500 • Speed is MACH .84 • Aircraft is in clean configuration: Flaps up, Gear up, Exterior lights off, Seatbelt sign is off • > 150 miles out from airport • Routing in the FMC (ILS RW28L): CINNY, HADLY, OSI, MENLO, ROKME, HEMAN, OKDUE, RW28L, OLYMM • Both pilots have the appropriate section of En Route Chart displayed • Meal trays and beverage containers have been returned to the cabin • Flight Deck Door is secure | | | | | | |
| Request Gate Information | Either | Discrete | 5-10 s | | Cursor Control Device - on pedestal | |
| Request Approach ATIS through ACARS | Either | Discrete | 5-10 s | | Cursor Control Device - on pedestal | |
| COMM Message is displayed on Upper EICAS | | | | | | |
| Listen to all ATC radio transmissions | Both | Continuous | | Headset | | |

Appendix B – Arrival Task Analysis

| | | | | | | |
|---|--------|--------------|--------------------------------------|-------------|-------------------------------------|--|
| Listen to all ELTs or emergency radio transmissions | Both | Occasionally | listening, but rarely heard | Headset | | |
| Observe TCAS targets | Both | Intermittent | scan ND; 2-3 s | NAV | | |
| Scan for traffic out the window | Both | Intermittent | scan 5-20 s, depending on conditions | OTW | | |
| COMM button is pressed on the DSP | Either | Discrete | 0.5 s | Upper EICAS | | |
| Display gate information on lower EICAS | Either | Discrete | 2-3 s | | Comm button (DSP) | |
| Display gate information on lower EICAS | Either | Discrete | 2-3 s | | Cursor Control Device - on pedestal | |
| Expected Gate is B82 | | | | | | |
| Tune 131.0 as the standby number in the number 2 RTP (Ramp Control) | F/O | Discrete | 2-3 s | | Radio | |
| Display Approach information Bravo on the lower EICAS ATIS: Romeo, 19:53Z Wind: 280°/8G12 Visibility: 5NM Sky conditions: 300 Overcast Temperature: 12° Dew Point: 8° Altimeter: 29.84 Landing Runway: ILS/PRM RW 28L | PF | Discrete | CCD action 1-2 s; reading 5-10 s. | Lower EICAS | Cursor Control Device - on pedestal | |
| Enter 29.84 into the primary altimeters (but do not set) | Both | Discrete | 3-4 s per altimeter | | Knob on EFIS (set actual) | |

Appendix B – Arrival Task Analysis

| | | | | | | |
|--|------|---------------------------------|---|----------------------------|-----------------------------------|--|
| | | | | | pressure using the inner knob) | |
| Watch until altimeter setting is correct | Both | Continuous (but short duration) | see above | Bottom right corner of PFD | | |
| Stop adjusting altimeter | Both | Discrete | see above | | Release knob on EFIS | |
| Enter 29.84 into the secondary altimeter (but do not set) | CPTN | Discrete | see above | | Knob on the Standby altimeter | |
| Watch until altimeter setting is correct | CPTN | Continuous (but short duration) | see above | On the Standby altimeter | | |
| Stop adjusting altimeter | CPTM | Discrete | see above | | Release knob on Standby Altimeter | |
| Press the DEP-ARR button on MCDU to review selected approach | PF | Discrete | Button press: 1 s; Review arrival and approach: (10-15 min) for each pilot. | | CDU | |
| Enter desired ECON Descent speeds on VNAV page 3 of 3 | PF | Discrete | 3-5 s | | CDU | |
| Observe "ACT ECON DES" is title of VNAV page 3 of 3 | PF | Discrete | 0.5 s | CDU | | |
| Press the INIT-REF button | PF | Discrete | 0.5 s | | CDU | |
| Select Flaps 30 Approach Speed to enter into scratch pad | PF | Discrete | 0.5 s | | CDU - press button 3R | |
| Select as new "active" value | PF | Discrete | 0.5 s | | CDU - press button 4R | |
| Observe target speeds on PFD | Both | Discrete | 1 s | PFD | | |

Appendix B – Arrival Task Analysis

| | | | | | | |
|--|------|---------------------------------|--|--|--|---------------------------------|
| Speed Tape | | | | | | |
| Compare crossing restrictions on STAR and 28L Approach with MCDU LEGS page | Both | Discrete | Button press: 1 s; Reviewing arrival and approach: 10-15 min for each pilot. | Standard Arrival Chart (STAR), approach chart, and CDU | | Comparisons across data sources |
| Observe Landing fuel on Progress Page 1 | Both | Discrete | 1 s | CDU | | |
| Tune 125.15 as the active number in the number 2 RTP | PF | Discrete | 2-3 s | | Radio controls on pedestal | |
| Find DH for 28L | PNF | Discrete | 1 s | Approach chart | | |
| Inform PF of DH | PNF | Discrete | 2-3 s | | Verbal - spoken | |
| Set Decision Height to 213 feet - Select BARO | Both | Discrete | 1-2 s to select BARO | | Turn the outer ring on the RST knob on the left and right EFIS | |
| Check that the PFD shows BARO for DH altitude information | Both | Discrete | 2 s | PFD (lower right of center) | | |
| Set the DH altitude to 213 feet | Both | Continuous (but short duration) | 3-5 s each pilot | Monitor setting changes on PFD | Turn the inner RST knob on the left and right EFIS | |
| Check that the PFD shows 213 for DH altitude information | Both | Discrete | 1 s | PFD | | |

Appendix B – Arrival Task Analysis

| | | | | | | |
|---|------|----------|-----------|----------------------------|--------------------|---|
| Brief ILS/PRM 28L Approach PF briefs; PNF listens, nods, asks questions | PF | Discrete | 5-10 min. | | | memory to cue the PF to start the checklist |
| “ILS/PRM 28L Approach page 11-3A” | PF | Discrete | 2-3 s | | Verbal - spoken | |
| Confirms that ILS/PRM 28L Approach is on page 11-3A | PNF | Discrete | 0.5 s | Approach chart | | |
| Verbal confirmation "Check - 11- 3A" | PNF | Discrete | 1 s | | Verbal - spoken | |
| “125.15 is pre tuned as the monitor frequency on the number 2 RTP” | PF | Discrete | 3 s | | Verbal - spoken | |
| Confirms that 2 RTP is pre-tuned to 125.15 | PNF | Discrete | 1 s | Radio panel on pedestal | | |
| Verbal confirmation "Check - 125.15 on 2 RTP" | PNF | Discrete | 2 s | | Verbal - spoken | |
| “14 DEC 07” | PF | Discrete | 1 s | | Verbal - spoken | |
| Confirms that the chart date is 14 Dec 07 | PNF | Discrete | 0.5 s | Approach chart | | |
| Verbal confirmation "Check - 14 Dec 07" | PNF | Discrete | 1 s | | Verbal - spoken | |
| “LOC frequency 109.55 is displayed on PFD” | PF | Discrete | 2-3 s | | Verbal - spoken | |
| Cross check 109.55 is set on both sides for IDENT | Both | Discrete | 2-3 s | PFD | | |
| Verbal confirmation "Check - LOC frequency 109.55" | PNF | Discrete | 2-3 s | | Verbal - spoken | |

Appendix B – Arrival Task Analysis

| | | | | | | |
|--|------|----------|-------|----------------|-----------------|---|
| | | | | | | At 2500 feet, the pilot should say "altimeter set at the minimum safe altitude" This serves as the reminder for checking ILS is tuned and identified. |
| "ILS is not Identified" | PF | Discrete | 1-2 s | | Verbal - spoken | |
| Confirms that ILS is not identified | PNF | Discrete | 0.5 s | PFD | | |
| Verbal confirmation "Check - ILS not identified" | PNF | Discrete | 1-2 s | | Verbal - spoken | |
| "Final Approach Course is 281" | PF | Discrete | 2-3 s | | Verbal - spoken | |
| Confirms that the final approach course is 281 | PNF | Discrete | 0.5 s | Approach chart | | |
| Verbal confirmation "Check - final approach course is 281" | PNF | Discrete | 1-2 s | | Verbal - spoken | |
| "Cross ROKME on the glideslope at 4000' MSL" | PF | Discrete | 3 s | | | |
| Confirms that the path crosses ROKME on the glideslope at 4000' MSL | PNF | Discrete | 1-2 s | Approach chart | | |
| Verbal confirmation "Check - cross ROKME on the glideslope at 4000' MSL" | PNF | Discrete | 3 s | | Verbal - spoken | |
| "DH is 213 feet on the BARO" | PF | Discrete | 2 s | | Verbal - spoken | |
| Cross Check 213 feet is set on both sides | Both | Discrete | 1 s | PFD | | |

Appendix B – Arrival Task Analysis

| | | | | | | |
|---|-----|----------|---------|-------------------------------|-----------------|--|
| Verbal confirmation "Check 213 feet on the BARO" | PNF | Discrete | 2 s | | Verbal - spoken | |
| “At DH we need to see some part of the approach lighting system. If we do see some part of it we can descend to 100 feet below the DH. At which point we need to see the landing environment” | PF | Discrete | 10 s | | | From memory |
| Verbal confirmation "Roger" | PNF | Discrete | 0.5 s | | Verbal - spoken | |
| “Touch Down Zone Elevation is 13 Feet” | PF | Discrete | 3 s | | | |
| Confirm that the touch down zone elevation is 13 feet. | PNF | Discrete | 0.5 s | Approach chart | | |
| Verbal confirmation "Check, 13 feet." | PNF | Discrete | 1 s | | Verbal - spoken | |
| “Set 100 feet in the MCP at Glideslope capture” | PF | Discrete | 3 s | | Verbal - spoken | From memory - need to round up to 100 feet |
| Verbal confirmation "Roger" | PNF | Discrete | 0.5 s | | Verbal - spoken | |
| “Minimum Safe Altitude is 4,500 feet as we intercept final” | PF | Discrete | 3 s | | | |
| Confirm that the minimum safe altitude is 4,500 feet | PNF | Discrete | 1 s | Approach chart | | |
| Verbal confirmation "Check, 4500 feet" | PNF | Discrete | 1 s | | Verbal - spoken | |
| “In the event of a missed approach it will be Go Around Thrust, Flaps 20, Positive Climb, Gear Up, Set the missed approach altitude of 3,000 feet. Climb to 600 feet then climbing | PF | Discrete | 10-15 s | Reads from the approach chart | Verbal - spoken | From memory |

Appendix B – Arrival Task Analysis

| | | | | | | |
|---|-----|----------|-------------------|-----------------------------------|-----------------|--|
| RIGHT turn to 3000 feet via 285° heading and outbound on the SFO VOR R-280 to OLYMM and Hold that is at the SFO 15.0 DME” | | | | | | |
| Confirm that this is the missed approach plan | PNF | Discrete | 5 s (in parallel) | Approach chart | | |
| Verbal confirmation "Roger" | PNF | Discrete | 0.5 s | | Verbal - spoken | |
| “There is a PAPI on the Left” | PF | Discrete | 2 s | | | |
| Confirm that there is a PAPI on the left | PNF | Discrete | 0.5 s | Approach chart | | |
| Verbal confirmation "Check - PAPI on the left" | PNF | Discrete | 1 s | | Verbal - spoken | |
| “We need ½ Mile visibility to shoot the approach and we have 5” | PF | Discrete | 3 s | | Verbal - spoken | |
| Confirm that 1/2 mile visibility is needed. | PNF | Discrete | 0.5 s | Approach chart | | |
| Confirm that current visibility is 5 miles | PNF | Discrete | 0.5 s | ATIS on lower EICAS | | |
| Verbal confirmation "Check - 1/2 mile visibility needed." | PNF | Discrete | 2 s | | Verbal - spoken | |
| “The Runway is 10,602 feet long” | PF | Discrete | 2 s | Approach chart or airport diagram | Verbal - spoken | |
| Confirm that the runway is 10,602 feet long. | PNF | Discrete | 2 s | Approach chart or airport diagram | | |
| Verbal confirmation "Check - the | PNF | Discrete | 2 s | | Verbal - | |

Appendix B – Arrival Task Analysis

| | | | | | | |
|--|-----|----------|--------------|-----------------------------------|-------------------------------|-------------------------------|
| runway is 10,602 feet long." | | | | | spoken | |
| “This will be a Flaps 30 landing with Auto-throttles and AUTO Brakes 2” | PF | Discrete | 2-3 s | | Verbal - spoken | memory |
| Verbal confirmation "Roger - flaps 30, auto-throttles, and AUTO brakes 2" | PNF | Discrete | 2-3 s | | Verbal - spoken | memory |
| “Let’s Plan on a left turn off at Tango” | PF | Discrete | 1-2 s | Approach chart or airport diagram | Verbal - spoken | memory |
| Confirm the location of taxiway Tango | PNF | Discrete | 1 s | airport diagram | | |
| Verbally confirm "Roger - left at Tango" | PNF | Discrete | 1 s | | Verbal - spoken | |
| Please review the requirements on Page 11-3 and let me know when you have reviewed them. | PF | Discrete | 3 s to speak | | Verbal - spoken | |
| Read the requirements on page 11-3. | PNF | Discrete | 3-5 minutes | Approach chart | | Reading a solid page of text. |
| Verbal confirmation "The requirements on Page 11-3 have been reviewed" | PNF | Discrete | 3 s to speak | | Verbal - spoken | |
| Pull up the Terrain view on the NAV display | PF | Discrete | 1 s | | TERR button on the MCP / EFIS | |
| Ensure the Terrain view is presented | PF | Discrete | 0.5 s | NAV display | | |
| Verbal confirmation - "I have terrain up on my side" | PF | Discrete | 1 s | | Verbal - spoken | |
| Select RADAR on your side | PF | Discrete | 2 s to speak | | Verbal - spoken | |

Appendix B – Arrival Task Analysis

| | | | | | | |
|---|-----|----------|---|-------------|--|--|
| Pull up the Weather view on the NAV display | PNF | Discrete | 1 s | | WXR button on MCP / EFIS | |
| Ensure the Weather view is presented | PNF | Discrete | 0.5 s | NAV display | | |
| Select Tilt | PNF | Discrete | 5-10 s for this step plus next 2 steps. | | Tilt toggle on the left side of the pedestal | |
| Rotate to adjust tilt | PNF | Discrete | see above | | Tilt adjustment knob on the pedestal | |
| Ensure Weather view is appropriate | PNF | Discrete | see above | NAV display | | |
| Verbal confirmation - "I have weather here" | PNF | Discrete | 1 s | | Verbal - spoken | |
| "Do you have any Questions?" | PF | Discrete | 1 s | | Verbal - spoken | |
| "No Questions" | PNF | Discrete | 0.5 s | | Verbal - spoken | |
| "Approach Descent Check List" | PF | Discrete | 1 s | | Verbal - spoken | PF knows to begin this from memory / experience / training |
| Open the "Approach Descent Checklist" | PNF | Discrete | 1 s | | CHKL button on the Display Select Panel | |
| View the Approach Descent Checklist | PNF | Discrete | 0.5 s | Lower EICAS | | |
| "Operational notes have been | PNF | Discrete | 2 s | Lower | | reading |

Appendix B – Arrival Task Analysis

| | | | | | | |
|---|-----|----------|---|-------------|------------------------------------|--|
| reviewed” | | | | EICAS | | |
| Verbal confirmation - "Check" | PNF | Discrete | 0.5 s | | Verbal - spoken | memory |
| “Approach Briefing is complete” | PNF | Discrete | 1 s | Lower EICAS | | reading |
| Verbal confirmation - "Check" | PNF | Discrete | 0.5 s | | Verbal - spoken | memory |
| “FMC’s and radios are set for approach (PFD, MCDU)” | PNF | Discrete | 2-3 s | Lower EICAS | | reading |
| Confirm that the Flight Management Computers are set for approach | PNF | Discrete | 3-5 s | PFD and CDU | | Comparison of waypoints listed on the CDU (legs page) and the Approach chart |
| Verbal confirmation - "Check" | PNF | Discrete | 0.5 s | | Verbal - spoken | |
| “EGPWS You are in Terrain I’m on RADAR” | PNF | Discrete | 2-3 s | Lower EICAS | | reading |
| Check that the PF has Terrain | PNF | Discrete | 1 s | PF's NAV | | |
| Verify that the PNF has RADAR | PNF | Discrete | 1 s | PNF's NAV | | |
| Verbal confirmation - "Check" | PNF | Discrete | 0.5 s | | Verbal - spoken | |
| Recall (bring up) the EICAS "alerts list" | PNF | Discrete | 1 s | | Hit the CANC/RCL button on the DSP | |
| View the EICAS "alarm list" on EICAS | PNF | Discrete | 1-2 s, but could be longer if problems arose during flight. | | | |
| Confirm that all issues have been addressed | PNF | Discrete | variable; based on above | EICAS | | reading / memory |

Appendix B – Arrival Task Analysis

| | | | | | | |
|--|-----|----------|-------|-------------|--|----------------------------------|
| EICAS - "alerts list" cancel | PNF | Discrete | 1 s | | Hit the CANC/RCL button on the DSP | |
| “FMC REF Speed 30 FLAPS 143 set (INIT REF Page)” | PNF | Discrete | 3-5 s | Lower EICAS | | reading |
| Verify that the Flaps 30 speed is set to 143 | PNF | Discrete | 1 s | PFD | | |
| Verbal confirmation - "Check" | PNF | Discrete | 0.5 s | | Verbal - spoken | |
| “AUTO Brakes Level 2 Set” | PNF | Discrete | 1 s | Lower EICAS | | reading |
| Set AUTO Brakes to Level 2 | PNF | Discrete | 1 s | | Turn AUTO brakes on the forward instrument panel (Landing gear controls) | |
| Verbal confirmation - "Check" | PNF | Discrete | 0.5 s | | Verbal - spoken | |
| “Altimeters to go” (altimeters not yet completed on the checklist) | PNF | Discrete | 1 s | Lower EICAS | | reading and making a mental note |
| Return the engine display to the upper EICAS | PNF | Discrete | 1 s | | press the ENG (engine) button on the DSP | |
| Verify that the engine display is shown | PNF | Discrete | 0.5 s | Upper EICAS | | |

Appendix B – Arrival Task Analysis

| | | | | | | |
|--|-----|----------|-------------------------------------|--------------------------|--|--|
| ATC communication: “United 573 Oakland Center; Descend at Pilot’s discretion to FL230” | ATC | Discrete | 3 s | Headset - verbal message | | |
| Radio to ATC | PNF | Discrete | press and hold button while talking | | Radio button (far left / <u>right</u> of glare shield) | |
| Read back clearance | PNF | Discrete | 3 s | | Verbal - spoken | |
| Set FL230 into the MCP Altitude window | PNF | Discrete | 3 s | | Dial 230 using the MCP altitude knob and checking the MCP altitude indicator | |
| Check altitude set to FL 230 (23000 on the display) | PF | Discrete | 0.5 s | MCP altitude display | | |
| Point to altitude | PF | Discrete | 1 s | | Point with index finger to the MCP altitude setting | |
| Verbally confirm (state) the altitude setting | PF | Discrete | 1 s | | Verbal - spoken | |
| PA announcement | PNF | Discrete | 2 s to initiate | | Pick up the phone from the pedestal | |
| Brief weather to passengers and when Seat belt sign will be turned on | PNF | Discrete | 20-30 s to speak | | Verbal - spoken | |
| At top of descent | | | | | | |

Appendix B – Arrival Task Analysis

| ~110 miles out from airport | | | | | | |
|--|------|----------|---------------------------------------|---------------------------------------|--|---|
| Observe Throttles retard to idle | Both | Discrete | 1 s | Throttles (on the pedestal) move back | | |
| Radio to ATC | PNF | Discrete | push and hold button during next step | | Radio button (far left / <u>right</u> of glare shield) | |
| State “United 573 is leaving FL370 for FL230” | PNF | Discrete | 3 s | | Verbal - spoken | |
| ATC responds “United 573 going to FL230” | ATC | Discrete | 3 s | Headset | | |
| Observe engine indications on EICAS | Both | Discrete | 1 s | Upper EICAS | | Steps 150-154 happen nearly simultaneously. |
| Feel Pitch change | Both | Discrete | 1 s | Kinesthetic | | |
| Note FMA changes (VNAV ALT to VNAV PATH) | Both | Discrete | 1 s | Top line on the PFD | | |
| Observe VSI move and then stabilize on PFD | Both | Discrete | 1 s | Bar along the right of the PFD | | |
| Observe Altitude decreasing on PFD | Both | Discrete | 1 s | Bar along the right of the PFD | | |
| ~Passing FL250 | | | | | | |
| ~75 miles out from airport | | | | | | |
| ATC communication: “United 573 contact NORCAL Approach on 134.5” | ATC | Discrete | 3 s | Headset | | |
| Radio to ATC | PNF | Discrete | simultaneous with next step | | Radio button (far left / <u>right</u> of glare | |

Appendix B – Arrival Task Analysis

| | | | | | | |
|---|-----|----------|-----------------------------|---------|--|--|
| | | | | | shield) | |
| Read back clearance | PNF | Discrete | 2 s | | Verbal - spoken | |
| Tune 134.5 as the standby number into the number 1 RTP | PNF | Discrete | 3 s | | Radio controls on pedestal | |
| Select 134.5 into “Active windows” or RTP | PNF | Discrete | 0.5 s | | Radio controls on pedestal | |
| Radio to ATC | PNF | Discrete | simultaneous with next step | | Radio button (far left / <u>right</u> of glare shield) | |
| “United 573 is with you passing 24.2 for FL230, with information Bravo” | PNF | Discrete | 4 s | | Verbal - spoken | |
| ATC responds “United 573; NORCAL Approach continue your descent to 12 thousand; Expect ILS RW 28L; San Francisco altimeter 29.84” | ATC | Discrete | 5 s | Headset | | |
| “Expect ILS” means that the Precision Radar Monitoring is not in use | | | | | | |
| Radio to ATC | PNF | Discrete | simultaneous with next step | | Radio button (far left / <u>right</u> of glare shield) | |
| Read back clearance and add “United 573 is continuing to 12 thousand on 29.84” | PNF | Discrete | 3 s | | Verbal - spoken | |

Appendix B – Arrival Task Analysis

| | | | | | | |
|---|------|----------|------------------------------------|----------------------|---|--|
| Set 12,000 into the MCP Altitude window | PNF | Discrete | 2 s | | Dial 12000 using the MCP altitude knob and checking with the MCP altitude indicator | |
| Check altitude set to 12,000 feet | PF | Discrete | 0.5 s | MCP altitude display | | |
| Point to altitude | PF | Discrete | 2 s | | Point with index finger to the MCP altitude setting | |
| Verbally confirm (state) the altitude setting | PF | Discrete | 1 s (simultaneous with above step) | | Verbal - spoken | |
| Press knob to activate the selection | PF | Discrete | 1/2 second | | ALT button (not labeled) on the MCP | |
| Passing FL180 | | | | | | |
| ~56 miles out from airport | | | | | | |
| Set Primary altimeter to 29.84 | Both | Discrete | 1 s | | press the RST knob / button on EFIS | |
| Observe change on PFD and cross check | Both | Discrete | 2 s | PFD | | |
| Set Secondary altimeter to 29.84 | CAP | Discrete | 1 s | | press the knob / button | |

Appendix B – Arrival Task Analysis

| | | | | | | |
|--|------|--------------|----------------------------------|-------------|----------------------------------|--|
| | | | | | on the Standby Altimeter | |
| Turn on exterior lights | CAP | Discrete | 2 s | | Light switches on overhead panel | |
| Re-open the Approach Descent checklist | PNF | Discrete | 1 s | | Press the CHKL button on the DSP | |
| Check Altimeters as complete on the checklist | PNF | Discrete | 3 s | | CCD (point and click) | |
| Observe all items on ECL are green | PNF | Discrete | done in parallel with above step | Upper EICAS | | |
| Verbally confirm “Altimeters are set to 29.48 Approach Descent Checklist is complete | PNF | Discrete | 4 s | | Verbal - spoken | |
| Confirm "Roger" | PF | Discrete | | | Verbal - spoken | |
| <ul style="list-style-type: none"> • 15,000ft MSL • ~45 miles out from airport | | | | | | |
| Listen to all ATC radio transmissions | Both | Continuous | | Headset | | |
| Listen to all ELT’s or emergency radio transmissions | Both | Occasionally | | Headset | | |
| Observe TCAS targets | Both | Intermittent | 2 s to scan ND | NAV | | |
| Scan for traffic out the window | Both | Intermittent | 10 s | OTW | | |

Appendix B – Arrival Task Analysis

| | | | | | |
|--|------|----------|-----------------------------|--------------------------|---|
| ATC communication: “United 573 Continue descent to 10,000 feet and contact NORCAL Approach on ~126.95” | ATC | Discrete | 3 s | Headset – verbal message | |
| Radio back to ATC | PNF | Discrete | simultaneous with next step | | Push radio button (at far left / <u>right</u> glare shield) |
| Read back clearance | PNF | Discrete | 3 s | | Verbal - spoken |
| Tune 127.45 as the standby number into the number 1 RTP | PNF | Discrete | 3 s | | Radio controls on pedestal |
| Select 127.45 into “Active windows” or RTP | PNF | Discrete | 1 s | | Radio controls on pedestal |
| “United 573 is with you passing 14.4 for 10 thousand.” | PNF | Discrete | 3 s | | Verbal - spoken |
| ATC communication: “Roger United 573 San Francisco altimeter 29.85” | PNF | Discrete | 3 s | Headset – verbal message | |
| Radio back to ATC | PNF | Discrete | simultaneous with next step | | Push radio button (at far left / <u>right</u> glare shield) |
| Read back "Altimeter now 29.85.” | PNF | Discrete | 2 s | | Verbal - spoken |
| Set primary altimeters to 29.85 | Both | Discrete | 1 s (each pilot) | | Knob on EFIS (select IN or HPA using the outer ring, |

Appendix B – Arrival Task Analysis

| | | | | | | |
|---|------|---------------------------------|-------------------------------|----------------------------|--|-------------------|
| | | | | | and set the actual pressure with the inner knob) | |
| Watch until altimeter setting is correct | Both | Continuous (but short duration) | simultaneous with above step | Bottom right corner of PFD | | |
| Stop adjusting altimeter | Both | Discrete | simultaneous with above steps | | Release knob on EFIS | |
| Set secondary altimeter to 29.85 | CPTN | Discrete | 2 s | | Knob on the Standby Altimeter (select IN or HPA using the outer ring, and set the actual pressure with the inner knob) | |
| Watch until altimeter setting is correct | PF | Continuous (but short duration) | simultaneous with above step | On the Standby Altimeter | | |
| Stop adjusting altimeter | PF | Discrete | simultaneous with above steps | | Release knob on Standby Altimeter | |
| Cross check altimeter settings | Both | Discrete | 1 s | Look at the PFD | | |
| State altimeter setting | Both | Discrete | simultaneous with above step | | Verbal – spoken | |
| Confirm that they have the same information | Both | Discrete | 1 s | | | Mental comparison |

Appendix B – Arrival Task Analysis

| | | | | | | |
|---|------|----------|------------------------------|------------------------------|--|--|
| Observe altitude passing 11,000 feet | Both | Discrete | 0.5 s | PFD | | |
| Altitude call out: “Passing 11 thousand for 10 thousand” | PNF | Discrete | 3 s | | Verbal - spoken | |
| Verify passing altitude | PF | Discrete | 0.5 s | PFD | | |
| Confirm passing altitude | PF | Discrete | 1 s | | Verbal - spoken | |
| Observe VSI reducing to zero as aircraft approaches 10,000’ | PF | Discrete | 2-second glance | PFD (strip along right side) | | |
| Observe FMA change from VNAV PTH to [ALT] then ALT | Both | Discrete | 0.5 s | PFD (strip along top) | | |
| | | | | | Push IAS button / knob on MCP | |
| | | | | | Turn inner knob until 250 is displayed in the IAS window | |
| Select a speed of 250 | PF | Discrete | 3 s | | | |
| Confirm speed set to 250 | PF | Discrete | 0.5 s | PFD (white indication) | | |
| Set speed to 250 | PF | Discrete | simultaneous with above step | | Push IAS button to set speed | |

Appendix B – Arrival Task Analysis

| | | | | | | |
|-----------------------------------|------|----------|--|--|--|--|
| Observe throttles remain retarded | Both | Discrete | 0.5 s | Visual / kinesthetic observation that the throttles move forward (1) | 1) While the throttles are actually a control, they are listed as a display here because that is how they are used for this particular step. The PF and PNF observe that the throttles do not move. | |
| Feel pitch change | Both | Discrete | simultaneous with above step and next step | Kinesthetic | | |
| Observe speed change to 250 | Both | Discrete | glances over several seconds | PFD | | |
| Observe throttles increasing | Both | Discrete | As speed reaches 250, watch or feel throttles for a second or 2. | Visual / kinesthetic observation that throttles move forward | | |
| Hear additional thrust | Both | Discrete | simultaneous with above | Auditory cue | | |
| Feel pitch stabilize | Both | Discrete | simultaneous with above | Kinesthetic | | |
| Observe speed stabilize | Both | Discrete | simultaneous with above | PFD | | |

Appendix B – Arrival Task Analysis

| | | | | | | |
|---|------|----------|-----------------------------|---|---|--|
| Observe throttles stabilize | Both | Discrete | simultaneous with above | Visual / kinesthetic observation that throttles stop moving | | |
| In level flight at 10,000 feet MSL | | | | | | |
| • ~32 miles out from airport | | | | | | |
| ATC communication: “United 573 Contact NORCAL Approach on 126.95” | ATC | Discrete | 3 s | Headset | | |
| Radio back to ATC | PNF | Discrete | simultaneous with next step | | Push radio button (at far left / <u>right</u> glare shield) | |
| Read back clearance: "UAL 573 switching; good day." | PNF | Discrete | 1 s | | Verbal – spoken | |
| Tune 126.95 into RTP | PNF | Discrete | 3 s | | Radio controls – pedestal | |
| Select 126.95 into “Active windows” or RTP | PNF | Discrete | 0.5 s | | Radio controls – pedestal | |
| ATC communication: “United 573 is with you at 10 thousand ” | PNF | Discrete | 3 s | | Verbal – spoken | |
| ATC communication: “Roger United 573 San Francisco altimeter 29.85” | PNF | Discrete | 3 s | Headset | | |
| Radio back to ATC | PNF | Discrete | simultaneous with next step | | Push radio button (at far left / <u>right</u> glare shield) | |

Appendix B – Arrival Task Analysis

| | | | | | | |
|--|------|----------|-----------------------------|------------------------|---|--------------------------------|
| Read back clearance “29.85” | PNF | Discrete | 2 s | | Verbal – spoken | |
| Verify that primary altimeters are set to 29.85 | Both | Discrete | 1 s glance | PFD – lower right side | | |
| Verify that the secondary altimeter is set to 29.85 | CPTN | Discrete | 1 s glance | Standby altimeter | | |
| Cross check altimeter settings | Both | Discrete | 1 s cross-check | | | Verbalize and mentally compare |
| ATC communication: “United 573 NORCAL approach. Descend and maintain 7,000 feet, then reduce speed to 210 knots” | ATC | Discrete | 4 s | Headset | | |
| Radio back to ATC | PNF | Discrete | simultaneous with next step | | Push radio button (at far left / <u>right</u> glare shield) | |
| Read back clearance: “United 573 is leaving 10,000 for 7 thousand then slowing to 210 knots” | PNF | Discrete | 4 s | | Verbal - spoken | |
| Descending from 10,000 ft level flight to 7,000 feet MSL | | | | | | |
| Set MCP altitude to 7,000 | PNF | Discrete | 2 s | | Dial 7000 using the MCP altitude knob and checking the MCP Altitude | |

Appendix B – Arrival Task Analysis

| | | | | | | |
|---|------|----------|--|--|---|--|
| | | | | | indicator. | |
| Check altitude set to 7,000 | PF | Discrete | 0.5 s | MCP – altitude display | | |
| Point to altitude | PF | Discrete | 1 s | | Point with index finger to the MCP altitude setting | |
| Verbally confirm (state) the altitude setting | PF | Discrete | simultaneous with above step | | Verbal – spoken | |
| Press FLCH | PF | Discrete | 1 s | | Button on the MCP | |
| Observe FMA change from ALT to [FLCH] then FLCH | Both | Discrete | 0.5 s | Top line of the PFD | | |
| Observe throttles retard to idle | Both | Discrete | This step and next 6 steps together over a few seconds | Visual / kinesthetic observation of throttles moving | | |
| Hear a reduction in thrust | Both | Discrete | see above | Auditory feedback | | |
| Feel pitch change | Both | Discrete | see above | Kinesthetic feedback | | |
| Observe pitch on PFD | Both | Discrete | see above | PFD (center) | | |
| Observe altitude changing on altimeter | Both | Discrete | see above | PFD (strip along the right side) | | |

Appendix B – Arrival Task Analysis

| | | | | | | |
|--|------|----------|----------------------------|--|-----------------------------|--|
| Observe VSI stabilizing | Both | Discrete | see above | PFD (strip along the right side) | | |
| Ensure speed is stable at 250 | PF | Discrete | see above | PFD (strip along the left side) | | |
| Passing 8,000 feet MSL | | | | | | |
| • ~27 miles out from airport | | | | | | |
| Observe altitude passing 8,000 feet | Both | Discrete | 0.5 s | PFD (strip along the right side) | | |
| Altitude call out: “Passing 8 thousand for 7 thousand” | PNF | Discrete | 2 s | | Verbal - spoken | |
| Verify passing altitude | PF | Discrete | 0.5 s | PFD (strip along the right side) | | |
| Confirm passing altitude | PF | Discrete | 1 s | | Verbal - spoken | |
| PA Announcement | PNF | Discrete | 2 s | | Pick up phone from pedestal | |
| PA Announcement: “Flight attendants prepare for landing” | PNF | Discrete | 2 s | | Verbal - spoken | |
| Observe VSI reducing to zero | PF | Discrete | glances over a few seconds | PFD (strip along the right side (to the right of airspeed tape)) | | |
| Observe FMA change from FLCH to [ALT] then ALT | Both | Discrete | see above | PFD (strip along the top) | | |
| Hold throttles so they remain | Both | Discrete | 0.5 s | | throttles - | |

Appendix B – Arrival Task Analysis

| | | | | | | |
|----------------------------------|------|----------|---------------------------------|---|--|--|
| retarded | | | | | hold in position | |
| | | | | | Push IAS button / knob on MCP | |
| | | | | | Turn inner knob until 210 is displayed in the IAS window | |
| Select a speed to 210 | PF | Discrete | 2 s | | | |
| Confirm speed set to 210 | PF | Discrete | 0.5 s | PFD (white indication) | | |
| Set speed to 210 | PF | Discrete | 0.5 s | | Push IAS button to set speed | |
| Let go of throttles | PF | Discrete | 0.5 s | | throttles | |
| Observe throttles remain at idle | PF | Discrete | 0.5 s | throttles | | |
| Feel pitch change | Both | Discrete | 3 s | Kinesthetic | | |
| Observe speed change to 210 | Both | Discrete | 3 s | PFD (strip along the left side) | | |
| Observe throttles increasing | Both | Discrete | When speed reaches 210 (~ 20 s) | Visual / kinesthetic observation of throttle position | | |
| Hear additional thrust | Both | Discrete | 3 s | Auditory | | |
| Feel pitch stabilize | Both | Discrete | simultaneous with above step | Kinesthetic | | |
| Observe speed stabilize | Both | Discrete | simultaneous with above step | PFD (strip along the | | |

Appendix B – Arrival Task Analysis

| | | | | | | |
|---|------|----------|------------------------------|---|---|--|
| | | | | left side) | | |
| Observe throttles stabilize | Both | Discrete | simultaneous with above step | Visual / kinesthetic observation of throttle position | | |
| In level flight at 7,000 feet MSL | | | | | | |
| <ul style="list-style-type: none"> • ~25 miles out from airport • Flaps up • Speed 210 Knots | | | | | | |
| ATC communication: “United 573 NORCAL approach, proceed direct Woodside” (OSI VOR) | ATC | Discrete | 3 s | Headset | | |
| Radio back to ATC | PNF | Discrete | simultaneous with next step | | Push radio button (at far left / <u>right</u> glare shield) | |
| “United 573 is proceeding direct Woodside” | PNF | Discrete | 2 s | | Verbal – spoken | |
| Press legs button on CDU | PF | Discrete | 0.5 s | | CDU on the lower Forward Instrument Panel | |
| Line select OSI into the CDU scratch pad | PF | Discrete | 2 s | | CDU on the lower Forward Instrument Panel | |
| Line select OSI to 1L by pressing the button at 1L | PF | Discrete | 2 s | | CDU on the lower Forward | |

Appendix B – Arrival Task Analysis

| | | | | | | |
|--|-----------|----------|--|--|---|------------------|
| | | | | | Instrument Panel | |
| Observe OSI on legs page | Both | Discrete | 2 s | CDU on the lower Forward Instrument Panel | | |
| Confirm selection | Both | Discrete | 2 s | NAV | Verbally confirm | Compare settings |
| Execute direct OSI by pressing EXEC key on CDU | PF or PNF | Discrete | 1 s | | CDU on the lower Forward Instrument Panel | |
| Observe OSI is the active point on CDU | Both | Discrete | 1 s | CDU on the lower Forward Instrument Panel | | |
| Observe OSI is the active point on ND | Both | Discrete | 1 s | NAV display | | |
| Confirm FMA remains in LNAV | Both | Discrete | 1 s | PFD (strip along the top) | | |
| Feel aircraft bank in appropriate direction | Both | Discrete | This and next 9 steps take 20-30 s, depending on amount of turn. | Kinesthetic | | |
| Feel pitch adjustment | Both | Discrete | see above | Kinesthetic | | |
| Feel throttles increase | Both | Discrete | see above | Visual / kinesthetic observation of throttle | | |

Appendix B – Arrival Task Analysis

| | | | | | | |
|--|------|--------------|-----------------------------|---|---|--|
| | | | | position | | |
| Hear an increase in thrust | Both | Discrete | see above | Auditory | | |
| Observe aircraft roll out on new Track | Both | Discrete | see above | NAV and PFD | | |
| Feel aircraft bank in appropriate direction | Both | Discrete | see above | Kinesthetic | | |
| Feel pitch adjustment | Both | Discrete | see above | Kinesthetic | | |
| Feel throttles decrease | Both | Discrete | see above | Visual / kinesthetic observation of throttle position | | |
| Hear an reduction in thrust | Both | Discrete | see above | Auditory | | |
| Observe aircraft proceed to OSI | Both | Intermittent | see above | NAV | | |
| Vector for Approach | | | | | | |
| In level flight at 7,000 feet MSL • ~23 miles out from airport | | | | | | |
| ATC communication: “United 573 fly present heading” | ATC | Discrete | 2 s | Headset | | |
| Radio back to ATC | PNF | Discrete | simultaneous with next step | | Push radio button (at far left / <u>right</u> glare shield) | |
| Read back clearance “United 573; present heading 077” | PNF | Discrete | 2 s | | Verbal – spoken | |
| Press heading select on MCP | PF | Discrete | 1 s | | MCP (Heading select button) | |
| Observe FMA change from LNAV to [HDG] then HDG | Both | Discrete | 1 s | PFD (strip along the | | |

Appendix B – Arrival Task Analysis

| | | | | | | |
|---|-----|----------|-----------------------------|---------|---|--|
| | | | | top) | | |
| Spin heading select to present heading | PF | Discrete | 1 s | | MCP (Heading select button) | |
| ATC communication: “United 573, descend to 4,000 feet and contact NORCAL approach on 134.5” | ATC | Discrete | 4 s | Headset | | |
| Radio back to ATC | PNF | Discrete | simultaneous with next step | | Push radio button (at far left / <u>right</u> glare shield) | |
| “United 573 is leaving 7,000 for 4,000 and switching to 134.5” | PNF | Discrete | 4 s | | Verbal - spoken | |
| Tune 134.5 into RTP | PNF | Discrete | 2 s | | Radio controls on pedestal | |
| Select 134.5 into “Active windows” or RTP | PNF | Discrete | 1 s | | Radio controls on pedestal | |
| Set MCP altitude to 4,000 | PF | Discrete | 2 s | | Turn the altitude knob on the MCP until 4000 is displayed in the altitude indicator window on the MCP | |
| Visually check altitude set to 4,000 | PF | Discrete | 0.5 s | MCP | | |

Appendix B – Arrival Task Analysis

| | | | | | | |
|--|------|----------|--|---|---|--|
| Point to altitude setting and state 4000 | PF | Discrete | 1 s | | Point and verbally state | |
| Press FLCH | PF | Discrete | 1 s | | MCP | |
| Observe FMA change from ALT to [FLCH] then FLCH | Both | Discrete | 1 s | PFD (strip along the top) | | |
| Observe throttles retard to idle | Both | Discrete | this and next 5 steps take about 5 s and are simultaneous or very close in sequence. | Visual / kinesthetic observation of throttle position | | |
| Hear a reduction in thrust | Both | Discrete | see above | Auditory | | |
| Feel pitch change | Both | Discrete | see above | Kinesthetic | | |
| Observe pitch on PFD | Both | Discrete | see above | PFD (center) | | |
| Observe altitude changing on altimeter | Both | Discrete | see above | PFD (strip along the right) | | |
| Observe VSI stabilizing in descent | Both | Discrete | see above | PFD (strip along the right) | | |
| Radio to ATC | PNF | Discrete | simultaneous with next step | | Push radio button (at far left / <u>right</u> glare shield) | |
| “NORCAL, this is United 573. We are passing 6.3 for 4 thousand with information Bravo” | PNF | Discrete | 6 s | | Verbal | |
| ATC communication: “United 573, NORCAL roger” | ATC | Discrete | 2 s | Headset | | |

Appendix B – Arrival Task Analysis

| | | | | | | |
|--|------|----------|--|---|-----------------|--|
| Observe altitude passing 5,000 feet | Both | Discrete | 0.5 s | PFD (strip along the right side) | | |
| Altitude call out: “Passing 5 thousand for 4 thousand” | PNF | Discrete | 2 s | | Verbal – spoken | |
| Verify passing altitude | PF | Discrete | 0.5 s | PFD (strip along the right side) | | |
| Confirm passing altitude | PF | Discrete | 1 s | | Verbal - spoken | |
| Observe VSI reducing to zero | PF | Discrete | upon reaching 4000, this and next 6 steps are simultaneous | PFD (strip along the right side) | | |
| Observe FMA change from FLCH to [ALT] then ALT | Both | Discrete | see above | PFD (strip along the top) | | |
| Observe throttles increasing | Both | Discrete | see above | Visual / kinesthetic observation of throttle position | | |
| Hear additional thrust | Both | Discrete | see above | Auditory | | |
| Feel pitch stabilize | Both | Discrete | see above | Kinesthetic | | |
| Observe speed stabilize | Both | Discrete | see above | PFD (strip along the left side) | | |
| Observe throttles stabilize | Both | Discrete | see above | Visual / kinesthetic observation of throttle position | | |
| In level flight at 4,000 feet MSL | | | | | | |

Appendix B – Arrival Task Analysis

| • ~15 miles out from airport, 4000’ MSL, 210 Knots Indicated Air Speed • On NORCAL Approach Frequency | | | | | | |
|--|------|----------|--|--------------------------------|---|--|
| ATC communication: (Broadcasting to all aircraft on frequency) “San Francisco altimeter 29.84” | PNF | Discrete | 2 s | Headset | | |
| Radio to ATC | PNF | Discrete | simultaneous with next step, if applicable | | Push radio button (at far left / <u>right</u> glare shield) | |
| Read back clearance and altimeter pressure setting “United 573, 29.84” | PNF | Discrete | 2 s, if applicable | | Verbal – spoken | If general ATC broadcast, probably no reply from UAL 573 here. |
| Set primary altimeters to 29.84 | Both | Discrete | 2 s total | | Knob on EFIS (set the actual pressure with the inner knob) | Select IN for SFO and all US airports |
| Watch until the altimeter pressure setting is correct | Both | Discrete | simultaneous with above step | Bottom right corner of the PFD | | |
| Stop adjusting the altimeter | Both | Discrete | simultaneous with above step | | Release the knob on EFIS | |

Appendix B – Arrival Task Analysis

| | | | | | | |
|---|--------------|---------------------------------|------------------------------|---------------------------|---|-------------------|
| Set secondary altimeter to 29.84 | PF (CPTN) | Discrete | 1 s | | Knob on the Standby Altimeter (select <u>IN</u> or HPA using the outer ring, and set the actual pressure with the inner knob) | |
| Watch until altimeter setting is correct | PF | Continuous (but short duration) | simultaneous with above step | On the Standby Altimeter | | |
| Stop adjusting the altimeter | PF | Discrete | simultaneous with above step | | Release knob on Standby Altimeter | |
| Cross check altimeter settings | Both | Discrete | 2 s | Look at the PFD | | |
| State altimeter settings | Both | Discrete | simultaneous with above step | | Verbal – spoken | |
| Confirm that they have the same information | Both | Discrete | simultaneous with above step | | | Mental comparison |
| Press FLCH to adjust altitude | PF | Discrete | 1 s | | MCP | |
| Observe FMA change form ALT to [FLCH] to [ALT] to ALT | Both | Discrete | 0.5 s | PFD (strip along the top) | | |
| ATC communication: “United 573 reduce speed to 170 knots” | PNF | Discrete | 3 s | Headset | | |
| Radio to ATC | PNF | Discrete | simultaneous with next step | | Push radio button (at far left / <u>right</u> glare shield) | |

Appendix B – Arrival Task Analysis

| | | | | | | |
|--|------|----------|------------------------------|---|--|--|
| Read back clearance “United 573 is slowing to 170 Knots” | PNF | Discrete | 2 s | | Verbal - spoken | |
| Command Flaps 1 by saying “Flaps 1” | PF | Discrete | 1 s | | Verbal - spoken | |
| Select Flap handle to position 1 | PNF | Discrete | 2 s | | Flaps lever on pedestal | |
| Hear Flap Handle move to position 1 | Both | Discrete | simultaneous with 370 | Auditory | | |
| Observe Flaps 1 on EICAS | Both | Discrete | 0.5 s | EICAS (bar indicator) | | |
| Verify Flaps 1 | PF | Discrete | 1 s | View the position of the flaps lever (pedestal) | | |
| Confirm Flaps 1 | PF | Discrete | simultaneous with above step | | Verbal - spoken | |
| Select 170 knots in MCP speed window | PF | Discrete | 2 s | | Push IAS button / knob on the MCP | |
| | | | | | Turn the inner knob until 170 is displayed in the IAS window | |
| Confirm speed set to 170 | Both | Discrete | 0.5 s | PFD (white indication) | | |
| Set speed to 170 | PF | Discrete | 0.5 s | | Push IAS button to set speed | |

Appendix B – Arrival Task Analysis

| | | | | | | |
|--|------|------------------------------------|------------------------------------|---|-------------------------|--|
| Observe throttles retard (they would have been up to hold 210 in level flight) | Both | Discrete | 2 s | Visual / kinesthetic observation of throttle position | | |
| Feel pitch change | Both | Discrete | simultaneous with above step | Kinesthetic | | |
| Command Flaps 5 by saying “Flaps 5” | PF | Discrete | 1 s | | Verbal - spoken | |
| Select Flap handle to position 5 | PNF | Discrete | 2 s | | Flaps lever on pedestal | |
| Hear Flap Handle move beyond the reverse gate to position 5 | Both | Discrete | simultaneous with 384 | Auditory | | |
| Observe throttles remain retarded | Both | continuous during slow-down to 170 | slowing takes about a minute | Visual / kinesthetic observation of throttle position | | |
| Feel pitch change further as speed slows | Both | continuous during slow-down to 170 | slowing takes about a minute | Kinesthetic | | |
| Observe flaps 5 on EICAS | Both | Discrete | 1 s | EICAS (bar indicator) | | |
| Verify Flaps 5 | PF | Discrete | 1 s | View the position of the flaps lever (pedestal) | | |
| Confirm Flaps 5 | PF | Discrete | simultaneous with above step | | Verbal - spoken | |
| Command Flaps 15 by saying “Flaps 15” | PF | Discrete | {same series as for flaps 1 and 5} | | Verbal – spoken | |

Appendix B – Arrival Task Analysis

| | | | | | | |
|---|------|----------|------------------------------------|---|-------------------------|--|
| Select Flap handle to position 15 | PNF | Discrete | {same series as for flaps 1 and 5} | | Flaps lever on pedestal | |
| Feel Gate on Flap handle track | PNF | Discrete | {same series as for flaps 1 and 5} | Kinesthetic | | |
| Hear Flap Handle move to position 15 | Both | Discrete | {same series as for flaps 1 and 5} | Auditory | | |
| Announce “Flaps 15” when flaps reach 15 | PNF | Discrete | {same series as for flaps 1 and 5} | | Verbal – spoken | |
| Observe throttles remain retarded | Both | Discrete | {same series as for flaps 1 and 5} | Visual / kinesthetic observation of throttle position | | |
| Feel pitch change further | Both | Discrete | {same series as for flaps 1 and 5} | Kinesthetic | | |
| Observe flaps 15 on EICAS | Both | Discrete | {same series as for flaps 1 and 5} | EICAS (bar indicator) | | |
| Verify Flaps 15 | PF | Discrete | {same series as for flaps 1 and 5} | View the position of the flaps lever (pedestal) | | |
| Confirm Flaps 15 | PF | Discrete | {same series as for flaps 1 and 5} | | Verbal - spoken | |

Appendix B – Arrival Task Analysis

| | | | | | | |
|---|------|----------|------------------------------|---|--|--|
| Observe throttles increasing as speed reaches 170 knots | Both | Discrete | 2 s | Visual / kinesthetic observation of throttle position | | |
| Hear additional thrust | Both | Discrete | simultaneous with above step | Auditory | | |
| Feel pitch stabilize | Both | Discrete | simultaneous with above step | Kinesthetic | | |
| Observe speed stabilize at 170 knots | Both | Discrete | simultaneous with above step | PFD (strip along the left) | | |
| Observe throttles stabilize | Both | Discrete | simultaneous with above step | Visual / kinesthetic observation of throttle position | | |
| ATC communication: “United 573 turn left heading 330° and descend to 3,000” | ATC | Discrete | 4 s | Headset | | |
| Radio back to ATC | PNF | Discrete | simultaneous with next step | | Push radio button (at far left / <u>right</u> of glare shield) | |
| Read back clearance “United 573 left turn heading 330° and down to 3,000” | PNF | Discrete | 4 s | | Verbal – spoken | |
| Spin heading select to 330° | PF | Discrete | 2 s | | | |

Turn the Heading knob on MCP until 330 is

Appendix B – Arrival Task Analysis

| | | | | | | |
|-----------------------------|------|----------|---------------------------------------|---|---|--|
| | | | | | the Heading Indicator window. | |
| | | | | | Press the Heading knob / button. | |
| Feel aircraft bank left | Both | Discrete | this and next 3 steps take about 15 s | Kinesthetic | | |
| Feel pitch adjustment | Both | Discrete | see above | Kinesthetic | | |
| Feel throttles increase | Both | Discrete | see above | Visual / kinesthetic observation of throttle position | | |
| Hear an increase in thrust | Both | Discrete | see above | Auditory | | |
| Set MCP altitude to 3,000 | PNF | Discrete | 1 s | | Turn the Altitude Indicator knob on the MCP until 3000 is displayed in the Altitude Indicator window. | |
| Check altitude set to 3,000 | PF | Discrete | 0.5 s | MCP – altitude indicator display | | |
| Point to altitude | PF | Discrete | 1 s | | Point with | |

Appendix B – Arrival Task Analysis

| | | | | | | |
|---|------|----------|-------------------------------|---|--|--|
| | | | | | index finger to the MCP altitude setting | |
| Verbally confirm (state) the altitude setting | PF | Discrete | simultaneous with above step | | Verbal – spoken | |
| Press FLCH | PF | Discrete | 1 s | | FLCH button on the MCP | |
| Observe FMA change from ALT to [FLCH] then FLCH | Both | Discrete | 3 s for this and next 7 steps | PFD (strip along the top) | | |
| Observe throttles retard | Both | Discrete | see above | Visual / kinesthetic observation of throttle position | | |
| Hear a reduction in thrust | Both | Discrete | see above | Auditory | | |
| Feel pitch change | Both | Discrete | see above | Kinesthetic | | |
| Observe pitch on PFD | Both | Discrete | see above | PFD (center) | | |
| Observe altitude changing on altimeter | Both | Discrete | see above | PFD (strip along the right) | | |
| Observe altitude leaving 4,000 feet | Both | Discrete | see above | PFD (strip along the right) | | |
| Verify that speed stays at 170 knots | Both | Discrete | see above | PFD (strip along the left) | | |
| Altitude call out: “4 thousand for 3 thousand” | PNF | Discrete | 2 s | | Verbal | |
| Verify passing altitude | PF | Discrete | 0.5 s | PFD (strip along the | | |

Appendix B – Arrival Task Analysis

| | | | | | | |
|--|------|----------|-------------------------------|---|-----------------|--|
| | | | | right side) | | |
| Confirm passing altitude | PF | Discrete | 0.5 s | | Verbal - spoken | |
| Observe VSI stabilizing in descent | Both | Discrete | 0.5 s | PFD (strip along the right) | | |
| Observe aircraft roll out on new heading | Both | Discrete | 3 s for this and next 9 steps | PFD (center) and NAV | | |
| Feel aircraft bank to wings level | Both | Discrete | see above | Kinesthetic | | |
| Feel pitch adjustment | Both | Discrete | see above | Kinesthetic | | |
| Observe VSI reducing to zero | PF | Discrete | see above | PFD (strip along the right) | | |
| Observe FMA change from FLCH to [ALT] then ALT | Both | Discrete | see above | PFD (strip along the top) | | |
| Observe throttles increasing | Both | Discrete | see above | Visual / kinesthetic observation of throttle position | | |
| Hear additional thrust | Both | Discrete | see above | Auditory | | |
| Feel pitch stabilize | Both | Discrete | see above | Kinesthetic | | |
| Observe speed stabilize | Both | Discrete | see above | PFD (strip along the left) | | |
| Observe throttles stabilize | Both | Discrete | see above | Visual / kinesthetic observation of throttle position | | |

Appendix B – Arrival Task Analysis

| In level flight at 3,000 feet MSL <ul style="list-style-type: none"> • ~12 miles out from airport • On NORCAL Approach Frequency <ul style="list-style-type: none"> • 170 knots • Flaps at 15 • On intercept course to ILS Receive Approach Clearance | | | | | | |
|---|------|----------|-----------------------------|----------------------------|---|--|
| ATC Communication: “United 573 maintain 3,000 feet until established, cleared ILS 28L, 170 knots to the marker, contact tower at OKDUE 120.5” | ATC | Discrete | 7 s | Headset | | |
| Radio back to ATC | PNF | Discrete | simultaneous with next step | | Push radio button (at far left / <u>right</u> glare shield) | |
| Read back clearance “United 573 Maintain 3,000 till established, cleared ILS 28L, 170 knots to the marker, contact tower at OKDUE” | PNF | Discrete | 5 s | | Verbal – spoken | |
| Arm approach by pressing APP button on MCP | PF | Discrete | 1 s | | MCP (APP button in lower right corner) | |
| Tune 120.5 into RTP (good, but don’t select yet) | PNF | Discrete | 2 s | | Radio controls on pedestal | |
| Observe FMA change from: SPD HDG ALT to SPD HDG (LOC) ALT (GS) | Both | Discrete | 0.5 s | PDF (strip across the top) | | |

Appendix B – Arrival Task Analysis

| | | | | | | |
|--|------|----------|--|---|----------------------------|--------------------------------|
| Observe localizer intercept as raw data LOC Magenta Diamond begins to move from edge of display area towards the center of the CDI | Both | Discrete | This step takes 10-20 s; pilots glance to check progress | PFD (center display) | | |
| Tune 131.0 as the standby number in the number 2 RTP (Ramp Control) | PNF | Discrete | 2 s | | Radio controls on pedestal | |
| Call out: “Localizer Alive” | PF | Discrete | 1 s | | Verbal – spoken | |
| Feel aircraft bank left | Both | Discrete | This step and next 5 occur over about 20 s | Kinesthetic | | |
| Feel pitch adjustment | Both | Discrete | see above | Kinesthetic | | |
| Feel throttles increase | Both | Discrete | see above | Visual / kinesthetic observation of throttle position | | |
| Hear an increase in thrust | Both | Discrete | see above | Auditory | | |
| Observe FMA change from: SPD HDG (LOC) ALT (GS) To SPD [LOC] ALT (G/S) To SPD LOC ALT (G/S) | Both | Discrete | see above | PFD (center display) | | |
| Observe heading select move to LOC heading | Both | Discrete | see above | NAV and PFD (FMA) | | I think PF has to dial heading |
| Observe aircraft roll out on new heading | Both | Discrete | This step and next 4 occur over about 10 s | NAV and PFD (lower) | | |

Appendix B – Arrival Task Analysis

| | | | | | | |
|--|------|----------|--|---|--------------------------|---|
| Feel aircraft bank to wings level | Both | Discrete | see above | Kinesthetic | | |
| Feel pitch adjustment | Both | Discrete | see above | Kinesthetic | | |
| Feel throttles reduce and adjust | Both | Discrete | see above | Visual / kinesthetic observation of throttle position | | |
| Observe LOC raw data Magenta diamond stabilize at center of CDI | Both | Discrete | see above | PFD (center) | | |
| Observe Glideslope intercept as raw data G/S magenta diamond moves down from the top of the display area towards center of CDI | Both | Discrete | This step takes 10-20 s; pilots glance to check progress | PFD (center) | | timing depends on distance from airport |
| Call out: “Glideslope is alive.” | PF | Discrete | 1 s | | Verbal – spoken | |
| Observe the raw data G/S Magenta Diamond approach ¼ dot from the center of the CDI | PF | Discrete | 0.5 s | PFD (center) | | |
| Command “Flaps 20” | PF | Discrete | 1 s | | Verbal – spoken | |
| Resist throttles from increasing | PF | Discrete | simultaneous with above step | | Throttles on pedestal | |
| Identify Flaps 20 speed | PF | Discrete | 1 s | PFD (strip along the left) | | Remember the correct speed |

Appendix B – Arrival Task Analysis

| | | | | | | |
|---|------|----------|--|---|---|--|
| | | | | | Push IAS button / knob on MCPTurn inner knob until the correct speed is displayed on the IAS window | |
| Set Flaps 20 speed | PF | Discrete | 2 s | | | |
| Verify that the Flaps 20 speed is correctly set | PF | Discrete | 0.5 s | PFD (magenta box should be around the Flaps 20 speed) | | |
| Feel throttles move towards idle | PF | Discrete | simultaneous with previous 2 steps | Visual / kinesthetic observation of throttle position | | |
| Select flaps to 20 | PNF | Discrete | 2 s | | Flaps lever on pedestal | |
| Hear flap handle move into flaps 20 detent | Both | Discrete | simultaneous with above step | Auditory | | |
| Feel pitch change to flaps 20 attitude | Both | Discrete | as aircraft slows; this would be subsumed into slowing steps above | Kinesthetic | | |
| Observe flaps 20 on EICAS | Both | Discrete | This takes about 5 s after flap handle moved. | EICAS (bar indicator) | | |
| Announce “Flaps 20” | PNF | Discrete | 1 s | | Verbal – | |

Appendix B – Arrival Task Analysis

| | | | | | | |
|---|------|----------|---|---|--|--|
| | | | | | spoken | |
| Verify Flaps 20 | PF | Discrete | 0.5 s | View the position of the flaps lever (pedestal) | | |
| Confirm Flaps 20 | PF | Discrete | 1 s | | Verbal - spoken | |
| Observe FMA change from: SPD LOC ALT (G/S) To: SPD LOC [G/S] To: SPD LOC G/S | Both | Discrete | This happens as glideslope is captured. So, this step and next 2 occur simultaneously over about 5 s. | PFD (strip along the top) | | |
| Observe Glideslope raw data Magenta diamond stabilize at center of CDI | Both | Discrete | see above | PFD (center) | | |
| Call out: “Glideslope intercept, Set Touch Down Zone Elevation” | PF | Discrete | see above | | Verbal | |
| Look up Touch Down Zone Elevation | PNF | Discrete | 1 s | Approach chart | | |
| Set Touch Zone Elevation in MCP altitude window (13’ = 100 on the MCP) | PNF | Discrete | 3 s | | Turn the altitude indicator knob on the MCP until the altitude indicator window displays 100 | |

Appendix B – Arrival Task Analysis

| | | | | | | |
|---|------------|----------|--|---|-----------------|--|
| Confirm Touch Down Zone Elevation | PF | Discrete | 0.5 s | Altitude indicator on MCP | | |
| Verify Touch Down Zone Elevation | PF | Discrete | 1 s | | Verbal | |
| Aircraft on Glideslope at 3,000 feet MSL | | | | | | |
| <ul style="list-style-type: none"> • 9 miles out from airport • On NORCAL Approach Frequency • Flaps are at 20 speed 170 | | | | | | |
| Feel throttles adjust to flap 20 speed 170 on the glideslope | PF | Discrete | several seconds of smooth, continuous autopilot adjustment | Visual / kinesthetic observation of throttle position | | |
| Hear engines adjust to flap 20 speed 170 on the glideslope | Both | Discrete | several seconds of smooth, continuous autopilot adjustment | Auditory | | |
| 2,500 AGL on Radio Altimeter displayed on PFD | | | | | | |
| “2,500 foot audio call out” | | | | | | |
| ~8.5 miles form airport | | | | | | |
| 2,500 foot call out | Automation | Discrete | 2 s | Auditory | | |
| Call out "Check Altimeter set to 29.84 inches." | PF | Discrete | 2 s | | Verbal - spoken | |
| Verify primary altimeter pressure settings | Both | Discrete | 1 s | PFD | | |
| Verify standby altimeter setting | CAP | Discrete | 1 s | Standby altimeter | | |
| Verbally confirm “Altimeters set 29.84 inches” | Both | Discrete | 2 s | | Verbal - spoken | |
| Call out "Check Decision Height | PF | Discrete | 2 s | | Verbal - | |

Appendix B – Arrival Task Analysis

| | | | | | | |
|---|------|----------|---|--|--|--|
| is 213 feet barometric." | | | | | spoken | |
| Verify decision height | Both | Discrete | 1 s | PFD | | |
| Verbally confirm "Decision altitude is 213 feet barometric" | PF | Discrete | 3 s | | Verbal - spoken | |
| • ~1.5 miles from marker • The task sequence listed for this event takes approximately 10 s to complete. | | | | | | |
| Says, "Gear Down; final descent check list " | PF | Discrete | 2 s | | Verbal – spoken | |
| Place Gear handle to down | PNF | Discrete | 2 s | | Gear lever on forward instrument panel | |
| Hear Gear handle move to down position | Both | Discrete | simultaneous with above step | Auditory | | |
| Hear gear doors open | Both | Discrete | 2 s | Auditory | | |
| Hear gear move into slip stream | Both | Discrete | several seconds | Auditory | | |
| Feel deceleration of aircraft | Both | Discrete | simultaneous with above step | Kinesthetic | | |
| Resist throttles from increasing | PF | Discrete | simultaneous with above step | | Throttles on pedestal | |
| Calculate target landing speed: $V_{ref} + 5$, plus gusting wind factor (1. identify V_{ref} , 2. do mental calculation) | PF | Discrete | 4 s to calculate and discuss, confirm among pilots. | PFD - Find the speed that corresponds to V_{ref} on the left strip | | Perform mental calculations to identify target landing speed |
| Set MCP speed to target landing speed | PF | Discrete | 2 s | | Turn inner knob until landing speed is displayed in the IAS window | Remember calculated landing speed |

Appendix B – Arrival Task Analysis

| | | | | | | |
|---|------|----------|--|---|-----------------------------------|--|
| Verify landing speed | PNF | Discrete | confirm after setting takes 0.5 s | View the PFD and the IAS window | | Perform mental calculations to check the math for target landing speed |
| Verbally confirm landing speed | PNF | Discrete | 1 s to speak | | Verbal | |
| Arm Speed Brake | PF | Discrete | 1 s | | Air Speed Brake lever on pedestal | |
| Feel pitch change | Both | Discrete | 2 s | Kinesthetic | | |
| Feel throttles adjust to accommodate gear down flaps 20 on glideslope | PF | Discrete | continuous with gear lowering steps | Visual / kinesthetic observation of throttle position | | |
| Hear Engines adjust to accommodate gear down flaps 20 on glideslope | Both | Discrete | continuous with gear lowering steps | Auditory | | |
| Feel Speed Brake move into armed detent | PF | Discrete | simultaneous with 523 (arm speed brakes) | Kinesthetic | | |
| Hear Speed Brake move into armed detent | Both | Discrete | simultaneous with 523 (arm speed brakes) | Auditory | | |
| Observe “Speed Brake armed” on EICAS | Both | Discrete | 1 s | EICAS (text indication) | | |
| Observe “Gear Down” on EICAS | Both | Discrete | 1 s | EICAS (text box) | | |
| Call for the Final Descent Checklist | PF | Discrete | redundant with 508 | | Verbal | |
| Press CHKL on the Display Select Panel (DSP) | PNF | Discrete | 1 s | | CHKL on Display Select Panel | |

Appendix B – Arrival Task Analysis

| | | | | | | |
|---|------|----------|---|--|-------------------------|---|
| Read aloud and verify items on the Final Descent Check are complete | PNF | Discrete | 5-10 s, depending on flap setting (actual vs. planned and any discussion) | | Verbal | |
| Cabin notification – complete | PNF | Discrete | see above | | | From memory |
| Landing gear – down, green light | PNF | Discrete | see above | EICAS – text box | | |
| Speed brakes – armed | PNF | Discrete | see above | EICAS – text indication | | |
| Speed brakes – armed: verify | PF | Discrete | see above | EICAS indication and speed brakes lever position | | |
| Speed brakes – armed: confirm | PF | Discrete | see above | | Verbal | |
| Flaps - __30__planned, __20__indicated (NOTE: this is the last step in the checklist, but it can't be confirmed until the flaps are in the final landing position) | PNF | Discrete | see above | EICAS – flaps setting, Flaps lever on pedestal | | Remember the planned final flaps setting from the approach briefing |
| Command flaps 25 “Flaps 25” | PF | Discrete | 1 s | | Verbal – spoken | |
| Select flaps 25 | PNF | Discrete | 2 s | | Flaps lever on pedestal | |
| Feel flaps handle move around reverse gate on flap handle track | PNF | Discrete | see above | Kinesthetic | | |
| Hear flap handle move around | Both | Discrete | see above | Auditory | | |

Appendix B – Arrival Task Analysis

| | | | | | | |
|---|------|----------|---|---|----------------------------|--|
| reverse gate on flap handle track | | | | | | |
| Feel throttles adjust to accommodate gear down flaps 25 on glideslope | PF | Discrete | simultaneous with above step | Visual / kinesthetic observation of throttle position | | |
| Hear Engines adjust to accommodate gear down flaps 25 on glideslope | Both | Discrete | simultaneous with above step | Auditory | | |
| Observe flaps 25 on EICAS | Both | Discrete | about 5 s after selecting flaps 25; observation takes 0.5 s | EICAS (bar indicator) | | |
| Verify Flaps 25 | PF | Discrete | 0.5 s | View the position of the flaps lever (pedestal) | | |
| Confirm Flaps 25 | PF | Discrete | 1 s | | Verbal - spoken | |
| Select 120.5 into “Active windows” on RTP | PNF | Discrete | 1 s | | Radio controls on pedestal | |
| Command flaps 30 “Flaps 30” | PF | Discrete | 1 s | | Verbal - spoken | |
| Select flaps 30 | PNF | Discrete | 2 s | | Flaps lever on pedestal | |
| Feel flaps handle move around along the flap handle track | PNF | Discrete | simultaneous with above step | Kinesthetic | | |
| Hear flap handle move around along the flap handle track | Both | Discrete | simultaneous with above step | Auditory | | |

Appendix B – Arrival Task Analysis

| | | | | | | |
|---|------|----------|---|---|---|--|
| Feel throttles adjust to accommodate gear down flaps 30 on glideslope | PF | Discrete | simultaneous with above step | Visual / kinesthetic observation of throttle position | | |
| Hear Engines adjust to accommodate gear down flaps 30 on glideslope | Both | Discrete | simultaneous with above step | Auditory | | |
| Observe flaps 30 on EICAS display | Both | Discrete | about 7 s after selecting flaps 30; observation takes 0.5 s | EICAS – bar indicator | | |
| Verify Flaps 30 | PF | Discrete | 0.5 s | View the position of the flaps lever (pedestal) | | |
| Confirm Flaps 30 | PF | Discrete | 0.5 s | | Verbal - spoken | |
| Radio to SFO Tower | PNF | Discrete | simultaneous with next step | | Push radio button (at far left / <u>right</u> glare shield) | |
| Call SFO tower “SFO Tower United 573, OKDUE for 28L” | PNF | Discrete | 3 s | | Verbal – spoken | |
| ATC Communications: “United 573 cleared to land runway 28L” | Both | Discrete | 3 s | Headset | | |
| Radio to SFO Tower | PNF | Discrete | simultaneous with next step | | Push radio button (at far left / <u>right</u> glare shield) | |
| Read back clearance “United 573 cleared to land runway 28L” | PNF | Discrete | 3 s | | Verbal - spoken | |

Appendix B – Arrival Task Analysis

| | | | | | | |
|---|------|--------------|-------------------------------------|-----|--|--|
| | | | | | Taxi - Switch at the front of the overhead panel | |
| Place Taxi light switch to on | CAP | Discrete | 1 s | | | |
| “Final Descent Checklist complete” | PNF | Discrete | 3 s | | Verbal - spoken | |
| Roger, checklist complete” | PF | Discrete | 2 s | | Verbal - spoken | |
| 1,450 feet on Radio Altimeter LAND 3 on PFD | | | | | | |
| ~4.35 miles from airport | | | | | | |
| Observe FMA change from SPD LOC G/S | | | | | | |
| To: SPD LOC (ROLLOUT) [G/S] (FLARE) | Both | Discrete | 0.5 s glance | PFD | | |
| “Land 3 Rollout and Flare Armed” | PNF | Discrete | 2 s | | Verbal - spoken | |
| Watch for Lighting System | PNF | Intermittent | quick glances, almost continuous | OTW | | |
| Monitor ILS Raw Data | PNF | Intermittent | quick glances, almost continuous | PFD | | |
| Monitor ILS Raw Data | PF | Continuous | quick glances, almost continuous | PFD | | |
| 1,000 feet on Radio Altimeter | | | | | | |
| 3 miles from airport | | | | | | |

Appendix B – Arrival Task Analysis

| | | | | | | |
|--|------------|--------------|----------------------------------|---|-----------------|--------|
| Visual scan of flight deck | PNF | Intermittent | quick glances, almost continuous | PFD, NAV, EICAS, location of pedestal controls and landing gear | | |
| Verbal confirmation “1,000 feet - Instruments Cross Checked” | PNF | Discrete | 2 s | | Verbal - spoken | |
| “Runway 28L Cleared to Land” | PF | Discrete | 2 s | | | memory |
| 500 feet on Radio Altimeter | | | | | | |
| IMC 1.5 miles from airport | | | | | | |
| Monitor altimeter to see when crossing 500 feet | PNF | Intermittent | quick glances, almost continuous | PFD | | |
| Call out “500 feet” | Automation | Discrete | 1 s | | Verbal - spoken | |
| Call out “Final Flaps 30” | PF | Discrete | 1 s | | Verbal - spoken | memory |
| Verify Flaps 30 on upper EICAS | Both | Discrete | 0.5 s glance | Upper EICAS | | |
| Verbally confirm "Flaps 30" | PNF | Discrete | 1 s | | Verbal - spoken | |
| 100 feet above DA (313 feet MSL) | | | | | | |
| 1 mile from airport IMC | | | | | | |
| Monitor altimeter to see when 100 feet above decision altitude | PNF | Intermittent | quick glances, almost continuous | PFD | | |
| Call out "100 feet above decision height" | PNF | Discrete | 2 s | PFD | | |
| Look for the sequence flashing lights on the runway | PNF | Intermittent | quick glances, almost | OTW | | |

Appendix B – Arrival Task Analysis

| | | | | | | |
|--|------|--------------|----------------------------------|-----|-------------------------|-----------------|
| | | | continuous | | | |
| Call out "I see the strobes" (or "Rabbit in sight" or "I've got the Rabbit") when the PNF sees the Sequence Flashing Lights. | PNF | Discrete | 1 s | | Verbal - spoken | |
| Call out "Approaching decision height" | PNF | Discrete | 2 s | | Verbal - spoken | |
| 90 feet above DA (~300 feet MSL) | | | | | | |
| ~1mile from airport VMC | | | | | | |
| Look for runway | PNF | Discrete | quick glances, almost continuous | OTW | | |
| Announce "Runway in sight" | PNF | Discrete | 1 s | | Verbal - spoken | |
| "Runway in sight. Landing" | PF | Discrete | 1 s | | Verbal - spoken | Decision making |
| Disengage Auto Pilot (Button on outboard Yoke handle) | PF | Discrete | 0.5 s | | Button on yoke | |
| Trim as necessary | PF | Intermittent | half second, or less, bursts | | Trim adjustment on yoke | |
| Look for PAPI lighting system | Both | Intermittent | quick glances, almost continuous | OTW | | |
| Observe PAPI lighting system | Both | Intermittent | quick glances, almost continuous | OTW | | |
| Monitor and observe guidance on PFD | Both | Intermittent | quick glances, almost continuous | PFD | | |

Appendix B – Arrival Task Analysis

| | | | | | | |
|--|------|---|--|---|-------------------------|--|
| Observe airspeed | Both | Intermittent | quick glances, almost continuous | PFD | | |
| Observe ILS Raw Data | Both | Intermittent | quick glances, almost continuous | PFD | | |
| Apply Rudder and Ailerons to compensate for cross wind component | PF | Continuous | as needed | | Rudder pedals / yoke | |
| Feel AUTO Throttles adjust as attitude changes | Both | Continuous | | Kinesthetic (PF has hand on throttles) | | |
| Observe Runway alignment | Both | Intermittent | quick glances, almost continuous | OTW | | |
| 50 feet Radio Altimeter | | | | | | |
| Over runway | | | | | | |
| Adjust pitch up ~2° to 3° to reduce rate of descent | PF | Discrete | 3-5 s of gradual pull on yoke | Yoke | | |
| 30 feet Radio Altimeter | | | | | | |
| Over runway | | | | | | |
| Look all the way down the runway | PF | Continuous (almost continuous visual attention for last 50 feet of altitude above runway) | ~10 s | OTW | | |
| Fly aircraft over the runway | PF | Continuous | simultaneous with above step | | Rudder for nose | |

Appendix B – Arrival Task Analysis

| | | | | | | |
|--|------|------------|--|-------------------------------|--|------------------------|
| | | | | | alignment, yoke for pitch | |
| Moderate the rate of AUTO Throttle movement towards idle | PF | Continuous | simultaneous with above step | | Throttles on pedestal (slow their movement to idle) | |
| Hold cockpit at a steady height above the runway and allow the main landing gear to settle onto the runway | PF | Discrete | simultaneous with above step | | Yoke - maintain back pressure | |
| Ensure throttles are at idle | PF | Discrete | last 2-3 s before touchdown | Throttles on pedestal | | |
| Feel slight deceleration as main gear touches down | Both | Discrete | 1 s | Kinesthetic | | |
| Observe Speed Brake handle deploy | Both | Discrete | simultaneous with touchdown of main wheels | Speed brake lever on pedestal | | peripheral vision only |
| Hear AUTO Throttle disconnect | Both | Discrete | 0.5 s | Auditory click | | |
| Feel the aircraft settle onto main landing gear | Both | Discrete | 1-2 s duration | Kinesthetic | | |
| Apply reverse thrust | PF | Discrete | about 3.5 s to go from idle to full reverse thrust | | Reverse thrust levers on pedestal (lift and pull back) | |
| Fly nose of aircraft onto the runway | PF | Discrete | 5 s from main wheels touching down | | rudders (pedals) and yoke | |
| Feel aircraft attitude change as the nose settles onto runway | Both | Discrete | simultaneous with above step | Kinesthetic | | |

Appendix B – Arrival Task Analysis

| | | | | | | |
|--|------|--------------|----------------------------------|----------------------|---|---|
| Hear nose wheel touch down | Both | Discrete | 0.5 s | Auditory (squeak) | | |
| Feel aircraft decelerate as reverse thrust takes effect | Both | Discrete | 20-30 s for whole deceleration | Kinesthetic | | |
| Observe ground speed | Both | Intermittent | simultaneous with above step | PFD | | |
| Feel aircraft decelerate as reverse thrust takes effect | PF | Discrete | simultaneous with above step | Kinesthetic | | |
| Reduce reverse thrust to stow Thrust reversers by 60 knots | PF | Discrete | about 5 s to return to idle | | Reverse thrust levers on pedestal (put back to original position) | |
| 60 knots ground speed | | | | | | |
| Observe ground speed - reaches 60 knots | PNF | Discrete | quick glances, almost continuous | PFD | | mental comparison |
| Announce “60 knots” | PNF | Discrete | 1 s | | Verbal - spoken | |
| De-activate auto-brakes | CAP | Discrete | 1 s | quick of brakes | tactile feel | Auto-brakes activate from touchdown to 60 full stop, unless de-activated by CAP |
| ATC Communications: “United 573 Left turn when able, Contact Ground on 121.8 when clear” | ATC | Discrete | 3 s | Headset | | |

Appendix B – Arrival Task Analysis

| | | | | | | |
|--|-----|--------------|---|-----|--|--|
| Radio to ATC | PNF | Discrete | simultaneous with next step | | Push radio button (at far left / right glare shield) | |
| Read back clearance “United 573 Left when able; switching to 121.8 when clear” | PNF | Discrete | 3 s | | Verbal - spoken | |
| Tune 121.8 in standby number in the number 1 RTP | PNF | Discrete | 1 s | | Radio controls on pedestal | |
| Place left hand on tiller as taxi speed is achieved | CAP | Discrete | 1 s to reach tiller | | Tiller - lever to the left of the CAP's seat | |
| Tap brakes to disengage AUTO Brakes | CAP | Discrete | 1 s to position feet and apply toe pressure | | Upper part of the rudders (pedals) | |
| Observe flow of traffic on Taxiways near Taxiway Tango | CAP | Intermittent | continuous while taxiing | OTW | | |
| Steer the aircraft off of the runway and onto Taxiway Tango | CAP | Continuous | about 3-5 s to exit runway onto T | | Tiller - lever to the left of the CAP's seat | |
| Select 121.8 into “Active windows” or RTP 1 as aircraft clears the runway | F/O | Discrete | 1 s | | Radio controls on pedestal | |
| Turn off landing lights | CAP | Discrete | 1 s | | Light switches on overhead panel | |
| AUTO Throttle switches are selected off | CAP | Discrete | 1 s | | Auto-throttle switches on the MCP | |

Appendix B – Arrival Task Analysis

| | | | | | | |
|--|-----|----------|-----------------------------|---------|--|--|
| Radio to ATC | F/O | Discrete | simultaneous with next step | | Radio button (far left / <u>right</u> of glare shield) | |
| “Ground, United 573 is with you on Taxiway Tango for Gate 82” | F/O | Discrete | 4 s | | Verbal - spoken | |
| ATC Communications: “United 573 Right turn on Alpha cleared to the gate” | ATC | Discrete | 3 s | Headset | | |
| Radio to ATC | F/O | Discrete | simultaneous with next step | | Radio button (far left / <u>right</u> of glare shield) | |
| “United 573 cleared to the gate via Alpha” | F/O | Discrete | 3 s | | Verbal - spoken | |
| 131.0 is selected as the active number the number 2 RTP (Ramp Control) | F/O | Discrete | 3 s | | Radio controls on pedestal | |
| Left Flight Director Switch is selected off | CAP | Discrete | 1 s | | F/D switch on the MCP | |
| Speed brake lever is moved to the down position | CAP | Discrete | 2 s | | Speed brake lever on pedestal | |
| Engine Anti-ice selectors are positioned to off | F/O | Discrete | 2 s | | Overhead panel | |
| Strobe light switch is placed to off | F/O | Discrete | 1 s | | Overhead panel | |
| MCP altitude selector is set to some arbitrarily high number | F/O | Discrete | 2 s | | MCP altitude selector | |
| Right Flight Director Switch is selected off | F/O | Discrete | 1 s | | F/D switch on the MCP | |

Appendix B – Arrival Task Analysis

| | | | | | | |
|---|-----|----------|-----|--|--|--|
| Auto-Brakes Selector is placed to off | F/O | Discrete | 1 s | | Auto brakes selector on the forward instrument panel | |
| Flaps lever is placed in the up position | F/O | Discrete | 2 s | | Flaps lever on pedestal | |
| Transponder mode is placed in the XPNDR position | F/O | Discrete | 1 s | | Radio controls on pedestal | |
| Weather Radar mode selector is placed in the Test position | F/O | Discrete | 1 s | | Weather radar controls on the pedestal | |
| Weather Radar tilt selector is placed in the full up position | F/O | Discrete | 2 s | | Weather radar controls on the pedestal | |
| Taxi to gate | | | | | | |
| Taxi lights on | | | | | | |

CHAPTER 8. APPENDIX C. PHASE 1 CURRENT DAY DEPARTURE SCENARIO TASK ANALYSIS

| Event / Task Description | Operator | Type | Duration | Display / alert | Control | Other info rqmts |
|--|----------|--------------|-----------------------------|-----------------|--|------------------------------------|
| Aircraft is on Taxiway C and is the number 1 aircraft holding short of RW28L | | | | | | |
| Listen to ATC radio transmissions | Both | Continuous | as they occur | Headset | | F/O and CAP must do certain steps. |
| Listen to all ELT's or emergency radio transmissions | Both | Occasionally | as they occur | Headset | | |
| Observe TCAS targets | Both | Intermittent | 3 s | NAV | | |
| Scan for landing traffic out the window | Both | Intermittent | 3 s | OTW | | |
| VNAV page 1 displayed | PF | Continuous | glance to confirm | CDU | | |
| Legs page 1 displayed | PNF | Continuous | glance to confirm | CDU | | |
| ATC communication: "United 373 Position and hold Runway 28L" | ATC | Discrete | 3 s | Headset | | |
| Press radio button | PNF | Discrete | simultaneous with next step | | Push radio button (at far left / right glare shield) | |
| Read back clearance "United 3-7-3 position and hold Runway 28L" | F/O | Discrete | 3 s | | | |
| Captain places both feet on the brakes | CAP | Discrete | as clearance heard | | | |

Appendix C – Departure Task Analysis

| | | | | | | |
|---|------|----------|---------------------------------|--------|--|--|
| Captain places left hand on the tiller | CAP | Discrete | as clearance heard | | | |
| Captain places right hand on throttles | CAP | Discrete | as clearance heard | | | |
| Captain says “Final items” | CAP | Discrete | 1 s | | | |
| Captain releases parking break | CAP | Discrete | 1 s | | | |
| Captain adds power | CAP | Discrete | 2 s | | | |
| Both pilots observe engine indications | Both | Discrete | simultaneous with previous step | | | |
| Both pilots hear engines | Both | Discrete | simultaneous with previous step | | | |
| Both pilots notice aircraft movement | Both | Discrete | 5-10 s | | | |
| Captain arms the autothrottle | CAP | Discrete | 1 s | | | |
| Both pilots observe TCAS traffic on approach | Both | Discrete | 1 s | | | |
| Both pilots observe no traffic on runway | Both | Discrete | 2-second scan | | | |
| F/O completes the BEFORE TAKEOFF CHECKLIST | F/O | Discrete | 2 s | | | |
| “Cabin notification Complete” | F/O | Discrete | 2 s | | | |
| “Transponder TA/RA” | F/O | Discrete | 2 s | | | |
| “Auto-throttles Armed | F/O | Discrete | 1 s to confirm | | | |
| “EICAS Recall Cancel” | F/O | Discrete | 2 s | | | |
| “BEFORE TAKEOFF CHECKLIST is complete” | F/O | Discrete | 2 s | spoken | | |
| Captain confirms and says “Clear on the left” | CAP | Discrete | 2 s | | | |

Appendix C – Departure Task Analysis

| | | | | | | |
|--|------|----------|-----------------------------|--------|--|---|
| F/O confirms and says “Clear on the Right” | F/O | Discrete | 1 s | | | |
| Captain turns on Runway Turnoff and Taxi lights | CAP | Discrete | 1 s | | | |
| F/O turns on Strobe light | F/O | Discrete | 1 s | | | Aircraft is moving during steps 18-33, above. |
| Aircraft crosses the hold short line | | | | | | |
| ATC communication: | | | | | | |
| “United 373 Cleared for take off Runway 28L” | ATC | Discrete | 3 s | | | |
| Read back clearance | F/O | Discrete | simultaneous with next step | | | |
| “United 373 Cleared for take off Runway 28L” | F/O | Discrete | 3 s | | | |
| Aircraft in left turn | | | | | | |
| Captain uses tiller to align the aircraft with the runway centerline | CAP | Discrete | | | | CAP is doing this all along while taxiing onto the runway |
| Captain uses right hand to turn on all three landing lights | CAP | Discrete | 2 s | | | |
| Captain confirms that the F/O is ready | CAP | Discrete | 1 s | spoken | | F/O replies, "Ready." |
| Confirms runway heading and says “Heading 279°” | F/O | Discrete | 1 s | | | |
| Confirms runway heading | CAP | Discrete | 0.5 s | | | |
| Moves heels of feet to deck of cockpit | CAP | Discrete | 0.5 s | | | |
| Advances throttles towards take off position | CAP | Discrete | 2 s | | | |
| Observes EPR gauges are even and ~1.10 EPR | Both | Discrete | 1 s | | | |

Appendix C – Departure Task Analysis

| | | | | | | |
|--|------|---------------------------|----------------------------------|--|--|--|
| Presses either of the TOGA switches | CAP | Discrete | 1 s | | | |
| Monitor Engine indications | Both | intermittently | mainly quick glances until V_1 | | | PNF will be more attentive to EICAS; PF is mainly looking out at runway. |
| Both pilots are mindful of the abort procedures | Both | Continuous | 0 time | | | |
| Both pilots observe FMAs changes from: THR TO/GA (LNAV) TO/GA (VNAV) to: THR REF TO/GA (LNAV) TO/GA (VNAV) | Both | Discrete | 1 s | | | |
| Both pilots observe throttles advance to take off | Both | Discrete | 2 s | | | PNF will be more attentive to EICAS; PF is mainly looking out at runway. |
| Both pilots hear engines spool up | Both | Discrete | simultaneous with previous step | | | |
| Both pilots feel aircraft accelerate | Both | Discrete | 6-8 s | | | |
| Both pilots observe power stabilize at take off | Both | Discrete | 1-2 s as throttles stabilize | | | PNF will be more attentive to EICAS; PF is mainly looking out at runway. |
| Both pilots observe airspeed increase | Both | Continuously intermittent | 20 s | | | PNF will be more attentive to airspeed; PF is mainly looking out at runway, but glancing at airspeed. This is especially true prior to V_1 . |
| Captain moves left hand from tiller to yoke | CAP | Discrete | 1 s | | | at about 60 knots when rudder effective |

Appendix C – Departure Task Analysis

| | | | | | | |
|---|------|------------|-----------------------------|--|--|---|
| Captain uses rudders to hold aircraft on centerline | CAP | Continuous | whole takeoff roll | | | |
| Captain uses ailerons to hold aircraft wings level | CAP | Continuous | whole takeoff roll | | | |
| Aircraft reaches 80 knots | | | | | | |
| F/O confirms all airspeed indicators indicate 80 knots | F/O | Discrete | 2 s | | | |
| F/O confirms all engine indications are normal | F/O | Discrete | 2 s | | | |
| F/O calls out “80 knots thrust set” | F/O | Discrete | 2 s | | | |
| Both pilots observe FMAs change from: THR REF TO/GA (LNAV) TO/GA (VNAV) To: [HOLD] TO/GA (LNAV) TO/GA (VNAV) To: HOLD TO/GA (LNAV) TO/GA (VNAV) | Both | Discrete | 0.5 s | | | PNF will be more attentive to EICAS; PF is mainly looking out at runway. |
| Captain confirms engine indications and the thrust is set | CAP | Discrete | 2 s of intermittent glances | | | PF mainly looking out at runway; will glance at EICAS and airspeed as part of scan pattern. |
| 5 knots (Or two heart beats) prior to V1 | | | | | | |
| F/O calls out “V ₁ ” | F/O | Discrete | 1 s | | | |
| Both pilots confirm all engine indications are normal | Both | Discrete | 1 s | | | |
| Captain places both hands on yoke | CAP | Continuous | 1 s | | | |
| The previous actions are taken just before V ₁ so that they can be completed at V ₁ . | | | | | | |
| V ₁ is a decision point. If the aircraft reaches V ₁ and there is no reason the aircraft won’t fly, the pilots are committed to flying the | | | | | | |

| | | | | | | |
|---|------|------------|--|--|--|---|
| aircraft. At this point the Pilot Roles change from Captain and F/O to PF and PNF. | | | | | | |
| At V_1 the aircraft automatically calls out "V-one." | | | | | | |
| Both pilots are mindful of the engine failure procedures | Both | Continuous | 0 time | | | |
| At V_R | | | | | | |
| Observes speed on speed tape and calls out " V_R " | PNF | Discrete | 1 s | | | several seconds later... |
| Uses yoke to smoothly rotate aircraft at a rate of 2° to 2.5° per second | PF | Discrete | 6-8 s | | | |
| Observes speed on speed tape and calls out " V_2 " | PNF | Discrete | 1 s | | | usually happens during rotation in step above |
| Uses yoke to smoothly rotate aircraft to $\sim 15^\circ$ nose up | PF | Discrete | 6-8 s | | | |
| Feel the aircraft lifting off | Both | Discrete | several seconds | | | |
| Uses flight controls to hold the aircraft's $\sim 15^\circ$ nose up steady | PF | Continuous | | | | |
| Feel the aircraft lifting off | Both | Discrete | several seconds | | | |
| As aircraft begins to lift-off, the landing gear extends. | | | | | | |
| When the main landing gear fully extends, the Autobrakes switch releases from RTO to OFF. | | | | | | |
| Hear the click associated with the Autobrakes switch moving | Both | Discrete | 0.5 s | | | |
| Aircraft lifts off the runway | | | | | | |
| Observe the VSI increasing in the positive direction | Both | Discrete | within a few seconds of lifting off runway | | | |

Appendix C – Departure Task Analysis

| | | | | | | |
|---|------|----------------|---|--|--|---|
| Observe the altitude increasing | Both | Discrete | within a few seconds of the VSI showing a climb | | | |
| Criteria for a positive climb have been met | | | | | | |
| “Positive climb; gear up” | PF | Discrete | 2 s | | | |
| Places gear handle to the up position | PNF | Discrete | 2 s | | | |
| Observes LNAV is armed | Both | Discrete | 1 s | | | |
| Monitor engine indications | Both | intermittently | quick scans | | | Now PF will look a bit less outside and more at PFD for attitude, airspeed. |
| Adjust pitch to hold airspeed between V_2 and $V_2 + 15$ knots | PF | Continuous | | | | |
| At 50 feet radio altimeter | | | | | | |
| Both pilots observe FMAs change from: THR REF HOLD TO/GA (LNAV) TO/GA (VNAV) To: HOLD [LNAV] TO/GA (VNAV) To: HOLD LNAV TO/GA (VNAV) | Both | Discrete | 1 s | | | |
| ATC communication: | | | | | | |
| “United 373 Contact Departure on 135.100” | ATC | Discrete | 4 s | | | |
| Switches 135.100 into the Active window of the Primary RTP | PNF | Discrete | 2 s | | | |
| Read back clearance | PNF | Discrete | simultaneous with next step | | | |

Appendix C – Departure Task Analysis

| | | | | | | |
|---|------|------------|----------------------|--|--|-----------|
| “Departure; United 373 is with you passing 200 feet for 5,000” | PNF | Discrete | 4 s | | | |
| ATC communication: “United 373 Radar Contact” | ATC | Discrete | 2 s | | | |
| At 300 feet AFE Day, Instrument Meteorological Conditions (IMC) | | | | | | |
| Observe OAT | Both | Discrete | 1 s | | | glance |
| Observe roll commands on PFD | Both | Continuous | | | | mainly PF |
| Uses flight controls to follow roll and pitch commands on PFD | PF | Continuous | | | | |
| At 400 feet AFE | | | | | | |
| Both pilots observe FMAs change from: HOLD LNAV TO/GA (VNAV) To: HOLD LNAV [VNAV SPD] To: HOLD LNAV VNAV SPD | Both | Discrete | 1 s | | | |
| Observe Speed bug move to VNAV SPD | Both | Discrete | 1 s | | | |
| Uses flight controls to follow pitch commands on PFD | PF | Continuous | | | | |
| Observe Speed accelerate to VNAV SPD | Both | Continuous | over several seconds | | | mainly PF |
| Observe Speed approach Flaps 1 speed | Both | Discrete | notice as it happens | | | mainly PF |
| 10 knots prior to Flaps 1 speed | | | | | | |
| Command "Flaps 1." | PF | Discrete | 1 s | | | |
| Move Flap handle to Flaps 1 position | PNF | Discrete | 1 s | | | |

Appendix C – Departure Task Analysis

| | | | | | | |
|--|------|-----------------------------|------------------------------|--|--|--|
| Hear Flap Handle move to position 1 | Both | Discrete | simultaneous with above step | | | |
| Adjust pitch to accommodate flap change | PNF | Continuous with flap change | 5 s for flaps to roll up | | | |
| Feel aircraft settle as flaps move from 5 to 1 | Both | Discrete | simultaneous with above step | | | |
| Observe Flap indication on upper EICAS | Both | Discrete | simultaneous with above step | | | |
| Feel aircraft continue to accelerate | Both | Continuous | | | | |
| 10 knots prior to Flaps up speed | | | | | | |
| Command "Flaps up." | PF | Discrete | 1 s | | | |
| Move Flap handle to Flaps up position | PNF | Discrete | 1 s | | | |
| Hear Flap Handle move to position up | Both | Discrete | simultaneous with above step | | | |
| Adjust pitch to accommodate flap change | PNF | Continuous with flap change | 2 s for flaps to roll up | | | |
| Feel aircraft settle as flaps move from 1 to up | Both | Discrete | simultaneous with above step | | | |
| Observe Flap indication removed from upper EICAS | Both | Discrete | simultaneous with above step | | | |
| Observe airspeed increasing | Both | Continuous | | | | |

Appendix C – Departure Task Analysis

| | | | | | | |
|---|------|------------|-----------------------------|--|--|---|
| Feel aircraft continue to accelerate | Both | Continuous | same as 127 | | | |
| At 3,000 feet AFE Speed 250 knots | | | | | | |
| Call for AFTER TAKE OFF CHECKLIST | PF | Discrete | 2 s | | | spoken |
| Press CHKL on DSP | PNF | Discrete | 1 s | | | |
| Use CCD to check Altimeters on ECL | PNF | Discrete | 2 s | | | checking the step that's displayed on ECL |
| Observe all items on ECL are green | PNF | Discrete | 2 s | | | |
| Announce “AFTER TAKE OFF CHECKLIST Complete” | PNF | Discrete | 2 s | | | |
| Place Taxi Light Switch to off | CAP | Discrete | 1 s | | | |
| ATC communication: “United 373 Cleared direct Mendocino climb and maintain FL230” | ATC | Discrete | 4 s | | | |
| Read back clearance | PNF | Discrete | simultaneous with next step | | | |
| “Departure; United 373 direct Mendocino climb to and maintain FL230” | PNF | Discrete | 4 s | | | |
| Set FL230 into the MCP Altitude window | PNF | Discrete | 2 s | | | (use same timing as for approach) |
| Check altitude set to FL 230 (With Point) | PF | Discrete | 1 s | | | |
| Select Legs on FMC-DCU | PF | Discrete | 2 s | | | |
| Observe STINS is the active waypoint at 1L | PF | Discrete | 1 s | | | |
| Line select 3L (ENI) to CDU scratch pad | PF | Discrete | 1 s | | | |
| Line select 1L to place ENI at 1L | PF | Discrete | 1 s | | | |

Appendix C – Departure Task Analysis

| | | | | | | |
|---|------|--------------|------------------------------|--|--|--|
| Observe dashed line on ND indicating route change direct to ENI | PF | Discrete | 1 s | | | |
| Confirm the new proposed active waypoint with PNF | PF | Discrete | 1 s | | | |
| Confirm ENI is at 1L | PNF | Discrete | 1 s | | | |
| Observe dashed line on ND indicating route change direct to ENI | PNF | Discrete | 1 s | | | |
| Press execute button on CDU | PF | Discrete | 1 s | | | |
| Confirm FMA remains in LNAV | Both | Discrete | 1 s | | | |
| Feel aircraft bank to the right | Both | Discrete | 3-4 s | | | depends upon how much turn needed to go direct to ENI |
| Feel pitch adjustment | Both | Discrete | simultaneous with above step | | | |
| Observe aircraft roll out on new Track | Both | Discrete | 3-4 s | | | |
| Feel aircraft bank in appropriate direction | Both | Discrete | simultaneous with above step | | | |
| Feel pitch adjustment | Both | Discrete | simultaneous with above step | | | |
| Observe aircraft proceed to ENI | Both | Intermittent | | | | PF mainly glances at progress until ENI reached |
| ~12,000 feet observe VMC conditions on top | | | | | | |
| Select Terrain off on ND | PF | Discrete | 1 s | | | |
| Select Weather off on ND | PNF | Discrete | 1 s | | | |
| Select Full tilt up on weather radar | PNF | Discrete | 2 s | | | |
| Passing FL180 ~56 miles out from the airport | | | | | | |
| Select STD on Primary altimeters | Both | Discrete | 2 s | | | spoken discussion in parallel about setting altimeters |
| Observe change on PFD and cross | Both | Discrete | 2 s | | | |

Appendix C – Departure Task Analysis

| | | | | | | |
|---|-----|----------|-----------------------------|--|--|---|
| check | | | | | | |
| Set Secondary altimeter to 29.92 | CAP | Discrete | 2 s | | | |
| Turn off exterior lights Landing Lights | CAP | Discrete | 2 s | | | |
| Turn off runway turnoff Lights | CAP | Discrete | 1 s | | | |
| Select NO Smoking Cabin sign light to OFF | CAP | Discrete | 1 s | | | |
| Select NO Smoking Cabin sign light to ON | CAP | Discrete | 1 s | | | signal to flight attendants that it's ok to begin service |
| ATC communication: “Departure, United 373; Do you have any ride reports on climb out?” | CAP | Discrete | 3 s | | | |
| "United 373, No reports all morning, Contact Oakland Center on 127.8” | PNF | Discrete | 3 s | | | |
| Tune 127.8 as the standby number into the number 1 RTP | PNF | Discrete | 2 s | | | |
| Select 127.8 into “Active windows” or RTP | PNF | Discrete | 1 s | | | |
| “Oakland, United 373 is passing 19.5 for 230, Any ride reports?” | PNF | Discrete | 4 s | | | |
| “United 373, radar contact, no complaints” | ATC | Discrete | 2 s | | | |
| Selects Passenger Seat Belt sign to OFF | CAP | Discrete | 2 s | | | |
| Selects PA on Audio select panel | PNF | Discrete | 1 s | | | |
| Makes PA announcement | PNF | Discrete | simultaneous with next step | | | |
| Announcement: "Ladies and gentlemen...." | PNF | Discrete | 20-30 s | | | |
| ATC communication: “Oakland Center; United 373 is passing 215 for 230 looking for higher” | PNF | Discrete | 3 s | | | a minute or so after last ATC radio call |

Appendix C – Departure Task Analysis

| | | | | | | |
|--|------|----------|------------------------------|--|--|--|
| “United 373, Maintain FL230 for traffic” | ATC | Discrete | 3 s | | | |
| “Roger, Maintain FL230” | PNF | Discrete | 2 s | | | |
| Observe altitude passing 22,000 feet | Both | Discrete | 1 s | | | |
| Altitude call out: “Passing 22 thousand for 230” | PNF | Discrete | 3 s | | | |
| Confirm passing altitude | PF | Discrete | 0.5 s | | | |
| Observe VSI reducing to zero | PF | Discrete | 1 s | | | |
| Observe FMA change from VNAV SPD to [ALT] then ALT | Both | Discrete | 1 s | | | |
| Observe speed window on MCP open to current speed | Both | Discrete | 1 s | | | |
| Observe throttles retarded | Both | Discrete | 2-3 s | | | |
| Feel pitch change | Both | Discrete | simultaneous with above step | | | |
| Hear thrust reduce | Both | Discrete | simultaneous with above step | | | |
| Feel pitch stabilize | Both | Discrete | simultaneous with above step | | | |
| Observe speed stabilize | Both | Discrete | simultaneous with above step | | | |
| Observe throttles stabilize | Both | Discrete | 1 s | | | |
| Aircraft is at FL230 | | | | | | |

**CHAPTER 9. APPENDIX D. PHASE 1 PRESENTATION DELIVERED TO THE PILOT
FOCUS GROUP**

**DEFINING NEXTGEN
OPERATIONS FOR
SUPER DENSITY OPERATIONS**

Angelia Sebok
Alion Science and Technology

Becky Hooey
San Jose State University Research Foundation

Today's Agenda

- Introductions
- Research Goal
- Overview of NASA's Super Density Operations Program
- NextGen Arrivals
 - Nominal
 - Off-nominal
- NextGen Departures
 - Nominal
 - Off-nominal
- Wrap-up

Research Goal

Present our vision of NextGen Operations and solicit your feedback.

Brainstorm to create a list of potential 'off-nominal' events

Rate off-nominal events for severity of consequences

- Severity of impact on safety
- Severity of impact on system efficiency

What do we mean by “off-nominal” ?

Off-nominal events may range from 'less-likely but necessary' operations (i.e., weather and windshear events) to very rare events (i.e, partial or full equipment failures).

| Off-nominal Continuum | Off-nominal Event |
|--|--|
| Less likely  Very Rare Events | Conflict Alert |
| | Unpredicted weather events |
| | Sudden turbulence or wind-shear |
| | Aircraft deviates from assigned trajectory |
| | Security Breach |
| | Equipment Failure |

ASDO Background

ASDO Goals

- Enable high-efficiency trajectory-based operations in super dense and regional/metroplex airspace
- Produce systems that are safer, more efficiently used by the operator, more robust to errors and inadvertent misuse, and more likely to bridge the gap from existing systems to future systems

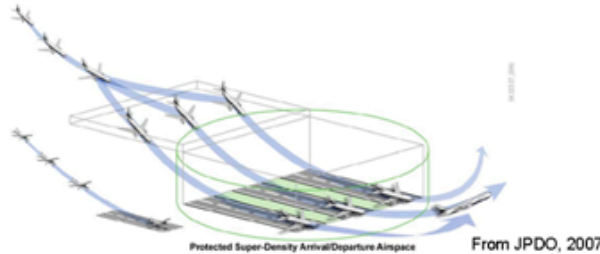

Project Rationale

The transition phase of flight (10,000' to surface) is a period of high-risk exposure, complexity and operator workload, particularly in ASDO operations given reduced aircraft separation and additional monitoring requirements

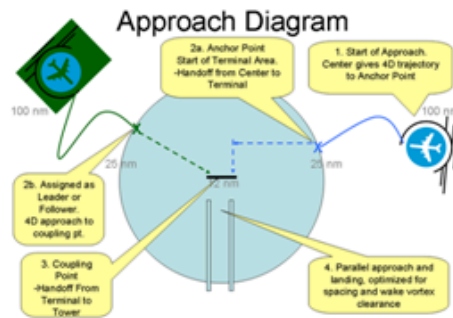

Elements of NextGen Operations

- *4-D trajectory based operations* – aircraft will be assigned 4D trajectories and required to meet path and time requirements. FMS may be upgraded to include a time element.
- *Tailored arrivals and/or Continuous Descent / Ascent* – for ecological and economic reasons, leveling-off flight will be limited to cruise phase with highly efficient arrival trajectories from cruise altitude to runway threshold.
 - Tailored by ATC through speed, altitude, and route constraints
 - Delivered by datalink as a single clearance before TOD
 - Loaded into and flown by FMS
 - Compatible with aircraft type and expected configuration
 - Allow continuous, near idle descent, when possible
 - Customized by an en-route descent advisor to meet sequence and schedule constraints, avoid conflicts, avoid weather, terrain, and restricted airspace
 - Waypoints may be dynamically changing
- *Datalink communication with ATC* – rather than voice communication, communication will be electronic, visual, and text-based (like instant messaging or e-mail)

Elements of NextGen Operations

- *Closely Spaced Parallel Approaches* –
 - Runways separated by 750 ft in IMC conditions.
 - Aircraft paired based on schedule, destination, aircraft performance characteristics, and cross-winds.
 - Paired aircraft fly approaches with integrated coupled FMS and automated speed control algorithms to maintain assigned time-based spacing
 - Pilot approves engagement of coupling
 - Pilots to monitor a traffic display with wake vortex predictions and wake hazards



Elements of NextGen Operations

- *Flight decks will be equipped with displays of:*
 - *Wake vortex* real-time data and predictions
 - *Weather*
 - *Traffic*
 - *Terrain*
 - *Electronically-generated out-the-window view (with highway-in-the-sky displays and real-time data sensing)*

- *Lower decision height (100ft)*

- *Uplinked taxi clearance will be provided before the aircraft lands*

- *Mixed equipment operations* – many different aircraft with many different capabilities will mean prioritized flights, perhaps segmented airspace or time slots. Has the potential for blunders into airspace, pilot or ATM errors on aircraft capabilities

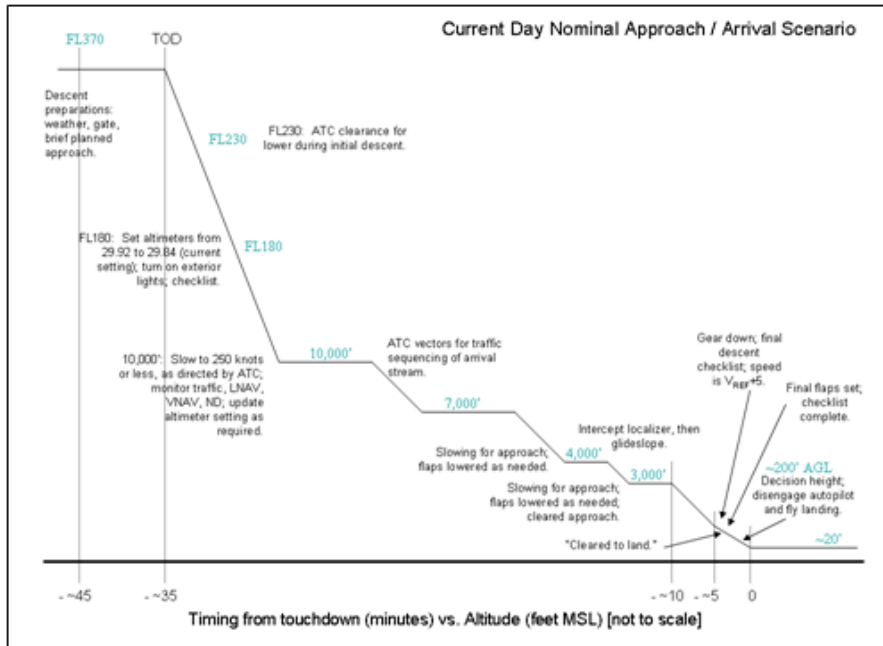

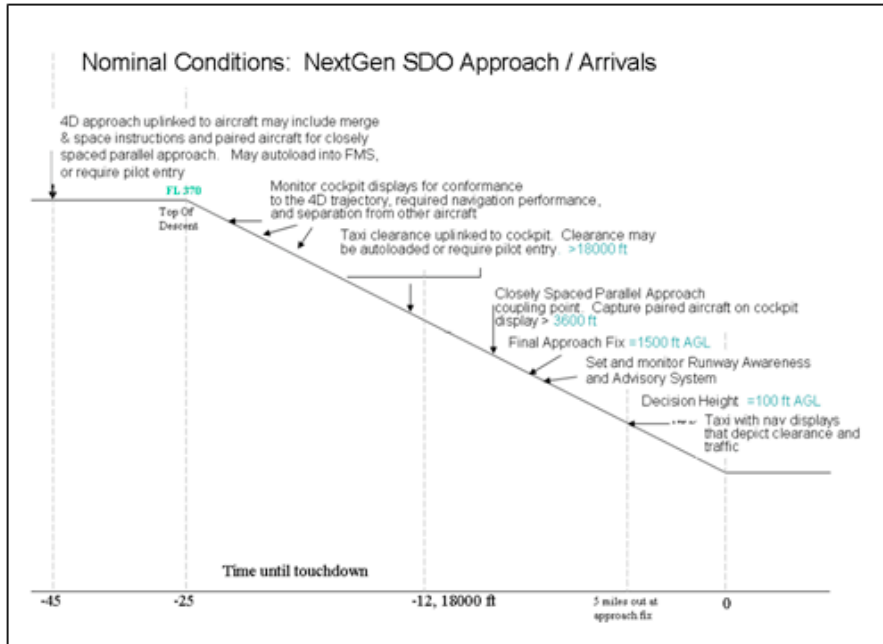

Identifying Off-Nominal Events

- What changes in the environment could alter the nominal procedures?
- What errors could a pilot make?
- What errors could other agents make?
 - ATC
 - Other pilots
- How could the automation fail or mislead a pilot?

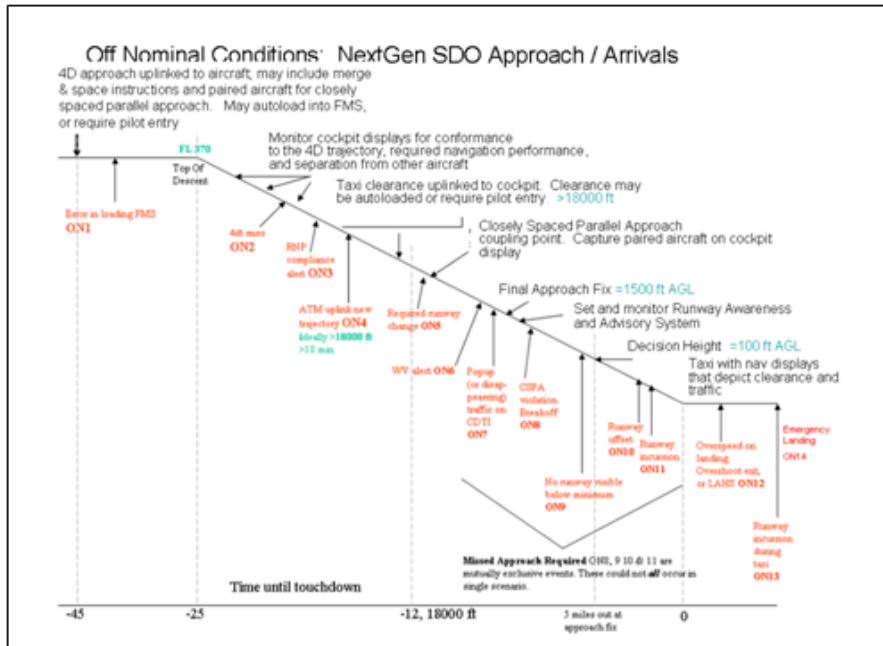
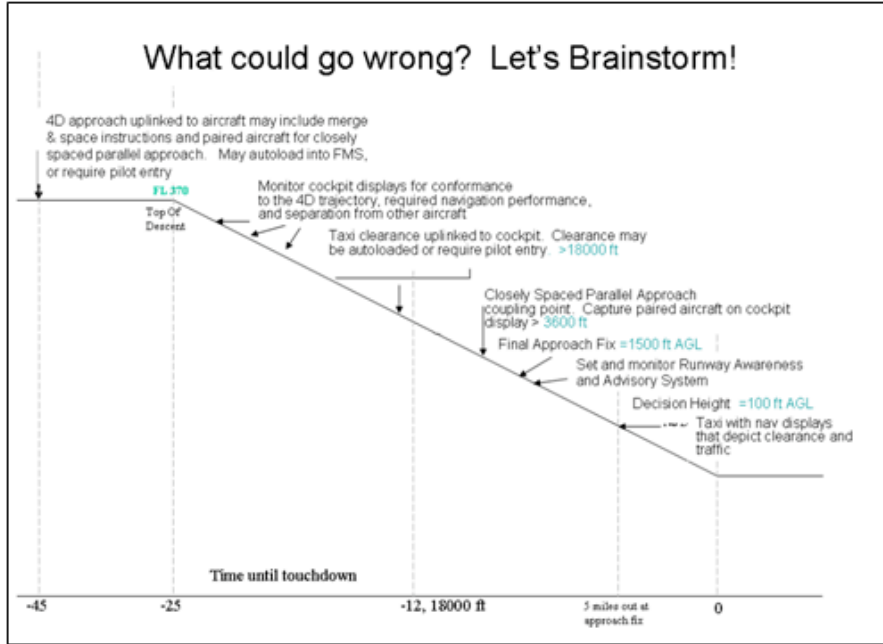

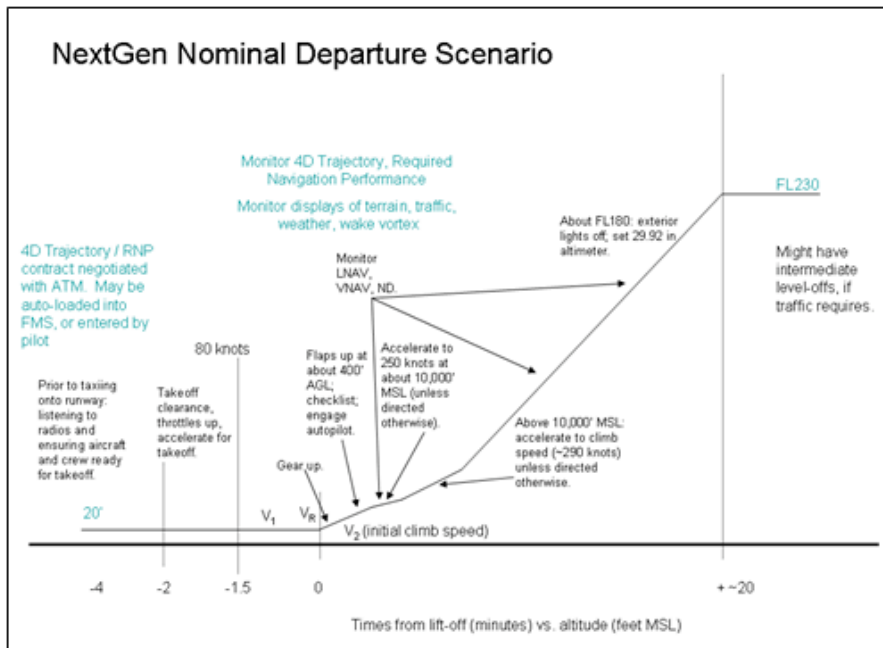
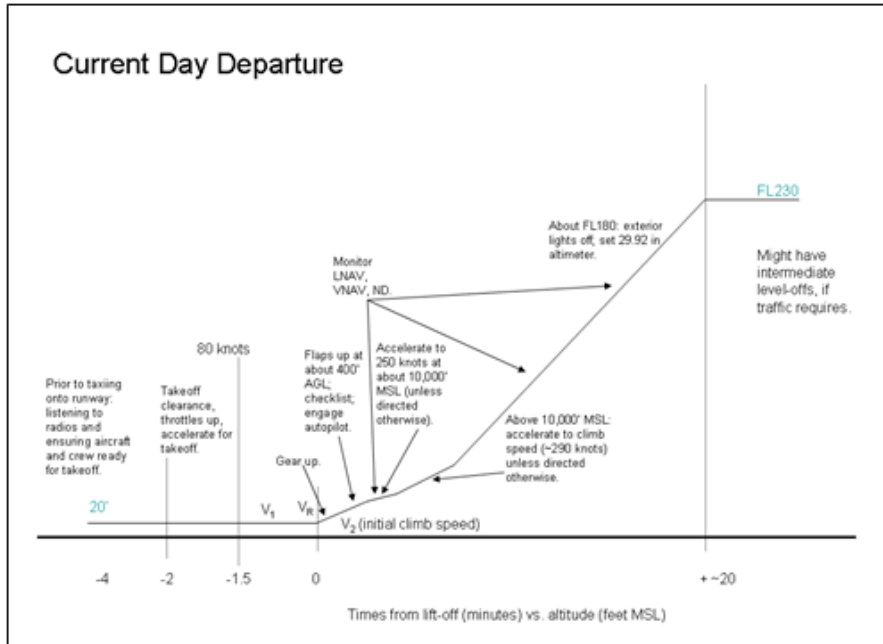

Identifying Off-Nominal Events

- What can go wrong in the environment?
- What errors could a pilot make?
- What errors could other agents make?
 - ATC
 - Other pilots
- How could the automation fail or mislead a pilot?

What could go wrong? Let's Brainstorm!

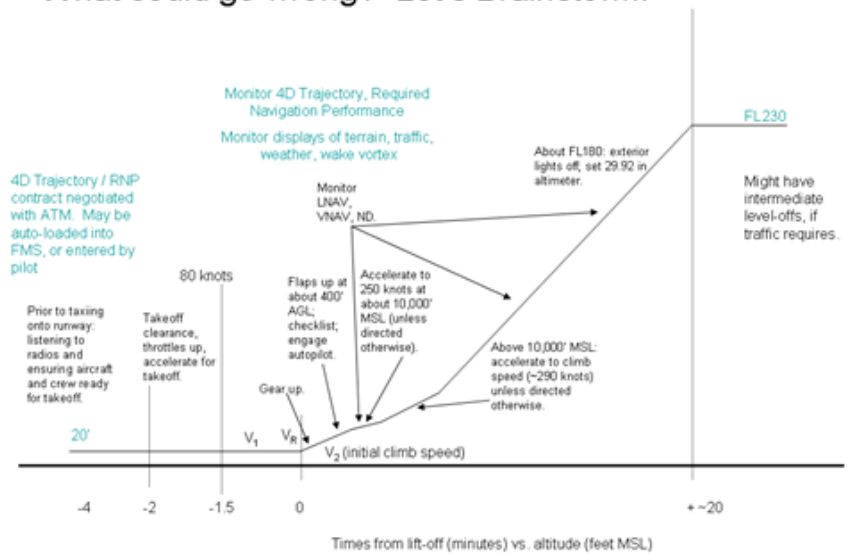

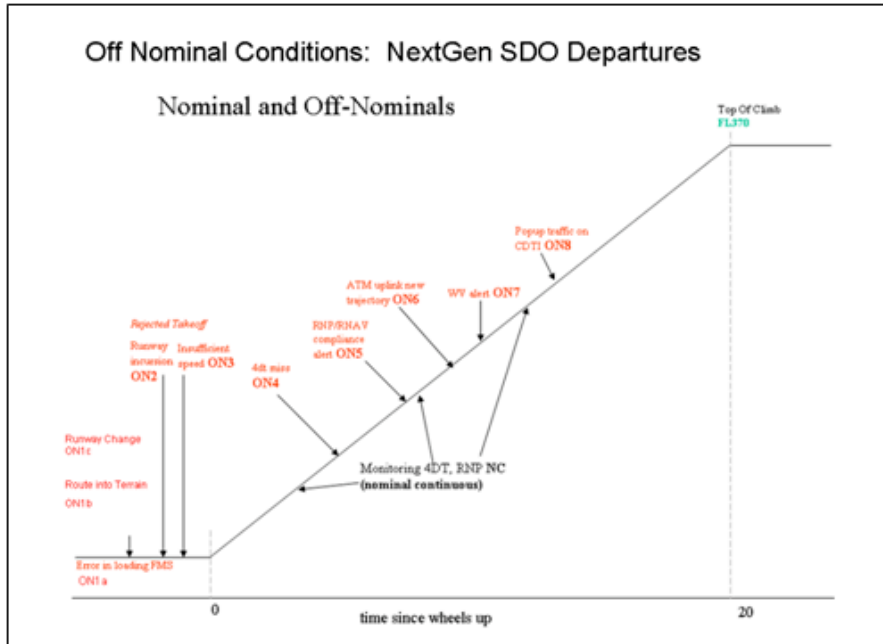

Request for Input

Rate off-nominal events for severity of consequences

- Severity of impact on safety
- Severity of impact on system efficiency

Off Nominal Conditions: NextGen SDO Approach / Arrivals

| Contributing factors Off-nominal Occurrence | Environment (i.e., sudden turbulence or windshear) | Management Interaction with other humans (e.g., pilot-pilot or pilot-ATC) | Human Pilot Error | Machine Automation errors |
|---|---|--|--|--|
| ON4 – ATIS Upload new trajectory | Thunderstorm or icing conditions exist along the new path Insufficient time exists for a new path plan to be developed and implemented | ATC uploads an incorrect new lead aircraft, an incorrect trajectory, incorrect times, or an incorrect runway The upload is not completed in a timely manner, causing the aircraft to encroach on the lead aircraft / other airspace | Pilot fails to accept the new trajectory Data entry error Failure to fly aircraft while interacting with ATC on the new trajectory Pilot does not notice that LNAV / heading select are in the wrong mode | Predictions of uncertainty requires automation Degradation of navigation systems prevent the new trajectory from being implemented Automation is not able to follow the new trajectory |
| ON5 – runway change required | Crosswinds Tailwind >10 knots Thunderstorms, icing, rain/snow "Worms on runway" Fog Insufficient time to upload the path and engage the new ILS Initially-planned runway out of service | Uplink the wrong path Select the wrong path ATC selects a runway that is not appropriate for the aircraft (too short, inappropriate surface for environment, taxiways too narrow) NOTEMS are not up-to-date ATM is not aware of crew certification (e.g., not certified to land in those conditions) | Pilot fails to upload the changes and engage the ILS in sufficient time Pilot does not notice that the runway is incompatible with the aircraft and environment Pilot fails to notice the (up to date) NOTEMS | ILS is out of service Aircraft system failures prevent the aircraft from being able to land on the runway in those conditions |
| ON6 – WV alert 1) going to hit 2) actually hit | WV alert activated Windshear blows wake vortex into path | Incorrectly assign a light aircraft to follow a heavy Only ATC has the WV advisory -- and fails to notify the pilot | Pilot has a WV alert (display) but fails to notice Pilot does not read WV information from ATM Pilot sets wrong spacing Pilot fails to activate the WV alerting system | WV system gets incorrect data and fails to alert ATC / pilot WV model incorrectly predicts wake vortex |

Off Nominal Conditions: NextGen SDO Approach / Arrivals

| Contributing factors Off-nominal Occurrence | Environment (i.e., sudden turbulence or windshear) | Management Interaction with other humans (e.g., pilot-pilot or pilot-ATC) | Human Pilot Error | Machine Automation errors |
|--|--|---|--|---|
| ON7 – pop-up traffic on CDTI or disappearing traffic on CDTI | Too much noise (electronic noise) for ADS-B to show aircraft Rain obscures radar or ADSB visibility | Non-equipped aircraft appears in controlled airspace Pilot of other aircraft has shut off the transponder Pilot of other aircraft has the transponder set at the wrong power level ATM fails to slow down other aircraft that are traveling too fast (suddenly pop up) | Pilot sets the wrong altitude to see lead aircraft / surrounding traffic | ADS-B transponder failure TISB failure Transponder of other aircraft is out of order |
| ON8 – CSPA violation / break-off | Windshear Wake vortex | VCSPA blunder – one aircraft alters trajectory, forces decoupling, and breaks off | Pilot sets incorrect spacing | CSPA automation fails Airborne Information for Lateral Spacing fails |
| ON9 – no runway visible below DH | Runway not visible (fog) Environmental conditions (rain, fog) obscure EVS view | ? | Pilot fails to notice / detect runway due to other tasks Pilot has set DH incorrectly – altitude too high to see runway | Failure in the ground system (transmitter) Failure in the aircraft receiver Failure of altimeter system – actually above DH |
| ON10 – runway offset | Crosswind blows aircraft off track | ATM sent the incorrect runway via datalink and the aircraft is aligned to that runway | Pilot entered the wrong runway for landing Pilot set the wrong frequency Pilot read the incorrect approach plate | ILS or ADSB fails |

Off Nominal Conditions: NextGen SDO Approach / Arrivals

| Contributing factors Off-nominal Occurrence | Environment (i.e., sudden turbulence or windshear) | Management Interaction with other humans (e.g., pilot-pilot or pilot-ATC) | Human Pilot Error | Machine Automation errors |
|---|---|---|--|---|
| ON1 – runway incursion (on EVS or in OTW view) | Object on runway (e.g., baggage cart) | Aircraft on runway to be landed – cleared to land before the other aircraft has cleared the runway Other pilot fails to hold short / brake Other aircraft enters incorrect weight | Pilot fails to notice runway incursion | Problems with the aircraft tires or braking system EVO database is out of date |
| ON12 – overspeed on landing, overshoot exit or LAHS | Sudden tailwind pushes airspeed higher | ATM has pilot land on a runway that is too short ATM has pilot land on a down-sloping runway | Pilot enters incorrect target speed Pilot entered incorrect aircraft weight (aircraft heavier than expected) | TNASE out of date – incorrect taxiway information RAAS failure Brakes fail to work properly Airbrakes not deployed |
| ON13 – incursions on the ground | Environmental conditions (rain, fog) obscure EVS / MMWR view Wind blows an obstruction on the runway | ATM fails to update TNASE or NOTEMs regarding maintenance work ATM fails to notify the pilot about obstructions Another pilot fails to hold short / brake | Pilot fails to notice obstructions presented in TNASE, NOTEMs, SVS, Datalink Pilot has the ground vision system set incorrectly | TNASE out of date MMWR not working properly Datalink, NOTEMs not transmitted correctly |
| ON14 – Aircraft emergency (causes disturbances throughout the system) | Lightning strike | Terrorist | Medical emergency on board | Problem with e.g., windshield, landing gear, loss of fuel, loss of hydraulic fluid |

Off Nominal Conditions: NextGen SDO Departures

| Contributing factors Off-nominal Occurrence | Environment (i.e., sudden turbulence or windshear) | Management Interaction with other humans (e.g., pilot-pilot or pilot-ATC) | Human Pilot Error | Machine Automation errors |
|--|---|---|---|---|
| ON1a - Data entry error (FMS, EFB, datalink) | Sudden gust blows the aircraft | ATC types in an incorrect 4D departure path or an incorrect runway | Loads an incorrect departure path | Datalink error causes the wrong data to be transmitted |
| ON1b - Route into terrain | | ATC assigns a route without confirming | Pilot accepts a route without confirming | RNAV routes have not been verified. No mechanism exists to allow pilot / ATC to verify the routes |
| ON1b - Runway change during taxi | Weather – windshear - could cause the change in runway | ATC fails to inform the pilot of the change ATC informs, but provides incorrect information | Pilot fails to update FMS Pilot updates FMS with incorrect runway | FMS does not accept the new runway / trajectory |
| ON2 – Runway incursion leads to rejected takeoff | Object on runway | Aircraft on runway for takeoff – cleared to takeoff before the other aircraft has cleared the runway Another pilot fails to hold short / brake | Pilot fails to notice runway incursion | Equivalent visual operations database is out of date |
| ON3 – Incorrect Speed leads to rejected takeoff | Unexpected tail winds force the aircraft to miss the time window Poor traction on runway (too slick) | Lead aircraft fails to depart / climb at expected rate | Pilot fails to release brakes Pilot fails to enter correct speed Pilot fails to correctly monitor speed at V1 | Autothrust fails Engine failure Airspeed / thrust display errors Note: it is unclear what NextGen cockpit automation may support RTO decisions |

Off Nominal Conditions: NextGen SDO Departures

| Contributing factors ----- Off-nominal Occurrence | Environment (i.e., sudden turbulence or windshear) | Management Interaction with other humans (e.g., pilot-pilot or pilot-ATC) | Human Pilot Error | Machine Automation errors |
|---|--|---|---|---|
| ON4 – 4 DT miss | Head / tail winds force the aircraft to miss the time window. Temperature (too hot, making it difficult to climb) Icing or thunderstorms along the path WV forces aircraft off path | ATM issues an incorrect trajectory, times ATM requests airspeeds that are not achievable ATM issues a time that can not be achieved ATM issues a path through a thunderstorm / area of icing | Pilot enters an incorrect time or trajectory Pilot inputs an incorrect rate of climb | Auto thrust fails, making it impossible to meet required times Loss of aircraft control systems (e.g., flaps fail, making it impossible to make tight turns) Loss of an engine makes it impossible to meet times Aircraft too heavy; can not climb as required Air data computer failure Lose pilot RADEM, forced to fly by pitch and power A glitch between computers causes incorrect data transfer from air - ground |
| ON5 – RNP compliance alert 1) Pilot has the wrong path 2) Pilot is unable to fly the path | Weather conditions disrupt technology (e.g., misty fog and MMWR), resulting in degraded RNP | ATC fails to notice an aircraft has degraded RNP ATC notices an aircraft has degraded RNP, but fails to assign an appropriate new trajectory | Failure to monitor RNP (do not detect that actual performance is not acceptable) Programs an incorrect setpoint for the RNP alert Failure to notice RNP alert – continues without having adequate RNP | Degradation of navigation systems (e.g., GPS failure) FMS Failure Loss of aircraft control systems |

Off Nominal Conditions: NextGen SDO Departures

| Contributing factors ----- Off-nominal Occurrence | Environment (i.e., sudden turbulence or windshear) | Management Interaction with other humans (e.g., pilot-pilot or pilot-ATC) | Human Pilot Error | Machine Automation errors |
|---|---|---|--|--|
| ON6 – ATMs Upload new trajectory | Thunderstorm or icing conditions exist along the new path Insufficient time exists for a new path plan to be developed and implemented | ATC uploads an incorrect trajectory, incorrect times, or an incorrect departure runway The upload is not completed in a timely manner, causing the aircraft to encroach on other traffic | Pilot fails to accept the new trajectory Data entry error Failure to fly aircraft while interacting with ATC on the new trajectory Pilot does not notice that LNAV / heading select are in the wrong mode | Predictions of uncertainty requires automation Degradation of navigation systems prevent the new trajectory from being implemented Automation is not able to follow the new trajectory |
| ON7 – WV alert 1) predicted encounter 2) actual encounter | WV alert activated Windshift blows wake vortex into path | Incorrect computation of minimum spacing Only ATC has the WV advisory – and fails to notify the pilot | Pilot has a WV alert (display) but fails to notice Pilot does not read WV information from ATM Pilot sets wrong spacing Pilot fails to activate the WV alerting system | WV system gets incorrect data and fails to alert ATC / pilot WV model incorrectly predicts wake vortex |
| ON8 – pop up traffic on CDTI or disappearing traffic on CDTI | Too much noise (electronic noise) for ADS-B to show aircraft Rain obscures radar or ADSB visibility | Non-equipped aircraft appears in controlled airspace Pilot of other aircraft has shut off the transponder Pilot of other aircraft has the transponder set at the wrong power level ATM fails to slow down other aircraft that are traveling too fast (suddenly pop up) | Pilot sets the wrong altitude to see lead aircraft / surrounding traffic | ADS-B transponder failure TISB failure Transponder of other aircraft is out of order |

CHAPTER 10. APPENDIX E. PHASE 1 SUMMARY OF THE DEMOGRAPHIC DATA FROM THE PILOT FOCUS GROUP

| <i>Question</i> | <i>Pilot 1</i> | <i>Pilot 2</i> | <i>Pilot 3</i> | <i>Pilot 4</i> | <i>Pilot 5</i> | <i>Pilot 6</i> | <i>Code</i> |
|---------------------------------------|---|--|---|---|--|---|----------------------------------|
| Q1. Age | 60 | 47 | 46 | 43 | 39 | 50 | |
| Q2. Gender | 1 | 1 | 1 | 1 | 1 | 1 | 1 = male; 2 = female |
| Q3. Years as pilot | 33 | 29 | 30 | 21 | 14 | 31 | |
| Q4. Yrs since retirement | 0.75 | -- | -- | -- | -- | -- | |
| Q5. Crew position | 1 | 2 | 2 | 2 | 1 | 2 (747) | 1 = captain; 2= first officer |
| Q6. Commercial or cargo | 1 | 1 | 1 | 1 | 2 | 1 | 1 = Commercial; 2 = Cargo |
| Q8. Aircraft experience (type, hours) | P-3(L-188), 4000; DC-9/B-727, 8000; B-757/767, 2500; B-777, 1500; B-747, 4500 | 777, 2000; 737, 2000; 757/767, 2000; T-38, 3000 | B737, 2100; B747, 2100; P-3 ORION, 2300; B757/767, 500; B777, 120; Civil A/C, 500 | 737, 1200; DC9, 4000; C-141, 2000; T-38, 1500 | Various General Aviation, 2500; Jetstream 3201, 500; Canadair RJ, 500; B747-400, 200 | C-141, 4200; B-747, 6800; B-737, 2450; B-727, 850 | |
| Q9. Parallel Approach Experience | 1 | 1 | 1 | 1 | 0 | 1 | 1 = yes; 0 = no |
| Q9: Comment | SFO, many training exercises. MSP, PRM app in simulators. 2 actual SOIA into SFO- both to full stop | Yes, at SFO visual and PRM approaches to Rnwys 28L and 28R | Yes, as a SFO based pilot for 13 yrs; SFO rwys 28L/R | Yes, SFO, STL, PHL, in 737 and DC9 | | Trained on offset and SOIA | |

Appendix E – Demographics

| Question | Pilot 1 | Pilot 2 | Pilot 3 | Pilot 4 | Pilot 5 | Pilot 6 | Code |
|---|-------------------------------------|-------------------------------------|--|------------------------------------|-------------------------------------|-------------------------------------|------------------------------------|
| Q10. Tailored Arrivals / CDA experience | 1 | 1 | 1 | 0 | 1 | 1 | 1 = yes; 0 = no |
| Q10: Comment | Not reported to maintain anonymity. | Not reported to maintain anonymity. | Not reported to maintain anonymity. | Not reported to maintain anonymity | Not reported to maintain anonymity. | Not reported to maintain anonymity. | Not reported to maintain anonymity |
| Q11: Datalink | 1 | 1 | 1 | 1 | 1 | 1 | |
| Q11: FMS | 1 | 1 | 1 | 1 | 1 | 1 | 1 = yes; 0 = no |
| Q11: HUD | 0 | 0 | 1 (limited) | 1 | 0 | 0 | |
| Q11: SVS | 0 | 0 | 0 | 0 | 0 | 0 | |
| Q11: TD | 1 | 1 | 0 | 1 | 1 | 1 | |
| Q11: WD | 1 | 1 | 1 | 1 | 1 | 1 | |
| Q11: Others | 0 | 0 | Tactical displays used for anti-submarine warfare ops. Used to present the tactical picture to the pilots of a P-3 | 737 glass cockpit | 0 | 0 | |

CHAPTER 11. APPENDIX F. PHASE 1 SUMMARY OF INPUT FROM THE ATC SME

Notes from meeting with former ATC / Tracon controller
July 15, 2008

The following are the ATC SME's views on the expected changes in ATC in the next 20 years, and potential off nominals in NextGen (general, arrivals, and departures).

General comments on the direction of ATC / ATM

- **More automation** – automation will take over many of the tasks currently performed by ATC. This is necessary due to the increasing complexity (and thus workload) of increased capacity airspace. The ATCer's role will change to be a monitor, stepping in as needed.
- **New, enhanced technology** – devices such as 3D scopes (perhaps multiple 2D views, or 2D – rotate to convert to 3D) and touch screens will become more common.
- **Voice communication as a backup** – while datalink is expected to replace many ATC – pilot communications, it will be necessary to keep voice communication as a backup. Voice / verbal communications are much faster in more useful in emergency situations.
- **Continuous monitoring and updating** – the automation will monitor aircraft and their performance on the 4D trajectories. It will realize when aircraft will miss (or have just missed) a target, and quickly recalculate to provide updates on the planned path.
- **Contingency planning** – automation will calculate and “keep in mind” various contingency plans (“scenarios in the background”) in case of unexpected events or emergencies.
- **Stronger authority** – the “pilot should have no say” in accepting pairings or in which taxiway to take. These will be regarded as clearances rather than suggestions. Once the automation decides, the pilot simply complies.
- **Clearances to the gate** – clearances will not simply be issued for altitudes and landing. ATM will clear pilots to the gate. This includes taxiways and the final gate.
- **ATM-controlled spacing** – aircraft spacing will be controlled by automation. This will be determined by the ATC automation. Pilots will not be (solely) responsible for maintaining separation.
- **Airspace redesign** – the whole concept of airspace will need revisiting. It might very well be necessary to make radical changes in the way airspace is allocated (e.g., dynamically configurable airspace).

General issues regarding NextGen Off-Nominals

- **Weather** - Weather will have a tremendous impact on 4D trajectory planning, and will create the need for frequent updates and modified plans.
- **Automation** - Increased ATM automation will reduce the possibility of human error – Many of the issues we identified as ATC off nominals (e.g., regarding data entry errors) will not be a concern because they will be performed by automation.

- ***“Upload a new trajectory”*** – this is not a true off nominal, in the sense that 1) once an off-nominal has occurred, this is the correct thing to do 2) it is very likely that new trajectories will be reissued frequently in NextGen

Departure Off-Nominals

- Comment: Departing aircraft have different climbing performance characteristics (also vary with altitude and temperature) – the 4D trajectory planning software will need to take this into account

CHAPTER 12. APPENDIX G. PHASE 1 TABLE OF OFF-NOMINAL EVENTS AND CONTRIBUTING FACTORS

Off-nominal Occurrences and Contributing Factors in NextGen Arrival / Approach Scenarios

| <p>Contributing factors</p> <p>-----</p> <p>Off-nominal Occurrence</p> | <p><i>Environment</i> (i.e., sudden turbulence or windshear)</p> | <p><i>Management</i> <i>Interaction with other humans</i> (e.g., pilot-pilot or pilot-ATC)</p> | <p><i>Human</i> <i>Pilot Error</i></p> | <p><i>Machine</i> <i>Automation errors</i></p> |
|--|---|---|--|---|
| <p>ON1 – Data input error (FMS, EFB, Data link)</p> | <p><i>Turbulence (can lead to a data entry error / incorrect or inadvertent key press)</i></p> | <p><i>ATC types in an incorrect lead aircraft ID, an incorrect trajectory, incorrect times, or an incorrect runway</i></p> <p><i>FMS manufacturer, electronic maps, other database providers make a data entry error.</i></p> | <p><i>Select wrong aircraft ID from a list</i></p> <p><i>Enter incorrect flight path parameters</i></p> | <p><i>En Route Descent Advisor calculates the wrong path (incorrect winds, temperature)</i></p> <p><i>Locks onto an incorrect aircraft</i></p> <p><i>Incorrect information coded into the FMS database</i></p> |
| <p>ON2 – 4-DT miss</p> | <p><i>Head / tail winds force the aircraft to miss the time window.</i></p> <p><i>Icing or thunderstorms along the path</i></p> | <p><i>ATC tells the pilot to follow the wrong aircraft</i></p> <p><i>ATC requests airspeeds that are not achievable</i></p> <p><i>ATC issues a time that can not be achieved</i></p> <p><i>ATC issues a path through a thunderstorm / area of icing</i></p> | <p><i>Pilot enters an incorrect time or trajectory</i></p> <p><i>Pilot inputs incorrect descent parameters</i></p> | <p><i>Auto thrust fails, making it impossible to meet required times</i></p> <p><i>Loss of aircraft control systems (e.g., flaps fail, making it impossible to make tight turns)</i></p> <p><i>Loss of an engine makes it impossible to</i></p> |

| <p>Contributing factors</p> <p>-----</p> <p>Off-nominal Occurrence</p> | <p>Environment <i>(i.e., sudden turbulence or windshear)</i></p> | <p>Management <i>Interaction with other humans</i> <i>(e.g., pilot-pilot or pilot-ATC)</i></p> | <p>Human <i>Pilot Error</i></p> | <p>Machine <i>Automation errors</i></p> |
|--|---|---|---|--|
| | | <p><i>Aircraft has to slow down because preceding aircraft is going too slowly</i></p> | | <p><i>meet times</i> <i>Air data computer failure</i></p> <p><i>Lose pitot RADEM; forced to fly by pitch and power</i></p> <p><i>A glitch between computers causes incorrect data transfer</i></p> |
| <p>ON3 – RNP compliance alert (Out of compliance)</p> <p>1) Pilot has the wrong path</p> <p>2) Pilot is unable to fly the path</p> | <p><i>Weather conditions disrupt technology (e.g., misty fog and MMWR), resulting in degraded RNP</i></p> | | <p><i>Pilot programs an incorrect setpoint for the RNP alert</i></p> <p><i>Pilot enters an incorrect time or trajectory</i></p> | <p><i>Degradation of navigation systems (e.g., GPS failure)</i></p> <p><i>FMS Failure</i></p> <p><i>Degradation of aircraft control systems</i></p> |
| <p>ON4 – ATMs Upload new trajectory</p> | <p><i>Severe weather or icing conditions exist along the new path</i></p> | <p><i>ATC uploaded an incorrect original lead aircraft, an incorrect trajectory, incorrect times, or an incorrect runway</i></p> <p><i>The original negotiation</i></p> | <p><i>Pilot was unable to comply with previous trajectory constraints</i></p> | <p><i>Degradation of navigation systems prevented the original trajectory from being implemented</i></p> <p><i>Automation was not</i></p> |

| <p>Contributing factors</p> <p>-----</p> <p>Off-nominal Occurrence</p> | <p>Environment <i>(i.e., sudden turbulence or windshear)</i></p> | <p>Management <i>Interaction with other humans</i> <i>(e.g., pilot-pilot or pilot-ATC)</i></p> | <p>Human <i>Pilot Error</i></p> | <p>Machine <i>Automation errors</i></p> |
|--|--|--|--|--|
| | | <p><i>(NI) was not completed in a timely manner, so the planned TOD was missed, requiring revision</i></p> | | <p><i>able to follow the original trajectory</i></p> <p><i>Failure of controller’s automation on the original trajectory upload</i></p> |
| <p>ON5 – Runway change required</p> | <p><i>Crosswinds</i></p> <p><i>Tailwind >10 knots</i></p> <p><i>Thunderstorms, icing, rain/snow</i></p> <p><i>Fog</i></p> <p><i>Initially-planned runway out of service</i></p> <p><i>Disabled aircraft on the runway</i></p> | <p><i>Uplink the wrong path</i></p> <p><i>Select the wrong path</i></p> <p><i>ATC selects a runway that is not appropriate for the aircraft (too short, inappropriate surface for environment, taxiways too narrow)</i></p> <p><i>NOTEMS are not up-to-date</i></p> <p><i>(NOTE: All of these errors were made in ON1)</i></p> | <p><i>Pilot / crew not certified to land in the initial runway assignment conditions</i></p> | <p><i>Landing guidance is out of service</i></p> <p><i>Aircraft system failures prevent the aircraft from being able to land on the runway in those conditions</i></p> |
| <p>ON6 – Wake vortex alert</p> <p>1) alert corresponds to an actual problem</p> | <p><i>Wind shift blows wake vortex into path (1,3)</i></p> | <p><i>Incorrectly assign a light aircraft to follow a heavy (1)</i></p> <p><i>The lead aircraft deviates</i></p> | <p><i>Pilot sets wrong spacing (2 or 3)</i></p> | <p><i>WV model incorrectly predicts wake vortex (2,3)</i></p> |

| <p>Contributing factors</p> <p>-----</p> <p>Off-nominal Occurrence</p> | <p>Environment <i>(i.e., sudden turbulence or windshear)</i></p> | <p>Management <i>Interaction with other humans</i> <i>(e.g., pilot-pilot or pilot-ATC)</i></p> | <p>Human <i>Pilot Error</i></p> | <p>Machine <i>Automation errors</i></p> |
|--|---|---|--|---|
| <p>2) false alarm</p> <p>3) miss</p> | | <p><i>from the 4D trajectory (other pilot blunder) (1)</i></p> | <p><i>Pilot fails to activate the WV alerting system (3)</i></p> | <p><i>WV system gets incorrect data and incorrectly alerts ATC / pilot (2)</i></p> <p><i>WV system gets incorrect data and fails to alert ATC / pilot (3)</i></p> |
| <p>ON7 – Unexpected Traffic</p> | <p><i>Too much noise (electronic noise) for ADS-B to show aircraft</i></p> <p><i>Rain obscures radar or ADSB visibility</i></p> | <p><i>Non-equipped aircraft appears in controlled airspace</i></p> <p><i>Pilot of other aircraft has shut off the transponder</i></p> <p><i>Pilot of other aircraft has the transponder set at the wrong power level</i></p> <p><i>Another aircraft enters the CDTI range from below or above and first appears on ownship’s CDTI when it is close to the ownship</i></p> | <p><i>Pilot sets the wrong altitude to see lead aircraft / surrounding traffic</i></p> | <p><i>Surveillance Broadcast (e.g., ADS-B) failure</i></p> <p><i>TISB failure (serving non-transponder-equipped aircraft)</i></p> <p><i>Transponder of other aircraft is out of order</i></p> |
| <p>ON8 – CSPA violation / break-off</p> | <p><i>Wind shift</i></p> <p><i>Wake vortex</i></p> | <p><i>CSPA blunder – one aircraft alters trajectory, forces decoupling, and breaks off</i></p> | <p><i>Pilot sets incorrect spacing</i></p> | <p><i>CSPA automation fails</i></p> |

Appendix G – Off-Nominal Events

| <p>Contributing factors</p> <p>-----</p> <p>Off-nominal Occurrence</p> | <p>Environment <i>(i.e., sudden turbulence or windshear)</i></p> | <p>Management <i>Interaction with other humans</i> <i>(e.g., pilot-pilot or pilot-ATC)</i></p> | <p>Human <i>Pilot Error</i></p> | <p>Machine <i>Automation errors</i></p> |
|--|--|--|---|---|
| | <p><i>Unable to maintain sufficient separation due to flight dynamics</i></p> | <p><i>Unable to maintain miles, time separation</i></p> | | |
| <p>ON9 – no runway visible below DH</p> | <p><i>Runway not visible (fog)</i></p> <p><i>Environmental conditions (rain, fog) obscure EVS view</i></p> | | <p><i>Pilot fails to notice / detect runway due to other tasks</i></p> <p><i>Pilot has set DH incorrectly – altitude too high to see runway</i></p> | <p><i>Failure in the ground system (transmitter)</i></p> <p><i>Failure in the aircraft receiver</i></p> <p><i>Failure of altimeter system – actually above DH</i></p> <p><i>Failure of approach lighting system</i></p> |
| <p>ON10 – runway offset</p> | <p><i>Crosswind blows aircraft off track</i></p> | <p><i>ATM sent the incorrect runway via data link and the aircraft is aligned to that runway (see ON1)</i></p> | <p><i>Pilot entered the wrong runway for landing</i></p> <p><i>Pilot set the wrong frequency</i></p> | <p><i>Landing guidance or ADSB fails</i></p> |
| <p>ON11 – runway incursion (on EVS or in OTW view)</p> | <p><i>Object on runway (e.g., luggage cart)</i></p> | <p><i>Aircraft (on runway to be landed) has not left the runway in the expected time</i></p> <p><i>Other pilot fails to hold</i></p> | <p><i>Pilot continues approach out of compliance with clearance</i></p> | <p><i>Problems with the aircraft tires or braking system</i></p> <p><i>EVO sensors fail</i></p> |

| <p>Contributing factors</p> <p>-----</p> <p>Off-nominal Occurrence</p> | <p>Environment <i>(i.e., sudden turbulence or windshear)</i></p> | <p>Management <i>Interaction with other humans</i> <i>(e.g., pilot-pilot or pilot-ATC)</i></p> | <p>Human <i>Pilot Error</i></p> | <p>Machine <i>Automation errors</i></p> |
|--|---|---|---|---|
| | | <p><i>short / brake</i></p> | | <p><i>ASDX fails, so aircraft on the ground are not presented on displays</i></p> |
| <p>ON12 – overspeed on landing, overshoot exit or LAHS</p> | <p><i>Sudden tailwind pushes airspeed /groundspeed higher</i></p> <p><i>Slick runway (ice, water) reduces traction and increases braking distance</i></p> | <p><i>ATM has pilot land on a runway that is too short</i></p> | <p><i>Pilot enters incorrect target speed</i></p> <p><i>Pilot entered incorrect aircraft weight (aircraft heavier than expected)</i></p> <p><i>Pilot deliberately chooses another, more distant exit (to expedite taxi to the gate)</i></p> | <p><i>Surface Management Automation incorrect</i></p> <p><i>RAAS failure</i></p> <p><i>Airbrakes not deployed</i></p> |
| <p>ON13 – Incursions on the ground</p> | <p><i>Environmental conditions (rain, fog) obscure EVS / MMWR view</i></p> <p><i>Wind blows an obstruction on the runway</i></p> <p><i>Animal (e.g., deer) runs onto runway</i></p> | <p><i>ATM fails to update Surface Management Automation or NOTAMs regarding maintenance work</i></p> <p><i>ATM fails to notify the pilot about obstructions</i></p> <p><i>Another pilot fails to hold short / brake</i></p> | <p><i>Pilot fails to notice obstructions presented in Surface Management Automation, NOTAMs, SVS, Data link</i></p> <p><i>Pilot has the ground vision system set incorrectly</i></p> | <p><i>Surface Management Automation incorrect</i></p> <p><i>ASDX fails, so aircraft on the ground are not presented on displays</i></p> <p><i>Surface Management Automation out of date – incorrect taxiway information</i></p> |

Appendix G – Off-Nominal Events

| <i>Contributing factors</i> ----- <i>Off-nominal Occurrence</i> | <i>Environment</i> <i>(i.e., sudden turbulence or windshear)</i> | <i>Management</i> <i>Interaction with other humans</i> <i>(e.g., pilot-pilot or pilot-ATC)</i> | <i>Human</i> <i>Pilot Error</i> | <i>Machine</i> <i>Automation errors</i> |
|---|---|--|------------------------------------|--|
| | | | | <i>MMWR not working properly</i> <i>Data link, NOTAMs not transmitted correctly</i> |

Off-nominal Occurrences and Contributing Factors in NextGen Departure Scenarios

| <i>Contributing factors</i> ----- <i>Off-nominal Occurrence</i> | <i>Environment</i> <i>(i.e., sudden turbulence or windshear)</i> | <i>Management</i> <i>Interaction with other humans</i> <i>(e.g., pilot-pilot or pilot-ATC)</i> | <i>Human</i> <i>Pilot Error</i> | <i>Machine</i> <i>Automation errors</i> |
|---|---|--|------------------------------------|--|
| | | | | |

| <p><i>Contributing factors</i></p> <p>-----</p> <p><i>Off-nominal Occurrence</i></p> | <p><i>Environment (i.e., sudden turbulence or windshear)</i></p> | <p><i>Management Interaction with other humans (e.g., pilot-pilot or pilot-ATC)</i></p> | <p><i>Human Pilot Error</i></p> | <p><i>Machine Automation errors</i></p> |
|--|---|--|---|--|
| <p>ON1 – Data entry error (FMS, EFB, Datalink)</p> | | <p><i>ATC types in an incorrect 4D departure path or an incorrect runway</i></p> <p><i>ATC assigns a route without confirming</i></p> <p><i>Data entry error leads to erroneous database</i></p> | <p><i>Loads an incorrect departure path</i></p> <p><i>Pilot accepts a route without confirming</i></p> | <p><i>Datalink error causes the wrong data to be transmitted</i></p> <p><i>RNAV routes have not been verified</i></p> <p><i>No mechanism exists to allow pilot / ATC to verify the routes</i></p> <p><i>FMS database contains an error</i></p> |
| <p>ON2 – Runway Incursion</p> | <p><i>Object on runway</i></p> | <p><i>Aircraft on runway for takeoff – cleared to takeoff before the other aircraft has cleared the runway</i></p> <p><i>Another pilot fails to hold short / brake</i></p> | <p><i>Pilot fails to heed non-clearance for takeoff instructions</i></p> | <p><i>Equivalent visual operations sensors malfunction</i></p> |
| <p>ON3 – Speed Anomaly</p> | <p><i>Unexpected tail winds force the aircraft to miss V_1</i></p> <p><i>Poor traction on runway (too slick)</i></p> | <p><i>Lead aircraft fails to depart / climb at expected rate</i></p> | <p><i>Pilot fails to enter correct speed</i></p> <p><i>Pilot fails to correctly monitor speed at V_1</i></p> | <p><i>Autothrust fails</i></p> <p><i>Engine failure</i></p> <p><i>Airspeed / thrust display errors</i></p> <p><i>Note: it is unclear</i></p> |

| <p>Contributing factors</p> <p>-----</p> <p>Off-nominal Occurrence</p> | <p>Environment (i.e., sudden turbulence or windshear)</p> | <p>Management Interaction with other humans (e.g., pilot-pilot or pilot-ATC)</p> | <p>Human Pilot Error</p> | <p>Machine Automation errors</p> |
|--|---|--|--|---|
| | | | | <p>what NextGen cockpit automation may support Rejected Takeoff decisions</p> |
| <p>ON4 – 4-DT miss</p> | <p>Head / tail winds force the aircraft to miss the time window.</p> <p>Temperature (too hot, making it difficult to climb)</p> <p>Icing or thunderstorms along the path</p> <p>WV forces aircraft off path</p> | <p>ATM issues an incorrect trajectory, times</p> <p>ATM requests airspeeds that are not achievable</p> <p>ATM issues a time that can not be achieved</p> <p>ATM issues a path through a thunderstorm / area of icing</p> <p>Aircraft has to slow down because preceding aircraft is going too slowly</p> | <p>Pilot enters an incorrect time or trajectory</p> <p>Pilot inputs an incorrect rate of climb</p> | <p>Auto thrust fails, making it impossible to meet required times</p> <p>Loss of aircraft control systems (e.g., flaps fail, making it impossible to make tight turns)</p> <p>Loss of an engine makes it impossible to meet times</p> <p>Aircraft too heavy; can not climb as required</p> <p>Air data computer failure</p> <p>Lose pitot RADEM; forced to fly by pitch and power</p> |

| Contributing factors ----- Off-nominal Occurrence | Environment <i>(i.e., sudden turbulence or windshear)</i> | Management <i>Interaction with other humans</i> <i>(e.g., pilot-pilot or pilot-ATC)</i> | Human <i>Pilot Error</i> | Machine <i>Automation errors</i> |
|---|--|---|---|---|
| | | | | <i>A glitch between computers causes incorrect data transfer from air - ground</i> |
| ON5 – RNP compliance alert (Out of compliance) 1) Pilot has the wrong path 2) Pilot is unable to fly the path | <i>Weather conditions disrupt technology (e.g., misty fog and MMWR), resulting in degraded RNP</i> | | <i>Pilot programs an incorrect set point for the RNP alert</i> <i>Pilot enters an incorrect time or trajectory</i> | <i>Degradation of navigation systems (e.g., GPS failure)</i> <i>FMS Failure</i> <i>Loss of aircraft control systems</i> |
| ON6 – ATMs Upload new trajectory | <i>Thunderstorm or icing conditions exist along the new path</i> | <i>ATC uploaded an incorrect original lead aircraft, an incorrect trajectory, incorrect times, or an incorrect runway</i> <i>The upload was not completed in a timely manner, causing the aircraft to encroach on the lead aircraft / other airspace</i> | <i>Pilot was unable to comply with previous trajectory constraints</i> | <i>Degradation of navigation systems prevented the original trajectory from being implemented</i> <i>Automation was not able to follow the original trajectory</i> |
| ON7 – WV alert 1) alert corresponds | <i>Windshift blows wake vortex into path (1,3)</i> | <i>Incorrectly assign a light aircraft to follow a heavy (1)</i> | <i>Pilot sets wrong spacing (2 or 3)</i> | <i>WV model incorrectly predicts wake vortex (2,3)</i> |

| <p><i>Contributing factors</i></p> <p>-----</p> <p><i>Off-nominal Occurrence</i></p> | <p><i>Environment (i.e., sudden turbulence or windshear)</i></p> | <p><i>Management Interaction with other humans (e.g., pilot-pilot or pilot-ATC)</i></p> | <p><i>Human Pilot Error</i></p> | <p><i>Machine Automation errors</i></p> |
|--|---|---|--|---|
| <p>to an actual problem</p> <p>2) false alarm</p> <p>3) miss</p> | | <p><i>A preceding aircraft deviates from the 4D trajectory (other pilot blunder) (1)</i></p> | <p><i>Pilot fails to activate the WV alerting system (3)</i></p> | <p><i>WV system gets incorrect data and incorrectly alerts ATC / pilot (2)</i></p> <p><i>WV system gets incorrect data and fails to alert ATC / pilot (3)</i></p> |
| <p>ON8 – Unexpected Traffic</p> | <p><i>Too much noise (electronic noise) for ADS-B to show aircraft</i></p> <p><i>Rain / solar flares obscure radar or ADSB visibility</i></p> | <p><i>Non-equipped aircraft appears in controlled airspace</i></p> <p><i>Pilot of other aircraft has shut off the transponder</i></p> <p><i>Pilot of other aircraft has the transponder set at the wrong power level</i></p> <p><i>Another aircraft enters the CDTI range from below or above and first appears on the ownship’s CDTI when it is close to the ownship</i></p> | <p><i>Pilot sets the wrong altitude to see lead aircraft / surrounding traffic</i></p> | <p><i>Surveillance broadcast failure</i></p> <p><i>TISB failure</i></p> <p><i>Transponder of other aircraft is out of order</i></p> |

CHAPTER 13. APPENDIX H. PHASE 1 COMPREHENSIVE LIST OF OFF-NOMINAL EVENT RATINGS

Approach

A comprehensive list of off-nominals including those that were developed by the project team (ON 1-13), and those added after meetings with NASA researchers (ON 14), and those generated by the focus group pilots (ON 15 – 19). It should be noted that off-nominals 14 - 19 were not evaluated in more detail as they were not unique to NextGen operations. However, they were identified and evaluated by the focus group pilots, so they are included here for completeness.

Perceived Safety Impact for Off-Nominals in NextGen Arrivals / Approaches

| <i>Off nominal event</i> | <i>Perceived Safety Impact*</i> | | | | | | <i>Average</i> | |
|---|---------------------------------|---|---|---|---|---|----------------|-----|
| | <i>Participant</i> | 1 | 2 | 3 | 4 | 5 | | 6 |
| ON1: FMS data entry error | | 5 | 6 | 2 | 7 | 3 | 3 | 4.3 |
| ON2: 4D Trajectory miss | | 3 | 4 | 2 | 4 | 4 | 4 | 3.5 |
| ON3: Required Navigation Performance compliance alert | | 2 | 3 | 5 | 2 | 3 | 3 | 3.0 |
| ON4: ATC uplinks a new trajectory | | 2 | 2 | 3 | 3 | 3 | 3 | 2.7 |
| ON5: Required runway change | | 2 | 2 | 2 | 4 | 3 | 4 | 2.8 |
| ON6: Wake Vortex alert | | 5 | 4 | 6 | 4 | 6 | 5 | 5.0 |
| ON7: Traffic alert | | 5 | 5 | 6 | 5 | 6 | 5 | 5.3 |
| ON8: Closely spaced parallel approach violation | | 6 | 6 | 7 | 6 | 6 | 6 | 6.2 |
| ON9: Runway not visible below minimum | | 3 | 4 | 3 | 5 | 5 | 6 | 4.3 |
| ON10: Runway offset | | 5 | 4 | 7 | 6 | 2 | 7 | 5.2 |
| ON11: Runway incursion | | 6 | 7 | 7 | 7 | 6 | 6 | 6.5 |
| ON12: Overspeed at landing / overshoot exit | | 4 | 4 | 3 | 2 | 3 | 5 | 3.5 |
| ON13: Runway incursion during taxi | | 6 | 4 | 7 | 6 | 6 | 6 | 5.8 |
| ON14: Aircraft emergency (priority) | | 6 | 5 | 7 | 4 | 5 | 7 | 5.7 |
| ON15: Pilot rejects clearance | | 2 | 3 | 1 | 1 | 2 | 3 | 2.0 |
| ON16: Missed displayed event | | 6 | 4 | 4 | 5 | 5 | 5 | 4.8 |
| ON17: Database Error | | 5 | 4 | 6 | 7 | 5 | 6 | 5.5 |
| ON18: Missed Approach | | 5 | 2 | 4 | 5 | 3 | 6 | 4.2 |
| ON19: Destabilized profile | | 6 | 4 | 7 | 5 | 5 | 4 | 5.2 |

*7-point rating scale, with 1 being the least severe and 7 being most severe.

Perceived Efficiency Impact for Off-Nominals in NextGen Arrivals / Approaches

| Off nominal event | Perceived Efficiency Impact* | | | | | | Average |
|---|-------------------------------------|---|---|---|---|---|----------------|
| | <i>Participant</i> | 1 | 2 | 3 | 4 | 5 | |
| ON1: Data entry error | 5 | 4 | 2 | 2 | 5 | 5 | 3.8 |
| ON2: 4D Trajectory miss | 3 | 5 | 4 | 2 | 6 | 5 | 4.2 |
| ON3: Required Navigation Performance compliance alert | 4 | 5 | 4 | 2 | 4 | 4 | 3.8 |
| ON4: ATC uplinks a new trajectory | 2 | 3 | 5 | 3 | 5 | 4 | 3.7 |
| ON5: Required runway change | 4 | 5 | 7 | 7 | 5 | 5 | 5.5 |
| ON6: Wake Vortex alert | 4 | 4 | 5 | 4 | 4 | 3 | 4.0 |
| ON7: Traffic alert | 2 | 3 | 5 | 3 | 5 | 2 | 3.3 |
| ON8: Closely spaced parallel approach violation | 3 | 6 | 4 | 4 | 4 | 2 | 3.8 |
| ON9: Runway not visible below minimum | 3 | 6 | 6 | 4 | 4 | 2 | 4.2 |
| ON10: Runway offset | 4 | 3 | 4 | 4 | 3 | 2 | 3.3 |
| ON11: Runway incursion | 5 | 7 | 5 | 4 | 5 | 2 | 4.7 |
| ON12: Overspeed at landing / overshoot exit | 5 | 4 | 5 | 3 | 4 | 2 | 3.8 |
| ON13: Runway incursion during taxi | 3 | 3 | 5 | 2 | 5 | 2 | 3.3 |
| ON14: Aircraft emergency (priority) | 5 | 5 | 5 | 4 | 5 | 7 | 5.2 |
| ON15: Pilot rejects clearance | 5 | 3 | 3 | 4 | 5 | 6 | 4.3 |
| ON16: Missed displayed event | 4 | 4 | 5 | 3 | 5 | 5 | 4.3 |
| ON17: Database Error | 6 | 4 | 6 | 6 | 5 | 4 | 5.2 |
| ON18: Missed Approach | 5 | 4 | 6 | 3 | 3 | 5 | 4.3 |
| ON19: Destabilized profile | 5 | 4 | 6 | 3 | 4 | 6 | 4.7 |

*7-point rating scale, with 1 being the least severe and 7 being most severe.

Departure

Below is a comprehensive list of the departure off-nominal events including those that were developed by the project team (ON 1,2,3,4,5,6,7,8). Those added after meetings with NASA researchers (ON 1b, 1c), and those generated by the focus group pilots (ON 9 - 15) were excluded from the document as they were either repetitive or not NextGen specific. Pilots estimated the impact of these off nominal occurrences on safety and on efficiency in NextGen so they are presented here for completeness.

Table 6: Perceived Safety Impact for Off-Nominals in NextGen Departures

| <i>Off nominal event</i> | <i>Perceived Safety Impact*</i> | | | | | | <i>Average</i> | |
|--|---------------------------------|----------|----------|----------|----------|----------|----------------|----------|
| | <i>Participant</i> | <i>1</i> | <i>2</i> | <i>3</i> | <i>4</i> | <i>5</i> | | <i>6</i> |
| ON1a: Data entry error | | 7 | 6 | 3 | 7 | 4 | 6 | 5.5 |
| ON1b: Runway change | | 6 | 3 | 1 | 3 | 2 | 6 | 3.5 |
| ON1c: Route into terrain | | 6 | 7 | 7 | 7 | 6 | 7 | 6.7 |
| ON2: Runway incursion | | 5 | 5 | 6 | 7 | 5 | 6 | 5.7 |
| ON3: Speed anomaly | | 4 | 5 | 6 | 5 | 5 | 6 | 5.2 |
| ON4: 4DT miss | | 2 | 4 | 3 | 4 | 2 | 5 | 3.3 |
| ON5: RNP compliance alert | | 3 | 3 | 5 | 2 | 4 | 4 | 3.5 |
| ON6: ATM uploads a new trajectory | | 2 | 3 | 2 | 2 | 3 | 3 | 2.5 |
| ON7: Wake vortex alert | | 5 | 4 | 6 | 5 | 5 | 6 | 5.2 |
| ON8: Unexpected traffic | | 6 | 5 | 6 | 5 | 5 | 6 | 5.5 |
| ON9: Delays for departure | | 3 | 1 | 4 | 2 | 2 | 2 | 2.3 |
| ON10: Intersection takeoff | | 2 | 3 | 2 | 2 | 1 | 5 | 2.5 |
| ON11: Other traffic on route | | 2 | 2 | 1 | 5 | 3 | 3 | 2.7 |
| ON12: Return to field | | 5 | 2 | 5 | 5 | 6 | 6 | 4.8 |
| ON13: Aircraft time on runway | | 2 | 2 | 3 | 3 | 4 | 5 | 3.2 |
| ON14: Departing aircraft can't make slot | | 3 | 1 | 4 | 1 | 2 | 3 | 2.3 |
| ON15: Change of taxiway clearance | | 4 | 3 | 1 | 3 | 2 | 3 | 2.7 |

*7-point rating scale, with 1 being the least severe and 7 being most severe.

Perceived Efficiency Impact for Off-Nominals in NextGen Departures

| Off nominal event | Perceived Efficiency Impact* | | | | | | Average |
|--|-------------------------------------|---|---|---|---|---|----------------|
| | <i>Participant</i> | 1 | 2 | 3 | 4 | 5 | |
| ON1a: Data entry error | 5 | 4 | 2 | 5 | 4 | 3 | 3.8 |
| ON1b: Runway change | 5 | 4 | 4 | 6 | 6 | 5 | 5.0 |
| ON1c: Route into terrain | 4 | 7 | 6 | 3 | 4 | 3 | 4.5 |
| ON2: Runway incursion | 4 | 7 | 6 | 3 | 5 | 6 | 5.2 |
| ON3: Speed anomaly | 4 | 7 | 3 | 2 | 5 | 4 | 4.2 |
| ON4: 4DT miss | 3 | 4 | 5 | 3 | 5 | 6 | 4.3 |
| ON5: RNP Compliance alert | 3 | 4 | 4 | 5 | 4 | 6 | 4.3 |
| ON6: ATM uploads a new trajectory | 2 | 4 | 3 | 3 | 4 | 6 | 3.7 |
| ON7: Wake Vortex alert | 3 | 4 | 3 | 1 | 5 | 3 | 3.2 |
| ON8: Unexpected traffic | 3 | 4 | 4 | 3 | 4 | 3 | 3.5 |
| ON9: Delays for departure | 5 | 6 | 5 | 6 | 5 | 6 | 5.5 |
| ON10: Intersection takeoff | 4 | 3 | 1 | 2 | 4 | 6 | 3.3 |
| ON11: Other traffic on route | 5 | 6 | 4 | 2 | 5 | 6 | 4.7 |
| ON12: Return to field | 6 | 7 | 5 | 6 | 5 | 6 | 5.8 |
| ON13: Aircraft time on runway | 5 | 5 | 5 | 4 | 5 | 4 | 4.7 |
| ON14: Departing aircraft can't make slot | 5 | 1 | 5 | 3 | 5 | 6 | 4.2 |
| ON15: Change of taxiway clearance | 4 | 3 | 4 | 3 | 4 | 6 | 4.0 |

*7-point rating scale, with 1 being the least severe and 7 being most severe.

CHAPTER 14. APPENDIX I. PHASE 2 LIST OF ALL OFF-NOMINAL STUDIES IDENTIFIED

- Abbott, T. S., & Elliott, D. M. (2001). A simulator experiment of the airborne information for lateral spacing system. *Proceedings of the 11th International Symposium on Aviation Psychology*. Columbus, OH. March, 2001.
- Alexander, A. L., & Wickens, C. D. (2005). *3D navigation and integrated hazard display in advanced avionics: Performance, situation awareness, and workload* (Technical Report AHFD-05-10/NASA-05-2). Savoy, IL: Aviation Human Factors Division.
- Alexander, A. L., & Wickens, C. D. (2006). Integrated hazard displays: Individual differences in visual scanning and pilot performance. *Proceedings of the Human Factors and Ergonomics Society 50th Annual Meeting*, 8-85.
- Alexander, A. L., Wickens, C. D., & Hardy, T. J. (2005). Synthetic vision and the primary flight display. *Human Factors*, 47, 693-707.
- Arthur, J. J., Prinzel, L. J., Bailey, R. E., Shelton, K. J., Williams, S. P., Kramer, L. J., & Norman, R. M. (2008). *Head-worn display concepts for surface operations for commercial aircraft* (NASA/TP-2008-215321). Hampton, VA: NASA.
- Arthur, J. J., Prinzel, L. J., Kramer, L. J., Parish, R. V., & Bailey, R. E. (2004). *Flight simulator evaluation of synthetic vision display concepts to prevent controlled flight in to terrain (CFIT)* (NASA/TP-2004-213008). Hampton, VA: NASA.
- Arthur, J. J., Prinzel, L. J., Williams, S. P., & Kramer, L. J. (2004). *Synthetic vision enhanced surface operations and flight procedures rehearsal tools* (NASA/TP-2004-213008). Hampton, VA: NASA.
- Azuma, R., Fox, J., & Furmanski, C. (2005). Evaluating visualization modes for closely-spaced parallel approaches. *Proceedings of the Human Factors and Ergonomics Society 49th Annual Meeting*, 35-39.
- Bailey, R. E., Kramer, L. J., & Prinzel, L. J. (2006). Crew and display concepts evaluation for synthetic enhanced vision systems. *Proceedings of SPIE, Vol. 6226*.
- Begault, D. (1993). Head-up auditory displays for traffic collision avoidance system advisories: A preliminary investigation. *The Journal of Human Factors*, 35(4), 707-717.
- Begault, D., & Pittman, M. T. (1995). 3-D audio versus head down TCAS displays. *Proceedings of the 8th International Symposium on Aviation Psychology, 1*, 116-121.

- Beringer, D. B., & Ball, J. D. (2001). General aviation visual performance using conformal and non-conformal head-up and head-down Highway-in-the-Sky displays. *Proceedings of the 11th International Symposium on Aviation Psychology*. Columbus, OH: Ohio State University.
- Beringer, D. B., & Ball, J. D. (2001). When gauges fail and clouds are tall, we miss the horizon most of all: General aviation pilot responses to the loss of attitude information in IMC. *Proceedings of the Human Factors and Ergonomics Society 45th Annual Meeting*, 21-25.
- Beringer, D. B., & Harris, H. C. (1999). Automation in general aviation: Two studies of pilot responses to autopilot malfunctions. *The International Journal of Aviation Psychology*, 9(2), 155-174.
- Bliss, J., & Capobianco, G. (2003). Mistrust of multiple alarm systems. *Proceedings of the 12th International Symposium on Aviation Psychology*. Dayton, OH: Ohio State University.
- Brou, R. J., Doane, S. M., Carruth, D. W., & Bradshaw, G. L. (2007). Pilot expertise and instrument failure: Detecting failure is only half the battle. *Proceedings of the Human Factors and Ergonomics Society 51st Annual Meeting*, 1306-1310.
- Coffey, E., Herdman, C., Brown, M., & Wade, J. (2007). Age-related changes in detecting unexpected air traffic and instrument malfunctions. *14th International Symposium on Aviation Psychology*, Wright State University. Dayton, Ohio. April 27-30, 2009.
- Dixon, S. R., Wickens, C. D., & McCarley, J. S. (2006). How do automation false alarms and misses affect operator compliance and reliance? *Proceedings of the Human Factors and Ergonomics Society 51st Annual Meeting*, 25-29.
- Earing, R. M. (1978). *The effects of expectancy and training on adaptation and detection of abrupt transition in control order*. Unpublished master's thesis, University of Illinois at Urbana-Champaign, Illinois.
- Fadden, S., Ververs, P. M., & Wickens, C. D. (2001). Pathway HUDS: Are they viable? *Human Factors*, 43, 173-193. (Study 2)
- Fischer, E., Haines, R. F., & Price, T. (1980). *Cognitive issues in Head-up Displays* (NASA TP-1711). Washington, DC: NASA.
- Flohr, E., & Huisman, H. (1997). Perspective flight displays in the 4D ATM environment. *Proceedings of the Ninth International Symposium on Aviation Psychology*, 2, 1087-1088.
- Foyle, D. C., Hooey, B. L., Wilson, J. R., & Johnson, W. A. (2002). HUD symbology for Surface operations: Command Guidance vs. Situation Guidance Formats. *SAE Transactions: Journal of Aerospace*, 111, 647-658.

- Helleberg, J. (2005). *Effects of a final approach runway occupancy signal (FAROS) on pilots' flight path tracking, traffic detection, and air traffic control communications*. McLean, VA: The MITRE Corporation.
- Hofer, E. F., Braune, R. J., Boucek, G. P., & Pfaff, T. A. (2001). *Attention switching between near and far domains: An exploratory study of pilots' attention switching with head-up and head-down tactical displays in simulated flight displays (D6-36668)*. The Boeing Company, October 18, 2001.
- Hooey, B. L., Foyle, D. C., & Andre, A. D. (2000). Integration of cockpit displays for surface operations: The final stage of a human-centered design approach. *SAE Transactions: Journal of Aerospace*, 109, 1053-1065.
- Hooey, B. H., Foyle, D. C., Andre, A. D., & Parke, B. (2000). Integrating Datalink and cockpit display technologies into current and future taxi operations. *Proceedings of the 19th Digital Avionics Systems Conference*, 2, 7D2/1 - 7D2/8.
- Iani, C., & Wickens, C. D. (2007). Factors affecting task management in aviation. *Human Factors*, 49, 16-24.
- Johnson, N. R., Wiegmann, D. A., & Wickens, C. D. (2005). *Effects of advanced cockpit displays on general aviation pilots' decisions to continue visual flight rules (VFR) flight into instrument meteorological conditions (IMC) (AFHD-05-18/NASA-05-6)*. Savoy, IL: University of Illinois, Aviation Human Factors Division.
- Jones, D. R. (2002). Runway incursion prevention system simulation evaluation. *Proceedings of the 21st Digital Avionics Systems Conference*, 2, 11B4-1- 11B4-12.
- Jones, D. R., & Prinzel L. J. (2006). *Runway incursion prevention for general aviation operations*. Paper presented at the 25th Digital Avionics Systems Conference, Portland, Oregon.
- Joseph, K. M., & Uhlarik, J. (1997). Using the competence-performance distinction to identify and assess situation awareness in a simulated IFR environment. *Proceedings of the Ninth International Symposium on Aviation Psychology*, 2, 1429-1435.
- Kalambi, V. V., Pritchett, A. R., Bruneau, D. P. J., Endsley, M. R., & Kaber, D. B. (2007). In-flight planning and intelligent pilot aids for emergencies and non-nominal flight conditions using automatically generated flight plans. *Proceedings of the Human Factors and Ergonomics Society 51st Annual Meeting*, 55-59.
- Kochan, J. A., Breiter, E. G., & Jentsch, F. (2004). Surprise and unexpectedness in flying: Database reviews and analyses. *Proceedings of the Human Factors and Ergonomics Society 48th Annual Meeting*, 335-339.

- Krems, M. H., & Severin, K. (1995). Collaborative problem solving in the cockpit: Crew communication and strategic decision making. *Proceedings of the 8th International Symposium on Aviation Psychology, 1*, 706-711.
- Latorella, K. A. (1998). Effects of modality on interrupted flight deck performance: Implications for datalink. *Proceedings of the Human Factors and Ergonomics Society 42nd Annual Meeting*, 87-91.
- Lorenz, B., & Biella, M. (2006). Evaluation of onboard taxi guidance support on pilot performance in airport surface navigation. *Proceedings of the Human Factors and Ergonomics Society 50th Annual Meeting*, 111-115.
- McCandless, J. W., McCann, R. S., Berumen, K. W., Gauvain, S. S., Palmer, V. J., Stahl, W. D., & Hamilton, A. S. (2005). Evaluation of the space shuttle cockpit avionics upgrade (CAU) displays. *Proceedings of the Human Factors and Ergonomics Society 49th Annual Meeting*, 10-14.
- McCann, R. S. & Jones, K. M. (2001). Depicting wire hazards on moving map displays: A test of two formats. *Proceedings of the 11th International Symposium on Aviation Psychology, Columbus, OH., March, 2001*.
- Metzger, U., & Parasuraman, R. (2001). Conflict detection aids for air traffic controllers in free flight: Effects of reliable and failure modes on performance and eye movements. *Proceedings of the 11th International Symposium on Aviation Psychology, Columbus, OH., March, 2001*.
- Moertl, P. M., Niehus, G., McGarry, K., Racine, N. S., Parasuraman, R., & Rehmann, A. (2004). Supporting taxiing for general aviation pilots through dynamic message signs: Simulation evaluation and implications for the prevention of runway incursions. *Proceedings of the Human Factors and Ergonomics Society 48th Annual Meeting*, 56-60.
- Mosier, K. L., & Palmer, E. A., & Degani, A. (1992). Electronic checklists: Implications for decision making. *Proceedings of the Human Factors Society 36th Annual Meeting, 1*, 7-11.
- Mosier, K. L., Skitka, L. J., Dunbar, M., & McDonnell, L. (2001). Aircrews and automation bias: The advantages of teamwork? *International Journal of Aviation Psychology, 11*(1), 1-14.
- Mosier, K. L., Skitka, L. J., Heers, S., & Burdick, M. (1998). Automation bias: Decision making and performance in high-tech cockpits. *The International Journal of Aviation Psychology, 8*(1), 47-63.
- Mumaw, R. J., Nikolic, M. I., Sarter, N. B., & Wickens, C. D. (2001). A simulator study of pilots' monitoring strategies and performance on modern glass cockpit aircraft. *Proceedings of the Human Factors and Ergonomics Society 45th Annual Meeting*, 73-77.

- Mumaw, R. J., Sarter, N. B., & Wickens, C. D. (2001). Analysis of pilots' monitoring and performance on an automated flight deck. *Proceedings of the 11th International Symposium on Aviation Psychology, Columbus, OH., March, 2001.*
- Murdoch, J. L., Ramsical, E. R., McNabb, J. L., & Bussing, F. J. (2005). *Flight experiment investigation of general aviation self-separation and sequencing tasks* (NASA/TP-2005-213539). Hampton, Virginia: NASA.
- Muthard, E. K., & Wickens, C. D. (2002). *Factors that mediate flight plan monitoring and errors in plan revision: An examination of planning under automated conditions* (AHFD-02-11/NASA-02-8). Savoy, IL: University of Illinois, Aviation Human Factors Division.
- Nadimian, R. M., & Burns, C. M. (2004). A visual display of flight time and distance. *Proceedings of the Human Factors and Ergonomics Society 48th Annual Meeting*, 6-10.
- Naish, J. M. (1964). Combination of information in superimposed visual fields. *Nature*, 202, 641-646.
- Newman, R. L. (1977). CH-3E (MARS) Head-Up Display Evaluation. *Crew Systems*, TR-77-2, 1977.
- Newman, R. L., McKay, D. E., Guirguis, M., & Zhang, R. (2002). Use of enhanced vision sensors for approach hazard detection. In *Proceedings of the NATO RTO SCI and SET Symposium on Enhanced and Synthetic Vision Systems*, September 10-12, 2002, Ottawa, Canada.
- Newman, R., & Foyle, D. C. (2003). Test scenarios for rare events. *Proceedings of the 12th International Symposium on Aviation Psychology*, 873-882.
- Olson, W. A., & Sarter, N. B. (1999). Informed consent in distributed cognitive systems: The role of conflict type, time pressure, and trust. *Proceedings of the 18th Digital Avionics Systems Conference, 1*, 4.B.1-1-4.B.1-6.
- Oving, A. B., Veltman, J. A., & Bronkhorst, A. W. (2004). Effectiveness of 3-D audio for warnings in the cockpit. *The International Journal of Aviation Psychology*, 14(3), 257-276.
- Prinzel, L. J., Hughes, M. F., Arthur, J. J., Kramer, L. J., Glaab, L. J., Bailey, R. E., Parrish, R. V., & Uenking, M. D. (2003). Synthetic vision CFIT experiments for GA and commercial aircraft: A picture is worth a thousand lives. *Proceedings of the Human Factors and Ergonomics Society 47th Annual Meeting*, 164-168.
- Prinzel, L. J., & Jones, D. R. (2007). Cockpit technology for the prevention of general aviation runway incursions. *Proceedings of the 14th International Symposium on Aviation Psychology, Dayton, OH., April 23-26.*
- Prinzel, L. J., Kramer, L. J., Arthur, J. J., Bailey, R. E., & Comstock, R. J. Jr. (2004). Comparison of head-up and head-down "Highway in the Sky" tunnel and guidance concepts for synthetic

vision displays. *Proceedings of the Human Factors and Ergonomics Society 48th Annual Meeting*, 11-15.

Prinzel, L. J., Kramer, L. J., & Bailey, R. (2007). *Going below minimums: The efficacy of display enhanced/synthetic vision fusion for go-around decisions during non-normal operations* (NASA/TP 20070018289). Hampton, VA: NASA.

Prinzel, L. J., Kramer, L. J., Bailey, R. E., & Sweeters, J. L. (2005). Development and evaluation of 2-D and 3-D exocentric synthetic vision navigation display concepts for commercial aircraft. *Proceedings of SPIE*, 5802(207).

Pritchett, A. R. (2000). Display effects on shaping apparent strategy: A case study in collision detection and avoidance. *The International Journal of Aviation Psychology*, 10(1), 59-83.

Pritchett, A. R., & Hansman, R. J. (1997). Experimental studies of pilot performance at collision avoidance during closely spaced parallel approaches. *Proceedings of the 9th International Symposium on Aviation Psychology*, 2, 1087-1088.

Riley, V., & Lyall, E. (1995). Pilot use of automation. *Proceedings of the 8th International Symposium on Aviation Psychology*, 1, 259-264.

Ross, R. E. (1976). Head-Up Display Evaluation. 6594th Test Group LTR-76-8.

Schroeder, B., & Sarter, N. (2001). Supporting decision-making and action selection under time pressure and uncertainty: The case of inflight icing. *Proceedings of the 11th International Symposium on Aviation Psychology*, Columbus, OH., March, 2001.

Schutte, P. C., & Trujillo, A. C. (1996). *Flight crew task management in non-normal situations* (20040110404). Hampton, Virginia: NASA.

Skitka, L. J., Mosier, K. L., Burdick, M., & Rosenblatt, B. (2000). Automation bias and errors: Are crews better than individuals? *The International Journal of Aviation Psychology*, 10(1), 85-96.

Smith, H. P. R. (1979). *A simulator study of the interaction of pilot workload with errors, vigilance, and decisions* (Technical Memorandum 78482). Moffett Field, CA: NASA.

Smith, J. D., Ellis, S. R., & Lee, E. C. (1984). Perceived threat and avoidance maneuvers in response to cockpit traffic displays. *The Journal of Human Factors*, 26(1), 33-48.

Stevens, S. M., Goldsmith, T. E., & Johnson, P. J. (2007). Performance differences on rejected takeoffs as a function of expectancy. *Proceedings of the Human Factors and Ergonomics Society 51st Annual Meeting*, 80-84.

- Stevens, S. M., Goldsmith, T. E., Johnson, P. D., & Moulton, J. B. (2007). *Skill decay on takeoffs as a result of varying degrees of expectancy*. Presented at the 14th International Symposium on Aviation Psychology, Dayton, OH.
- Stokes, A. F., Downs, J. L., Pharmer, J. A., & Bohan, M. (1997). Evaluation of pilot performance using conventional electromechanical and electronic aircraft engine monitoring displays. *Proceedings of the 9th International Symposium on Aviation Psychology*, 2, 1089-1093.
- Thomas, L. C., & Wickens, C. D. (2004). Eye-tracking and individual differences in off-normal event detection when flying with a synthetic vision system display. *Proceedings of the Human Factors and Ergonomics Society 48th Annual Meeting*, 223-227.
- van Westrenen, F., & Groeneweg, J. (2003). Co-operative conflict resolution: An experimental validation of aircraft self-separation in a classroom environment. *The International Journal of Aviation Psychology*, 13(3), 233-248.
- Ververs, P. M., Dorneich, M. C., Good, M. D., & Downs, J. L. (2002). Integrating critical information on flight deck displays. *Proceedings of the Human Factors and Ergonomics Society 46th Annual Meeting*, 11-15.
- Weintraub, D. J., Haines, R. F., & Randle, R., (1985). Head-up Display (HUD) utility, II: Runway to HUD transitions monitoring eye focus and decision times. *Proceedings of the 29th Annual Meeting of the Human Factors and Ergonomics Society*, 616-619.
- Wickens, C. D., Alexander, A. L., Horrey, W. J., Nunes, A., Hardy, T. J., & Zheng, X. S. (2004). Traffic and flight guidance depiction on a synthetic vision system display: The effects of clutter on performance and visual attention allocation. *Proceedings of the Human Factors and Ergonomics Society 48th Annual Meeting*, 218-222.
- Wickens, C., Dixon, S., Goh, J., & Hammer, B. (2005). Pilot dependence on imperfect diagnostic automation in simulated UAV flights: An attention visual scanning analysis. *Proceedings of the 13th International Symposium on Aviation Psychology*, 827-832.
- Wickens, C. D., Helleberg, J., & Xu, X. (2002). Pilot maneuver choice and workload in free flight. *Human Factors*, 44(2), 171-188.
- Wiegmann, D. A., Goh, J., & O'Hare, D. (2002). The role of situation assessment and flight experience in pilots' decision to continue visual flight rules flight into adverse weather. *The Journal of the Human Factors and Ergonomic Society*, 44(2), 189-197.
- Wiggins, M., & O'hare, D. (2003). Weatherwise: Evaluation of a cue-based training approach for the recognition of deteriorating weather conditions during flight. *Journal of the Human Factors and Ergonomic Society*, 45(2), 337-345.
- Williams, K. W. (2001). *Impact of aviation Highway-in-the-Sky displays on pilot situation awareness* (NTIS No. DOT/FAA/AM/-00/31). Oklahoma: Federal Aviation Administration.

**CHAPTER 15. APPENDIX J. PHASE 2 CODED LIST OF OFF-NOMINAL STUDIES
USED IN ANALYSES**

| New code | Original code | Reference |
|-------------|------------------|---|
| 1 | SVS5 | Alexander, A. L., & Wickens, C. D. (2005). <i>3D navigation and integrated hazard display in advanced avionics: Performance, situation awareness, and workload</i> (Technical Report AHFD-05-10/NASA-05-2). Savoy, IL: Aviation Human Factors Division. |
| 2 | SVS6 | Alexander, A. L., & Wickens, C. D. (2005). <i>3D navigation and integrated hazard display in advanced avionics: Performance, situation awareness, and workload</i> (Technical Report AHFD-05-10/NASA-05-2). Savoy, IL: Aviation Human Factors Division. (Study 3) |
| 3 | SVS1 | Alexander, A. L., Wickens, C. D., & Hardy, T. J. (2005). Synthetic vision and the primary flight display. <i>Human Factors</i> , 47, 693-707. (Study 1) |
| 4 | SVS2 | Alexander, A. L., Wickens, C. D., & Hardy, T. J. (2005). Synthetic vision and the primary flight display. <i>Human Factors</i> , 47, 693-707. (Study 2) |
| 5 | ES26a | Arthur, J. J., Prinzel, L. J., Kramer, L. J., Parish, R. V., & Bailey, R. E. (2004). <i>Flight simulator evaluation of synthetic vision display concepts to prevent controlled flight in to terrain (CFIT)</i> (NASA/TP-2004-213008). Hampton, VA: NASA. |
| 6 | ES23a | Arthur, J. J., Prinzel, L. J., Williams, S. P., & Kramer, L. J. (2004). <i>Synthetic vision enhanced surface operations and flight procedures rehearsal tools</i> (NASA/TP-2004-213008). Hampton, VA: NASA. |
| 7 | ES10a1 | Arthur, J., Prinzel, L. J., Bailey, R. E., Shelton, K. J., Williams, S. P., Kramer, L. J., & Norman, R. M. (2008). <i>Head-worn display concepts for surface operations for commercial aircraft</i> . (NASA/TP-2008-215321). Hampton, VA: NASA. |
| 8 | ES11a | Bailey, R. E., Kramer, L. J., & Prinzel, L. J. (2006). Crew and display concepts evaluation for synthetic enhanced vision systems. <i>Proceedings of SPIE</i> , vol. 6226. |
| 9 | ES12a | Beringer, D. B., & Harris, H. C. (1999). Automation in general |

- aviation: Two studies of pilot responses to autopilot malfunctions. *The International Journal of Aviation Psychology*, 9(2), 155-174.
- 10 Illi6a Earing, R. M. (1978). *The effects of expectancy and training on adaptation and detection of abrupt transition in control order*. Unpublished master's thesis, University of Illinois at Urbana-Champaign, Illinois.
- 11 Illi1 Fadden, S., Ververs, P. M., & Wickens, C. D. (2001). Pathway HUDS: Are they viable? *Human Factors*, 43, 173-193. (Study 1)
- 12 Illi2 Fadden, S., Ververs, P. M., & Wickens, C. D. (2001). Pathway HUDS: Are they viable? *Human Factors*, 43, 173-193. (Study 2)
- 13 Illi3 Fadden, S., Ververs, P. M., & Wickens, C. D. (2001). Pathway HUDS: Are they viable? *Human Factors*, 43, 173-193. (Study 3)
- 14 Illi4 Fadden, S., Ververs, P. M., & Wickens, C. D. (2001). Pathway HUDS: Are they viable? *Human Factors*, 43, 173-193. (Study 4)
- 15 BH1a Fischer, E., Haines, R. F., & Price, T. (1980). *Cognitive issues in head-up displays* (NASA Technical Paper 1711). Washington, DC: NASA.
- 16 BH9 Foyle, D. C., Hooey, B. L., Wilson, J. R., & Johnson, W. A. (2002). HUD symbology for surface operations: Command guidance vs. situation guidance formats. *SAE Transactions: Journal of Aerospace*, 111, 647-658.
- 17 ES2 Helleberg, J. (2005). *Effects of a final approach runway occupancy signal (FAROS) on pilots' flight path tracking, traffic detection, and air traffic control communications*. McLean, VA: The MITRE Corporation.
- 18 ES13i Hofer, E. F., Braune, R. J., Boucek, G. P., & Pfaff, T. A. (2001). *Attention switching between near and far domains: An exploratory study of pilots' attention switching with head-up and head-down* (D6-36668). The Boeing Company, October 18, 2001.
- 19 ES1a Hooey, B. L., Foyle, D. C., & Andre, A. D. (2000). Integration of cockpit displays for surface operations: The final stage of a human-centered design approach. *SAE Transactions: Journal of Aerospace*, 109, 1053-1065.

Appendix J – Coded List of Off-Nominal Studies Used

- 20 SVS7a Iani, C., & Wickens, C.D. (2007). Factors affecting task management in aviation. *Human Factors*, 49, 16-24.
- 21 SVS8a Johnson, N. R., Wiegmann, D. A., & Wickens, C. D. (2005). *Effects of advanced cockpit displays on general aviation pilots' decisions to continue visual flight rules (VFR) flight into instrument meteorological conditions (IMC)* (AFHD-05-18/NASA-05-6). Savoy, IL: University of Illinois, Aviation Human Factors Division.
- 22 AS19a Latorella, K. A. (1998). Effects of modality on interrupted flight deck performance: Implications for datalink. *Proceedings of the Human Factors and Ergonomics Society 42nd Annual Meeting*, 42, 87-91.
- 23 AS21 Lorenz, B., & Biella, M. (2006). Evaluation of onboard taxi guidance support on pilot performance in airport surface navigation. *Proceedings of the Human Factors and Ergonomics Society 50th Annual Meeting*, 111-115.
- 24 ES8a Mosier, K. L., Skitka, L. J., Heers, S., & Burdick, M. (1998). Automation bias: Decision making and performance in high-tech cockpits. *The International Journal of Aviation Psychology*, 8(1), 47-63.
- 25 AS22a Olson, W. A., & Sarter, N.B. (1999). Informed consent in distributed cognitive systems: The role of conflict type, time pressure, and trust. *Proceedings of the 18th Digital Avionics Systems Conference*, 1, 4.B.1-1-4.B.1-6.
- 26 AS23a Prinzel, L. J., Hughes, M. F., Arthur, J. J., Kramer, L. J., Glaab, L. J., Bailey, R. E., Parrish, R. V., & Uenking, M. D. (2003). Synthetic vision CFIT experiments for GA and commercial aircraft: A picture is worth a thousand lives. *Proceedings of the Human Factors and Ergonomics Society 47th Annual Meeting*, 164-168.
- 27 ES25 Prinzel, L. J., Kramer, L. J., & Bailey, R. (2007). *Going below minimums: The efficacy of display enhanced/synthetic vision fusion for go-around decisions during non-normal operations* (NASA/TP 20070018289). Hampton, VA: NASA.
- 28 AS13 Prinzel, L. J., Kramer, L. J., Arthur, J. J., Bailey, R. E., & Comstock, R. J., (2004). Comparison of head-up and head-down “Highway in the Sky” tunnel and guidance concepts for synthetic vision displays. *Proceedings of the Human Factors*

and Ergonomics Society 48th Annual Meeting, 11-15.

- 29 ES22a Prinzel, L. J., Kramer, L. J., Bailey, R. E., & Sweeters, J. L. (2005). Development and evaluation of 2-D and 3-D exocentric synthetic vision navigation display concepts for commercial aircraft. *Proceedings of SPIE, 5802*(207).
- 30 BH7a Stevens, S. M., Goldsmith, T. E., Johnson, P. D., & Moulton, J. B. (2007). *Skill decay on takeoffs as a result of varying degrees of expectancy*. Presented at the 14th International Symposium on Aviation Psychology, Dayton, OH.
- 31 AS4a Stevens, S. M., Goldsmith, T. E., & Johnson, P. J. (2007). Performance differences on rejected takeoffs as a function of expectancy. *Proceedings of the Human Factors and Ergonomics Society 51st Annual Meeting, 51*, 80-84.
- 33 BH2 Weintraub, D. J., Haines, R. F., & Randle, R., (1985). *Head-up display (HUD) utility, II: Runway to HUD transitions monitoring eye focus and decision times*. In Proceedings of the 29th Annual Meeting of the Human Factors and Ergonomics Society. Santa Monica: HFES.
- 34 SVS3a Wickens, C. D., Alexander, A. L., Thomas, L. C., Horrey, W. J., Nunes, A., Hardy, T. J., & Zheng, X. S. (2004). *Traffic and flight guidance depiction on a synthetic vision system display: The effects of clutter on performance and visual attention allocation* (Technical Report AHFD-04-10/NASA(HPM)-04-1). Savoy, IL: Aviation Human Factors Division.
- 35 Illi 5 Wickens, C.D., Helleberg, J., & Xu, X. (2002). Pilot maneuver choice and workload in free flight. *Human Factors, 44*(2), 171-188.

CHAPTER 16. APPENDIX K. NRA NNX08AE87A GENERATED PUBLICATIONS**Publication List from NRA NNX08AE87A****Brian F. Gore, Ph.D.**

Wickens, C.D., Hooey, B.L., Gore, B.F., Sebok, A., & Koenecke, C. (2009). Identifying black swans in NextGen: Predicting human performance in off-nominal conditions. *Human Factors*, 51(5), 638-651.

Wickens, C.D., Hooey, B.L., Gore, B.F., Sebok, A., Koenecke, C., & Salud, E. (2009). Predicting pilot performance in off-nominal conditions: A meta-analysis and model validation. Proceedings of the 53rd Annual *Human Factors and Ergonomics Society General Meeting*, October 19-23, San Antonio, TX.

Hooey, B. L., Wickens, C. D., Salud, E., Sebok, A., Hutchins, S., & Gore, B. F. (2009). Predicting the unpredictable: Estimating human performance parameters for off-nominal events. Proceedings of the 15th International Symposium on Aviation Psychology. Dayton, OH: Wright State University.

Gore, B.F., Hooey, B.L., Wickens, C., Sebok, A., Hutchins, S., Salud, E., Small, R., Koenecke, C., & Bzostek, J. (2009). Identification of NextGen air traffic control and pilot performance parameters for human performance model development in the transitional airspace. NASA Final Report: NRA #NNX08AE87A, San Jose State University: San Jose.

Report Documentation Page

Form Approved
OMB No. 0704-0188

The public reporting burden for this collection of information is estimated to average 1 hour per response, including the time for reviewing instructions, searching existing data sources, gathering and maintaining the data needed, and completing and reviewing the collection of information. Send comments regarding this burden estimate or any other aspect of this collection of information, including suggestions for reducing this burden, to Department of Defense, Washington Headquarters Services, Directorate for Information Operations and Reports (0704-0188), 1215 Jefferson Davis Highway, Suite 1204, Arlington, VA 22202-4302. Respondents should be aware that notwithstanding any other provision of law, no person shall be subject to any penalty for failing to comply with a collection of information if it does not display a currently valid OMB control number.
PLEASE DO NOT RETURN YOUR FORM TO THE ABOVE ADDRESS.

| | | | | | |
|--|-----------------------------|--|--|---------------------------------------|--|
| 1. REPORT DATE (DD-MM-YY) 01-12-2010 | | 2. REPORT TYPE Contractor Report | | 3. DATES COVERED (From – To) | |
| 4. TITLE AND SUBTITLE Identification of Pilot Performance Parameters for Human Performance Models of Off-Nominal Events in the NextGen Environment | | | 5a. CONTRACT NUMBER NNX08AE87A 5b. GRANT NUMBER 5c. PROGRAM ELEMENT NUMBER 5d. PROJECT NUMBER 5e. TASK NUMBER 5f. WORK UNIT NUMBER | | |
| 6. AUTHOR(S) Brian F. Gore; Becky L. Hooey; Christopher D. Wickens; Angelia Sebok; Shaun Hutchins; Ellen Salud; Ronald Small; Correy Koenecke; Julie Bzostek | | | | | |
| 7. PERFORMING ORGANIZATION NAME(S) AND ADDRESSES(ES) NASA Ames Research Center Moffett Field, California 94035-1000 | | | 8. PERFORMING ORGANIZATION REPORT NUMBER TH-087 | | |
| 9. SPONSORING/MONITORING AGENCY NAME(S) AND ADDRESS(ES) National Aeronautics and Space Administration Washington, DC 20546-0001 | | | 10. SPONSORING/MONITOR'S ACRONYM(S) NASA | | |
| | | | 11. SPONSORING/MONITORING REPORT NUMBER NASA/CR—2010-216411 | | |
| 12. DISTRIBUTION/AVAILABILITY STATEMENT Unclassified—Unlimited Subject Category: 03 Availability: NASA CASI (301) 621-0390 Distribution: Nonstandard | | | | | |
| 13. SUPPLEMENTARY NOTES Point of Contact: Brian Gore, Ames Research Center, MS 262-4, Moffett Field, CA 94035; 650-604-2542 | | | | | |
| 14. ABSTRACT Human Performance Models (HPMs) of off-nominal scenarios, with appropriate and valid input parameters, can lead to a detailed understanding of operator performance, provide insight into the root causes of human error, and determine conditions of latent error, which, if left unchecked in system design conditions, may lead to errors. Testing advanced system concepts in the relative safety of a HPM is both cost- and time-efficient and, when used in concert with empirical research, is a system design concept that is likely to achieve maximum human performance. Such an approach will produce systems that are safer, more efficiently used by the operator, more robust to errors and inadvertent misuse, and more likely to bridge the gap when moving from an existing system to a future system. The goals of this research are to characterize human-system interactions for future technologies needed to enable the NextGen, and to identify candidate scenarios and related data parameters required to develop HPMs. These models can be used to predict human-system performance associated with the new roles, procedures, and technologies characteristic of NextGen operations. | | | | | |
| 15. SUBJECT TERMS Pilot performance parameters, NextGen Human Performance Models, Off Nominal operations | | | | | |
| 16. SECURITY CLASSIFICATION OF: | | | 17. LIMITATION OF ABSTRACT UU | 18. NUMBER OF PAGES 262 | 19a. NAME OF RESPONSIBLE PERSON STI Help Desk at email: help@sti.nasa.gov |
| a. REPORT U | b. ABSTRACT U | c. THIS PAGE U | | | 19b. TELEPHONE NUMBER (Include area code) STI Help Desk at: (301) 621-0390 |

