

Design and Control of an Ultraviolet Water Disinfection System Powered by Photovoltaic Source

Khira Ouelhazi,

Laboratory of Industrial Systems
Engineering and Renewable
Energies, Higher National School of
Engineers of Tunis (ENSIT)
Khira.ouelhaz@yahoo.fr.

Abderrahmen BEN CHAABENE

Laboratory of Industrial Systems
Engineering and Renewable
Energies, Higher National School of
Engineers of Tunis (ENSIT)
Abd.chaabene@yahoo.fr

Anis Sellami

Laboratory of Industrial Systems
Engineering and Renewable
Energies, Higher National School of
Engineers of Tunis (ENSIT)
anis.sellami@esstt.rnu.tn

Abstract—Nowadays there are several methods to disinfect water for drinking and domestic uses from harmful microorganisms. Among them, the use of ultraviolet irradiation disinfection knew a strong growth these last years. To provide a large quantities of disinfected water, the UV- technique requires an enormous amount of electrical energy consumed by the UV reactor. Therefore, it is necessary to look for other sources of energy. The use of photovoltaic sources in water treatment domain is one of the most important renewable energy applications. The main problem with the use of PV sources is the intermittence of solar energy and its dependence with climatic conditions, thus, it is necessary to develop efficient control techniques for the Photovoltaic, Ultra Violet (PV-UV) disinfection processes; on the one hand, to improve the quality of the various parameters of the disinfected water; on the other hand, to adapt UV-water disinfection systems dynamics with source variations.

The present paper deals with two contributions: the first is to propose a coupling of the UV water disinfection systems to photovoltaic sources to minimize the production cost. The second consists on a development of a novel tracking control technique based on Variable Structure Model Reference Adaptive Control (VSMRAC). This technique requires the system to follow a reference model by adjusting its dynamic to the variations of the PV sources. To show perfect following and the efficiency of the control technique, simulations and experimental results have been carried out using Matlab software and a real PV-UV water disinfection prototype.

Keywords—UV-Water disinfection system, sliding mode Control, MIMO systems, Modeling

INTRODUCTION

As water is customarily used and needed in large quantities, it is important to minimize energy consumption whenever possible. These last years, there are several initiatives to support the use of renewable or green energies in water domain [1], [2]. Furthermore, some agglomerations, far from the water

distribution network, are fed by individual water sources. These sources are often contaminated and unsuitable for drinking or irrigation, because of the high biological contagion in sensitive germs. Consequently, they could be factors of certain disease transmission. One alternative that has received considerable interest these last years and was widely used in the treatment of drinking water is the disinfection with UV radiation [3], [4]. Generally, most current UV disinfection systems employ tubular germicidal lamps surrounded by a quartz tube submerged in a chamber through which the fluid flows. The UV source of radiation used is usually a low-pressure mercury arc lamp that generates short-wave ultraviolet in the region of 253.7 nm powered by alternative current source through an electronic ballast which generates a high energy consumption depending on the amount of water to be disinfected[5], [6], [7]. In addition, several parameters can influence the rate of inactivation of microorganisms such as the physic-chemical parameters (pH, temperature etc.), the UV dose applied, the UV-water contact time, the number and the type of microorganisms existing in the water [8], [9], [10], therefore, several models have been developed in literature to establish a control strategy [11],[12]. The suitable model for simulations, dynamic analysis and optimization is that developed in [13]. In order to ensure an optimum operating condition the literature presented different methods such as the extraction of the maximum power value by MPPT control algorithm [14], [15], [16], [17]. Among many developed control strategies our proposed control technique is characterized by the combination of the properties of the adaptive control and the variable structure control. The principle of this technique is to impose on the controlled system to follow a reference model whose characteristics are previously chosen in order to improve the operating performance. This paper is organized as follows: The material and methods section is devoted to the description of the PV-UV water disinfection system, to the theoretical elements of variable structure model reference adaptive control (VSMRAC) algorithms and to a background on PV sources . the second deals with the main simulated and experimental results than the most interesting conclusions.

MATERIAL AND METHODS

PV-UV WATER DISINFECTION SYSTEM

II.1. PV-UV WATER DISINFECTION SYSTEM

II.1.1. PRINCIPLE OF UV RADIATION DISINFECTION

As detailed in [13], Ultraviolet light is characterized by wavelengths between 100 and 400 nm. The UV strip UVC range of 200 to 280 nm, where the wavelengths are the most effective for disinfection. The maximum efficiency of UV disinfection corresponds to an energy output of 253.7 nm which represents the peak absorption of UV radiation by microorganisms. Ultraviolet rays, similar to UV rays of the sun but stronger, alter the nucleic acid (DNA) of microbes such as viruses, bacteria, molds or parasites, so that they cannot reproduce and are considered inactivated. The effectiveness of disinfection is mainly influenced by the design of the experimental system in which disinfection is performed. Most current UV disinfection systems allow fluid to flow through a chamber containing a tubular germicidal lamps with a quartz tube. The UV source of radiation used is usually a low-pressure mercury arc lamp that generates short-wave ultraviolet light in the indicated region. Discharge lamps require certain electrical circuits generated by electronic ballasts to start the discharge lamp, to regulate the lamp cycle and to control the necessary electric current.

II.1.2. Description of the PV- UV disinfection system

Our PV-UV water disinfection system consists of a closed cylindrical stainless steel reactor of annular cross-section. It is equipped with a single low-pressure mercury discharge lamp placed in the axis of the irradiation room and equipped by a clean quartz sleeve for the lamp seal and protection. The tab.1 resumes the reactor dimensions. The lamp was fed via an electronic ballast consisting of a single-phase rectifier, a converter transistor producing from 25 kHz to 100 kHz at its output and a resonant circuit to obtain the lighting of the lamp [13]. The electronic ballast is fed by a photovoltaic panel through a DC\DC boost converter to vary the voltage and a DC\AC converter to provide the AC voltage to the electronic ballast for supplying the gas discharge lamp. The synoptic diagram of the PV-UV water disinfecting system is illustrated in Fig.1.

The schematic diagram of the PV-UV water disinfection unit is described in the following Fig. 2.

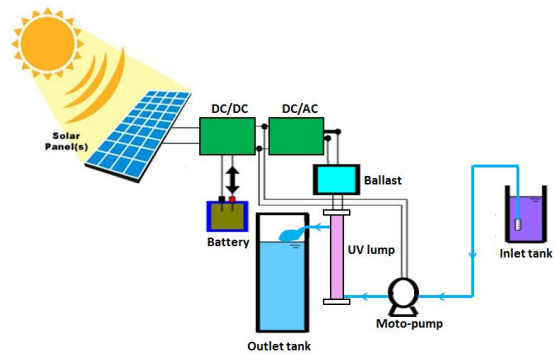

Fig. 1. Synoptic diagram of the PV-UV water disinfecting system

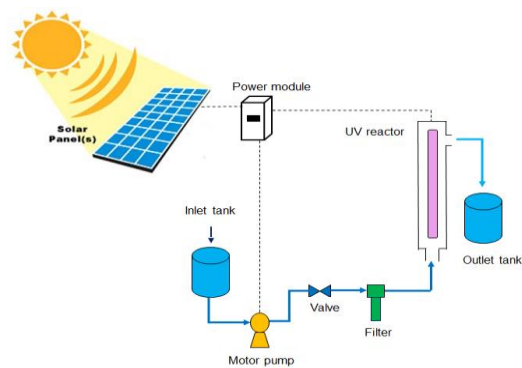

Fig. 2. Schematic diagram of the UV disinfection system

I.1.3. The PV generator

To power the UV-disinfection systems by solar energy in an easily and inexhaustible way, we have to use PV generators. For the best exploitation of this energy and a continuous product of water, we must install the recharged batteries. The PV generator consists of an array of photovoltaic cell modules parallel combination to provide the desired DC voltage and current. The coupling of the battery with the PV generator is realized through a charge regulator, the electrical model of the PV generator is shown in Fig. 3.

In this model of PV generator the photovoltaic current intensity is given by the following expressions detailed in [19].

$$V_D = V_P + R_S I_P$$

$$I_P = I_{ph} - I_D - (V_D/R_{sh}) \tag{1}$$

$$I_P = I_{ph} - I_s [\exp(qV_D/AKT) - 1] - \frac{V_D}{R_{sh}}$$

I_P : Photo current (A)

I_S : Reverse saturation current (A)

Q : Elementary charge (C)

V_P : Terminal voltage (V)

V_D : Diode voltage (V)

R_{SH} : Shunt resistance caused by the cell surface state (Ω)

R_S Serial resistance caused by the based resistance of the junction face (Ω)

K : Boltzmann constant = $1.38064852(79) \times 10^{-23}$ J/K.T T: Absolute temperature (K)

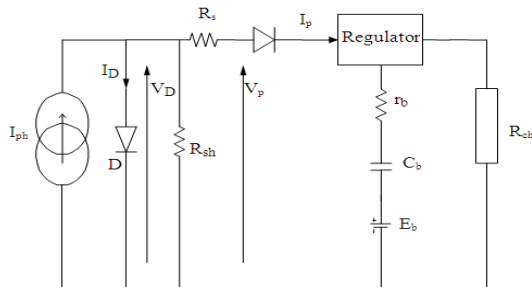

Fig. 3. The energetic system equivalent diagram

II.1.4. THE DISINFECTION SYSTEM STATE SPACE MODEL

We have developed in [13] the state space model of the PV-UV water disinfection system. It is considered as a Multi-Input, Multi-Output (MIMO) system with two inputs parameters or manipulated variables which are respectively the feed flow Q and the UV lamp intensity I and two outputs parameters which are respectively the UV dose D and the bacterial reduction A. By experimental serials of measurements, the state space representation of the PV-UV disinfection system and its reference model are given by the following equations.

$$\begin{cases} \dot{X} = AX + BU \\ Y = CX + DU \end{cases} \quad (2)$$

$$\begin{cases} \dot{X}_m = A_m X_m + B_m V \\ Y_m = C_m X_m + D_m V \end{cases}$$

$$X = \begin{bmatrix} X_1 \\ X_2 \\ X_3 \\ X_4 \end{bmatrix} \quad Y = \begin{bmatrix} D \\ M \end{bmatrix} \quad U = \begin{bmatrix} I \\ Q \end{bmatrix} \quad (3)$$

$$X_1 = D \quad X_2 = \frac{dD}{dt} \quad X_3 = M$$

$$X_4 = \frac{dM}{dt} \text{ Matrices A, B and C are defined as}$$

follows:

$$A = \begin{pmatrix} 0 & 1 & 0 & 0 \\ -6.02 & -6.77 & 0 & 0 \\ 0 & 0 & -0.56 & 1 \\ 0 & 0 & -0.70 & -1.67 \end{pmatrix}$$

$$A_m = \begin{pmatrix} 0 & 1.1 & 0 & 0 \\ -5.42 & -6.1 & 0 & 0 \\ 0 & 0 & -0.47 & 1.10 \\ 0 & 0 & -0.62 & -1.50 \end{pmatrix} \quad (4)$$

$$C = \begin{pmatrix} 1 & 0 & 0 & 0 \\ 0 & 0 & 1 & 0 \end{pmatrix}$$

$$B_m = B = \begin{bmatrix} 1 & 0 \\ 0 & 98.86 \\ 0 & 1.56 \\ 0.55 & 0 \end{bmatrix}$$

II.2. VSMRA CONTROL STRATEGY

II.2.1. THEORETICAL ELEMENTS

I.As we have detailed in [20], [21], [22], the error vector e between the process state space vector X and the reference state space vector X_m described in Eq. (2) is:

$$e = X - X_m \quad (5)$$

The purpose is to form the control vector U which forces the error elements to tend asymptotically to zero at a finite time.

The control vector U is generated introducing control law:

$$U = \psi X + V \quad (6)$$

ψ is the feedback matrix with the dimension (m x n). The elements Ψ_{ij} are switching functions adjusted using a variable structure approach.

The model of the entire system in the error state space equation is obtained as:

$$\dot{e} = A_m e + \dot{B}(\psi - \theta^*)X \quad (7)$$

To ensure stability, we consider a Lyapunov function of the form:

$$\Lambda = e^T P e \quad (8)$$

Where, P is a positive definite and symmetric matrix, consequently we have:

$$A_m^T P + P A_m = -Q_0 = -B_m^T B_m \quad (9)$$

Differentiating (8) with respect to time along the trajectory (7) yields:

$$\dot{\Lambda} = -e^T Q_0 e + 2e^T P B [(\psi - \theta^*) X] \quad (10)$$

$$\dot{\Lambda} = -e^T Q_0 e + 2 \sum_{i=1}^m \left\{ b_i^T P e \sum_{j=1}^n (\psi_{ij} - \theta_{ij}^*) x_j \right\} \quad (11)$$

The switching functions are defined as:

$$\psi_{ij} = -\bar{\theta}_{ij} \operatorname{sgn}(b_i^T P e x_j) \quad (12)$$

With: $\bar{\theta}_{ij} > |\theta_{ij}^*|$

The error vector and the state vector are both switched. They represent the components of a matrix Ψ that ensures rapid attainability and reinforces the stability of the system by using a Lyapunov function.

By introducing this expression into (11), we obtain:

$$\dot{\Lambda} = -e^T Q_0 e + 2 \sum_{i=1}^m \left\{ b_i^T P e \sum_{j=1}^n \left(-\bar{\theta}_{ij} \operatorname{sgn}(b_i^T P e x_j) - \theta_{ij}^* \right) x_j \right\} \quad (13)$$

The terms in the summation are always positive, therefore and regarding (8) it can be concluded that decreases at least exponentially.

Fig.4 shows the chronology of the calculation steps of the following control were the switching function and the control law are calculated in order to decrease the following error, than forces the system to follow its reference model.

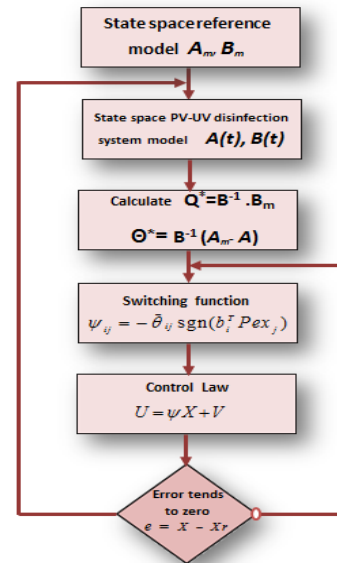

Fig. 4. Algorithm for calculating the VSMRA control of the PV-UV disinfection system

Figures 5 and 6 show respectively the following control block diagram and the Matlab Simulink model of the PV-UV disinfection system corresponding to the described algorithm.

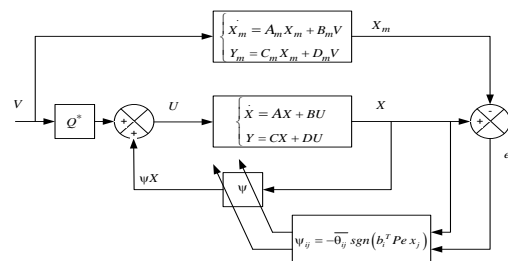

Fig. 5. Model reference following control algorithm block diagram

TAB. 1: UV254 DISINFECTION REACTOR DIMENSIONS COMPONENTS

	Long (m)	Internal Diameter (m)	External Diameter (m)	Lamp Power (watts)
Stainless still Tube	0.7	0.06	0.06	-
Lamp	0.6	0.02	0.02	55
Tube in Quartz	0.65	0.025	-	-

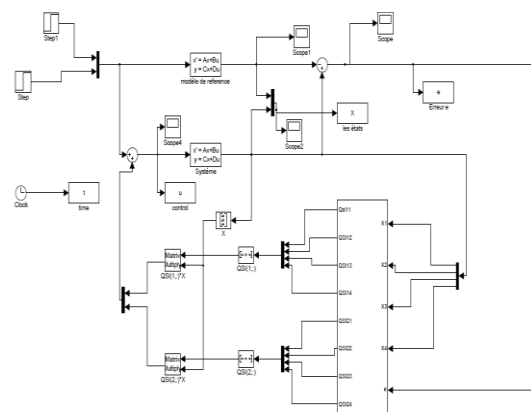

Fig.6. Matlab Simulink model of the PV-UV following control

II.2.2. PARAMETERS VALUES

Using values of model matrices given in Eq.(4), the matrices Q^* , θ^* were calculated as follows

$$\theta^* = B^{-1}[A_m - A] = \begin{pmatrix} 0 & 0.0768 & 0.0338 & 0.0718 \\ 0.0061 & 0.0068 & 0 & 0 \end{pmatrix} \quad (14)$$

switching functions Ψ_{ij} of the matrix Ψ will be determined from θ_{ij}^* and the expression (12) with:

$$\bar{\theta} = \begin{pmatrix} 0 & 0.0845 & 0.0372 & 0.079 \\ 0.0067 & 0.0075 & 0 & 0 \end{pmatrix} \quad (15)$$

switching functions Ψ_{ij} of the matrix Ψ will be determined from θ_{ij}^* and the expression (12) with:

III. SIMULATION AND EXPERIMENTAL RESULTS

III.1. SOLAR IRRADIATION

As we have determined in [1] in order to know the solar deposit, The Fig.7. shows the variation of solar irradiation. We can deduce that the available irradiance measured over two days test is with important quantities (more than 500 W.m-2 while at least 8 hours a day).

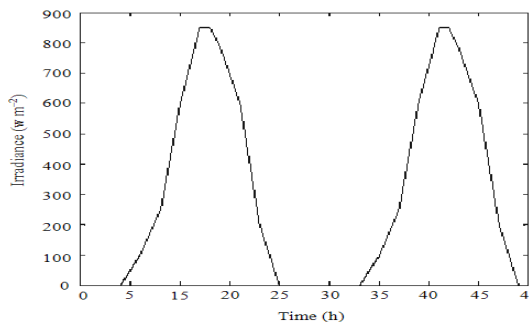

Fig.7. The Measured solar Irradiance PV-UV water disinfection dynamic

Figures 8(a) and 8(b) show respectively the step responses of the UV dose D and the bacterial abatement A, When the reference trajectory is characterized by a slow dynamic. These results show perfect model following at a finite time. Fig. 9, shows tracking error values which evolve to zero in a finite time for the two parameters A and D. This is the consequence of the performances combination of the real time adjusting of the adaptive control with the robustness of the Variable Structure control.

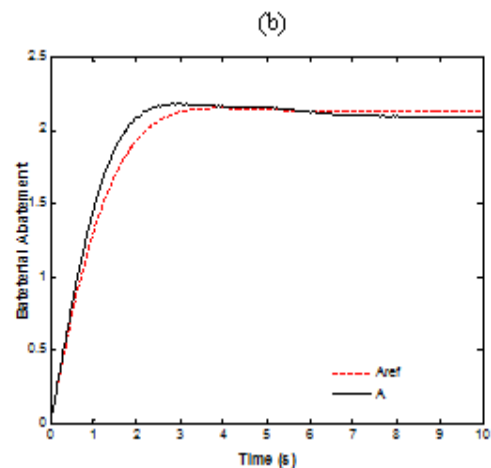
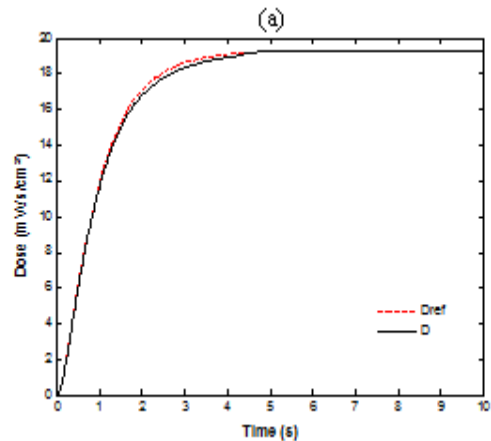

Fig. 8. Step response of the UV dose (a) and the bacterial abatement(b)

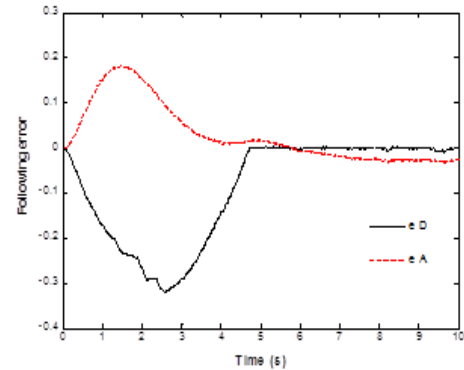

Fig. 9. The UV dose and The bacterial abatement following error behavior

III.2. VSMRA CONTROL PERFORMANCES

To study the following performances, we have chosen a fast variable reference model and show if the system can follow quickly its reference model with two frequencies f_1 and f_2 where ($f_1 > f_2$). The trajectory of the reference model is now with fast variable dynamic; this makes the tracking quite difficult.

Fig. 10 .(a) and (b) shows a perfect following for the UV dose D and the bacterial abatement A even in the presence of a variable reference model (frequency f_1) with a following error value is evolving around 4% as it

is shown in figure 11.

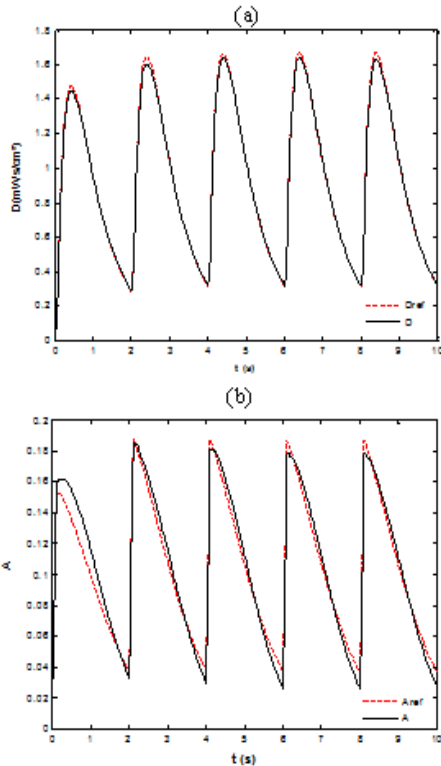

Fig.10. the UV dose (a) and the bacterial abatement (b) behavior with fast variable reference model (frequency f1)

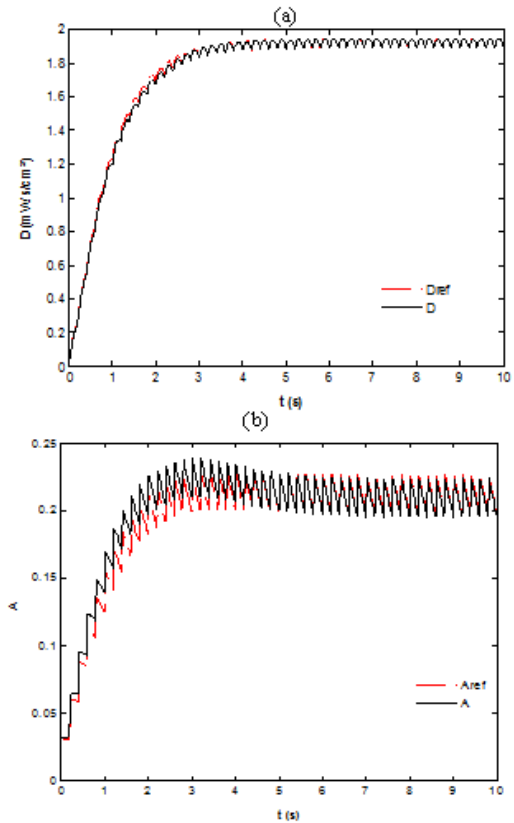

Fig.12. the UV dose (a) and the bacterial abatement (b) behavior with fast variable reference model (frequency f2)

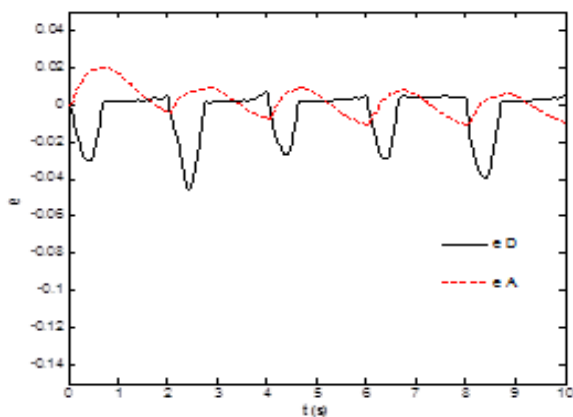

Fig. 11. The UV dose and The bacterial abatement following error behavior with fast variable reference model (frequency f1)

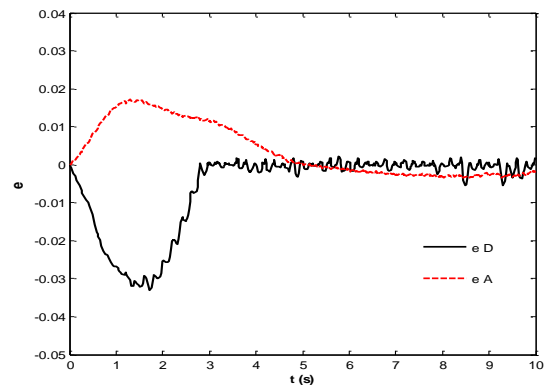

Fig. 13. The UV dose and The bacterial abatement following error behavior with fast variable reference model (frequency f2)

Fig. 12 .(a) and (b) shows also a perfect following for the UV dose D and the bacterial abatement A even in the presence of a variable reference model for a higher frequency f2 with a following error value starting around 3% as it is shown in figure 13 then tends to zero in a relatively short time.

From previous figures, it can be seen that the tracking error tends to zero in a relatively short time relative to the frequency of variation of the reference signals. The performances of the following speed is due to the adaptation in real time whereas the stability and the robustness are due to the appearance of the variable structure control.

IV.CONCLUSION

In this paper, a coupling between a photovoltaic generator and an Ultraviolet disinfection system is proposed. A new control strategy based on variable structure model reference adaptive control of the PV-UV water disinfection system is also presented. The established control technique is characterized by its zero output error tracking at a finite time. The problem of dynamics variation of the PV-UV system due to the intermittency of the PV source is solved by the tracking of the reference model. The theoretical development shows the performance of this control technique in terms of tracking stability and speed.

To validate these performances, the proposed control technique was simulated and a small PV-UV water disinfection system is tested. It has been shown that there is a significant correlation between the experimental and simulated results. The use of photovoltaic energy in the field of water disinfection by UV radiation proves to be very interesting in terms of energy saving. As a perspective of this work, a design study for UV-disinfection systems of higher capacity will be carried out to minimize the production cost and to protect the environment.

ACKNOWLEDGMENT

The authors gratefully acknowledge the support of professor H. Abdennaceur and all the team of the wastewater pilot plant El Menzeh I for their great and effectively contribution to achieve this work.

REFERENCES

[1] A. B. Chaabene, M.F. Elkaroui, A. Sellami, "Efficient design of a photovoltaic water pumping and treatment system", *American Journal of Engineering and Applied Sciences*, vol. 6 (2), pp. 226-232, 2013.

[2] A. B. Chaabene, K.Ouelhazi, A. Sellami, "Novel Design and Modeling of a Photovoltaic Hydro Electromagnetic Reverse Osmosis (PV-HEMRO) Desalination System", *Journal of Desalination and Water Treatment*, 66 (March 2017) 36–41.

[3] G. D. Harris, V. D. Adams, D. L. Sorensen, M. S. Curtis, "Ultraviolet inactivation of selected bacteria and viruses with photo reactivation of the bacteria", *Journal of Water Research*, vol. 21, pp. 687–692, 1987.

[4] J.J.V. Colmenares, A. Acevedo, E. Nebot, "Effect of recirculation and initial concentration of microorganisms on the disinfection kinetics of *Escherichia coli*", *Desalination*, vol. 280, pp. 20–26, 2011.

[5] K. Chiu, D. A. Lyn, P. Savoye, E. R. Blatchley III, "Integrated UV disinfection model based on particle tracking", *J. Environ. Eng.*, vol. 125, pp. 7–16, 1999.

[6] M. Brahmi, H. Abdennaceur, "Ultraviolet radiation for microorganism inactivation in wastewater", *J. Environ. Prot.*, vol. 3, pp. 194–202, 2012.

[7] R. G. Qualls, J. D. Johnson, "Modeling and efficiency of ultraviolet disinfection systems", *Journal of Water Research*, vol. 19, pp. 1039–1046, 1985.

[8] M. Brahmi, N. H. Belhadi, H. Hamdi, A. Hassen, "Modeling of secondary treated wastewater disinfection by UV irradiation: Effects of suspended solids content", *J. Environ. Sci.*, vol. 22, pp. 1218–1224, 2010.

[9] M. Brahmi, H. Abdennaceur, "Ultraviolet radiation for microorganism inactivation in wastewater", *J. Environ. Prot.*, vol. 3, pp. 194–202, 2012.

[10] R. G. Qualls, J. D. Johnson, "Modeling and efficiency of ultraviolet disinfection systems," *Water Res.*, vol. 19, pp. 1039–1046, 1985.

[11] N. Zitouni, R. Andoulsi, A. Sellami, A.Mami, H. Abdennaceur, "Modelling of Non-Linear Pilot Disinfection Water System: ABondGraphApproach", *Leonardo Journal of Sciences*, vol. 11(20), pp. 15–30, 2012.

[12] N. Zitouni, R. Andoulsi, A. Sellami, A.Mami, "Bond Graph modeling of a UV water disinfection pilot fed by photovoltaic source", *International Journal on Engineering Applications*, vol. 3(5), pp.149-157, 2015.

[13] K.Ouelhazi, A. B. Chaabene, A. Sellami, H. Abdennaceur, "Multivariable Model of an Ultraviolet Water Disinfection System", *Journal of Desalination and Water Treatment*, vol. 67, pp. 89–96, 2017.

[14] M. Hlaili and H. Mechergui, "Comparison of Different MPPT Algorithms with a Proposed One Using a Power Estimator for Grid Connected PV Systems", *International Journal of Photoenergy*, Volume 2014 (2014), Article ID 586503, 9 pages, 2014.

[15] A. Dolara, R. Faranda, and S. Leva, "Energy comparison of seven MPPT techniques for PV systems", *Journal of Electromagnetic Analysis and Applications*, vol. 1, no. 3, pp. 152–162, 2009.

[16] Chih-Lung Shen and Shih-Hsueh Yang, "Multi-Input Converter with MPPT Feature for Wind-PV Power Generation System", *International Journal of Photoenergy*, Volume 2013 (2013), Article ID 129254, 13 pages, 2013 <http://dx.doi.org/10.1155/2013/129254>.

[17] K. Chiu, D. A. Lyn, P. Savoye, E. R. Blatchley III, "Integrated UV disinfection model based on particle tracking", *J. Environ. Eng.*, vol. 125, pp. 7–16, 1999.

[18] J. A. Ramos-Hernanz, O. Barambones, J. M. Lopez-Guede, I. Zamora, P. Eguia, and M. Farhat, "Sliding Mode Real-Time Control of Photovoltaic Systems Using Neural Estimators", *International Journal of Photoenergy*, Volume 2016 (2016), Article ID 5214061, 16 pages, <http://dx.doi.org/10.1155/2016/5214061>.

[19] A.Ben Chaabene, R. Andoulsi, A. Sellami, R. Mhiri, "MIMO Modeling approach for a small photovoltaic reverse osmosis desalination system", *Journal of Applied Fluid Mechanics*, vol.4, pp. 35-41, 2011.

[20] A. B. Chaabene, A. Sellami, "A novel control of a Reverse Osmosis Desalination system powered by photovoltaic generator", in *EEE Xplore*, 2013, p. 1–6, DOI: 10.1109/ICEESA.2013.6578376.

[21] K. M. Ardeshir, "A variable structure MRAC for a class of MIMO systems", *International J. of Mechanical Systems Science and Engineering*, vol. 1 (2), pp. 4-79, 2007.

[22] K.Ouelhazi, A. B. Chaabene , A. Sellami, H. Abdennaceur, "Model Reference Following Control of a UV Water Disinfection System", Special issue -5th International Conference on Automatic & Signal Processing (ATS-2017) Proceedings of Engineering & Technology (PET) Volume 23, Special issue 2017. As for the fonts and the sizes of the headings, this manuscript in itself constitutes a good example.